

National Semiconductor is now part of
Texas Instruments.

Search <http://www.ti.com/> for the latest technical
information and details on our current products and services.

DS64MB201

Dual Lane 2:1/1:2 Mux/Buffer with Equalization and De-Emphasis

General Description

The DS64MB201 is a dual lane 2:1 multiplexer and 1:2 switch or fan-out buffer with signal conditioning suitable for SATA/SAS and other high-speed bus applications up to 6.4 Gbps. The device performs both receive equalization and transmit de-emphasis, allowing maximum flexibility of physical placement within a system. The receiver's continuous time linear equalizer (CTLE) provides a boost of up to +33 dB at 3 GHz and is capable of opening an input eye that is completely closed due to inter-symbol interference (ISI) induced by the interconnect medium. The transmitter features a programmable output de-emphasis driver and allows amplitude voltage levels to be selected from 600 mVp-p to 1200 mVp-p to suit multiple application scenarios. The signal conditioning settings are programmable via control pin settings or SMBus interface.

To enable seamless upgrade from SAS/SATA 3.0 Gbps to 6.0 Gbps data rates without compromising physical reach, DS64MB201 automatically detects the incoming data rate and selects the optimal de-emphasis pulse width. The device detects the out-of-band (OOB) idle and active signals of the SAS/SATA specification and passes through with minimum signal distortion.

Features

- Up to 6.4 Gbps dual lane 2:1 mux, 1:2 switch or fan-out
- Adjustable receive equalization up to +33 dB gain
- Adjustable transmit de-emphasis up to -12 dB
- Adjustable transmit VOD
- <0.25 UI of residual DJ at 6.4 Gbps with 40" FR4 trace
- SATA/SAS: OOB signal pass-through
- Adjustable electrical IDLE detect threshold
- Low power
- Signal conditioning programmable via pin selection or SMBus interface
- Single 2.5V supply operation
- >6 kV HBM ESD Rating
- 3.3V tolerant SMBus interface
- High speed signal flow-thru pinout package: 54-pin LLP (10 mm x 5.5 mm)

Applications

- SATA (1.5, 3.0 and 6 Gbps)
- SAS (1.5, 3.0 and 6 Gbps)
- XAUI (3.125 Gbps), RXAUI (6.25 Gbps)
- sRIO – Serial Rapid I/O
- Fibre Channel (4.25 Gbps)
- 10GBase-CX4, InfiniBand (SDR & DDR)
- FR-4 backplane traces

Typical Application

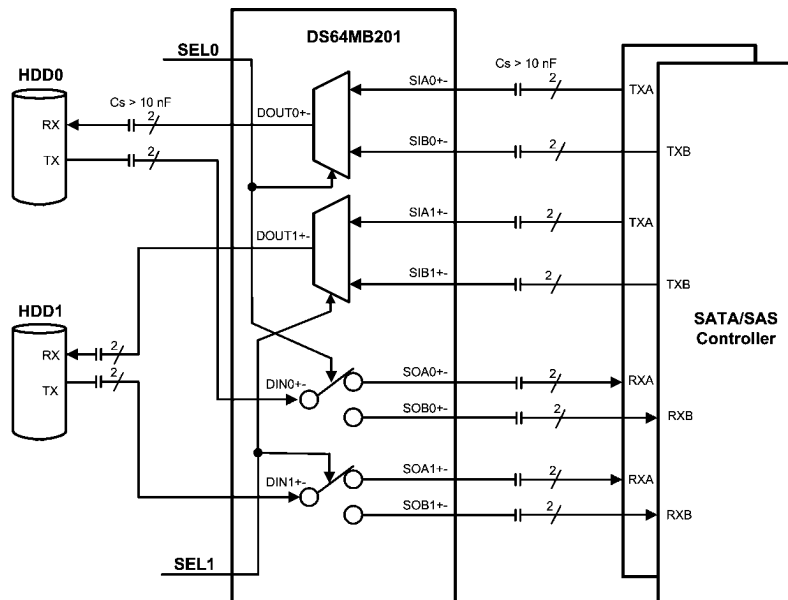

30076480

Pin Diagram

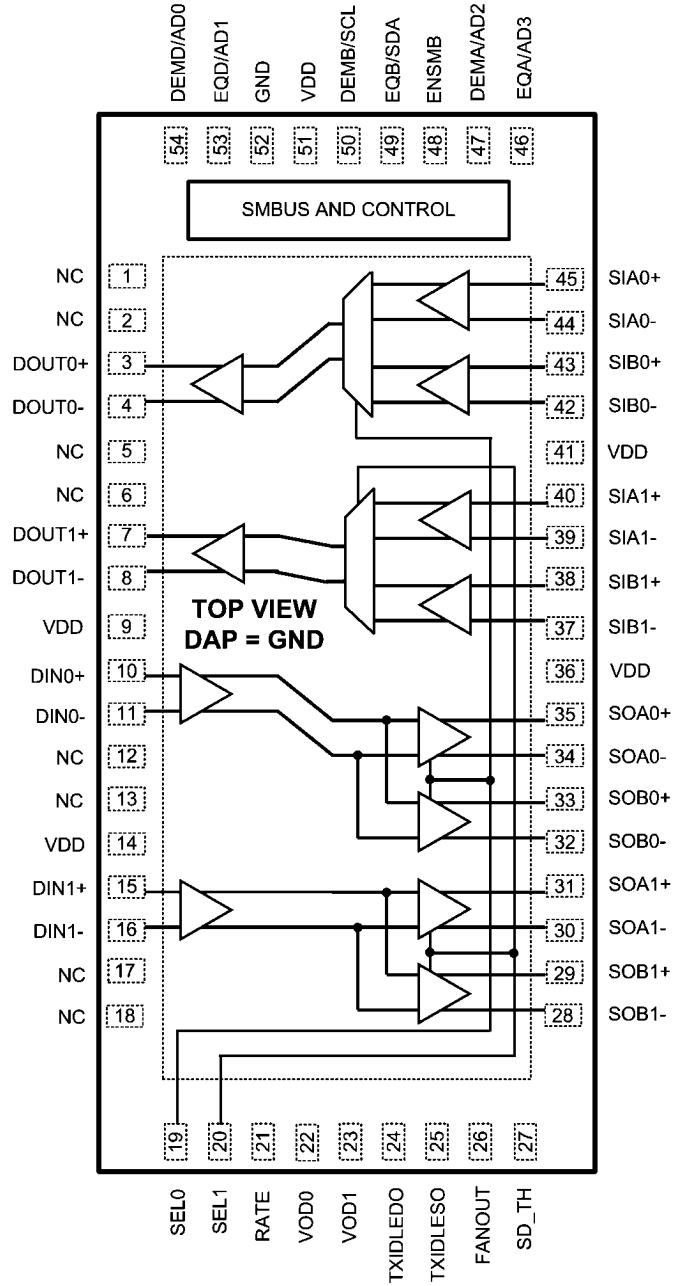

DS64MB201 Pin Diagram 54L LLP

300764505

Ordering Information

NSID	Qty	Spec	Package
DS64MB201SQ	Tape & Reel Supplied As 2,000 Units	NOPB	SQA54A
DS64MB201SQE	Tape & Reel Supplied As 250 Units	NOPB	SQA54A

Pin Descriptions

Pin Name	Pin Number	I/O, Type	Pin Description
Differential High Speed I/O's			
SIA0+, SIA0-, SIA1+, SIA1-	45, 44, 40, 39	I, CML	Inverting and non-inverting CML differential inputs to the equalizer. A gated on-chip 50Ω termination resistor connects SIA_n+ to VDD and SIA_n- to VDD when enabled.
SOA0+, SOA0-, SOA1+, SOA1-	35, 34, 31, 30	O	Inverting and non-inverting low power differential signaling 50Ω outputs with de-emphasis. Fully compatible with AC coupled CML inputs.
SIB0+, SIB0-, SIB1+, SIB1-	43, 42, 38, 37	I, CML	Inverting and non-inverting CML differential inputs to the equalizer. A gated on-chip 50Ω termination resistor connects SIB_n+ to VDD and SIB_n- to VDD when enabled.
SOB0+, SOB0-, SOB1+, SOB1-	33, 32, 29, 28	O	Inverting and non-inverting low power differential signaling 50Ω outputs with de-emphasis. Fully compatible with AC coupled CML inputs.
DIN0+, DIN0-, DIN1+, DIN1-	10, 11, 15, 16	I, CML	Inverting and non-inverting CML differential inputs to the equalizer. A gated on-chip 50Ω termination resistor connects SIB_n+ to VDD and SIB_n- to VDD when enabled.
DOU0+, DOU0-, DOU1+, DOU1-	3, 4, 7, 8	O	Inverting and non-inverting low power differential signaling 50Ω outputs with de-emphasis. Fully compatible with AC coupled CML inputs.
Control Pins — Shared (LVCMOS)			
ENSMB	48	I, LVCMOS w/ internal pull- down	System Management Bus (SMBus) enable pin. HIGH = Register Access: Provides access to internal digital registers to control such functions as equalization, de-emphasis, VOD, rate, channel powerdown, and idle detection threshold. LOW = Pin Mode: Access to the SMBus registers are disabled and control pins are used to program VOD, rate, idle detection, equalization and de-emphasis settings. Please refer to “SMBus configuration Registers” section and Electrical Characteristics - Serial Management Bus Interface for detailed information.
ENSMB = 1 (SMBUS MODE)			
SDA, SCL	49, 50	I, LVCMOS	ENSMB = 1 The SMBus SDA (data input/output bi-directional) and SCL (clock input) pins are enabled.
AD[3:0]	54, 53, 47, 46	I, LVCMOS w/ internal pull- down	ENSMB = 1 SMBus Slave Address Inputs. In SMBus mode, these pins are the user set SMBus slave address inputs.
ENSMB = 0 (NORMAL PIN MODE)			
EQA, EQB, EQD	46, 49, 53	I, Float, LVCMOS	EQA/B/D, 3-level input controls the level of equalization. EQA controls the level of equalization of the SIA0 and SIA1 inputs. EQB controls the level of equalization of the SIB0 and SIB1 inputs. EQD controls the level of equalization of the DIN0 and DIN1 inputs. The pins are active only when ENSMB is de-asserted (Low). When ENSMB goes high the SMBus control registers provide independent control of each lane. See Table 1
DEMA, DEMB, DEMD	47, 50, 54	I, Float, LVCMOS	DEMA/B/D, 3-level input controls the level of de-emphasis. DEMA controls the level of de-emphasis of the SOA0 and SOA1 outputs. DEMB controls the level of de-emphasis of the SOB0 and SOB1 outputs. DEMD controls the level of de-emphasis of the DOU0 and DOU1 outputs. The pins are active only when ENSMB is de-asserted (Low). When ENSMB goes High the SMBus control registers provide independent control of each lane. See Table 2

Pin Name	Pin Number	I/O, Type	Pin Description
Control Pins — Both Modes (LVCMOS)			
RATE	21	I, Float, LVCMOS	RATE, 3-level input controls the pulse width of de-emphasis of the output. RATE = 0 forces ~3 Gbps, RATE = 1 forces ~6 Gbps, RATE = Float enables auto rate detection. See Table 2
TXIDLEDO	24	I, Float, LVCMOS	TXIDLEDO, 3-level input controls the driver output. TXIDLEDO = 0 disables the signal detect/squelch function for DOUT. TXIDLEDO = 1 forces the DOUT to be muted (electrical idle). TXIDLEDO = Float enables the signal auto detect/squelch function for DOUT and the signal detect voltage threshold level can be adjusted using the SD_TH pin. See Table 3
TXIDLESO	25	I, Float, LVCMOS	TXIDLESO, 3-level input controls the driver output. TXIDLESO = 0 disables the signal detect/squelch function for SOUT. TXIDLESO = 1 forces the SOUT to be muted (electrical idle). TXIDLESO = Float enables the signal auto detect/squelch function for SOUT and the signal detect voltage threshold level can be adjusted using the SD_TH pin. See Table 3
FANOUT	26	I, LVCMOS w/ internal pull-down	FANOUT = 1 enables both A/B outputs for broadcast mode. FANOUT = 0 disables one of the outputs depending on the SEL0, SEL1 pin. See Table 5
SEL0, SEL1	19, 20	I, LVCMOS w/ internal pull-down	SEL0 is for lane 0, SEL1 is for lane 1 SEL0, SEL1 = 0 selects B input and B output. SEL0, SEL1 = 1 selects A input and A output. See Table 5
VOD0, VOD1	22, 23	I, LVCMOS w/ internal pull-down	VOD[1:0] adjusts the output differential amplitude voltage level on all outputs. 00 set output VOD = 600 mVp-p (Default) 01 sets output VOD = 800 mVp-p 10 sets output VOD = 1000 mVp-p 11 sets output VOD = 1200 mVp-p Note: VOD should be set to a minimum of 1000 mV to achieve stated DE levels.
Analog			
SD_TH	27	I, ANALOG	Threshold select pin for electrical idle detect threshold. Float pin for default 130 mVp-p (differential). See Table 4
Power			
VDD	9, 14, 36, 41, 51	Power	2.5V Power supply pins.
GND	DAP, 52	Power	DAP is the large metal contact at the bottom side, located at the center of the 54 pin LLP package. It should be connected to the GND plane with at least 4 via to lower the ground impedance and improve the thermal performance of the package. NOTE: DAP is the primary GND
NC	1, 2, 5, 6, 12, 13, 17, 18		No Connect — Leave pin open

1 = HIGH, 0 = LOW, FLOAT = 3rd input state.

FLOAT condition; Do not drive pin; pin is internally biased to mid level with 50 kΩ pull-up/pull-down.

Internal pulled-down = Internal 30 kΩ pull-down resistor to GND is present on the input.

Input edge rate for LVCMOS/FLOAT inputs must be faster than 50 ns from 10–90%.

Absolute Maximum Ratings *(Note 1)*

If Military/Aerospace specified devices are required, please contact the National Semiconductor Sales Office/Distributors for availability and specifications.

Supply Voltage (VDD)	-0.5V to +3.0V
LVC MOS Input/Output Voltage	-0.5V to +4.0V
Differential Input Voltage	-0.5V to (VDD+0.5V)
Differential Output Voltage	-0.5V to (VDD+0.5V)
Analog (SD_TH)	-0.5V to (VDD+0.5V)
Junction Temperature	+105°C
Storage Temperature	-40°C to +125°C

Maximum Package Power Dissipation at 25°C	
SQA54A Package	4.21 W
Derate SQA54A Package	52.6mW/°C above +25°C

ESD Rating	
HBM, STD - JESD22-A114C	≥6 kV

MM, STD - JESD22-A115-A	≥250 V
CDM, STD - JESD22-C101-C	≥1250 V
Thermal Resistance	
θ_{JC}	11.5°C/W
θ_{JA} , No Airflow, 4 layer JEDEC	19.1°C/W

Recommended Operating Conditions

	Min	Typ	Max	Units
Supply Voltage				
VDD to GND		2.5		V
Ambient Temperature	-40	25	+85	°C
(<i>Note 4</i>)				
SMBus (SDA, SCL)	0		3.6	V
CML Differential Input Voltage	0		2.0	Vp-p
Supply Noise Tolerance up to 50 MHz, (<i>Note 5</i>)		100		mV _{P-P}

Electrical Characteristics

Over recommended operating supply and temperature ranges with default register settings unless other specified. (*Note 3*)

Symbol	Parameter	Conditions	Min	Typ	Max	Units
POWER						
PD	Power Dissipation 2.5V Operation	EQx = 0, DEMx = 0 dB, K28.5 pattern, VOD = 1.0 V p-p		850	950	mW
		Channel powerdown (<i>Note 7</i>)			11	mW
LVC MOS / LVTTL DC SPECIFICATIONS						
V _{IH}	High Level Input Voltage		2.0		3.6	V
V _{IL}	Low Level Input Voltage		0		0.8	V
I _{IH}	Input High Current	V _{IN} = 3.3V	-15		+15	μA
I _{IL}	Input Low Current	V _{IN} = 0V	-15		+15	μA
CML RECEIVER INPUTS (IN_{n+}, IN_{n-})						
RL _{RX-DIFF}	Rx Differential Return Loss (SDD11), (<i>Note 2</i>)	150 MHz – 1.5 GHz		-20		dB
		150 MHz – 3.0 GHz		-13.5		
		150 MHz – 6.0 GHz		-8		
RL _{RX-CM}	Rx Common Mode Input Return Loss (SCC11)	150 MHz – 3.0 GHz, (<i>Note 2</i>)		-10		dB
R _{RX-IB}	Rx Impedance Balance (SDC11)	150 MHz – 3.0 GHz, (<i>Note 2</i>)		-27		dB
I _{IN}	Maximum current allowed at IN+ or IN- input pin.		-30		+30	mA
R _{IN}	Input Resistance	Single ended to V _{DD} , (<i>Note 2</i>)		50		Ω
R _{ITD}	Input Differential Impedance between IN+ and IN-	(<i>Note 2</i>)	85	100	115	Ω
R _{ITIB}	Input Differential Impedance Imbalance	(<i>Note 2</i>)			5	Ω
R _{ICM}	Input Common Mode Impedance	(<i>Note 2</i>)	20	25	40	Ω
V _{RX-DIFF}	Differential Rx peak to peak voltage	DC voltage, SD_TH = 20 kΩ to GND	0.1		1.2	V
V _{RX-SD_TH}	Electrical Idle detect threshold (differential)	SD_TH = Float, (<i>Note 8</i>), <i>Figure 5</i>	40		175	mV _{P-P}

Symbol	Parameter	Conditions	Min	Typ	Max	Units
DIFFERENTIAL OUTPUTS (OUT_{n+}, OUT_{n-})						
V _{OD}	Output Differential Voltage Swing with de-emphasis disabled	R _L = 50 Ω ±1% to GND (AC coupled with 10 nF), 6.4 Gbps, (Note 6) DEMA = DEMB = 0 dB, VOD1-0 = 00	500	600	700	mV _{P-P}
		VOD1-0 = 11	1100	1265	1450	mV _{P-P}
V _{OCM}	Output Common-Mode Voltage	Single-ended measurement DC-Coupled with 50Ω termination, (Note 2)		V _{DD} - 1.4		V
T _{TX-RF}	Transmitter Rise/ Fall Time	20% to 80% of differential output voltage, measured within 1" from output pins, (Note 2, Note 6), Figure 1		65	85	ps
T _{RF-DELTA}	Tx rise/fall mismatch	20% to 80% of differential output voltage, (Note 2, Note 6)			0.1	UI
RL _{TX-DIFF}	Tx Differential Return Loss (SDD22), (Note 2)	Repeating 1100b (D24.3) pattern, VOD = 1.0 Vp-p, 150 MHz – 1.5 GHz		-11		dB
		1.5 GHz – 3.0 GHz		-10		
		3 GHz – 6.0 GHz		-5		
RL _{TX-CM}	Tx Common Mode Return Loss (SCC22)	Repeating 1100b (D24.3) pattern, VOD = 1.0 Vp-p, (Note 2) 50 MHz – 3.0 GHz		-10		dB
R _{TX-IB}	Tx Impedance Balance (SDC22)	Repeating 1100b (D24.3) pattern, VOD = 1.0 Vp-p, (Note 2) 50 MHz – 3.0 GHz		-30		dB
I _{TX-SHORT}	Tx Output Short Circuit Current Limit				90	mA
R _{OTD}	Output Differential Impedance between OUT+ and OUT-	(Note 2)	85	100	125	Ω
R _{OTIB}	Output Differential Impedance Imbalance	(Note 2)			5	Ω
R _{OCM}	Output Common Mode Impedance	(Note 2)	20	25	35	Ω
V _{TX-CM-DELTA}	Common Mode Voltage Delta between active burst and electrical Idle of an OOB signal	Minimum Temperature for OOB signal pass-through is -10C. VIN = 800 mVp-p, at 3 Gbps, (Note 9)			±40	mV
T _{DI}	Max time to transition to valid electrical idle after leaving active burst in OOB signaling	Minimum Temperature for OOB signal pass-through is -10C. VIN = 800 mVp-p, at 3 Gbps, Figure 3		6.5	9.5	ns
T _{ID}	Max time to transition to valid active burst after leaving idle in OOB signaling	Minimum Temperature for OOB signal pass-through is -10C. VIN = 800 mVp-p, at 3 Gbps, Figure 3		5.5	8.0	ns
T _{PD}	Differential Propagation Delay (Low to High and High to Low Edge)	Propagation delay measure at midpoint crossing between input to output EQx[1:0] = 11, DEMx[1:0] = -6 dB Figure 2	150	200	250	ps
		EQz[1:0] = OFF, DEMx[1:0] = 0 dB	120	170	220	ps
T _{LSK}	Lane to Lane Skew in a Single Part	V _{DD} = 2.5V, T _A = 25C			27	ps
T _{PPSK}	Part to Part Propagation Delay Skew	V _{DD} = 2.5V, T _A = 25C			35	ps
T _{SM}	Switch/Mux Time	Time to switch/mux between A and B input/output signals			150	ns

Symbol	Parameter	Conditions	Min	Typ	Max	Units
EQUALIZATION						
DJ1	Residual Deterministic Jitter at 6.4 Gbps	Tx Launch Amplitude = 0.8 to 1.2 V _{p-p} , 40" 4-mil FR4 trace, ENSMB = 1, EQ setting = 0x3B, DEMx[1:0] = 0dB, VOD = 1.0 V _{p-p} , K28.5, SD_TH = float <i>(Note 2)</i>		0.12	0.25	UI _{p-p}
DJ2	Residual Deterministic Jitter at 3.2 Gbps	Tx Launch Amplitude = 0.8 to 1.2 V _{p-p} , 40" 4-mil FR4 trace, EQ setting = 0x3C, DEMx[1:0] = 0dB, VOD = 1.0 V _{p-p} , K28.5, SD_TH = float <i>(Note 2)</i>		0.05	0.125	UI _{p-p}
RJ	Random Jitter	Tx Launch Amplitude = 0.8 to 1.2 V _{p-p} , Repeating 1100b (D24.3) pattern		0.5		psrms
DE-EMPHASIS						
DJ3	Residual Deterministic Jitter at 6.4 Gbps	Tx Launch Amplitude = 0.8 to 1.2 V _{p-p} , 10" 4-mil FR4 trace, EQx = off, DEMx = -6 dB, VOD = 1.0 V _{p-p} , K28.5, RATE = 1 <i>(Note 2)</i>		0.09	0.20	UI _{p-p}
DJ4	Residual Deterministic Jitter at 3.2 Gbps	Tx Launch Amplitude = 0.8 to 1.2 V _{p-p} , 20" 4-mil FR4 trace, EQx = off, DEMx = -6 dB, VOD = 1.0 V _{p-p} , K28.5, RATE = 0 <i>(Note 2)</i>		0.07	0.18	UI _{p-p}

Note 1: "Absolute Maximum Ratings" indicate limits beyond which damage to the device may occur, including inoperability and degradation of device reliability and/or performance. Functional operation of the device and/or non-degradation at the Absolute Maximum Ratings or other conditions beyond those indicated in the Recommended Operating Conditions is not implied. The Recommended Operating Conditions indicate conditions at which the device is functional and the device should not be operated beyond such conditions. Absolute Maximum Numbers are guaranteed for a junction temperature range of -40°C to +125°C. Models are validated to Maximum Operating Voltages only.

Note 2: Typical values represent most likely parametric norms at V_{DD} = 2.5V, T_A = 25°C., and at the Recommended Operation Conditions at the time of product characterization and are not guaranteed.

Note 3: The Electrical Characteristics tables list guaranteed specifications under the listed Recommended Operating Conditions except as otherwise modified or specified by the Electrical Characteristics Conditions and/or Notes. Typical specifications are estimations only and are not guaranteed.

Note 4: OOB signal pass-through limited to a minimum ambient temperature of -10C

Note 5: Allowed supply noise (mV_{p-p} sine wave) under typical conditions.

Note 6: Measured with clock-like {11111 00000} pattern.

Note 7: Measured with ENSMB = 1, all channels disabled using SMBus registers 0x01 and 0x02, and EQ in bypass (Default)

Note 8: Measured at package pins of receiver. Less than 65 mV_{p-p} is IDLE, greater than 175 mV_{p-p} is ACTIVE. SD_TH pin connected with resistor to GND overrides this default setting.

Note 9: Common-mode voltage (VCM) is expressed mathematically as the average of the two signal voltages with respect to local ground.

VCM = (A + B) / 2, A = OUT+, B = OUT-.

Electrical Characteristics — Serial Management Bus Interface

Over recommended operating supply and temperature ranges unless other specified.

Symbol	Parameter	Conditions	Min	Typ	Max	Units
SERIAL BUS INTERFACE DC SPECIFICATIONS						
V_{IL}	Data, Clock Input Low Voltage				0.8	V
V_{IH}	Data, Clock Input High Voltage		2.1		3.6	V
I_{PULLUP}	Current Through Pull-Up Resistor or Current Source	High Power Specification	4			mA
V_{DD}	Nominal Bus Voltage		2.375		3.6	V
$I_{LEAK-BUS}$	Input Leakage Per Bus Segment	(Note 10)	-200		+200	μ A
$I_{LEAK-Pin}$	Input Leakage Per Device Pin			-15		μ A
C_I	Capacitance for SDA and SDC	(Note 10, Note 11)			10	pF
R_{TERM}	External Termination Resistance pull to $V_{DD} = 2.5V \pm 5\%$ OR $3.3V \pm 10\%$	$V_{DD3.3}$ (Note 10, Note 11, Note 12)		2000		Ω
		$V_{DD2.5}$ (Note 10, Note 11, Note 12)		1000		Ω
SERIAL BUS INTERFACE TIMING SPECIFICATIONS. See Figure 4						
FSMB	Bus Operating Frequency	(Note 13)	10		100	kHz
TBUF	Bus Free Time Between Stop and Start Condition		4.7			μ s
THD:STA	Hold time after (Repeated) Start Condition. After this period, the first clock is generated.	At I_{PULLUP} , Max	4.0			μ s
TSU:STA	Repeated Start Condition Setup Time		4.7			μ s
TSU:STO	Stop Condition Setup Time		4.0			μ s
THD:DAT	Data Hold Time		300			ns
TSU:DAT	Data Setup Time		250			ns
$T_{TIMEOUT}$	Detect Clock Low Timeout	(Note 13)	25		35	ms
T_{LOW}	Clock Low Period		4.7			μ s
T_{HIGH}	Clock High Period	(Note 13)	4.0		50	μ s
$T_{LOW:SEXT}$	Cumulative Clock Low Extend Time (Slave Device)	(Note 13)			2	ms
t_F	Clock/Data Fall Time	(Note 13)			300	ns
t_R	Clock/Data Rise Time	(Note 13)			1000	ns
t_{POR}	Time in which a device must be operational after power-on reset	(Note 13)			500	ms

Note 10: Recommended value. Parameter not tested in production.

Note 11: Recommended maximum capacitance load per bus segment is 400pF.

Note 12: Maximum termination voltage should be identical to the device supply voltage.

Note 13: Compliant to SMBus 2.0 physical layer specification. See System Management Bus (SMBus) Specification Version 2.0, section 3.1.1 SMBus common AC specifications for details.

Timing Diagrams

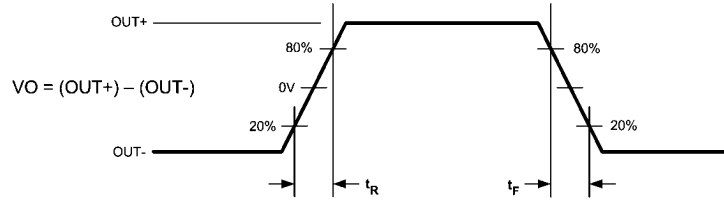

30076452

FIGURE 1. LPDS Output Transition Times

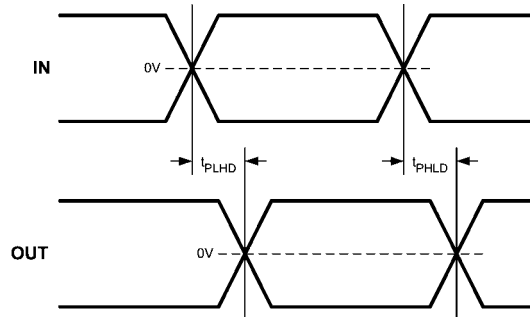

30076453

FIGURE 2. Propagation Delay Timing Diagram

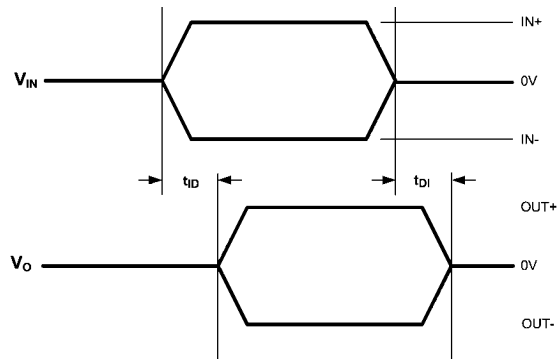

30076454

FIGURE 3. Idle Timing Diagram

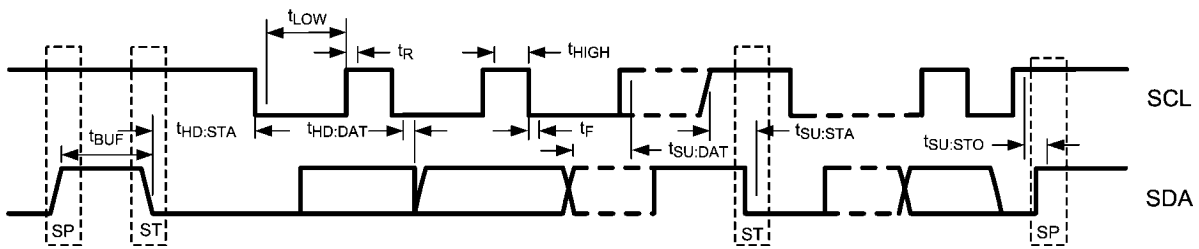

30076494

FIGURE 4. SMBus Timing Parameters

Functional Description

The DS64MB201 is a 2-lane signal conditioning 2:1 multiplexer and 1:2 switch or fan-out buffer optimized for PCB FR4 trace and cable interconnects up to 6 Gbps data rate. The DS64MB201 operates in two modes: Pin Control Mode (ENSMB = 0) and SMBus Mode (ENSMB = 1).

Pin Control Mode:

When in pin mode (ENSMB = 0), the transceiver is configurable with external pins. Equalization and de-emphasis can be selected via pin for each side independently. When de-emphasis is asserted VOD is automatically increased per the De-Emphasis table below for improved performance over lossy media. Rate optimization is also pin controllable, with

pin selections for 3 Gbps, 6 Gbps, and auto detect. The receiver electrical idle detect threshold is also programmable via an optional external resistor on the SD_TH pin.

SMBUS Mode:

When in SMBus mode the VOD amplitude level, equalization and de-emphasis are all programmable on a individual lane basis, instead of grouped by sides as in the pin mode case. Upon assertion of ENSMB pins EQx and DEMx functions revert to register control immediately. The EQx and DEMx pins are converted to AD0-AD3 SMBus address pins. The other external control pins remain active unless their respective registers are written to, in which case they are ignored until ENSMB is driven low. On power-up and when ENSMB is driven low all registers are reset to their default state.

TABLE 1. Equalization Input Select Pins for SIA, SIB and DIN (3-Level Input)

EQA, EQB, EQD	Equalization Level
0	9 dB at 3 GHz
Float (No Connect)	13.5 dB at 3 GHz
1	18.4 dB at 3 GHz

Note: F = Float (No Connect), 1 = High and 0 = Low.

TABLE 2. De-Emphasis Input Select Pins for SOA, SOB and DOUT (3-Level Input)

RATE	DEMA, DEMB, DEMD	De-Emphasis Level (typ)	DE Pulse Width (typ)	VOD (typ)
0/F	0	-3.5 dB	330 ps	VOD = 1000 mVp-p
		-2 dB	330 ps	VOD = 1200 mVp-p
0/F	1	-6 dB	330 ps	VOD = 1000 mVp-p
		-3 dB	330 ps	VOD = 1200 mVp-p
1/F	0	-3.5 dB	200 ps	VOD = 1000 mVp-p
		-2 dB	200 ps	VOD = 1200 mVp-p
1/F	1	-6 dB	200 ps	VOD = 1000 mVp-p
		-3 dB	200 ps	VOD = 1200 mVp-p
0/F	F	-9 dB	250 ps enhanced	VOD = 1200 mVp-p
1/F	F	-12 dB	160 ps enhanced	VOD = 1200 mVp-p

Note: F = Float (No Connect), 1 = High and 0 = Low. Enhanced DE pulse width provides de-emphasis on second bit.

When RATE = F (auto rate detection active), the DE level and pulse width settings follow detected rate. RATE = 0 is 3 Gbps and RATE = 1 is 6 Gbps. De-emphasis should only be used with VOD = 1000 mVp-p or 1200 mVp-p. VOD less than 1000 mVp-p is not recommended with de-emphasis. Please refer to VOD1 and VOD0 pin description to set the output differential voltage level.

TABLE 3. Idle Control (3-Level Input)

TXIDLEDO/SO	Function
0	This state is for lossy media, dedicated Idle threshold detect circuit disabled, output follows input based on EQ settings. Idle state not guaranteed.
Float	Float enables automatic idle detection. Idle on the input is passed to the output. Internal 50K Ω resistors hold TXIDLEDO/SO pin at a mid level - don't connect this pin if the automatic idle detect function is desired. This is the default state. Output in Idle if differential input signal less than value set by SD_TH pin.
1	Manual override, output in electrical Idle. Differential inputs are ignored.

TABLE 4. Receiver Electrical Idle Detect Threshold Adjust

SD_TH resistor value (Ω)	Receiver Electrical Idle Detect Threshold (DIFF p-p)
Float (no resistor required)	130 mV (default condition)
0	225 mV
80k	20 mV

SD_TH resistor value can be set from 0 through 80k ohms to achieve desired idle detect threshold, see [Figure 5](#)

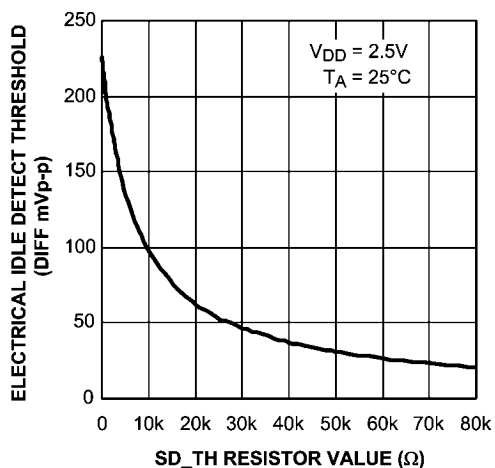

30076493

FIGURE 5. Typical Idle Threshold vs. SD_TH resistor value

Device Connection Paths

The lanes of the DS64MB201 can be configured either as a 2:1 multiplexer, 1:2 switch or fan-out buffer. The controller side is muxed to the disk drive side. The below table shows the logic for the multiplexer and switch functions.

TABLE 5. Logic Table of Switch and Mux Control

FANOUT	SEL0	SEL1	Function — connection path
0	0	0	DOUT0 connects to SIB0. DOUT1 connects to SIB1. DIN0 connects to SOB0. SOA0 is in idle (output muted). DIN1 connects to SOB1. SOA1 is in idle (output muted).
0	0	1	DOUT0 connects to SIB0. DOUT1 connects to SIA1. DIN0 connects to SOB0. SOA0 is in idle (output muted). DIN1 connects to SOA1. SOB1 is in idle (output muted).
0	1	0	DOUT0 connects to SIA0. DOUT1 connects to SIB1. DIN0 connects to SOA0. SOB0 is in idle (output muted). DIN1 connects to SOB1. SOA1 is in idle (output muted).
0	1	1	DOUT0 connects to SIA0. DOUT1 connects to SIA1. DIN0 connects to SOA0. SOB0 is in idle (output muted). DIN1 connects to SOA1. SOB1 is in idle (output muted).
1	0	0	DOUT0 connects to SIB0. DOUT1 connects to SIB1. DIN0 connects to SOB0 and SOA0. DIN1 connects to SOB1 and SOA1.
1	0	1	DOUT0 connects to SIB0. DOUT1 connects to SIA1. DIN0 connects to SOB0 and SOA0. DIN1 connects to SOA1 and SOB1.
1	1	0	DOUT0 connects to SIA0. DOUT1 connects to SIB1. DIN0 connects to SOA0 and SOB0. DIN1 connects to SOB1 and SOA1.
1	1	1	DOUT0 connects to SIA0. DOUT1 connects to SIA1. DIN0 connects to SOA0 and SOB0. DIN1 connects to SOA1 and SOB1.

System Management Bus (SMBus) and Configuration Registers

The System Management Bus interface is compatible to SMBus 2.0 physical layer specification. ENSMB must be pulled high to enable SMBus mode and allow access to the configuration registers.

The DS64MB201 has the AD[3:0] inputs in SMBus mode. These pins set the SMBus slave address inputs. The AD[3:0] pins have internal pull-down. When left floating or pulled low the AD[3:0] = 0000'b, the device default address byte is A0'h. Based on the SMBus 2.0 specification, the DS64MB201 has a 7-bit slave address of 1010000'b. The LSB is set to 0'b (for a WRITE), thus the 8-bit value is 1010 0000'b or A0'h. The bold bits indicate the AD[3:0] pin map to the slave address bits [4:1]. The device address byte can be set with the use of the AD[3:0] inputs. Below are some examples.

AD[3:0] = 0001'b, the device address byte is A2'h

AD[3:0] = 0010'b, the device address byte is A4'h

AD[3:0] = 0100'b, the device address byte is A8'h

AD[3:0] = 1000'b, the device address byte is B0'h

The SDC and SDA pins are 3.3V LVCMOS signaling and include high-Z internal pull up resistors. External low impedance pull up resistors maybe required depending upon SMBus loading and speed. Note, these pins are not 5V tolerant.

TRANSFER OF DATA VIA THE SMBUS

During normal operation the data on SDA must be stable during the time when SDC is High.

There are three unique states for the SMBus:

START: A High-to-Low transition on SDA while SDC is High indicates a message START condition.

STOP: A Low-to-High transition on SDA while SDC is High indicates a message STOP condition.

IDLE: If SDC and SDA are both High for a time exceeding t_{BUF} from the last detected STOP condition or if they are High for a total exceeding the maximum specification for t_{HIGH} then the bus will transfer to the IDLE state.

SMBUS TRANSACTIONS

The device supports WRITE and READ transactions. See Register Description table for register address, type (Read/Write, Read Only), default value and function information.

When SMBus is enabled, all outputs of the DS64MB201 **must use one of the following De-emphasis settings** (Table 6). The driver de-emphasis value is set on a per lane basis using 6 different registers. Each register (0x18, 0x26, 0x2E, 0x35, 0x3C, 0x43) requires one of the following De-emphasis settings when in SMBus mode. The VOD for each output should be set via register write or pin control to be a minimum of 1000 mV.

TABLE 6. De-Emphasis Register Settings (must write one of the following when in SMBus mode)

De-Emphasis Value	Register Setting	3 Gbps Operation	6 Gbps Operation
0.0 dB	0x01	10" trace or 1 meter 28 awg cable	5" trace or 0.5 meter 28 awg cable
-3.5 dB	0xE8	20" trace or 2 meters 28 awg cable	10" trace or 1 meters 28 awg cable
-6 dB	0x88	25" trace or 3 meters cable	20" trace or 2 meters cable
-9 dB	0x90	5 meters 28 awg cable	3 meters 28 awg cable
-12 dB	0xA0	8 meters 28 awg cable	5 meters 28 awg cable

WRITING A REGISTER

To write a register, the following protocol is used (see SMBus 2.0 specification).

1. The Host drives a START condition, the 7-bit SMBus address, and a "0" indicating a WRITE.
2. The Device (Slave) drives the ACK bit ("0").
3. The Host drives the 8-bit Register Address.
4. The Device drives an ACK bit ("0").
5. The Host drive the 8-bit data byte.
6. The Device drives an ACK bit ("0").
7. The Host drives a STOP condition.

The WRITE transaction is completed, the bus goes IDLE and communication with other SMBus devices may now occur.

READING A REGISTER

To read a register, the following protocol is used (see SMBus 2.0 specification).

1. The Host drives a START condition, the 7-bit SMBus address, and a "0" indicating a WRITE.
2. The Device (Slave) drives the ACK bit ("0").
3. The Host drives the 8-bit Register Address.
4. The Device drives an ACK bit ("0").
5. The Host drives a START condition.
6. The Host drives the 7-bit SMBus Address, and a "1" indicating a READ.

7. The Device drives an ACK bit "0".
8. The Device drives the 8-bit data value (register contents).
9. The Host drives a NACK bit "1" indicating end of the READ transfer.
10. The Host drives a STOP condition.

The READ transaction is completed, the bus goes IDLE and communication with other SMBus devices may now occur.

RECOMMENDED SMBUS REGISTER SETTINGS

When SMBus mode is enabled (ENSMB = 1), the default register settings are not configured to an appropriate level. Below is the recommended settings to configure the EQ, VOD and DE to a medium level that supports interconnect length of 20 inches FR4 trace or 3 to 5 meters of cable length. Please refer to Table 1, Table 2, Table 6, Table 7 for additional information and recommended settings.

1. Reset the SMBus registers to default values:
Write 01'h to 0x00.
2. Set de-emphasis to -6 dB for all lanes:
Write 88'h to 0x18, 0x26, 0x2E, 0x35, 0x3C, 0x43.
3. Set equalization to external pin level EQ[1:0] = 00 (~9 dB at 3 GHz) for all lanes:
Write 30'h to 0x0F, 0x16, 0x1D, 0x24, 0x2C, 0x3A.
4. Set VOD = 1.0 Vp-p for all lanes:
Write 0F'h to 0x17, 0x25, 0x2D, 0x34, 0x3B, 0x42.

TABLE 7. SMBus Register Map

Address	Register Name	Bit (s)	Field	Type	Default	Description
0x00	Reset	7:1	Reserved	R/W	0x00	Set bits to 0.
		0	Reset			SMBus Reset 1: Reset registers to default value
0x01	PWDN lanes	7:0	PWDN CHx	R/W	0x00	Power Down per lane [7]: NC — SOB1 [6]: DIN1 — SOA1 [5]: NC — SOB0 [4]: DIN0 — SOA0 [3]: SIB1 — DOUT1 [2]: SIA1 — NC [1]: SIB0 — DOUT0 [0]: SIA0 — NC 00'h = all lanes enabled FF'h = all lanes disabled
0x02	PWDN Control	7:1	Reserved	R/W	0x00	Set bits to 0.
		0	PWDN Control			0: Normal operation 1: Enable PWDN control in Register 0x01
0x03	SEL / FANOUT Control	7:3	Reserved	R/W	0x00	Set bits to 0.
		2	SEL1			0: Selects SIB1 input and SOB1 output 1: Selects SIA1 input and SOA1 output
		1	SEL0			0: Selects SIB0 input and SOB0 output 1: Selects SIA0 input and SOA0 output
		0	FANOUT			0: Enable only A or B output depends on SEL1 and SEL0 (See Mux Control Truth Table) 1: Enable both SOAn and SOBn output
0x08	Pin Control Override	7:5	Reserved	R/W	0x00	Set bits to 0.
		4	Override IDLE			0: Allow IDLE pin control 1: Block IDLE pin control
		3	Reserved			Set bit to 0.
		2	Override RATE			0: Allow RATE pin control 1: Block RATE pin control
		1	Override SEL			0: Allow SEL pin control 1: Block SEL pin control
		0	Override FANOUT			0: Allow FANOUT pin control 1: Block FANOUT pin control

0x0F	SIA0 EQ Control	7:6	Reserved	R/W	0x20	Set bits to 0.
		5:0	SIA0 EQ			SIA0 EQ Control - total of 24 levels (3 gain stages with 8 settings) [5]: Enable EQ [4:3]: Gain Stage Control [2:0]: Boost Level Control Register [EN] [GST] [BST] = Hex Value 100000 = 20'h = Bypass (Default) 101010 = 2A'h = 5 dB at 3 GHz 110000 = 30'h = 9 dB at 3 GHz 110010 = 32'h = 11.7 dB at 3 GHz 111001 = 39'h = 14.6 dB at 3 GHz 110101 = 35'h = 18.4 dB at 3 GHz 110111 = 37'h = 20 dB at 3 GHz 111011 = 3B'h = 21.2 dB at 3 GHz 111101 = 3D'h = 28.4 dB at 3 GHz
0x12	SIA0 IDLE Threshold	7:4	Reserved	R/W	0x00	Set bits to 0.
		3:0	IDLE threshold			De-assert = [3:2], assert = [1:0] 00 = 110 mV, 70 mV (Default) 01 = 150 mV, 110 mV 10 = 170 mV, 130 mV 11 = 190 mV, 150 mV
0x15	DOUT0 IDLE RATE Select	7:6	Reserved	R/W	0x00	Set bits to 0.
		5	IDLE auto			0: Allow IDLE_sel control in Bit 4 1: Automatic IDLE detect
		4	IDLE select			0: Output is ON (SD is disabled) 1: Output is muted (electrical idle)
		3:2	Reserved			Set bits to 0.
		1	RATE auto			0: Allow RATE_sel control in Bit 0 1: Automatic RATE detect
		0	RATE select			0: 2.5 to 3.2 Gbps 1: 5.0 to 6.4 Gbps
0x16	SIB0 EQ Control	7:6	Reserved	R/W	0x20	Set bits to 0.
		5:0	SIB0 EQ			SIB0 Control - total of 24 levels (3 gain stages with 8 settings) [5]: Enable EQ [4:3]: Gain Stage Control [2:0]: Boost Level Control Register [EN] [GST] [BST] = Hex Value 100000 = 20'h = Bypass (Default) 101010 = 2A'h = 5 dB at 3 GHz 110000 = 30'h = 9 dB at 3 GHz 110010 = 32'h = 11.7 dB at 3 GHz 111001 = 39'h = 14.6 dB at 3 GHz 110101 = 35'h = 18.4 dB at 3 GHz 110111 = 37'h = 20 dB at 3 GHz 111011 = 3B'h = 21.2 dB at 3 GHz 111101 = 3D'h = 28.4 dB at 3 GHz
0x17	DOUT0 VOD Control	7	Reserved	R/W	0x03	Set bit to 0.
		6:0	DOUT0 VOD			DOUT0 VOD Control 03'h = 600 mV (Default) 07'h = 800 mV 0F'h = 1000 mV 1F'h = 1200 mV 3F'h = Reserved

0x18	DOUT0 DE Control	7:0	DOUT0 DEM	R/W	0x03	DOUT0 DEM Control [7]: DEM TYPE (Compatibility = 0 / Enhanced = 1) [6:0]: DEM Level Control Register [TYPE] [Level Control] = Hex Value 00000001 = 01'h = 0.0 dB 00111000 = E8'h = -3.5 dB 10001000 = 88'h = -6.0 dB 10010000 = 90'h = -9.0 dB 10100000 = A0'h = -12.0 dB
0x19	SIB0 IDLE Threshold	7:4	Reserved	R/W	0x00	Set bits to 0.
		3:0	IDLE threshold			De-assert = [3:2], assert = [1:0] 00 = 110 mV, 70 mV (Default) 01 = 150 mV, 110 mV 10 = 170 mV, 130 mV 11 = 190 mV, 150 mV
0x1D	SIA1 EQ Control	7:6	Reserved	R/W	0x20	Set bits to 0.
		5:0	SIA1 EQ			SIA1 EQ Control - total of 24 levels (3 gain stages with 8 settings) [5]: Enable EQ [4:3]: Gain Stage Control [2:0]: Boost Level Control Register [EN] [GST] [BST] = Hex Value 100000 = 20'h = Bypass (Default) 101010 = 2A'h = 5 dB at 3 GHz 110000 = 30'h = 9 dB at 3 GHz 110010 = 32'h = 11.7 dB at 3 GHz 111001 = 39'h = 14.6 dB at 3 GHz 110101 = 35'h = 18.4 dB at 3 GHz 110111 = 37'h = 20 dB at 3 GHz 111011 = 3B'h = 21.2 dB at 3 GHz 111101 = 3D'h = 28.4 dB at 3 GHz
0x20	SIA1 IDLE Threshold	7:4	Reserved	R/W	0x00	Set bits to 0.
		3:0	IDLE threshold			De-assert = [3:2], assert = [1:0] 00 = 110 mV, 70 mV (Default) 01 = 150 mV, 110 mV 10 = 170 mV, 130 mV 11 = 190 mV, 150 mV
0x23	DOUT1 IDLE RATE Select	7:6	Reserved	R/W	0x00	Set bits to 0.
		5	IDLE auto			0: Allow IDLE_sel control in Bit 4 1: Automatic IDLE detect
		4	IDLE select			0: Output is ON (SD is disabled) 1: Output is muted (electrical idle)
		3:2	Reserved			Set bits to 0.
		1	RATE auto			0: Allow RATE_sel control in Bit 0 1: Automatic RATE detect
		0	RATE select			0: 2.5 to 3.2 Gbps 1: 5.0 to 6.4 Gbps

0x24	SIB1 EQ Control	7:6	Reserved	R/W	0x20	Set bits to 0.
		5:0	SIB1 EQ			SIB1 EQ Control - total of 24 levels (3 gain stages with 8 settings) [5]: Enable EQ [4:3]: Gain Stage Control [2:0]: Boost Level Control Register [EN] [GST] [BST] = Hex Value 100000 = 20'h = Bypass (Default) 101010 = 2A'h = 5 dB at 3 GHz 110000 = 30'h = 9 dB at 3 GHz 110010 = 32'h = 11.7 dB at 3 GHz 111001 = 39'h = 14.6 dB at 3 GHz 110101 = 35'h = 18.4 dB at 3 GHz 110111 = 37'h = 20 dB at 3 GHz 111011 = 3B'h = 21.2 dB at 3 GHz 111101 = 3D'h = 28.4 dB at 3 GHz
0x25	DOUT1 VOD Control	7	Reserved	R/W	0x03	Set bit to 0.
		6:0	DOUT1 VOD			DOUT1 VOD Control 03'h = 600 mV (Default) 07'h = 800 mV 0F'h = 1000 mV 1F'h = 1200 mV 3F'h = Reserved
0x26	DOUT1 DE Control	7:0	DOUT1 DEM	R/W	0x03	DOUT1 DEM Control [7]: DEM TYPE (Compatibility = 0 / Enhanced = 1) [6:0]: DEM Level Control Register [TYPE] [Level Control] = Hex Value 00000001 = 01'h = 0.0 dB 00111000 = E8'h = -3.5 dB 10001000 = 88'h = -6.0 dB 10010000 = 90'h = -9.0 dB 10100000 = A0'h = -12.0 dB
0x27	SIB1 IDLE Threshold	7:4	Reserved	R/W	0x00	Set bits to 0.
		3:0	IDLE threshold			De-assert = [3:2], assert = [1:0] 00 = 110 mV, 70 mV (Default) 01 = 150 mV, 110 mV 10 = 170 mV, 130 mV 11 = 190 mV, 150 mV
0x2B	SOA0 IDLE RATE Select	7:6	Reserved	R/W	0x00	Set bits to 0.
		5	IDLE auto			0: Allow IDLE_sel control in Bit 4 1: Automatic IDLE detect
		4	IDLE select			0: Output is ON (SD is disabled) 1: Output is muted (electrical idle)
		3:2	Reserved			Set bits to 0.
		1	RATE auto			0: Allow RATE_sel control in Bit 0 1: Automatic RATE detect
		0	RATE select			0: 2.5 to 3.2 Gbps 1: 5.0 to 6.4 Gbps

0x2C	DIN0 EQ Control	7:6	Reserved	R/W	0x20	Set bits to 0.
		5:0	DIN0 EQ			DIN0 EQ Control - total of 24 levels (3 gain stages with 8 settings) [5]: Enable EQ [4:3]: Gain Stage Control [2:0]: Boost Level Control Register [EN] [GST] [BST] = Hex Value 100000 = 20'h = Bypass (Default) 101010 = 2A'h = 5 dB at 3 GHz 110000 = 30'h = 9 dB at 3 GHz 110010 = 32'h = 11.7 dB at 3 GHz 111001 = 39'h = 14.6 dB at 3 GHz 110101 = 35'h = 18.4 dB at 3 GHz 110111 = 37'h = 20 dB at 3 GHz 111011 = 3B'h = 21.2 dB at 3 GHz 111101 = 3D'h = 28.4 dB at 3 GHz
0x2D	SOA0 VOD Control	7	Reserved	R/W	0x03	Set bit to 0.
		6:0	SOA0 VOD			SOA0 VOD Control 03'h = 600 mV (Default) 07'h = 800 mV 0F'h = 1000 mV 1F'h = 1200 mV 3F'h = Reserved
0x2E	SOA0 DE Control	7:0	SOA0 DEM	R/W	0x03	SOA0 DEM Control [7]: DEM TYPE (Compatibility = 0 / Enhanced = 1) [6:0]: DEM Level Control Register [TYPE] [Level Control] = Hex Value 00000001 = 01'h = 0.0 dB 00111000 = E8'h = -3.5 dB 10001000 = 88'h = -6.0 dB 10010000 = 90'h = -9.0 dB 10100000 = A0'h = -12.0 dB
0x2F	DIN0 IDLE Threshold	7:4	Reserved	R/W	0x00	Set bits to 0.
		3:0	IDLE threshold			De-assert = [3:2], assert = [1:0] 00 = 110 mV, 70 mV (Default) 01 = 150 mV, 110 mV 10 = 170 mV, 130 mV 11 = 190 mV, 150 mV
0x32	SOB0 IDLE RATE Select	7:6	Reserved	R/W	0x00	Set bits to 0.
		5	IDLE auto			0: Allow IDLE_sel control in Bit 4 1: Automatic IDLE detect
		4	IDLE select			0: Output is ON (SD is disabled) 1: Output is muted (electrical idle)
		3:2	Reserved			Set bits to 0.
		1	RATE auto			0: Allow RATE_sel control in Bit 0 1: Automatic RATE detect
		0	RATE select			0: 2.5 to 3.2 Gbps 1: 5.0 to 6.4 Gbps
0x34	SOB0 VOD Control	7	Reserved	R/W	0x03	Set bit to 0.
		6:0	SOB0 VOD			SOB0 VOD Control 03'h = 600 mV (Default) 07'h = 800 mV 0F'h = 1000 mV 1F'h = 1200 mV 3F'h = Reserved

0x35	SOB0 DE Control	7:0	SOB0 DEM	R/W	0x03	SOB0 DEM Control [7]: DEM TYPE (Compatibility = 0 / Enhanced = 1) [6:0]: DEM Level Control Register [TYPE] [Level Control] = Hex Value 00000001 = 01'h = 0.0 dB 00111000 = E8'h = -3.5 dB 10001000 = 88'h = -6.0 dB 10010000 = 90'h = -9.0 dB 10100000 = A0'h = -12.0 dB
0x39	SOA1 IDLE RATE Select	7:6	Reserve	R/W	0x00	Set bits to 0.
		5	IDLE auto			0: Allow IDLE_sel control in Bit 4 1: Automatic IDLE detect
		4	IDLE select			0: Output is ON (SD is disabled) 1: Output is muted (electrical idle)
		3:2	Reserved			Set bits to 0.
		1	RATE auto			0: Allow RATE_sel control in Bit 0 1: Automatic RATE detect
		0	RATE select			0: 2.5 to 3.2 Gbps 1: 5.0 to 6.4 Gbps
0x3A	DIN1 EQ Control	7:6	Reserved	R/W	0x20	Set bits to 0.
		5:0	DIN1 EQ			DIN1 EQ Control - total of 24 levels (3 gain stages with 8 settings) [5]: Enable EQ [4:3]: Gain Stage Control [2:0]: Boost Level Control Register [EN] [GST] [BST] = Hex Value 100000 = 20'h = Bypass (Default) 101010 = 2A'h = 5 dB at 3 GHz 110000 = 30'h = 9 dB at 3 GHz 110010 = 32'h = 11.7 dB at 3 GHz 111001 = 39'h = 14.6 dB at 3 GHz 110101 = 35'h = 18.4 dB at 3 GHz 110111 = 37'h = 20 dB at 3 GHz 111011 = 3B'h = 21.2 dB at 3 GHz 111101 = 3D'h = 28.4 dB at 3 GHz
0x3B	SOA1 VOD Control	7	Reserved	R/W	0x03	Set bit to 0.
		6:0	SOA1 VOD			SOA1 VOD Control 03'h = 600 mV (Default) 07'h = 800 mV 0F'h = 1000 mV 1F'h = 1200 mV 3F'h = Reserved
0x3C	SOA1 DE Control	7:0	SOA1 DEM	R/W	0x03	SOA1 DEM Control [7]: DEM TYPE (Compatibility = 0 / Enhanced = 1) [6:0]: DEM Level Control Register [TYPE] [Level Control] = Hex Value 00000001 = 01'h = 0.0 dB 00111000 = E8'h = -3.5 dB 10001000 = 88'h = -6.0 dB 10010000 = 90'h = -9.0 dB 10100000 = A0'h = -12.0 dB
0x3D	DIN1 IDLE Threshold	7:4	Reserved	R/W	0x00	Set bits to 0.
		3:0	IDLE threshold			De-assert = [3:2], assert = [1:0] 00 = 110 mV, 70 mV (Default) 01 = 150 mV, 110 mV 10 = 170 mV, 130 mV 11 = 190 mV, 150 mV

0x40	SOB1 IDLE RATE Select	7:6	Reserved	R/W	0x00	Set bits to 0.
		5	IDLE auto			0: Allow IDLE_sel control in Bit 4 1: Automatic IDLE detect
		4	IDLE select			0: Output is ON (SD is disabled) 1: Output is muted (electrical idle)
		3:2	Reserved			Set bits to 0.
		1	RATE auto			0: Allow RATE_sel control in Bit 0 1: Automatic RATE detect
0	RATE select	0: 2.5 to 3.2 Gbps 1: 5.0 to 6.4 Gbps				
0x42	SOB1 VOD Control	7	Reserved	R/W	0x03	Set bit to 0.
		6:0	SOB1 VOD			SOB1 VOD Control 03'h = 600 mV (Default) 07'h = 800 mV 0F'h = 1000 mV 1F'h = 1200 mV 3F'h = Reserved
0x43	SOB1 DE Control	7:0	SOB1 DEM	R/W	0x03	SOB1 DEM Control [7]: DEM TYPE (Compatibility = 0 / Enhanced = 1) [6:0]: DEM Level Control Register [TYPE] [Level Control] = Hex Value 00000001 = 01'h = 0.0 dB 00111000 = E8'h = -3.5 dB 10001000 = 88'h = -6.0 dB 10010000 = 90'h = -9.0 dB 10100000 = A0'h = -12.0 dB
0x47	Global VOD Adjust	7:2	Reserved	R/W	0x02	Set bits to 0.
		1:0	VOD Adjust			00 = -25.0% 01 = -12.5% 10 = +0.0% (Default) 11 = +12.5%

Typical Performance

Unless otherwise noted, Typical Performance is measured at room temperature and nominal supply voltage.

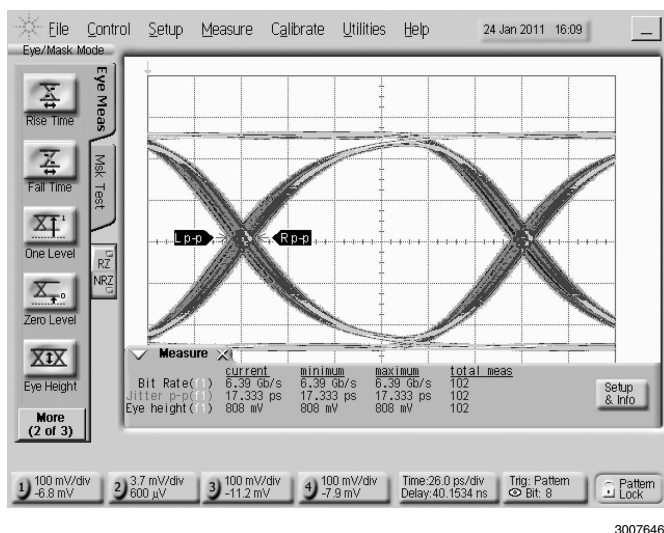

30076460

FIGURE 6. Electrical Specification DJ1: 40" 4-mil microstrip trace on Input

Datarate: 6.4 Gbps

Input Pattern: K28.5

Signal Conditioning: EQ Setting = 3B'h

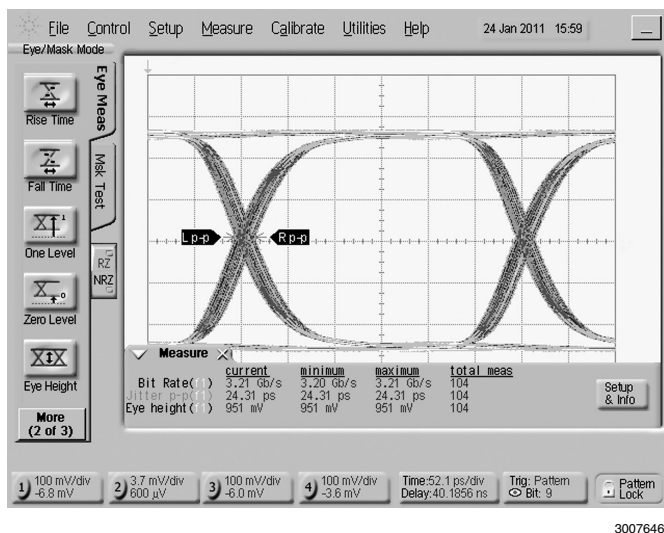

30076461

FIGURE 7. Electrical Specification DJ2: 40" 4-mil microstrip trace on Input

Datarate: 3.2 Gbps

Input Pattern: K28.5

Signal Conditioning: EQ Setting = 3C'h

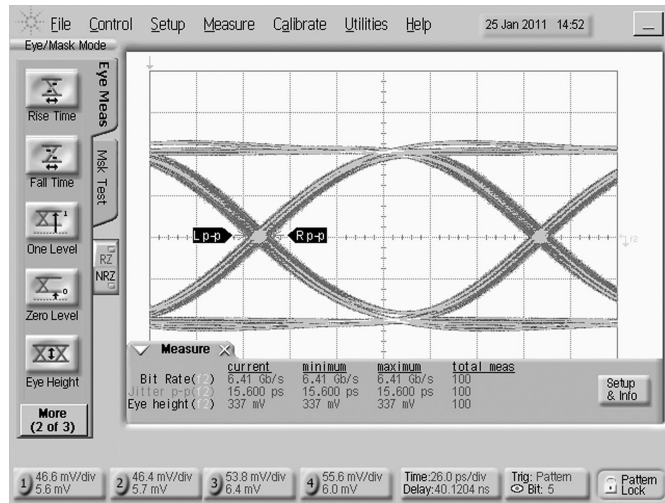

30076462

FIGURE 8. Electrical Specification DJ3: 10" 4-mil microstrip trace on Output

Datarate: 6.4 Gbps

Input Pattern: K28.5

Signal Conditioning: EQ Setting = 20'h (Bypass) and DE Setting = 88'h

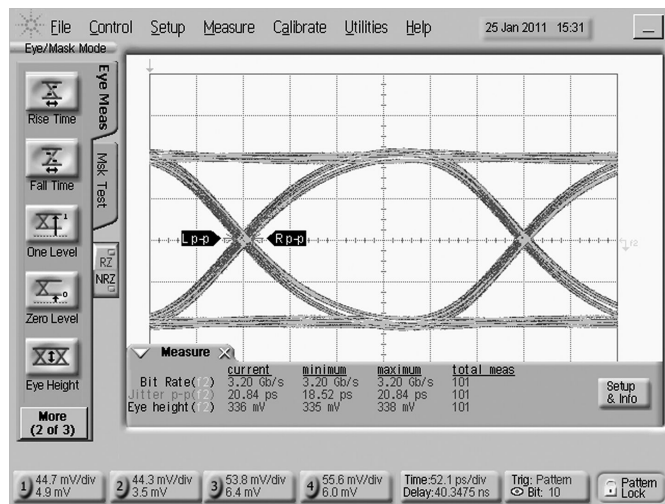

30076463

FIGURE 9. Electrical Specification DJ4: 20" 4-mil microstrip trace on Output

Datarate: 3.2 Gbps

Input Pattern: K28.5

Signal Conditioning: EQ Setting = 20'h (Bypass) and DE Setting = 88'h

Applications Information

GENERAL RECOMMENDATIONS

The DS64MB201 is a high performance circuit capable of delivering excellent performance. Careful attention must be paid to the details associated with high-speed design as well as providing a clean power supply. Refer to the LVDS Owner's Manual for more detailed information on high speed design tips to address signal integrity design issues.

PCB LAYOUT CONSIDERATIONS FOR DIFFERENTIAL PAIRS

The CML inputs and LPDS outputs must have a controlled differential impedance of 100Ω . It is preferable to route differential lines exclusively on one layer of the board, particularly for the input traces. The use of vias should be avoided if possible. If vias must be used, they should be used sparingly and must be placed symmetrically for each side of a given differential pair. Route the differential signals away from other signals and noise sources on the printed circuit board. See AN-1187 for additional information on LLP packages.

POWER SUPPLY BYPASSING

Two approaches are recommended to ensure that the DS64MB201 is provided with an adequate power supply. First, the supply (VDD) and ground (GND) pins should be connected to power planes routed on adjacent layers of the printed circuit board. The layer thickness of the dielectric should be minimized so that the V_{DD} and GND planes create a low inductance supply with distributed capacitance. Second, careful attention to supply bypassing through the proper use of bypass capacitors is required. A $0.01\ \mu\text{F}$ bypass capacitor should be connected to each V_{DD} pin such that the capacitor is placed as close as possible to the DS64MB201. Smaller body size capacitors can help facilitate proper component placement. Additionally, three capacitors with capacitance in the range of $2.2\ \mu\text{F}$ to $10\ \mu\text{F}$ should be incorporated in the power supply bypassing design as well. These capacitors can be either tantalum or an ultra-low ESR ceramic.

Physical Dimensions inches (millimeters) unless otherwise noted

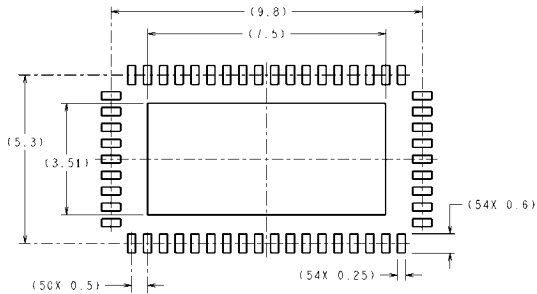

DIMENSIONS ARE IN MILLIMETERS
DIMENSIONS IN () FOR REFERENCE ONLY

RECOMMENDED LAND PATTERN

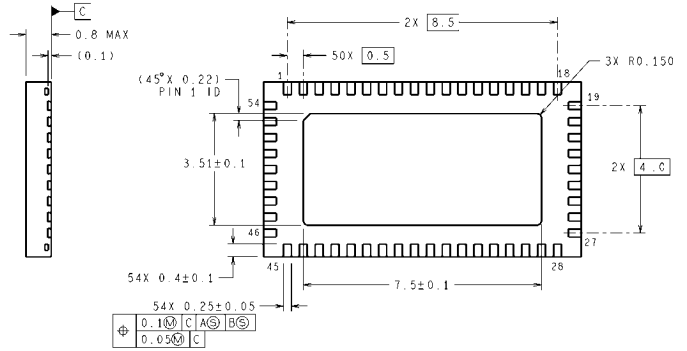
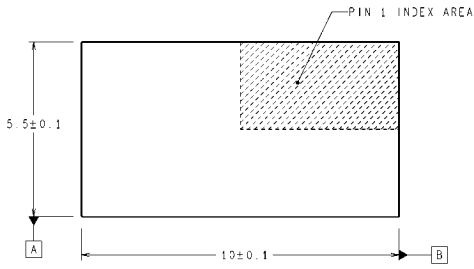

54-pin LLP Package (5.5 mm x 10 mm x 0.8 mm, 0.5 mm pitch)
Order Number: DS64MB201SQ — Tape & Reel Supplied As 2,000 Units,
DS64MB201SQE — Tape & Reel Supplied As 250 Units
Package Number: SQA54A

SQA54A (Rev B)

Notes

Notes

For more National Semiconductor product information and proven design tools, visit the following Web sites at:
www.national.com

Products		Design Support	
Amplifiers	www.national.com/amplifiers	WEBENCH® Tools	www.national.com/webench
Audio	www.national.com/audio	App Notes	www.national.com/appnotes
Clock and Timing	www.national.com/timing	Reference Designs	www.national.com/refdesigns
Data Converters	www.national.com/adc	Samples	www.national.com/samples
Interface	www.national.com/interface	Eval Boards	www.national.com/evalboards
LVDS	www.national.com/lvds	Packaging	www.national.com/packaging
Power Management	www.national.com/power	Green Compliance	www.national.com/quality/green
Switching Regulators	www.national.com/switchers	Distributors	www.national.com/contacts
LDOs	www.national.com/ldo	Quality and Reliability	www.national.com/quality
LED Lighting	www.national.com/led	Feedback/Support	www.national.com/feedback
Voltage References	www.national.com/vref	Design Made Easy	www.national.com/easy
PowerWise® Solutions	www.national.com/powerwise	Applications & Markets	www.national.com/solutions
Serial Digital Interface (SDI)	www.national.com/sdi	Mil/Aero	www.national.com/milaero
Temperature Sensors	www.national.com/tempensors	SolarMagic™	www.national.com/solarmagic
PLL/VCO	www.national.com/wireless	PowerWise® Design University	www.national.com/training

THE CONTENTS OF THIS DOCUMENT ARE PROVIDED IN CONNECTION WITH NATIONAL SEMICONDUCTOR CORPORATION ("NATIONAL") PRODUCTS. NATIONAL MAKES NO REPRESENTATIONS OR WARRANTIES WITH RESPECT TO THE ACCURACY OR COMPLETENESS OF THE CONTENTS OF THIS PUBLICATION AND RESERVES THE RIGHT TO MAKE CHANGES TO SPECIFICATIONS AND PRODUCT DESCRIPTIONS AT ANY TIME WITHOUT NOTICE. NO LICENSE, WHETHER EXPRESS, IMPLIED, ARISING BY ESTOPPEL OR OTHERWISE, TO ANY INTELLECTUAL PROPERTY RIGHTS IS GRANTED BY THIS DOCUMENT.

TESTING AND OTHER QUALITY CONTROLS ARE USED TO THE EXTENT NATIONAL DEEMS NECESSARY TO SUPPORT NATIONAL'S PRODUCT WARRANTY. EXCEPT WHERE MANDATED BY GOVERNMENT REQUIREMENTS, TESTING OF ALL PARAMETERS OF EACH PRODUCT IS NOT NECESSARILY PERFORMED. NATIONAL ASSUMES NO LIABILITY FOR APPLICATIONS ASSISTANCE OR BUYER PRODUCT DESIGN. BUYERS ARE RESPONSIBLE FOR THEIR PRODUCTS AND APPLICATIONS USING NATIONAL COMPONENTS. PRIOR TO USING OR DISTRIBUTING ANY PRODUCTS THAT INCLUDE NATIONAL COMPONENTS, BUYERS SHOULD PROVIDE ADEQUATE DESIGN, TESTING AND OPERATING SAFEGUARDS.

EXCEPT AS PROVIDED IN NATIONAL'S TERMS AND CONDITIONS OF SALE FOR SUCH PRODUCTS, NATIONAL ASSUMES NO LIABILITY WHATSOEVER, AND NATIONAL DISCLAIMS ANY EXPRESS OR IMPLIED WARRANTY RELATING TO THE SALE AND/OR USE OF NATIONAL PRODUCTS INCLUDING LIABILITY OR WARRANTIES RELATING TO FITNESS FOR A PARTICULAR PURPOSE, MERCHANTABILITY, OR INFRINGEMENT OF ANY PATENT, COPYRIGHT OR OTHER INTELLECTUAL PROPERTY RIGHT.

LIFE SUPPORT POLICY

NATIONAL'S PRODUCTS ARE NOT AUTHORIZED FOR USE AS CRITICAL COMPONENTS IN LIFE SUPPORT DEVICES OR SYSTEMS WITHOUT THE EXPRESS PRIOR WRITTEN APPROVAL OF THE CHIEF EXECUTIVE OFFICER AND GENERAL COUNSEL OF NATIONAL SEMICONDUCTOR CORPORATION. As used herein:

Life support devices or systems are devices which (a) are intended for surgical implant into the body, or (b) support or sustain life and whose failure to perform when properly used in accordance with instructions for use provided in the labeling can be reasonably expected to result in a significant injury to the user. A critical component is any component in a life support device or system whose failure to perform can be reasonably expected to cause the failure of the life support device or system or to affect its safety or effectiveness.

National Semiconductor and the National Semiconductor logo are registered trademarks of National Semiconductor Corporation. All other brand or product names may be trademarks or registered trademarks of their respective holders.

Copyright© 2010 National Semiconductor Corporation

For the most current product information visit us at www.national.com



National Semiconductor Americas Technical Support Center
 Email: support@nsc.com
 Tel: 1-800-272-9959

National Semiconductor Europe Technical Support Center
 Email: europe.support@nsc.com

National Semiconductor Asia Pacific Technical Support Center
 Email: ap.support@nsc.com

National Semiconductor Japan Technical Support Center
 Email: jpn.feedback@nsc.com