

---

**PART NUMBER****BLF404-ROC**

---

**Rochester Electronics****Manufactured Components**

Rochester branded components are manufactured using either die/wafers purchased from the original suppliers or Rochester wafers recreated from the original IP. All re-creations are done with the approval of the Original Component Manufacturer. (OCM)

Parts are tested using original factory test programs or Rochester developed test solutions to guarantee product meets or exceeds the OCM data sheet.

**Quality Overview**

- ISO-9001
- AS9120 certification
- Qualified Manufacturers List (QML) MIL-PRF-38535
  - Class Q Military
  - Class V Space Level

**Qualified Suppliers List of Distributors (QSLD)**

- Rochester is a critical supplier to DLA and meets all industry and DLA standards.

Rochester Electronics, LLC is committed to supplying products that satisfy customer expectations for quality and are equal to those originally supplied by industry manufacturers.

---

*The original manufacturer's datasheet accompanying this document reflects the performance and specifications of the Rochester manufactured version of this device. Rochester Electronics guarantees the performance of its semiconductor products to the original OCM specifications. 'Typical' values are for reference purposes only. Certain minimum or maximum ratings may be based on product characterization, design, simulation, or sample testing.*

## IMPORTANT NOTICE

Dear customer,

As of December 7th, 2015 BL RF Power of NXP Semiconductors will operate as an independent company under the new trade name Ampleon, which will be used in future data sheets together with new contact details.

In data sheets, where the previous Philips references is mentioned, please use the new links as shown below.

<http://www.philips.semiconductors.com> use <http://www.ampleon.com>

<http://www.semiconductors.philips.com> use <http://www.ampleon.com> (Internet)

[sales.addresses@www.semiconductors.philips.com](mailto:sales.addresses@www.semiconductors.philips.com) use  
<http://www.ampleon.com/sales>

The copyright notice at the bottom of each page (or elsewhere in the document, depending on the version)

- © Koninklijke Philips Electronics N.V. (year). All rights reserved -  
is replaced with:

- © Ampleon B.V. (year). All rights reserved. -

If you have any questions related to the data sheet, please contact our nearest sales office (details via <http://www.ampleon.com/sales>).

Thank you for your cooperation and understanding,

Ampleon

# UHF power MOS transistor

# BLF404

### FEATURES

- High power gain
- Easy power control
- Gold metallization
- Good thermal stability
- Withstands full load mismatch
- Designed for broadband operation.

### APPLICATIONS

- Communication transmitters in the VHF/UHF range with a nominal supply voltage of 12.5 V.

### DESCRIPTION

Silicon N-channel enhancement mode vertical D-MOS power transistor in an 8-lead SOT409A SMD package with a ceramic cap.

### PINNING - SOT409A

PIN	DESCRIPTION
1, 8	source
2, 3	gate
4, 5	source
6, 7	drain

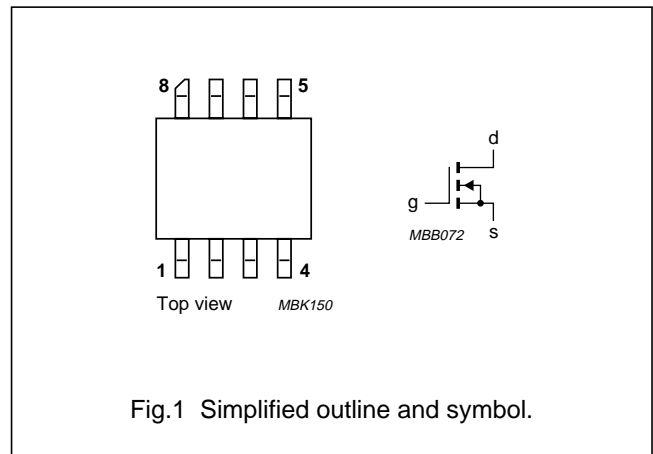

### QUICK REFERENCE DATA

RF performance at  $T_{mb} \leq 60 \text{ }^\circ\text{C}$  in a common source test circuit.

MODE OF OPERATION	f (MHz)	V <sub>DS</sub> (V)	P <sub>L</sub> (W)	G <sub>p</sub> (dB)	$\eta_D$ (%)
CW class-AB	500	12.5	4	$\geq 10$	$\geq 50$

### CAUTION

This product is supplied in anti-static packing to prevent damage caused by electrostatic discharge during transport and handling. For further information, refer to Philips specs.: SNW-EQ-608, SNW-FQ-302A, and SNW-FQ-302B.

UHF power MOS transistor

BLF404

**LIMITING VALUES**

In accordance with the Absolute Maximum Rating System (IEC 60134).

SYMBOL	PARAMETER	CONDITIONS	MIN.	MAX.	UNIT
$V_{DS}$	drain-source voltage		–	40	V
$V_{GS}$	gate-source voltage		–	$\pm 20$	V
$I_D$	drain current (DC)		–	1.5	A
$P_{tot}$	total power dissipation	$T_{mb} \leq 85\text{ }^\circ\text{C}$	–	8.3	W
$T_{stg}$	storage temperature		–65	+150	$^\circ\text{C}$
$T_j$	junction temperature		–	200	$^\circ\text{C}$

**THERMAL CHARACTERISTICS**

SYMBOL	PARAMETER	CONDITIONS	VALUE	UNIT
$R_{th\ j-mb}$	thermal resistance from junction to mounting base	$T_{mb} \leq 85\text{ }^\circ\text{C}$ , $P_{tot} = 8.3\text{ W}$	12.1	K/W

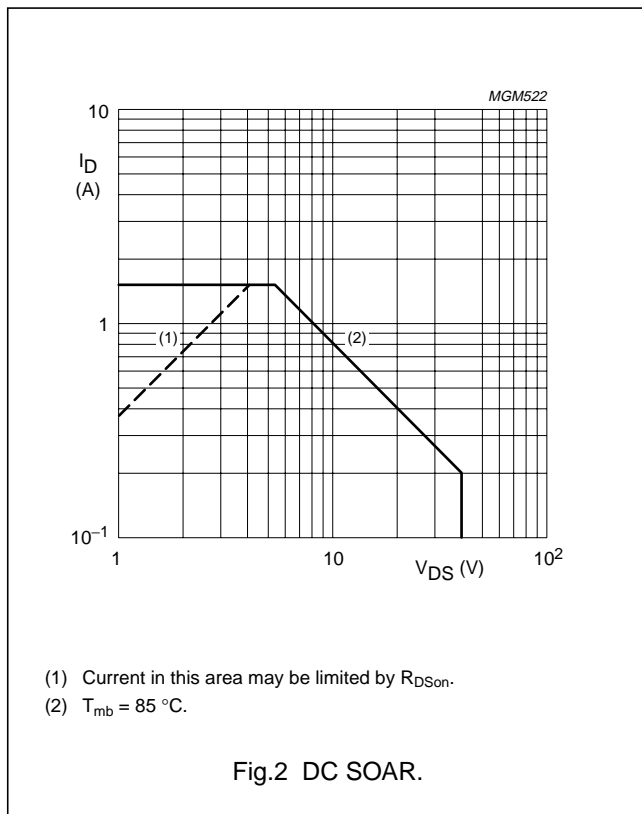

## UHF power MOS transistor

BLF404

## CHARACTERISTICS

 $T_j = 25\text{ °C}$  unless otherwise specified.

SYMBOL	PARAMETER	CONDITIONS	MIN.	TYP.	MAX.	UNIT
$V_{(BR)DSS}$	drain-source breakdown voltage	$V_{GS} = 0; I_D = 5\text{ mA}$	40	–	–	V
$V_{GSth}$	gate-source threshold voltage	$I_D = 50\text{ mA}; V_{DS} = 10\text{ V}$	2	–	4.5	V
$I_{DSS}$	drain-source leakage current	$V_{GS} = 0; V_{DS} = 12.5\text{ V}$	–	–	0.5	mA
$I_{GSS}$	gate-source leakage current	$V_{GS} = \pm 20\text{ V}; V_{DS} = 0$	–	–	1	$\mu\text{A}$
$I_{DSX}$	on-state drain current	$V_{GS} = 15\text{ V}; V_{DS} = 10\text{ V}$	–	2.3	–	A
$R_{DSon}$	drain-source on-state resistance	$I_D = 0.7\text{ A}; V_{GS} = 15\text{ V}$	–	1.8	2.7	$\Omega$
$g_{fs}$	forward transconductance	$I_D = 0.7\text{ A}; V_{DS} = 10\text{ V}$	200	270	–	mS
$C_{is}$	input capacitance	$V_{GS} = 0; V_{DS} = 12.5\text{ V}; f = 1\text{ MHz}$	–	14	–	pF
$C_{os}$	output capacitance	$V_{GS} = 0; V_{DS} = 12.5\text{ V}; f = 1\text{ MHz}$	–	17	–	pF
$C_{rs}$	feedback capacitance	$V_{GS} = 0; V_{DS} = 12.5\text{ V}; f = 1\text{ MHz}$	–	3	–	pF

 $V_{GS}$  group indicator

GROUP	LIMITS (V)		GROUP	LIMITS (V)	
	MIN.	MAX.		MIN.	MAX.
A	2.0	2.1	O	3.3	3.4
B	2.1	2.2	P	3.4	3.5
C	2.2	2.3	Q	3.5	3.6
D	2.3	2.4	R	3.6	3.7
E	2.4	2.5	S	3.7	3.8
F	2.5	2.6	T	3.8	3.9
G	2.6	2.7	U	3.9	4.0
H	2.7	2.8	V	4.0	4.1
J	2.8	2.9	W	4.1	4.2
K	2.9	3.0	X	4.2	4.3
L	3.0	3.1	Y	4.3	4.4
M	3.1	3.2	Z	4.4	4.5
N	3.2	3.3			

UHF power MOS transistor

BLF404

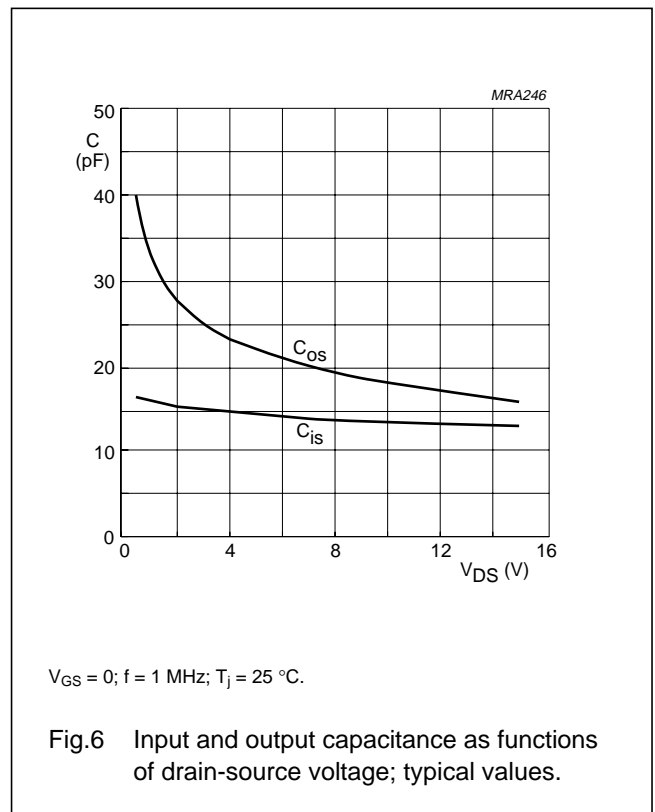
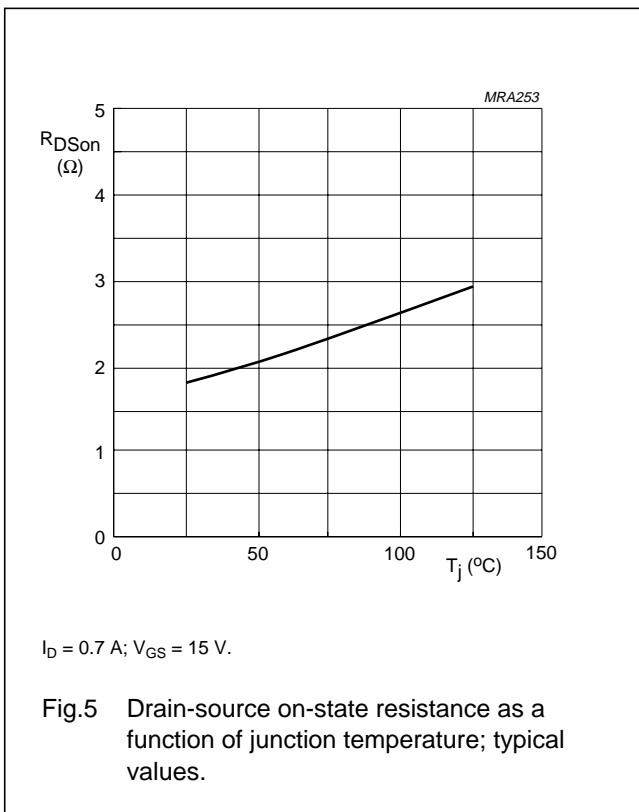
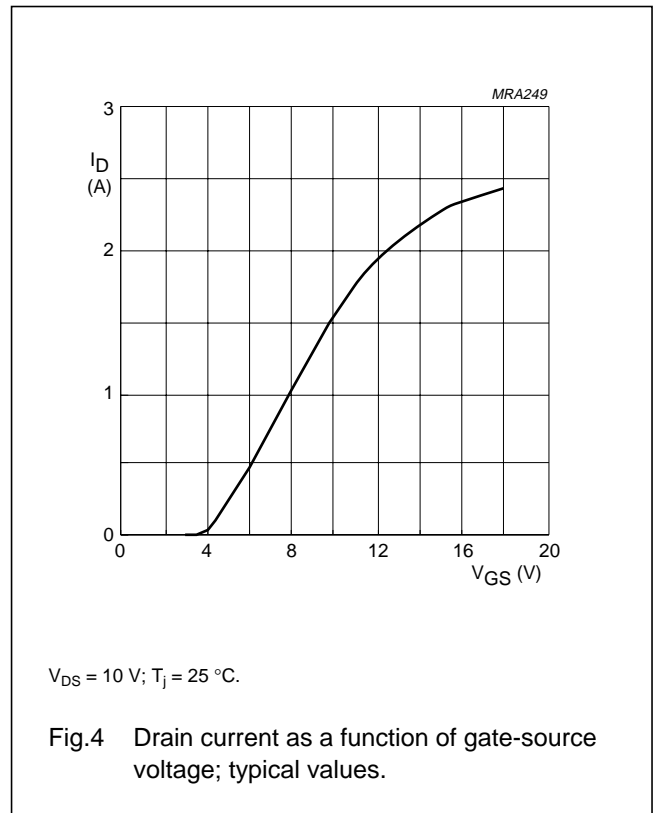
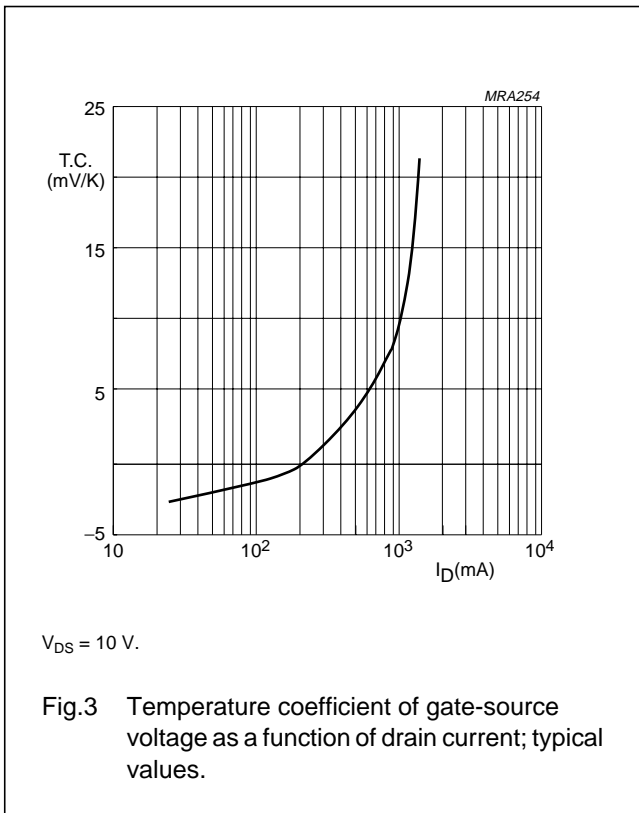

UHF power MOS transistor

BLF404

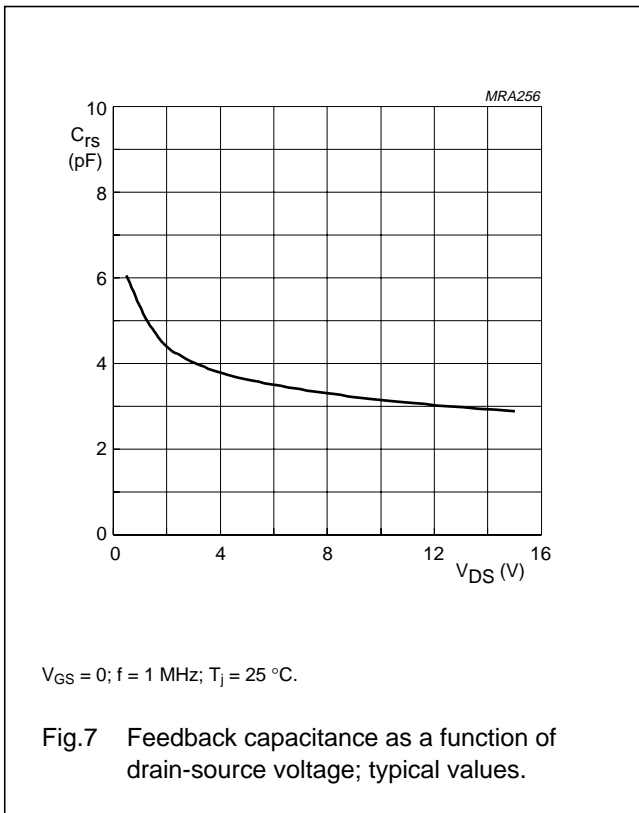

**APPLICATION INFORMATION**

RF performance at  $T_{mb} \leq 60$  °C in a common source test circuit with the device soldered on a printed-circuit board with through metallized holes.

MODE OF OPERATION	f (MHz)	$V_{DS}$ (V)	$I_{DQ}$ (A)	$P_L$ (W)	$G_p$ (dB)	$\eta_D$ (%)
CW, class-AB	500	12.5	50	4	$\geq 10$ typ. 11.5	$\geq 50$ typ. 55

**Ruggedness in class-AB operation**

The BLF404 is capable of withstanding a load mismatch corresponding to  $V_{SWR} = 10 : 1$  through all phases under the following conditions:  $f = 500$  MHz;  $V_{DS} = 12.5$  V;  $P_L = 4$  W;  $T_{mb} \leq 60$  °C.

UHF power MOS transistor

BLF404

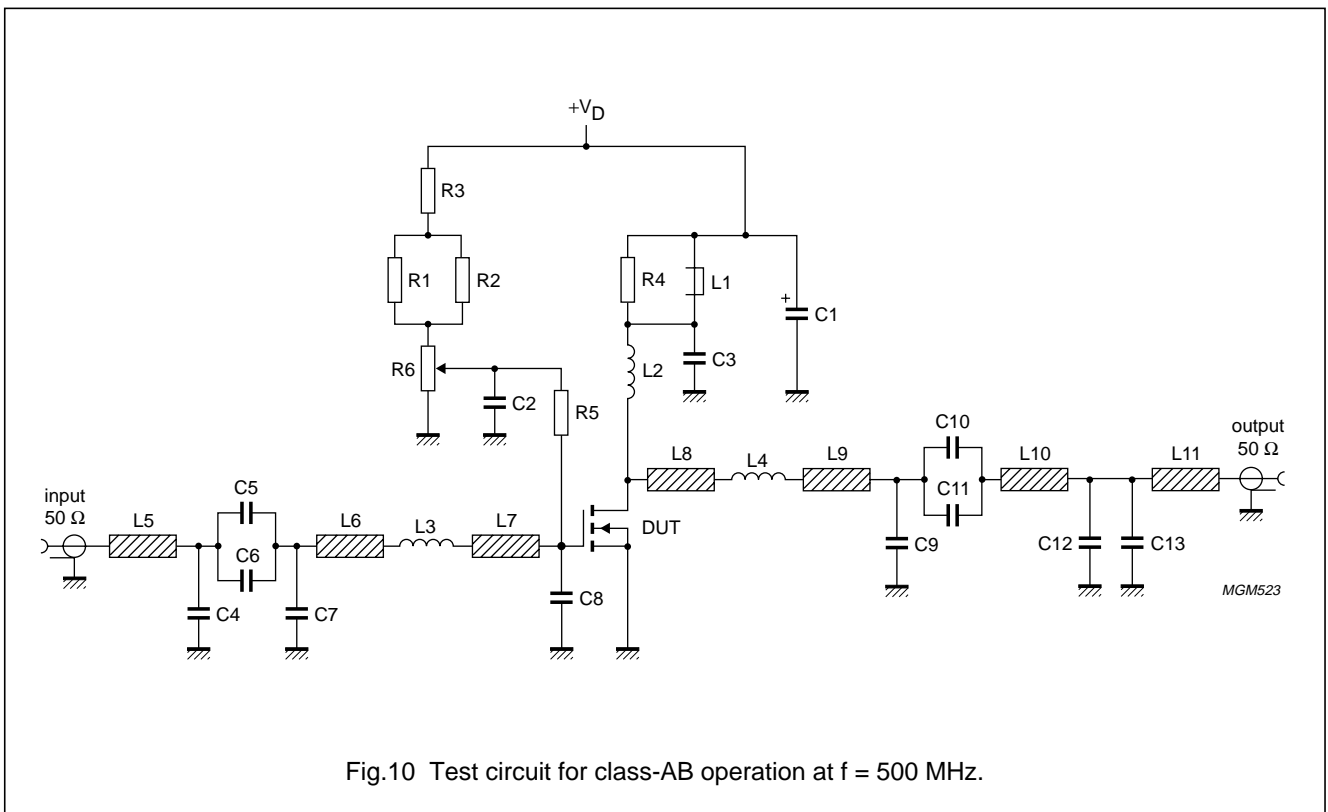
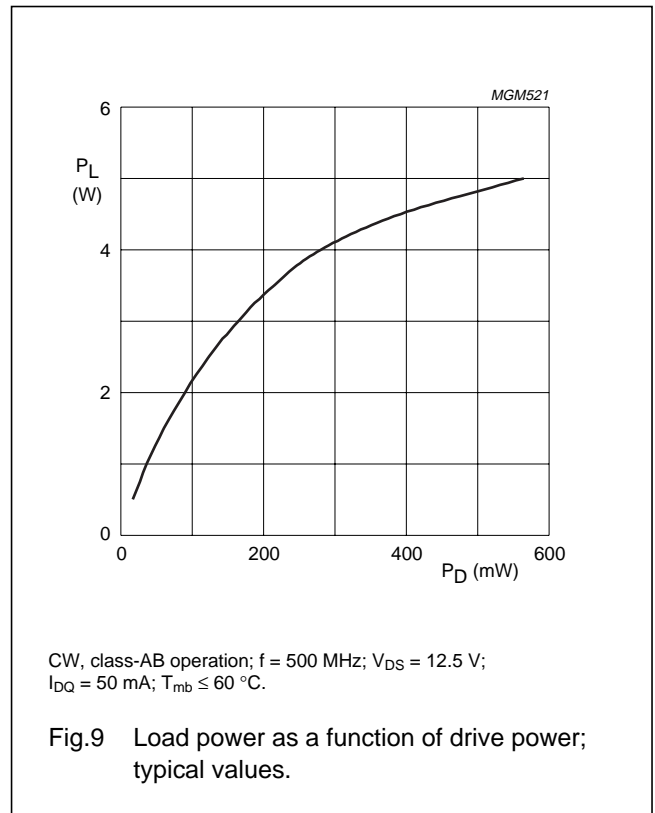
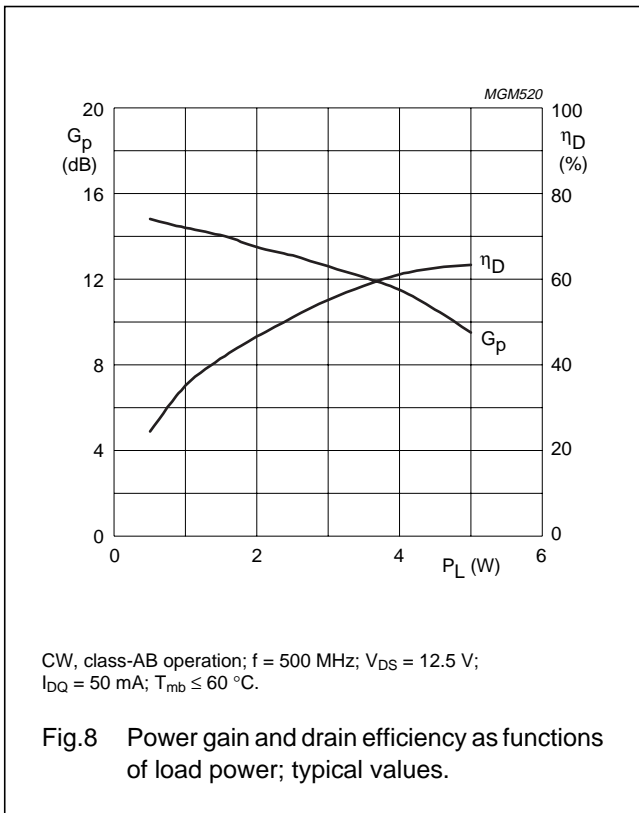



## UHF power MOS transistor

BLF404

List of components; see Figs 10 and 11.

COMPONENT	DESCRIPTION	VALUE	DIMENSIONS	CATALOGUE NO.
C1	electrolytic capacitor	4.7 $\mu$ F, 10 V		
C2, C3	multilayer ceramic chip capacitor	47 nF		
C4	multilayer ceramic chip capacitor; note 1	18 pF		
C5, C10	multilayer ceramic chip capacitor; note 1	180 pF		
C6, C11	multilayer ceramic chip capacitor; note 1	270 pF		
C7	multilayer ceramic chip capacitor; note 1	22 pF		
C8	multilayer ceramic chip capacitor; note 1	8.2 pF		
C9	multilayer ceramic chip capacitor; note 1	2.7 pF		
C12	multilayer ceramic chip capacitor; note 1	1.2 pF		
C13	multilayer ceramic chip capacitor; note 1	12 pF		
L1	2 turns 1 mm enamelled copper wire on a grade 4B1 Ferroxcube core		ext. dia. = 4.2 mm int. dia. = 2 mm length = 6 mm	
L2	3 turns 1 mm enamelled copper wire		int. dia. = 4.6 mm leads = 2 x 5 mm	
L3	bifilar coil		lead dia. = 0.8 mm	
L4	bifilar coil		lead dia. = 1 mm	
L5	stripline; note 2	50 $\Omega$	8.8 x 2.38 mm	
L6	stripline; note 2	50 $\Omega$	5.8 x 2.38 mm	
L7	stripline; note 2	50 $\Omega$	6.8 x 2.38 mm	
L8	stripline; note 2	50 $\Omega$	3.76 x 2.38 mm	
L9	stripline; note 2	50 $\Omega$	5.8 x 2.38 mm	
L10	stripline; note 2	50 $\Omega$	4.48 x 2.38 mm	
L11	stripline; note 2	50 $\Omega$	3.13 x 2.38 mm	
R1, R2	SMD resistor	3.9 k $\Omega$		
R3	metal film resistor	1 k $\Omega$ , 0.25 W		
R4	metal film resistor	22 $\Omega$ , 0.25 W		
R5	metal film resistor	10 k $\Omega$ , 0.25 W		
R6	potentiometer	10 k $\Omega$		

## Notes

- American Technical Ceramics type 100A or capacitor of same quality.
- The striplines are on a double copper-clad printed-circuit board, with DUROID dielectric ( $\epsilon_r = 2.2$ ); thickness 0.79 mm, thickness of the copper sheet 2 x 35  $\mu$ m.

UHF power MOS transistor

BLF404

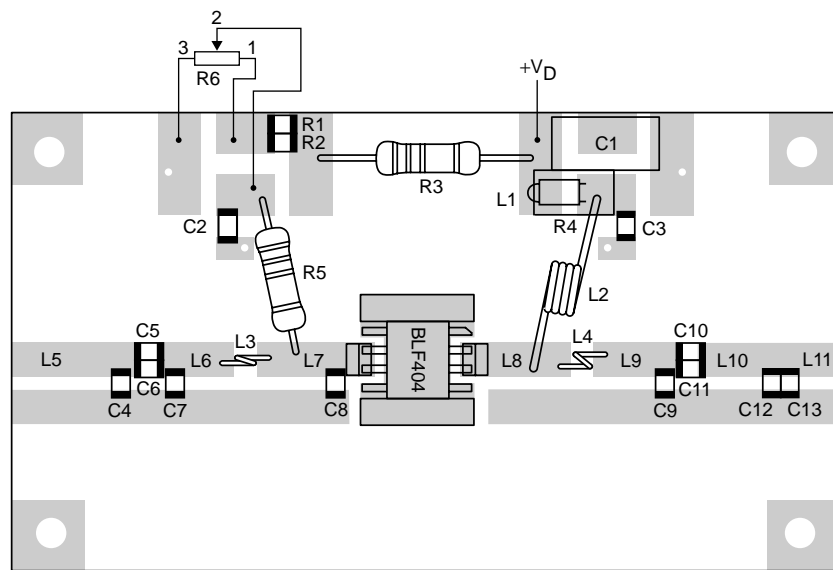
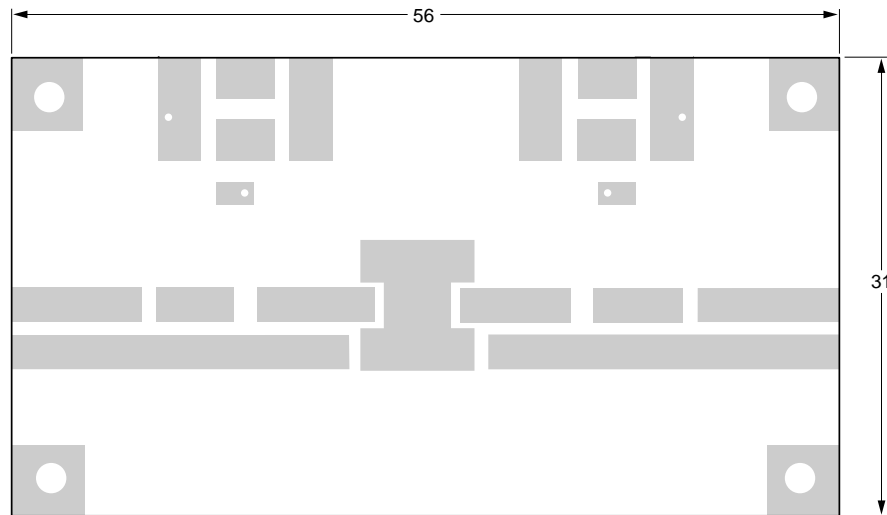

MGM524

Dimensions in mm.

The components are situated on one side of the copper-clad printed-circuit board, the other side is unetched and serves as a ground plane. Earth connections from the component side to the ground plane are made by through metallization.

Fig.11 Component layout for 500 MHz class-AB test circuit.

UHF power MOS transistor

BLF404

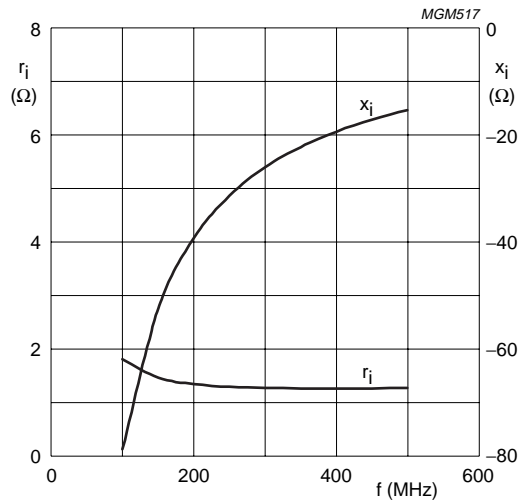

CW, class-AB operation;  $V_{DS} = 12.5$  V;  $I_D = 50$  mA;  
 $P_L = 4$  W;  $T_{mb} \leq 60$  °C.

Fig.12 Input impedance as a function of frequency (series components); typical values.

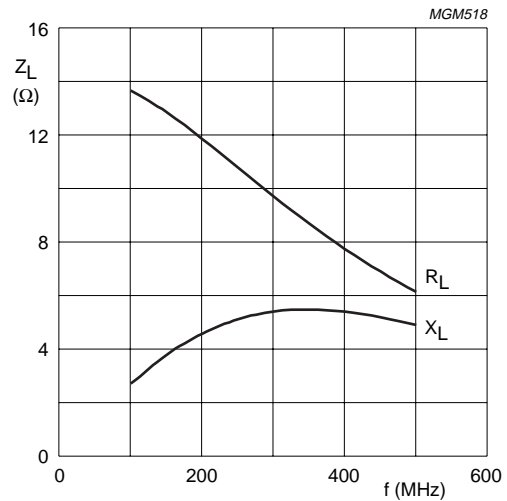

CW, class-AB operation;  $V_{DS} = 12.5$  V;  $I_D = 50$  mA;  
 $P_L = 4$  W;  $T_{mb} \leq 60$  °C.

Fig.13 Load impedance as a function of frequency (series components); typical values.

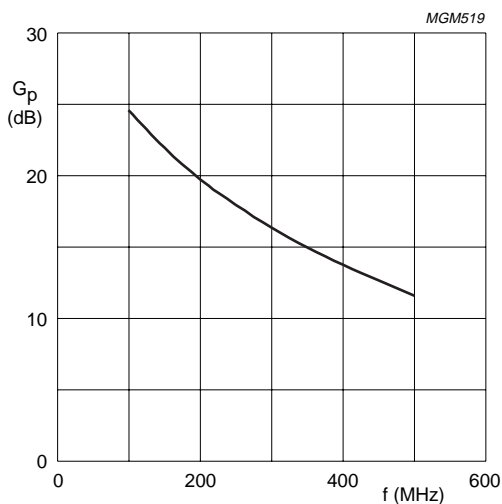

CW, class-AB operation;  $V_{DS} = 12.5$  V;  $I_{DQ} = 50$  mA;  
 $P_L = 4$  W;  $T_{mb} \leq 60$  °C.

Fig.14 Power gain as a function of frequency (series components); typical values.

UHF power MOS transistor

BLF404

**MOUNTING RECOMMENDATIONS**

Both the metallized ground plate and the device leads contribute to the heat flow. It is recommended that the transistor be mounted on a grounded metallized area of the printed-circuit board. This area should be of maximum 0.8 mm thickness and include at least 12 x 0.5 diameter through metallized holes filled with solder.

A thermal resistance  $R_{th(mb-h)}$  of 5 K/W can be achieved if heatsink compound is applied when the transistor is mounted on the printed-circuit board.

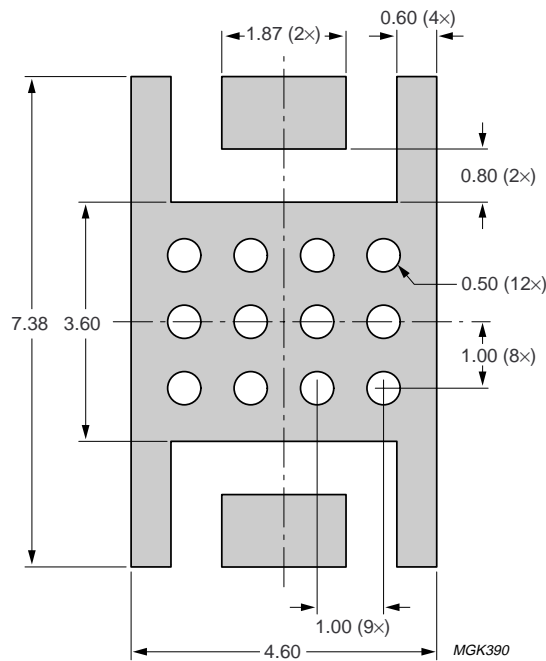

Dimensions in mm.

Fig.15 Reflow soldering footprint for SOT409A.

## UHF power MOS transistor

## BLF404

**BLF404 scattering parameters** $V_{DS} = 12.5\text{ V}$ ;  $I_D = 50\text{ mA}$ ; note 1.

f (MHz)	S <sub>11</sub>		S <sub>21</sub>		S <sub>12</sub>		S <sub>22</sub>	
	s <sub>11</sub>	∠ Φ	s <sub>21</sub>	∠ Φ	s <sub>12</sub>	∠ Φ	s <sub>22</sub>	∠ Φ
5	1.00	-5.2	12.97	176.0	0.01	86.0	0.96	-6.0
10	0.99	-10.1	12.89	171.9	0.02	82.2	0.96	-12.0
20	0.98	-20.6	12.61	164.1	0.03	74.8	0.95	-23.5
30	0.96	-30.4	12.18	156.6	0.05	67.6	0.93	-34.7
40	0.93	-39.6	11.62	149.6	0.06	60.9	0.91	-45.1
50	0.89	-48.0	11.00	143.2	0.07	54.8	0.89	-54.7
60	0.86	-55.8	10.37	137.4	0.08	49.4	0.87	-63.5
70	0.83	-62.9	9.74	132.2	0.09	44.4	0.85	-71.4
80	0.80	-69.4	9.15	127.5	0.10	40.1	0.83	-78.5
90	0.78	-75.3	8.60	123.2	0.10	36.2	0.82	-84.8
100	0.75	-80.7	8.08	119.3	0.10	32.7	0.80	-90.5
125	0.71	-92.2	6.96	110.7	0.11	25.1	0.77	-102.6
150	0.68	-101.4	6.03	103.9	0.12	19.1	0.76	-111.9
175	0.66	-108.9	5.30	98.3	0.12	14.4	0.74	-119.2
200	0.64	-115.2	4.73	93.2	0.12	10.2	0.74	-125.1
250	0.63	-124.9	3.81	84.5	0.12	3.5	0.73	-134.1
300	0.64	-132.5	3.19	77.4	0.12	-1.8	0.74	-140.5
350	0.64	-138.6	2.70	71.2	0.11	-6.1	0.74	-145.3
400	0.66	-143.8	2.34	65.7	0.11	-9.7	0.75	-149.1
450	0.67	-148.4	2.03	60.5	0.10	-12.5	0.76	-152.4
500	0.69	-152.6	1.80	56.0	0.09	-15.1	0.78	-155.2
600	0.72	-160.2	1.44	47.7	0.08	-18.2	0.80	-159.9
700	0.75	-167.1	1.18	40.4	0.07	-18.6	0.82	-163.9
800	0.78	-173.6	0.99	34.4	0.05	-15.0	0.84	-167.5
900	0.81	-179.8	0.84	29.2	0.04	-6.0	0.86	-170.7
1000	0.83	174.3	0.73	25.1	0.04	9.9	0.88	-173.6

**Note**

1. For more extensive s-parameters see internet:  
<http://www.semiconductors.philips.com/markets/communications/wirelesscommunications/broadcast>

UHF power MOS transistor

BLF404

PACKAGE OUTLINE

Ceramic surface mounted package; 8 leads

SOT409A

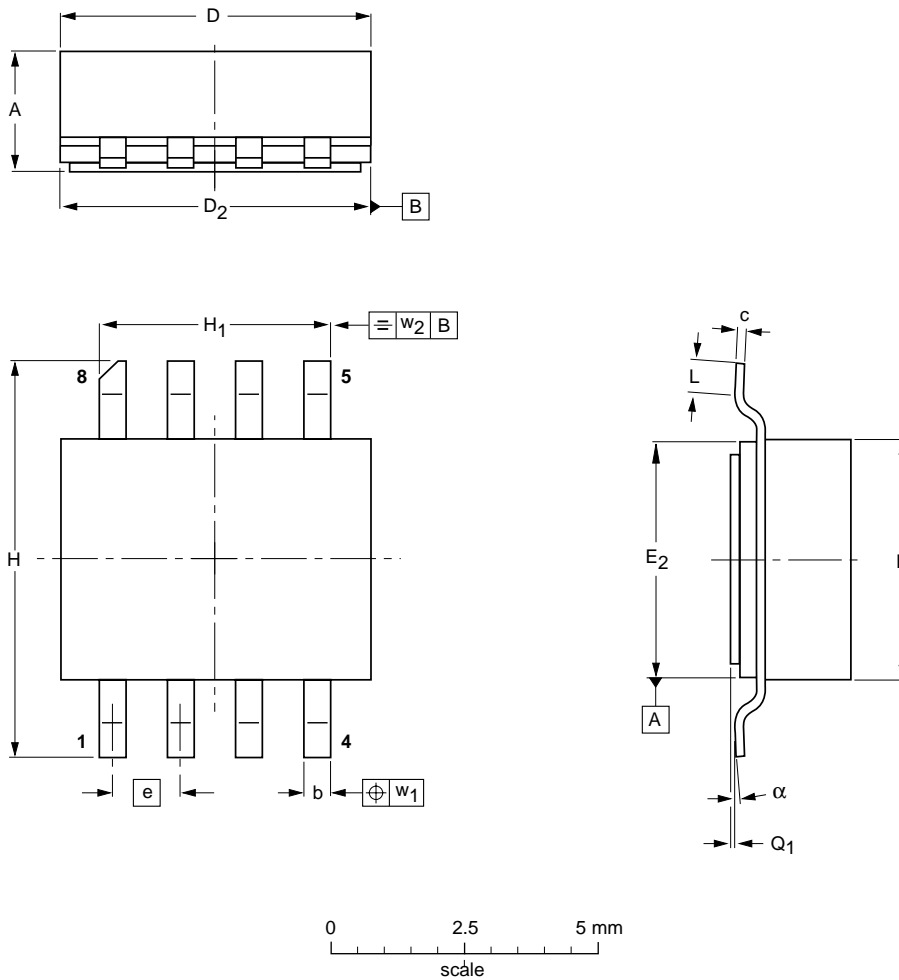

DIMENSIONS (millimetre dimensions are derived from the original inch dimensions)

UNIT	A	b	c	D	D <sub>2</sub>	E	E <sub>2</sub>	e	H	H <sub>1</sub>	L	Q <sub>1</sub>	w <sub>1</sub>	w <sub>2</sub>	$\alpha$
mm	2.36 2.06	0.58 0.43	0.23 0.18	5.94 5.03	5.16 5.00	4.93 4.01	4.14 3.99	1.27	7.47 7.26	4.39 4.24	1.02 0.51	0.10 0.00	0.25	0.25	7° 0°
inches	0.093 0.081	0.023 0.017	0.009 0.007	0.234 0.198	0.203 0.197	0.194 0.158	0.163 0.157	0.050	0.294 0.286	0.173 0.167	0.040 0.020	0.004 0.000	0.010	0.010	7° 0°

OUTLINE VERSION	REFERENCES				EUROPEAN PROJECTION	ISSUE DATE
	IEC	JEDEC	EIAJ			
SOT409A						98-01-27

## UHF power MOS transistor

BLF404

## DATA SHEET STATUS

LEVEL	DATA SHEET STATUS <sup>(1)</sup>	PRODUCT STATUS <sup>(2)(3)</sup>	DEFINITION
I	Objective data	Development	This data sheet contains data from the objective specification for product development. Philips Semiconductors reserves the right to change the specification in any manner without notice.
II	Preliminary data	Qualification	This data sheet contains data from the preliminary specification. Supplementary data will be published at a later date. Philips Semiconductors reserves the right to change the specification without notice, in order to improve the design and supply the best possible product.
III	Product data	Production	This data sheet contains data from the product specification. Philips Semiconductors reserves the right to make changes at any time in order to improve the design, manufacturing and supply. Relevant changes will be communicated via a Customer Product/Process Change Notification (CPCN).

## Notes

1. Please consult the most recently issued data sheet before initiating or completing a design.
2. The product status of the device(s) described in this data sheet may have changed since this data sheet was published. The latest information is available on the Internet at URL <http://www.semiconductors.philips.com>.
3. For data sheets describing multiple type numbers, the highest-level product status determines the data sheet status.

## DEFINITIONS

**Short-form specification** — The data in a short-form specification is extracted from a full data sheet with the same type number and title. For detailed information see the relevant data sheet or data handbook.

**Limiting values definition** — Limiting values given are in accordance with the Absolute Maximum Rating System (IEC 60134). Stress above one or more of the limiting values may cause permanent damage to the device. These are stress ratings only and operation of the device at these or at any other conditions above those given in the Characteristics sections of the specification is not implied. Exposure to limiting values for extended periods may affect device reliability.

**Application information** — Applications that are described herein for any of these products are for illustrative purposes only. Philips Semiconductors make no representation or warranty that such applications will be suitable for the specified use without further testing or modification.

## DISCLAIMERS

**Life support applications** — These products are not designed for use in life support appliances, devices, or systems where malfunction of these products can reasonably be expected to result in personal injury. Philips Semiconductors customers using or selling these products for use in such applications do so at their own risk and agree to fully indemnify Philips Semiconductors for any damages resulting from such application.

**Right to make changes** — Philips Semiconductors reserves the right to make changes in the products - including circuits, standard cells, and/or software - described or contained herein in order to improve design and/or performance. When the product is in full production (status 'Production'), relevant changes will be communicated via a Customer Product/Process Change Notification (CPCN). Philips Semiconductors assumes no responsibility or liability for the use of any of these products, conveys no licence or title under any patent, copyright, or mask work right to these products, and makes no representations or warranties that these products are free from patent, copyright, or mask work right infringement, unless otherwise specified.

# ***Philips Semiconductors – a worldwide company***

## **Contact information**

For additional information please visit <http://www.semiconductors.philips.com>. Fax: +31 40 27 24825

For sales offices addresses send e-mail to: [sales.addresses@www.semiconductors.philips.com](mailto:sales.addresses@www.semiconductors.philips.com).

© Koninklijke Philips Electronics N.V. 2003

SCA75

All rights are reserved. Reproduction in whole or in part is prohibited without the prior written consent of the copyright owner.

The information presented in this document does not form part of any quotation or contract, is believed to be accurate and reliable and may be changed without notice. No liability will be accepted by the publisher for any consequence of its use. Publication thereof does not convey nor imply any license under patent- or other industrial or intellectual property rights.

Printed in The Netherlands

613524/04/pp15

Date of release: 2003 Sep 26

Document order number: 9397 750 11603

*Let's make things better.*

**Philips  
Semiconductors**



**PHILIPS**