

CLC405

Low Cost, Low Power, 110MHz Op Amp with Disable

General Description

The CLC405 is a low cost, wideband (110MHz) op amp featuring a TTL-compatible disable which quickly switches off in 18ns and back on in 40ns. While disabled, the CLC405 has a very high input/output impedance and its total power consumption drops to a mere 8mW. When enabled, the CLC405 consumes only 35mW and can source or sink an output current of 60mA. These features make the CLC405 a versatile, high speed solution for demanding applications that are sensitive to both power and cost.

Utilizing National's proven architectures, this current feedback amplifier surpasses the performance of alternative solutions and sets new standards for low power at a low price. This power conserving op amp achieves low distortion with -72dBc and -70dBc for second and third harmonics respectively. Many high source impedance applications will benefit from the CLC405's $6\text{M}\Omega$ input impedance. And finally, designers will have a bipolar part with an exceptionally low 100nA non-inverting bias current.

With 0.1dB flatness to 50MHz and low differential gain and phase errors, the CLC405 is an ideal part for professional video processing and distribution. However, the 110MHz -3dB bandwidth ($A_v = +2$) coupled with a $350\text{V}/\mu\text{s}$ slew rate also make the CLC405 a perfect choice in cost sensitive applications such as video monitors, fax machines, copiers, and CATV systems.

Features

- Low cost
- Very low input bias current: 100nA
- High input impedance: $6\text{M}\Omega$
- 110MHz -3dB bandwidth ($A_v = +2$)
- Low power: $I_{cc} = 3.5\text{mA}$

- Ultra fast enable/disable times
- High output current: 60mA

Applications

- Desktop video systems
- Multiplexers
- Video distribution
- Flash A/D driver
- High speed switch/driver
- High source impedance applications
- Peak detector circuits
- Professional video processing
- High resolution monitors

Frequency Response ($A_v = +2\text{V/V}$)

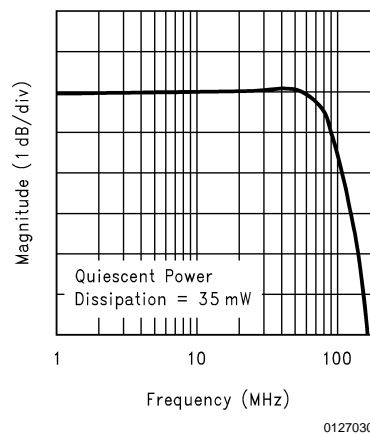

Connection Diagram

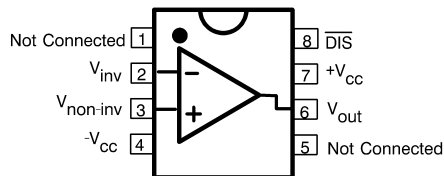

Pinout
DIP & SOIC

01270333

Typical Application

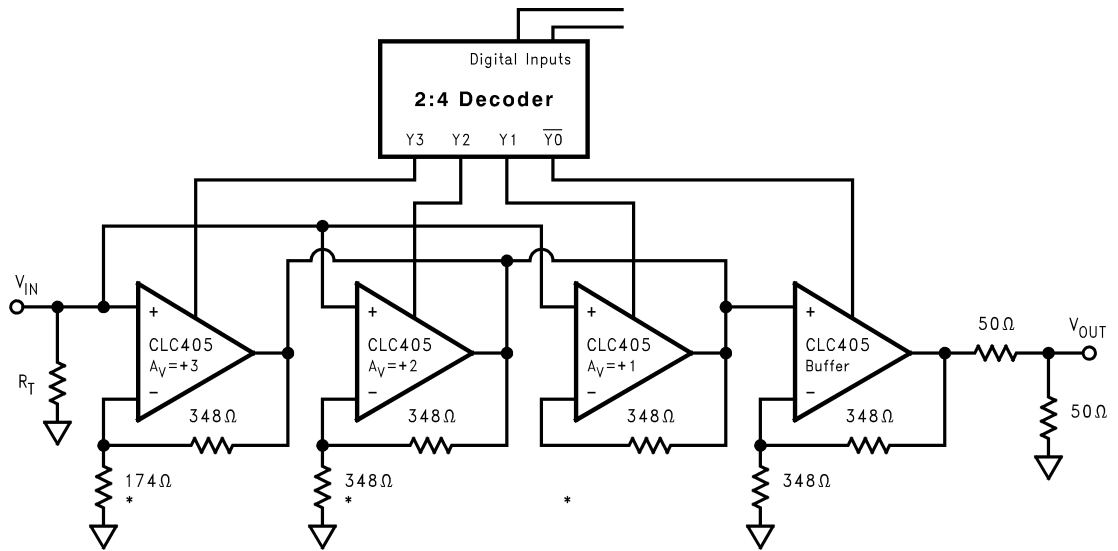

*NOTE: Selectable gains can be changed by using different R_g resistors.

01270303

Wideband Digitally Controlled Programmable Gain Amplifier

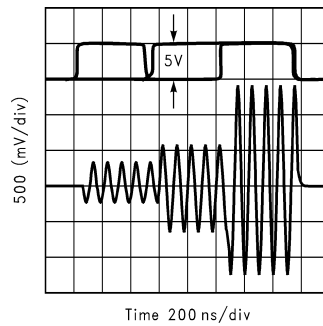

01270302

Channel Switching

Ordering Information

Package	Temperature Range Industrial	Part Number	Package Marking	NSC Drawing
8-pin plastic DIP	-40°C to +85°C	CLC405AJP	CLC405AJP	N08E
8-pin plastic SOIC	-40°C to +85°C	CLC405AJE	CLC405AJE	M08A

Absolute Maximum Ratings (Note 1)

If Military/Aerospace specified devices are required, please contact the National Semiconductor Sales Office/Distributors for availability and specifications.

Supply Voltage (V_{CC})	$\pm 7V$
I_{OUT} is short circuit protected to ground	
Common Mode Input Voltage	$\pm V_{CC}$
Junction Temperature	$+150^{\circ}C$
Storage Temperature Range	$-65^{\circ}C$ to $+150^{\circ}C$

Lead Temperature (soldering 10 sec)

 $+300^{\circ}C$ **Operating Ratings**

Thermal Resistance

Package	(θ_{JC})	(θ_{JA})
MDIP	$75^{\circ}C/W$	$130^{\circ}C/W$
SOIC	$130^{\circ}C/W$	$150^{\circ}C/W$

Electrical Characteristics

$A_V = +2$, $R_f = 348\Omega$; $V_{CC} = \pm 5V$, $R_L = 100\Omega$ unless specified

Notes	Parameter	Conditions	Typ	Min/Max (Note 2)			Units
	Ambient Temperature	CLC405AJ	$+25^{\circ}C$	$+25^{\circ}C$	0 to $70^{\circ}C$	-40 to $85^{\circ}C$	
Frequency Domain Response							
	-3dB Bandwidth	$V_{OUT} < 1.0V_{PP}$	110	75	50	45	MHz
(Note 3)		$V_{OUT} < 5.0V_{PP}$	42	31	27	26	MHz
	-3dB Bandwidth $A_V = +1$	$V_{OUT} < 0.5V_{PP}$ ($R_f = 2K$)	135	-	-	-	MHz
	$\pm 0.1dB$ Bandwidth	$V_{OUT} < 1.0V_{PP}$	50	15	-	-	MHz
	Gain Flatness	$V_{OUT} < 1.0V_{PP}$					
	Peaking	DC to 200MHz	0	0.6	0.8	1.0	dB
	Rolloff	$< 30MHz$	0.05	0.3	0.4	0.5	dB
	Linear Phase Deviation	$< 20MHz$	0.3	0.6	0.7	0.7	deg
	Differential Gain	NTSC, $R_L = 150\Omega$	0.01	0.03	0.04	0.05	%
(Note 4)		NTSC, $R_L = 150\Omega$	0.01				%
	Differential Phase	NTSC, $R_L = 150\Omega$	0.25	0.4	0.5	0.55	deg
(Note 4)		NTSC, $R_L = 150\Omega$	0.08				deg
Time Domain Response							
	Rise and Fall Time	2V Step	5	7.5	8.2	8.4	ns
	Settling Time to 0.05%	2V Step	18	27	36	39	ns
	Overshoot	2V Step	3	12	12	12	%
	Slew Rate	$A_V = +2$ 2V Step	350	260	225	215	V/ μs
		$A_V = -1$ 1V Step	650	-	-	-	V/ μs
Distortion And Noise Response							
(Note 5)	2nd Harmonic Distortion	$2V_{PP}$, 1MHz/10MHz	$-72/-52$	-46	-45	-44	dBc
(Note 5)	3rd Harmonic Distortion	$2V_{PP}$, 1MHz/10MHz	$-70/-57$	-50	-47	-46	dBc
	Equivalent Input Noise						
	Non-Inverting Voltage	$> 1MHz$	5	6.3	6.6	6.7	nV/ \sqrt{Hz}
	Inverting Current	$> 1MHz$	12	15	16	17	pA/ \sqrt{Hz}
	Non-Inverting Current	$> 1MHz$	3	3.8	4	4.2	pA/ \sqrt{Hz}
Static DC Performance							
(Note 6)	Input Offset Voltage		1	5	7	8	mV
	Average Drift		30	50		50	$\mu V/^{\circ}C$
(Note 6)	Input Bias Current	Non-Inverting	100	900	1600	2800	nA
	Average Drift		3		8	11	nA/ $^{\circ}C$
(Note 6)	Input Bias Current	Inverting	1	5	7	10	μA
	Average Drift		17		40	45	nA/ $^{\circ}C$

Electrical Characteristics (Continued)

$A_V = +2$, $R_f = 348\Omega$; $V_{CC} = \pm 5V$, $R_L = 100\Omega$ unless specified

Notes	Parameter	Conditions	Typ	Min/Max (Note 2)		Units	
	Power Supply Rejection Ratio	DC	52	47	46	45	dB
	Common Mode Rejection Ratio	DC	50	45	44	43	dB
(Note 6)	Supply Current	$R_L = \infty$	3.5	4.0	4.1	4.4	mA
(Note 6)	Disabled	$R_L = \infty$	0.8	0.9	0.95	1	mA
Switching DC Performance							
	Turn On Time		40	55	58	58	ns
	Turn Off Time	to > 50dB attn. @ 10MHz	18	26	30	32	ns
	Off Isolation	10MHz	59	55	55	55	dB
	High Input Voltage	V_{IH}		2	2	2	V
	Low Input Voltage	V_{IL}		0.8	0.8	0.8	V
Miscellaneous Performance							
	Input Resistance	Non- Inverting	6	3	2.4	1	M Ω
	Input Resistance	Inverting	182				Ω
	Input Capacitance	Non- Inverting	1	2	2	2	pF
	Common Mode Input Range		± 2.2	1.8	1.7	1.5	V
	Output Voltage Range	$R_L = 100\Omega$	+3.5,-2.8	+3.1,-2.7	+2.9,-2.6	+2.4,-1.6	V
	Output Voltage Range	$R_L = \infty$	+4.0,-3.3	+3.9,-3.2	+3.8,-3.1	+3.7,-2.8	V
	Output Current		40	40	38	20	mA
	Output Resistance, Closed Loop		0.06	0.2	0.25	0.4	Ω

Note 1: "Absolute Maximum Ratings" are those values beyond which the safety of the device cannot be guaranteed. They are not meant to imply that the devices should be operated at these limits. The table of "Electrical Characteristics" specifies conditions of device operation.

Note 2: Max/min ratings are based on product characterization and simulation. Individual parameters are tested as noted. Outgoing quality levels are determined from tested parameters.

Note 3: At temps <0°C, spec is guaranteed for R_L 500 Ω .

Note 4: An 825 Ω =pull-down resistor is connected between V_O and $-V_{CC}$

Note 5: Guaranteed at 10MHz

Note 6: AJ-level: spec. is 100% tested at +25°C.

Typical Performance Characteristics ($A_V = +2$, $R_f = 348\Omega$; $V_{CC} = \pm 5V$, $R_L = 100\Omega$ Unless Specified).

Non-Inverting Frequency Response

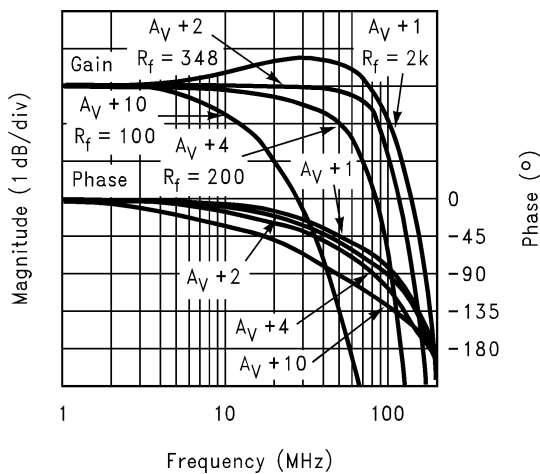

01270304

Inverting Frequency Response

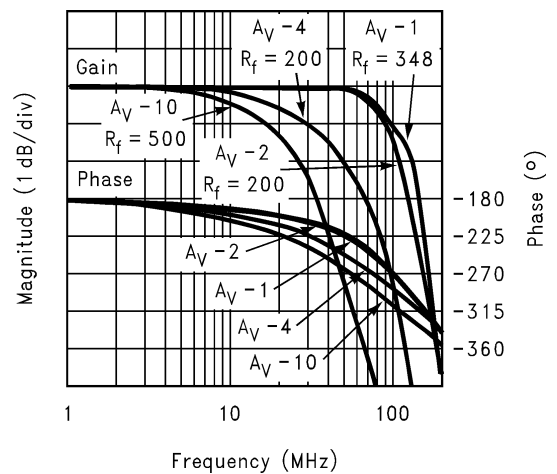

01270305

Typical Performance Characteristics ($A_V = +2$, $R_f = 348\Omega$; $V_{CC} = \pm 5V$, $R_L = 100\Omega$ Unless Specified). (Continued)

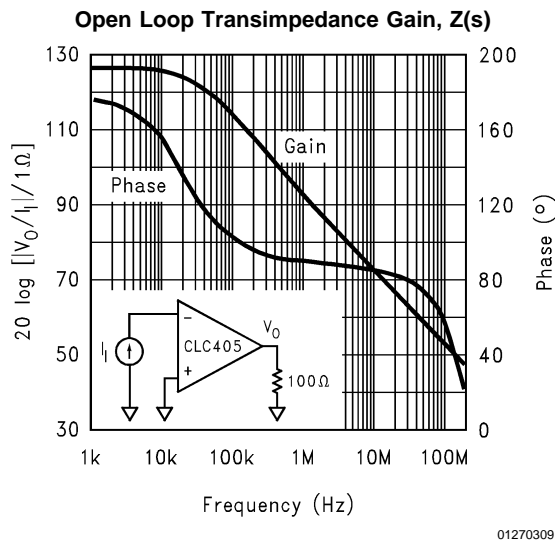
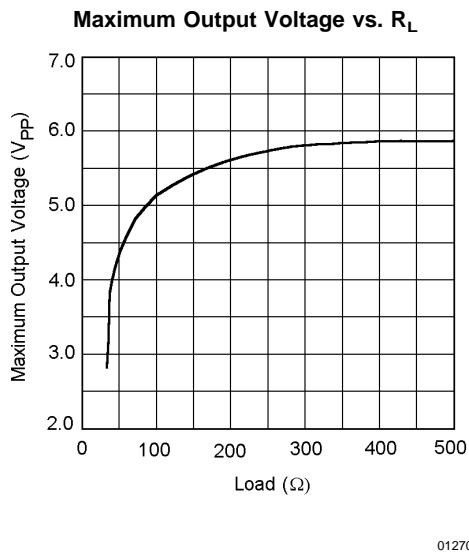
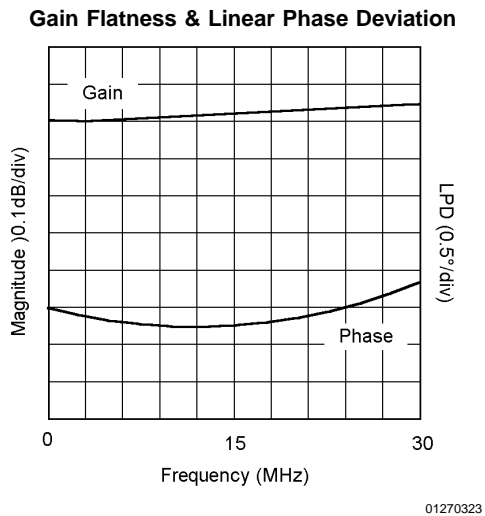
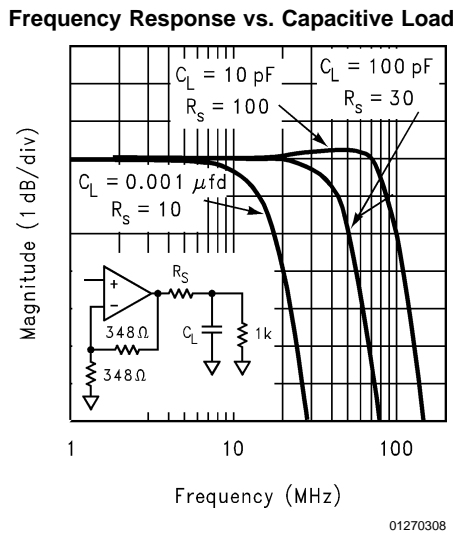
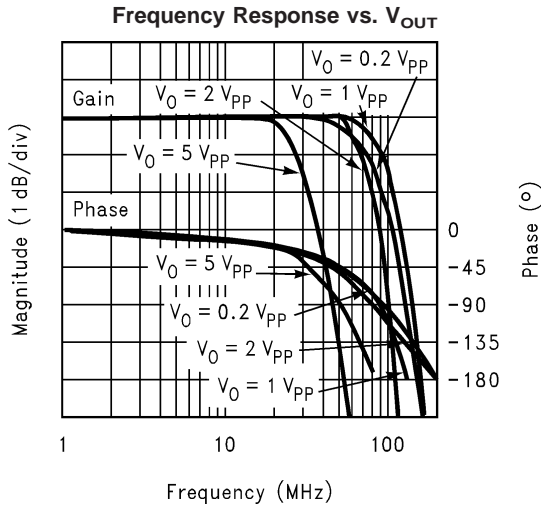
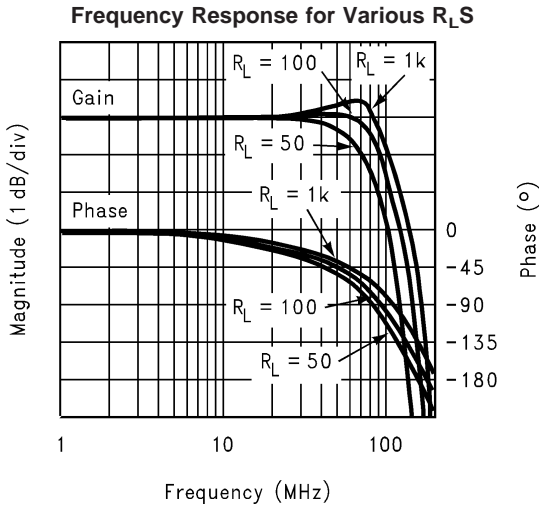

Typical Performance Characteristics ($A_V = +2$, $R_f = 348\Omega$; $V_{CC} = \pm 5V$, $R_L = 100\Omega$ Unless Specified). (Continued)

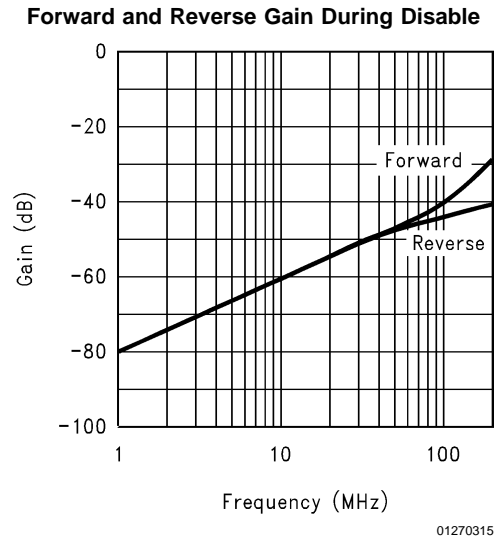
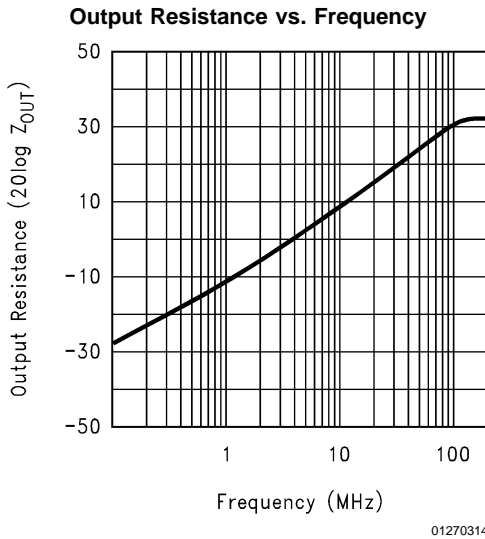
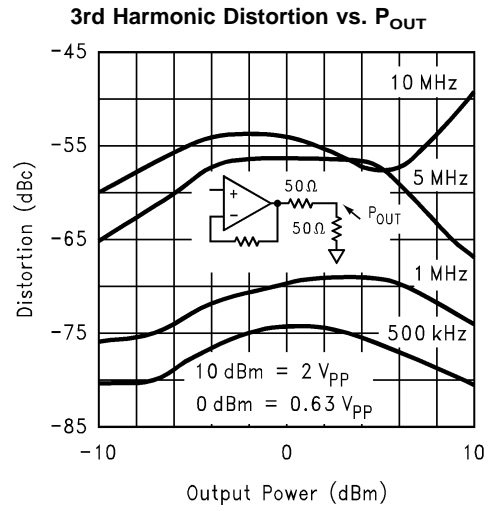
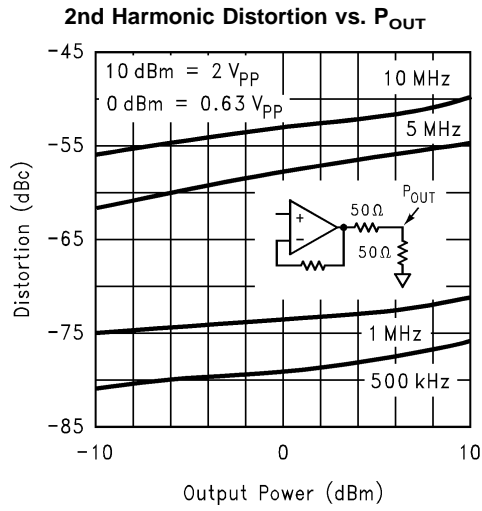
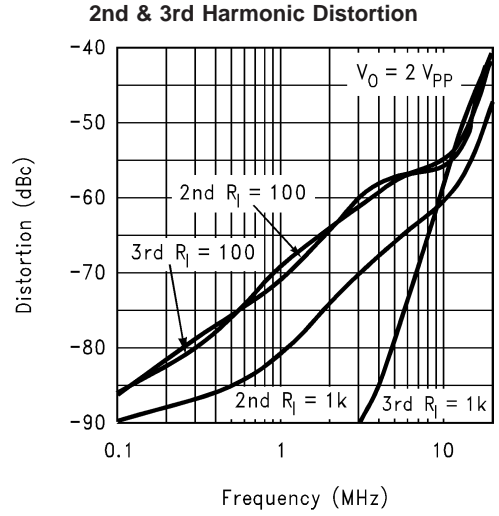
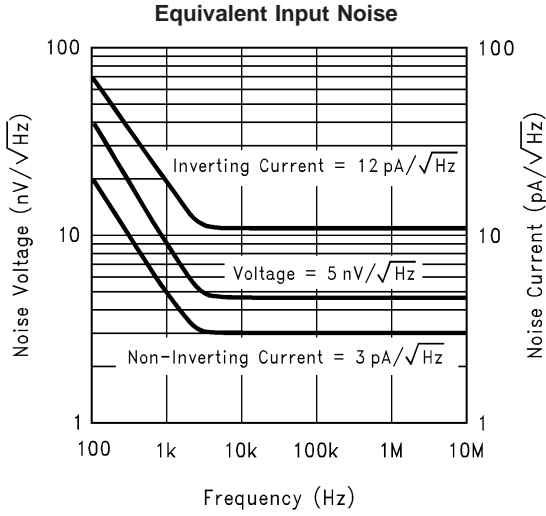

Typical Performance Characteristics ($A_V = +2$, $R_f = 348\Omega$; $V_{CC} = \pm 5V$, $R_L = 100\Omega$ Unless Specified). (Continued)

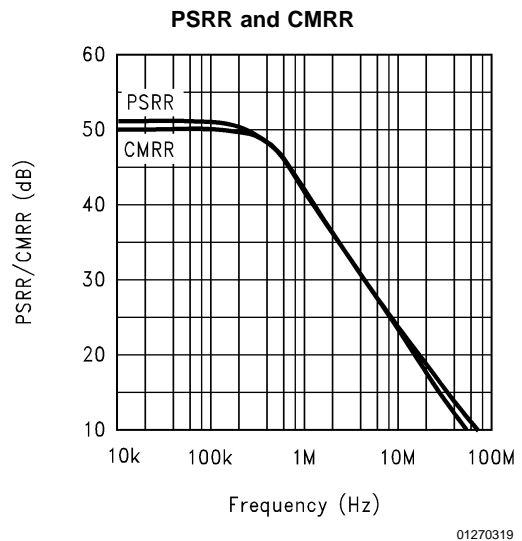
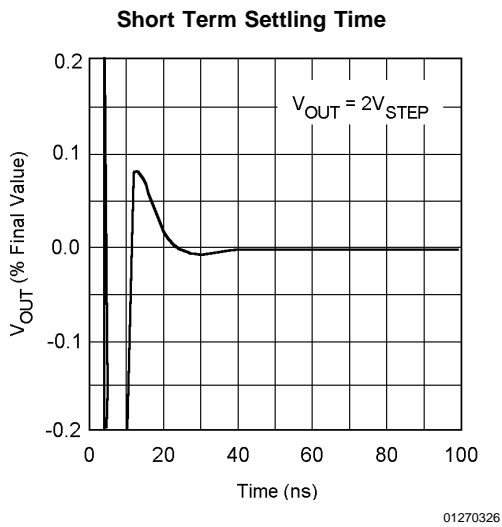
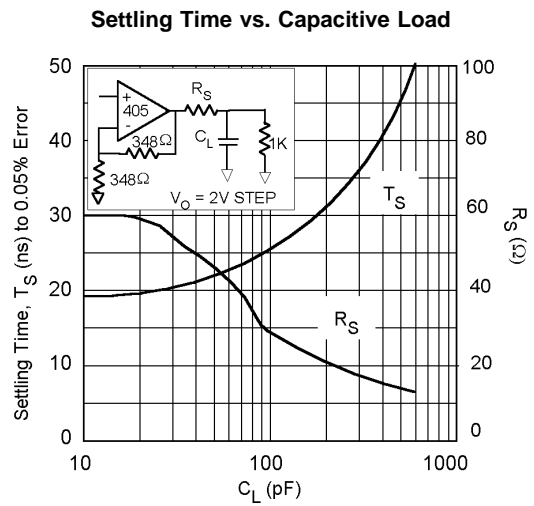
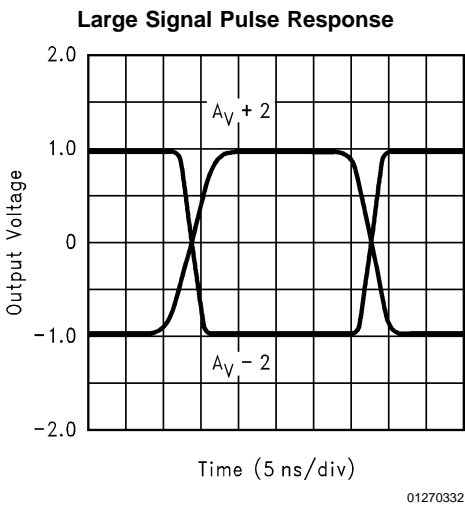
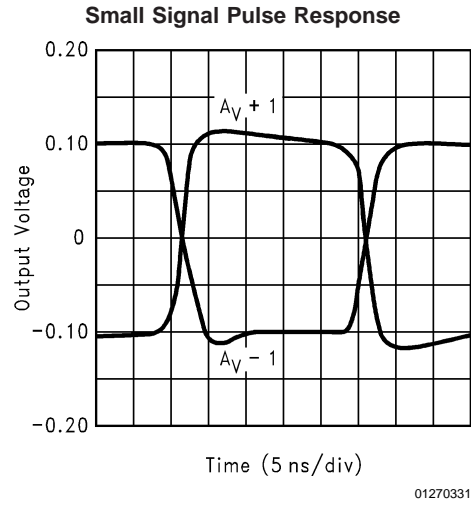
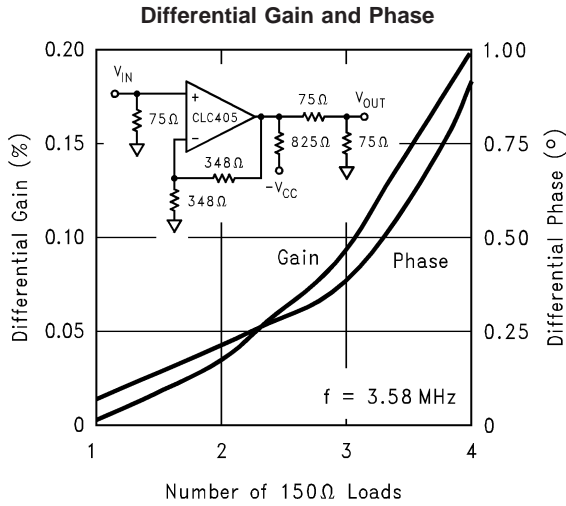

Typical Performance Characteristics ($A_V = +2$, $R_f = 348\Omega$; $V_{CC} = \pm 5V$, $R_L = 100\Omega$ Unless Specified). (Continued)

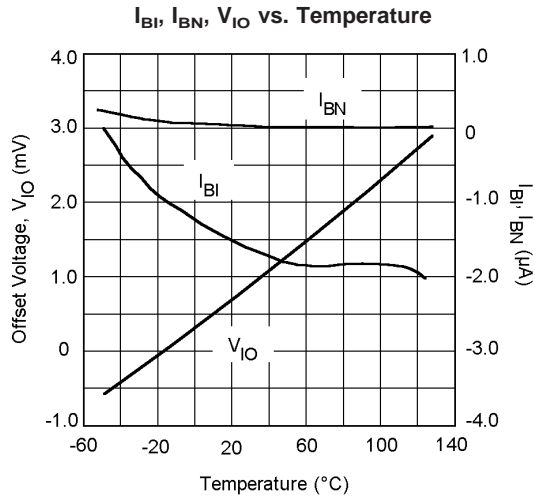

01270327

Application Division

Feedback Resistor

The feedback resistor, R_f , determines the loop gain and frequency response for a current feedback amplifier. Unless otherwise stated, the performance plots and data sheet specify CLC405 operation with R_f of 348Ω at a gain of $+2V/V$. Optimize frequency response for different gains by changing R_f . Decrease to peak frequency response and extend bandwidth. Increase R_f to roll off the frequency response and decrease bandwidth. Use a $2k\Omega$ R_f for unity gain, voltage follower circuits.

Use application note OA-13 to optimize your R_f selection. The equations in this note are a good starting point for selecting R_f . The value for the inverting input impedance for OA-13 is approximately 182Ω .

Enable/Disable Operation Using $\pm 5V$ Supplies

The CLC405 has a TTL & CMOS logic compatible disable function. Apply a logic low (i.e. $<0.8V$) to pin 8, and the CLC405 is guaranteed disabled across its temperature range. Apply a logic high to pin 8, (i.e. $>2.0V$) and the CLC405 is guaranteed enabled. Voltage, not current, at pin 8 determines the enable/disable state of the CLC405.

Disable the CLC405 and its inputs and output become high impedances. While, disabled, the CLC405's quiescent power drops to $8mW$.

Use the CLC405's disable to create analog switches or multiplexers. Implement a single analog switch with one CLC405 positioned between an input and output. Create an analog multiplexer with several CLC405s. Tie the outputs together and put a different signal on each CLC405 input.

Operate the CLC405 without connecting pin 8. An internal $20k\Omega$ pull-up resistor guarantees the CLC405 is enabled when pin 8 is floating.

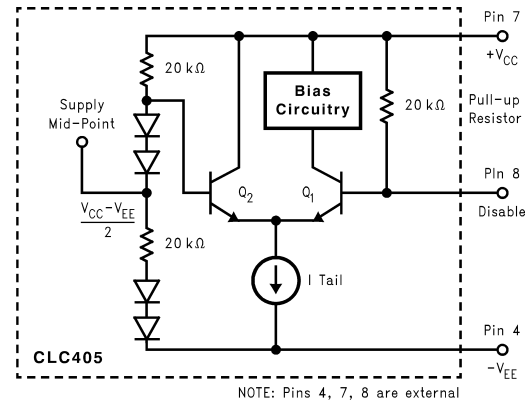

01270320

FIGURE 1. Enable/Disable Operation for Single or Unbalanced Supply Operation

Figure 1 illustrates the internal enable/disable operation of the CLC405. When pin 8 is left floating or is tied to $+V_{CC}$, Q_1 is on and pulls tail current through the CLC405 bias circuitry. When pin 8 is less than $0.8V$ above the supply midpoint, Q_1 stops tail current from flowing in the CLC405 circuitry. The CLC405 is now disabled.

Disable Limitations

The feedback resistor, R_f , limits off isolation in inverting gain configurations. Do not apply voltages greater than $+V_{CC}$ or less than $-V_{EE}$ to pin 8 or any other pin.

Input - Bias Current, Impedance, and Source Termination Considerations

The CLC405 has:

- a $6M\Omega$ non-inverting input impedance.
- a $100nA$ non-inverting input bias current.

If a large source impedance application is considered, remove all parasitic capacitance around the non-inverting input source traces. Parasitic capacitances near the input and source act as a low-pass filter and reduce bandwidth.

Application Division (Continued)

Current feedback op amps have uncorrelated input bias currents. These uncorrelated bias currents prevent source impedance matching on each input from canceling offsets. Refer to application note OA-07 of the data book to find specific circuits to correct DC offsets.

Layout Considerations

Whenever questions about layout arise, USE THE EVALUATION BOARD AS A TEMPLATE.

Use the CLC730013 and CLC730027 evaluation boards for the DIP and SOIC respectively. These board layouts were optimized to produce the typical performance of the CLC405 shown in the data sheet. To reduce parasitic capacitances, the ground plane was removed near pins 2,3, and 6. To reduce series inductance, trace lengths of components and nodes were minimized.

Parasitics on traces degrade performance. Minimize coupling from traces to both power and ground planes. Use low inductive resistors for leaded components.

Do not use dip sockets for the CLC405 DIP amplifiers. These sockets can peak the frequency domain response or create overshoot in the time domain response. Use flush-mount socket pins when socketing is necessary. The 730013 circuit board device holes are sized for Cambion P/N 450-2598 socket pins or their functional equivalent.

Insert the back matching resistor (R_{OUT}) shown in *Figure 2* when driving coaxial cable or a capacitive load. Use the plot in the typical performance section labeled "Settling Time vs. Capacitive Load" to determine the optimum resistor value for R_{OUT} for different capacitive loads. This optimal resistance improves settling time for pulse-type applications and increases stability.

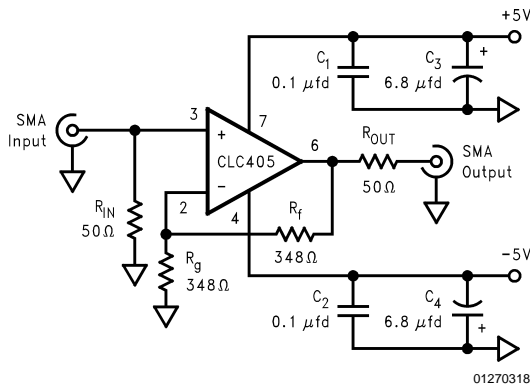
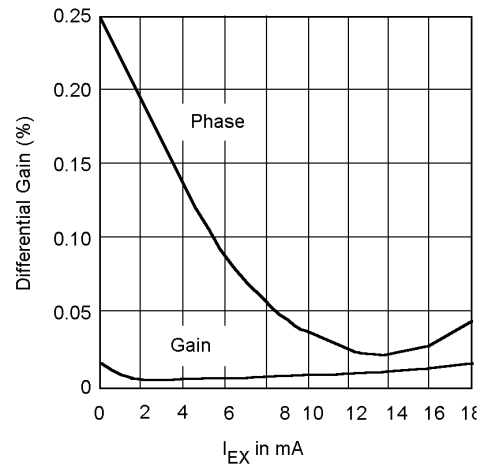

FIGURE 2.

Use power-supply bypassing capacitors when operating this amplifier. Choose quality 0.1 μ F ceramics for C_1 and C_2 . Choose quality 6.8 μ F tantalum capacitors for C_3 and C_4 . Place 0.1 μ F capacitors within 0.1 inches from the power pins. Place the 6.8 μ F capacitors within 3/4 inches from the power pins.

Video Performance vs. I_{EX}

Improve the video performance of the CLC405 by drawing extra current from the amplifier output stage. Using a single external resistor as shown in *Figure 3*, you can adjust the differential phase. Video performance vs. I_{EX} is illustrated below in Graph 1. This graph represents positive video performance with negative synchronization pulses.



Graph 1. Differential Gain & Phase vs. I_{EX}

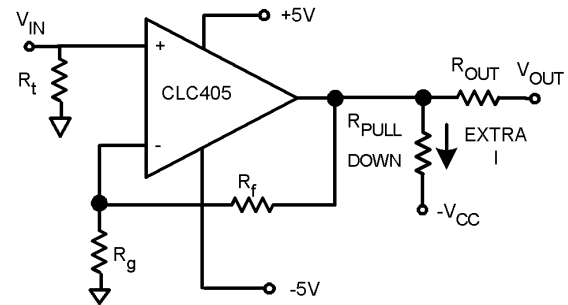

FIGURE 3.

The value for R_{pd} in *Figure 3* is determined by:

$$R_{PD} = \frac{5}{I_{EX}}$$

at $\pm 5V$ supplies.

Wideband Digital PGA

As shown on the front page, the CLC405 is easily configured as a digitally controlled programmable gain amplifier. Make a PGA by configuring several amplifiers at required gains. Keep R_f near 348 Ω and change R_g for each different gain. Use a TTL decoder that has enough outputs to control the selection of different gains and the buffer stage. Connect the buffer stage like the buffer on the front page. The buffer isolates each gain stage from the load and can produce a gain of zero for a gain selection of zero. Use of an inverter (7404) on the buffer disable pin to keep the buffer operational at all gains except zero. Or float the buffer disable pin for a continuous enable state.

Amplitude Equalization

Sending signals over coaxial cable greater than 50 meters in length will attenuate high frequency signal components. Equalizers restore the attenuated components of this signal. The circuit in *Figure 4*, is an op amp equalizer. The RC networks peak the response of the CLC405 at higher fre-

Application Division (Continued)

quencies. This peaking restores cable-attenuated frequencies. Graph 2 shows how the equalizer actually restores a digital word through 150 meters of coaxial cable.

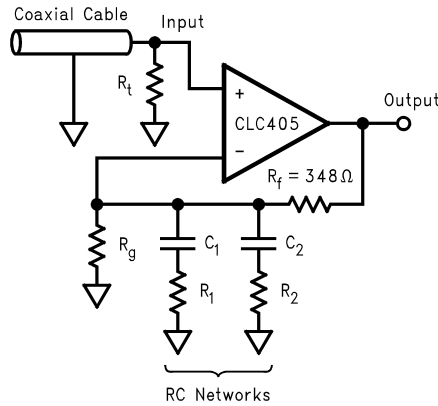

01270321

FIGURE 4.

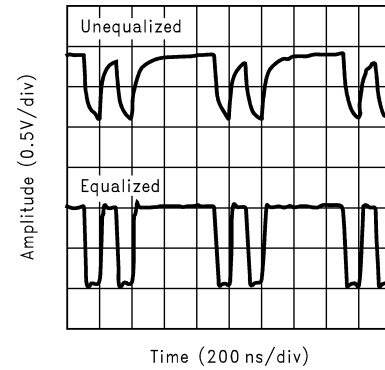

01270330

Graph 2. Digital Word Amplitude Equalization

The values used to produce Graph 2 are:

- $R_g = 348\Omega$
- $R_1 = 450\Omega$
- $C_1 = 470\text{pF}$
- $R_2 = 90\Omega$
- $C_2 = 70\text{pF}$

Amplitude Equalizer

Place the first zero (f_{z1}) at some low frequency (540 khz for Graph 2). R_1 & C_1 produce a pole (f_{p1} @ 750khz) that cancels f_{z1} . Place a second zero at a higher frequency (f_{z2} @ 12Mhz). R_2 & C_2 provide a canceling pole (of $f_{p2} = 25\text{Mhz}$). Graph 3 shows the closed loop response of the op amp equalizer with equations for the poles, zeros, and gains.

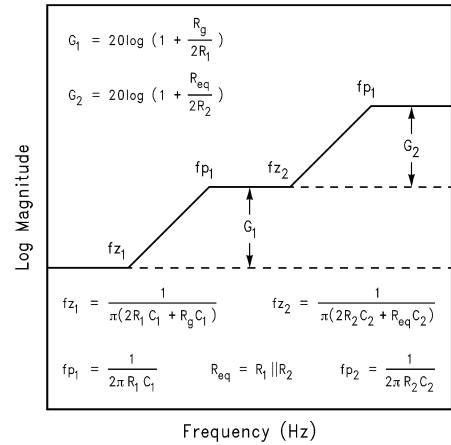

01270322

Graph 3. Closed Loop Equalizer Frequency Response

Note: For very high frequency equalization, us a higher bandwidth part (i.e., CLC44X).

Physical Dimensions inches (millimeters)

unless otherwise noted

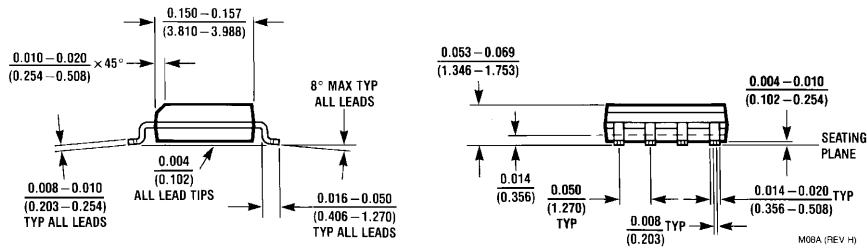
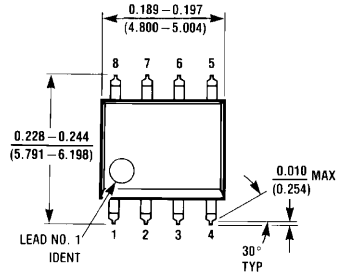

8-Pin SOIC
NS Product Number M08A

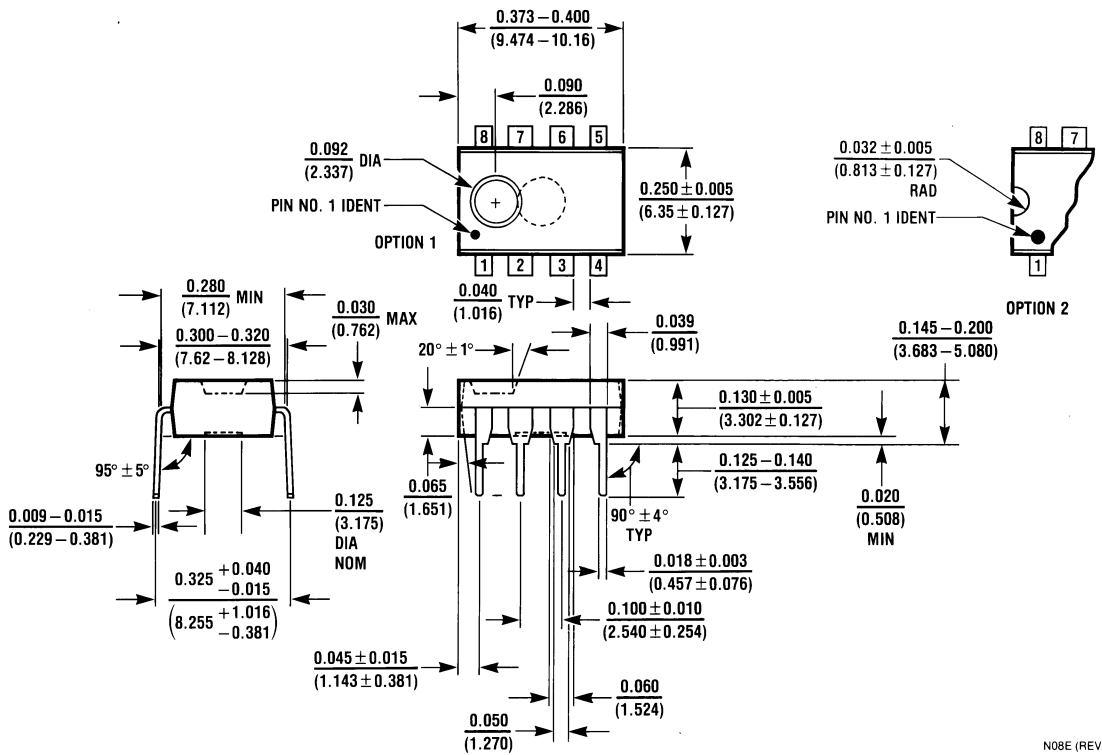

8-Pin MDIP
NS Product Number N08E

Notes

LIFE SUPPORT POLICY

NATIONAL'S PRODUCTS ARE NOT AUTHORIZED FOR USE AS CRITICAL COMPONENTS IN LIFE SUPPORT DEVICES OR SYSTEMS WITHOUT THE EXPRESS WRITTEN APPROVAL OF THE PRESIDENT AND GENERAL COUNSEL OF NATIONAL SEMICONDUCTOR CORPORATION. As used herein:

1. Life support devices or systems are devices or systems which, (a) are intended for surgical implant into the body, or (b) support or sustain life, and whose failure to perform when properly used in accordance with instructions for use provided in the labeling, can be reasonably expected to result in a significant injury to the user.
2. A critical component is any component of a life support device or system whose failure to perform can be reasonably expected to cause the failure of the life support device or system, or to affect its safety or effectiveness.



National Semiconductor Corporation
Americas
Email: support@nsc.com

www.national.com

National Semiconductor Europe

Fax: +49 (0) 180-530 85 86
Email: europe.support@nsc.com
Deutsch Tel: +49 (0) 69 9508 6208
English Tel: +44 (0) 870 24 0 2171
Français Tel: +33 (0) 1 41 91 8790

National Semiconductor Asia Pacific Customer Response Group

Tel: 65-2544466
Fax: 65-2504466
Email: ap.support@nsc.com

National Semiconductor Japan Ltd.

Tel: 81-3-5639-7560
Fax: 81-3-5639-7507