

## **Rochester Electronics Manufactured Components**

Rochester branded components are manufactured using either die/wafers purchased from the original suppliers or Rochester wafers recreated from the original IP. All recreations are done with the approval of the OCM.

Parts are tested using original factory test programs or Rochester developed test solutions to guarantee product meets or exceed the OCM data sheet.

## **Quality Overview**

- ISO-9001
- AS9120 certification
- Qualified Manufacturers List (QML) MIL-PRF-35835
  - Class Q Military
  - Class V Space Level
- Qualified Suppliers List of Distributors (QSLD)
  - Rochester is a critical supplier to DLA and meets all industry and DLA standards.

Rochester Electronics, LLC is committed to supplying products that satisfy customer expectations for quality and are equal to those originally supplied by industry manufacturers.

The original manufacturer's datasheet accompanying this document reflects the performance and specifications of the Rochester manufactured version of this device. Rochester Electronics guarantees the performance of its semiconductor products to the original OEM specifications. 'Typical' values are for reference purposes only. Certain minimum or maximum ratings may be based on product characterization, design, simulation, or sample testing.

March 1997

## 2K x 8 Asynchronous CMOS Static RAM

### Features

- Fast Access Time..... 70/90ns Max
- Low Standby Current..... 50µA Max
- Low Operating Current..... 70mA Max
- Data Retention at 2.0V..... 20µA Max
- TTL Compatible Inputs and Outputs
- JEDEC Approved Pinout (2716, 6116 Type)
- No Clocks or Strokes Required
- Equal Cycle and Access Time
- Single 5V Supply
- Gated Inputs
- No Pull-Up or Pull-Down Resistors Required

### Description

The HM-65162 is a CMOS 2048 x 8 Static Random Access Memory manufactured using the Harris Advanced SAJI V process. The device utilizes asynchronous circuit design for fast cycle time and ease of use. The pinout is the JEDEC 24 pin DIP, and 32 pad 8-bit wide standard which allows easy memory board layouts flexible to accommodate a variety of industry standard PROMs, RAMs, ROMs and EPROMs. The HM-65162 is ideally suited for use in microprocessor based systems with its 8-bit word length organization. The convenient output enable also simplifies the bus interface by allowing the data outputs to be controlled independent of the chip enable. Gated inputs lower operating current and also eliminate the need for pull-up or pull-down resistors.

### Ordering Information

PACKAGE	TEMP. RANGE	70ns/20µA (NOTE 1)	90ns/40µA (NOTE 1)	90ns/300µA (NOTE 1)	PKG. NO.
CERDIP	-40°C to +85°C	HM1-65162B-9	HM1-65162-9	HM1-65162C-9	F24.6
JAN#	-55°C to +125°C	29110BJA	29104BJA	-	F24.6
SMD#	-55°C to +125°C	8403606JA	8403602JA	8403603JA	F24.6
CLCC	-40°C to +85°C	HM4-65162B-9	HM4-65162-9	HM4-65162C-9	J32.A
SMD#	-55°C to 125°C	8403606ZA	8403602ZA	8403603ZA	J32.A

NOTE:

1. Access time/data retention supply current.

### Pinouts

HM-65162  
(CERDIP)  
TOP VIEW

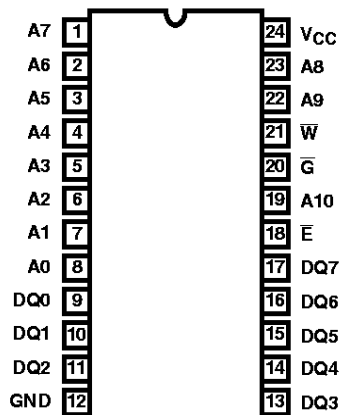

HM-65162  
(CLCC)  
TOP VIEW

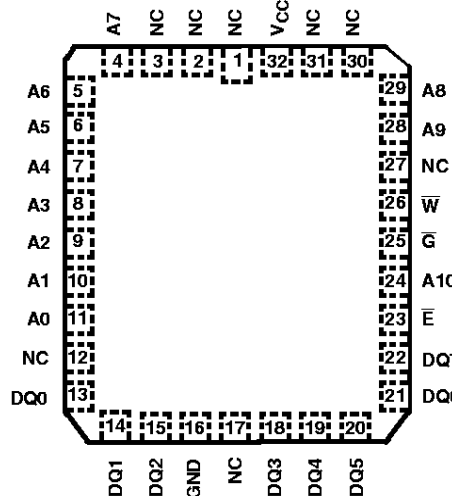

PIN	DESCRIPTION
NC	No Connect
A0 - A10	Address Input
$\bar{E}$	Chip Enable/Power Down
V <sub>SS</sub> /GND	Ground
DQ0 - DQ7	Data In/Data Out
V <sub>CC</sub>	Power (+5V)
$\bar{W}$	Write Enable
$\bar{G}$	Output Enable

Functional Diagram

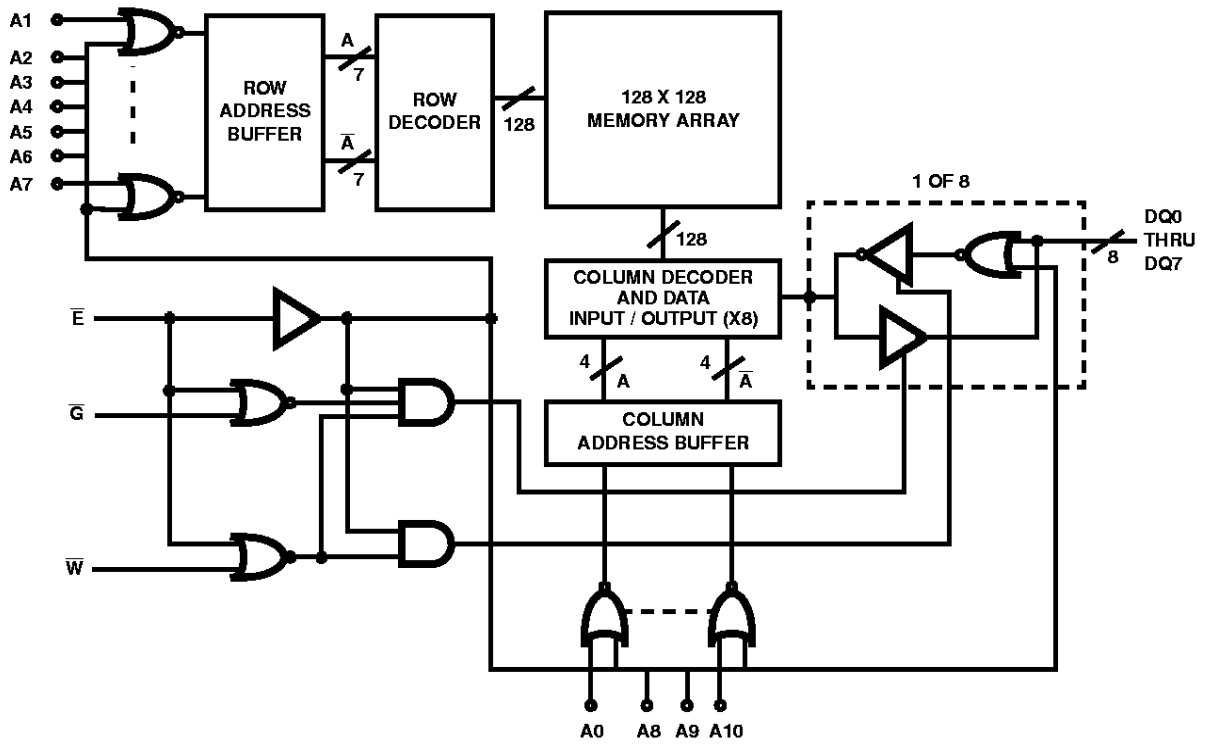

# HM-65162

## Absolute Maximum Ratings

Supply Voltage ..... +7.0V  
 Input, Output or I/O Voltage ..... GND -0.3V to  $V_{CC} + 0.3V$   
 Typical Derating Factor ..... 0.05mA/MHz Increase in ICCOP  
 ESD Classification ..... Class 1

## Operating Conditions

Operating Voltage Range ..... +4.5V to +5.5V  
 Operating Temperature Range  
 HM-65162S-9, HM-65162B-9,  
 HM-65162-9, HM65162C-9 ..... -40°C to +85°C

## Thermal Information

Thermal Resistance	$\theta_{JA}$ (°C/W)	$\theta_{JC}$ (°C/W)
CERDIP Package	48	8
CLCC Package	66	12
Maximum Storage Temperature Range	-65°C to +150°C	
Maximum Junction Temperature	+175°C	
Maximum Lead Temperature (Soldering 10s)	+300°C	

## Die Characteristics

Gate Count ..... 26000 Gates

*CAUTION: Stresses above those listed in "Absolute Maximum Ratings" may cause permanent damage to the device. This is a stress only rating and operation of the device at these or any other conditions above those indicated in the operational sections of this specification is not implied.*

## DC Electrical Specifications $V_{CC} = 5V \pm 10\%$ ; $T_A = -40^\circ C$ to $+85^\circ C$ (HM-65162S-9, HM-65162B-9, HM-65162-9, HM-65162C-9)

SYMBOL	PARAMETER	LIMITS		UNITS	TEST CONDITIONS
		MIN	MAX		
ICCSB1	Standby Supply Current	-	50	$\mu A$	HM-65162B-9, IO = 0mA, $\bar{E} = V_{CC} - 0.3V$ , $V_{CC} = 5.5V$
		-	100	$\mu A$	HM-65162S-9, HM65162-9, IO = 0mA, $\bar{E} = V_{CC} - 0.3V$ , $V_{CC} = 5.5V$
		-	900	$\mu A$	HM-65162C-9, IO = 0mA, $\bar{E} = V_{CC} - 0.3V$ , $V_{CC} = 5.5V$
ICCSB	Standby Supply Current	-	8	mA	$\bar{E} = 2.2V$ , IO = 0mA, $V_{CC} = 5.5V$
ICCEN	Enabled Supply Current	-	70	mA	$\bar{E} = 0.8V$ , IO = 0mA, $V_{CC} = 5.5V$
ICCOP	Operating Supply Current (Note 1)	-	70	mA	$\bar{E} = 0.8V$ , IO = 0mA, f = 1MHz, $V_{CC} = 5.5V$
ICCDR	Data Retention Supply Current	-	20	$\mu A$	HM-65162B-9, IO = 0mA, $V_{CC} = 2.0V$ , $\bar{E} = V_{CC} - 0.3V$
		-	40	$\mu A$	HM-65162S-9, HM-65162-9, IO = 0mA, $V_{CC} = 2.0V$ , $\bar{E} = V_{CC} - 0.3V$
		-	300	$\mu A$	HM-65162C-9, IO = 0mA, $V_{CC} = 2.0V$ , $\bar{E} = V_{CC} - 0.3V$
VCCDR	Data Retention Supply Voltage	2.0	-	V	
II	Input Leakage Current	-1.0	+1.0	$\mu A$	$V_I = V_{CC}$ or GND, $V_{CC} = 5.5V$
IIOZ	Input/Output Leakage Current	-1.0	+1.0	$\mu A$	$V_{IO} = V_{CC}$ or GND, $V_{CC} = 5.5V$
$V_{IL}$	Input Low Voltage	-0.3	0.8	V	$V_{CC} = 4.5V$
$V_{IH}$	Input High Voltage	2.2	$V_{CC} + 0.3$	V	$V_{CC} = 5.5V$
VOL	Output Low Voltage	-	0.4	V	IO = 4.0mA, $V_{CC} = 4.5V$
VOH1	Output High Voltage	2.4	-	V	IO = -1.0mA, $V_{CC} = 4.5V$
VOH2	Output High Voltage (Note 2)	$V_{CC} - 0.4$	-	V	IO = -100 $\mu A$ , $V_{CC} = 4.5V$

## Capacitance $T_A = +25^\circ C$

SYMBOL	PARAMETER	MAX	UNITS	TEST CONDITIONS
CI	Input Capacitance (Note 2)	10	pF	f = 1MHz, All measurements are referenced to device GND
CIO	Input/Output Capacitance (Note 2)	12	pF	

### NOTES:

1. Typical derating 5mA/MHz increase in ICCOP.
2. Tested at initial design and after major design changes.

## HM-65162

### AC Electrical Specifications $V_{CC} = 5V \pm 10\%$ , $T_A = -40^{\circ}C$ to $+85^{\circ}C$ (HM-65162S-9, HM-65162B-9, HM65162-9, HM-65162C-9)

SYMBOL	PARAMETER	LIMITS								UNITS	CONDITIONS
		HM-65162S-9		HM-65162B-9		HM-65162-9		HM-65162C-9			
		MIN	MAX	MIN	MAX	MIN	MAX	MIN	MAX		
<b>READ CYCLE</b>											
(1) TAVAX	Read Cycle Time	55	-	70	-	90	-	90	-	ns	(Notes 1, 3)
(2) TAVQV	Address Access Time	-	55	-	70	-	90	-	90	ns	(Notes 1, 3, 4)
(3) TELQV	Chip Enable Access Time	-	55	-	70	-	90	-	90	ns	(Notes 1, 3)
(4) TELQX	Chip Enable Output Enable Time	5	-	5	-	5	-	5	-	ns	(Notes 2, 3)
(5) TGLQV	Output Enable Access Time	-	35	-	50	-	65	-	65	ns	(Notes 1, 3)
(6) TGLQX	Output Enable Output Enable Time	5	-	5	-	5	-	5	-	ns	(Notes 2, 3)
(7) TEHQZ	Chip Enable Output Disable Time	-	35	-	35	-	50	-	50	ns	(Notes 2, 3)
(8) TGHQZ	Output Enable Output Disable Time	-	30	-	35	-	40	-	40	ns	(Notes 2, 3)
(9) TAVQX	Output Hold From Address Change	5	-	5	-	5	-	5	-	ns	(Notes 1, 3)
<b>WRITE CYCLE</b>											
(10) TAVAX	Write Cycle Time	55	-	70	-	90	-	90	-	ns	(Notes 1, 3)
(11) TELWH	Chip Selection to End of Write	45	-	45	-	55	-	55	-	ns	(Notes 1, 3)
(12) TAVWL	Address Setup Time	5	-	10	-	10	-	10	-	ns	(Notes 1, 3)
(13) TWLWH	Write Enable Pulse Width	40	-	40	-	55	-	55	-	ns	(Notes 1, 3)
(14) TWHAX	Write Enable Read Setup Time	10	-	10	-	10	-	10	-	ns	(Notes 1, 3)
(15) TGHQZ	Output Enable Output Disable Time	-	30	-	35	-	40	-	40	ns	(Notes 2, 3)
(16) TWLQZ	Write Enable Output Disable Time	-	30	-	40	-	50	-	50	ns	(Notes 2, 3)
(17) TDVWH	Data Setup Time	25	-	30	-	30	-	30	-	ns	(Notes 1, 3)
(18) TWHDX	Data Hold Time	10	-	10	-	15	-	15	-	ns	(Notes 1, 3)
(19) TWHQX	Write Enable Output Enable Time	0	-	0	-	0	-	0	-	ns	(Notes 1, 3)
(20) TWLEH	Write Enable Pulse Setup Time	45	-	40	-	55	-	55	-	ns	(Notes 1, 3)
(21) TDVEH	Chip Enable Data Setup Time	25	-	30	-	30	-	30	-	ns	(Notes 1, 3)
(22) TAVWH	Address Valid to End of Write	45	-	50	-	65	-	65	-	ns	(Notes 1, 3)

**NOTES:**

1. Input pulse levels: 0 to 3.0V; Input rise and fall times: 5ns (max); Input and output timing reference level: 1.5V; Output load: 1 TTL gate equivalent and  $C_L = 50pF$  (min) - for  $C_L$  greater than 50pF, access time is derated by 0.15ns per pF.
2. Tested at initial design and after major design changes.
3.  $V_{CC} = 4.5$  and 5.5V.
4. TAVQV = TELQV + TAVEL.

Timing Waveforms

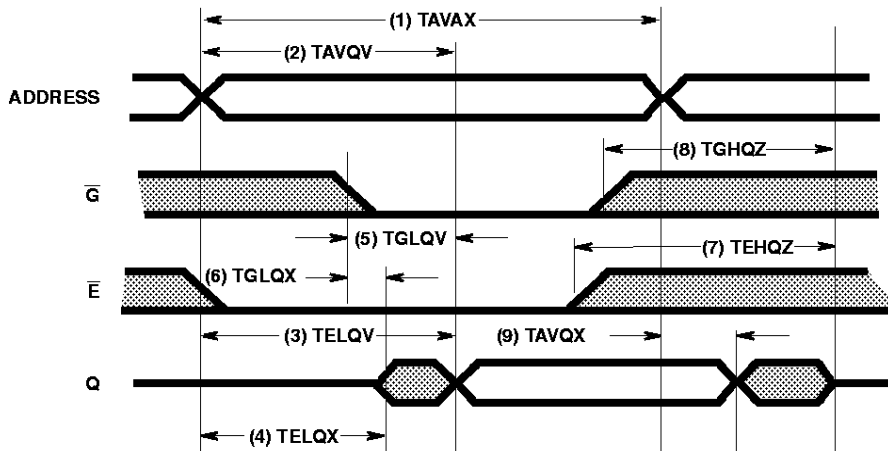

NOTE:

1.  $\bar{W}$  is high for a Read Cycle.

FIGURE 1. READ CYCLE

Addresses must remain stable for the duration of the read cycle. To read,  $\bar{G}$  and  $\bar{E}$  must be  $\leq V_{IL}$  and  $\bar{W} \geq V_{IH}$ . The output buffers can be controlled independently by  $\bar{G}$  while  $\bar{E}$  is low. To execute consecutive read cycles,  $\bar{E}$  may be tied

low continuously until all desired locations are accessed. When  $\bar{E}$  is low, addresses must be driven by stable logic levels and must not be in the high impedance state.

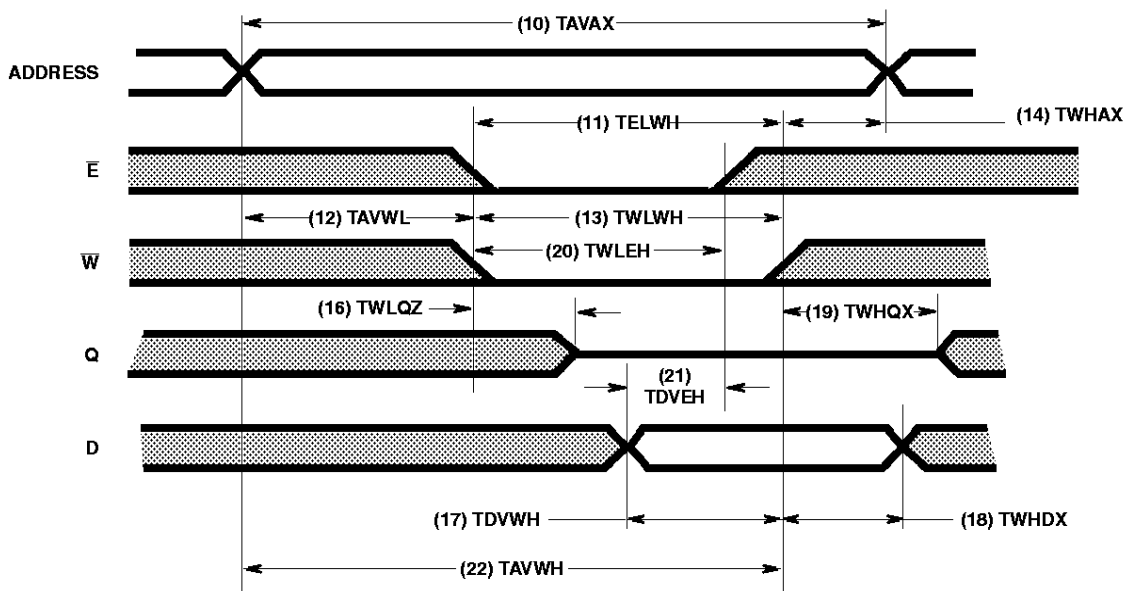

NOTE:

1.  $\bar{G}$  is low throughout Write Cycle.

FIGURE 2. WRITE CYCLE I

To write, addresses must be stable,  $\bar{E}$  low and  $\bar{W}$  falling low for a period no shorter than TWLWH. Data in is referenced with the rising edge of  $\bar{W}$ , (TDVWH and TWHDX). While addresses are changing,  $\bar{W}$  must be high. When  $\bar{W}$  falls low, the I/O pins are still in the output state for a period of TWLQZ

and input data of the opposite phase to the outputs must not be applied, (Bus contention). If  $\bar{E}$  transitions low simultaneously with the  $\bar{W}$  line transitioning low, or after the  $\bar{W}$  transition, the output will remain in a high impedance state.  $\bar{G}$  is held continuously low.

**Timing Waveforms (Continued)**

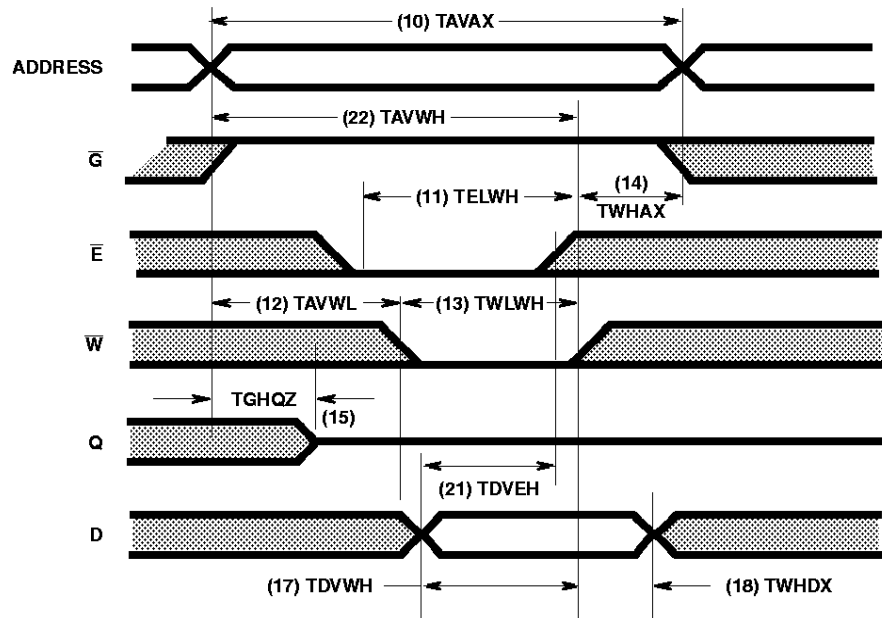

FIGURE 3. WRITE CYCLE II

In this write cycle  $\bar{G}$  has control of the output after a period, TGHQZ.  $\bar{G}$  switching the output to a high impedance state allows data in to be applied without bus contention after

TGHQZ. When  $\bar{W}$  transitions high, the data in can change after TWHDX to complete the write cycle.

**Low Voltage Data Retention**

Harris CMOS RAMs are designed with battery backup in mind. Data retention voltage and supply current are guaranteed over temperature. The following rules ensure data retention:

1. Chip Enable ( $\bar{E}$ ) must be held high during data retention; within  $V_{CC} - 0.3V$  to  $V_{CC} + 0.3V$ .
2. On RAMs which have selects or output enables (e.g.,  $S_i$ ,  $\bar{G}$ ), one of the selects or output enables should be held in the deselected state to keep the RAM outputs high impedance, minimizing power dissipation.
3. Inputs which are to be held high (e.g.,  $\bar{E}$ ) must be kept between  $V_{CC} + 0.3V$  and 70% of  $V_{CC}$  during the power up and down transitions.
4. The RAM can begin operation > 55ns after  $V_{CC}$  reaches the minimum operating voltage (4.5V).

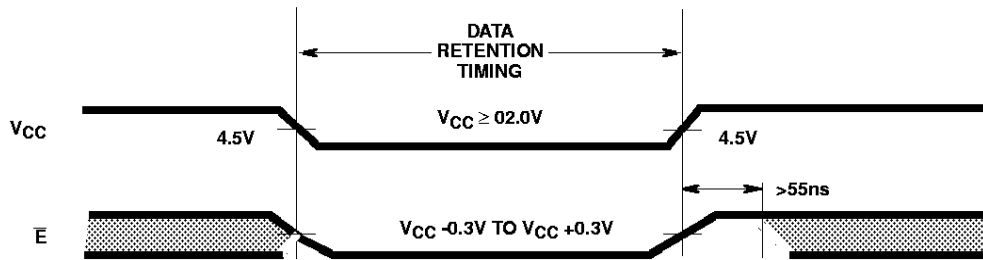

FIGURE 4. DATA RETENTION TIMING

Typical Performance Curve

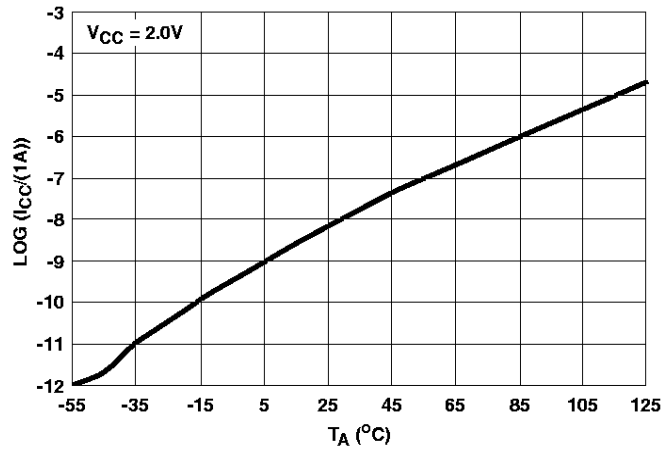

FIGURE 5. TYPICAL ICCDR vs  $T_A$