

# CD4000B, CD4001B, CD4002B, CD4025B Types

## COS/MOS NOR Gates

### Features:

- Propagation delay time = 60 ns (typ.) at  $C_L = 50$  pF,  $V_{DD} = 10$  V
- Buffered inputs and outputs
- Standardized symmetrical output characteristics
- 100% tested for maximum quiescent current at 20 V
- 5-V, 10-V, and 15-V parametric ratings
- Maximum input current of  $1 \mu\text{A}$  at 18 V over full package-temperature range;  $100 \text{ nA}$  at 18 V and  $25^\circ\text{C}$
- Noise margin (over full package temperature range):

1 V at  $V_{DD} = 5$  V  
 2 V at  $V_{DD} = 10$  V  
 2.5 V at  $V_{DD} = 15$  V

- Meets all requirements of JEDEC Tentative Standard No. 13A, "Standard Specifications for Description of "B" Series CMOS Devices"

High-Voltage Types (20-Volt Rating)

Dual 3 Input  
 plus Inverter – CD4000B  
 Quad 2 Input – CD4001B  
 Dual 4 Input – CD4002B  
 Triple 3 Input – CD4025B

RCA-CD4000B, CD4001B, CD4002B, and CD4025B NOR gates provide the system designer with direct implementation of the NOR function and supplement the existing family of COS/MOS gates. All inputs and outputs are buffered.

The CD4000B, CD4001B, CD4002B, and CD4025B types are supplied in 14-lead hermetic dual-in-line ceramic packages (D and F suffixes), 14-lead dual-in-line plastic packages (E suffix), 14-lead ceramic flat packages (K suffix), and in chip form (H suffix).

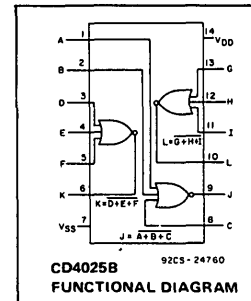
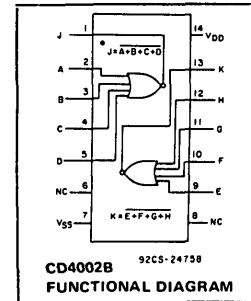
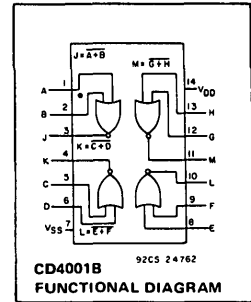
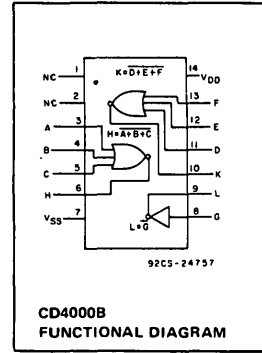

### STATIC ELECTRICAL CHARACTERISTICS

CHARACTERISTIC	CONDITIONS			LIMITS AT INDICATED TEMPERATURES (°C)							UNITS
	V <sub>O</sub> (V)	V <sub>IN</sub> (V)	V <sub>DD</sub> (V)	Values at -55, +25, +125 Apply to D,F,H Packages				Values at -40, +25, +85 Apply to E Package			
				-55	-40	+85	+125	+25			
				Min.	Typ.	Max.					
Quiescent Device Current, I <sub>DD</sub> Max	-	0,5	5	0,25	0,25	7,5	7,5	-	0,01	0,25	μA
	-	0,10	10	0,5	0,5	15	15	-	0,01	0,5	
	-	0,15	15	1	1	30	30	-	0,01	1	
	-	0,20	20	5	5	150	150	-	0,02	5	
Output Low (Sink) Current I <sub>OL</sub> Min	0,4	0,5	5	0,64	0,61	0,42	0,36	0,51	1	-	mA
	0,5	0,10	10	1,6	1,5	1,1	0,9	1,3	2,6	-	
	1,5	0,15	15	4,2	4	2,8	2,4	3,4	6,8	-	
Output High (Source) Current, I <sub>OH</sub> Min	4,6	0,5	5	-0,64	-0,61	-0,42	-0,36	-0,51	-1	-	mA
	2,5	0,5	5	-2	-1,8	-1,3	-1,15	-1,6	-3,2	-	
	9,5	0,10	10	-1,6	-1,5	-1,1	-0,9	-1,3	-2,6	-	
	13,5	0,15	15	-4,2	-4	-2,8	-2,4	-3,4	-6,8	-	
Output Voltage Low-Level, V <sub>OL</sub> Max	-	0,5	5	0,05			-	0	0,05	-	V
	-	0,10	10	0,05			-	0	0,05	-	
	-	0,15	15	0,05			-	0	0,05	-	
Output Voltage High-Level, V <sub>OH</sub> Min	-	0,5	5	4,95			4,95	5	-	-	V
	-	0,10	10	9,95			9,95	10	-	-	
	-	0,15	15	14,95			14,95	15	-	-	
Input Low Voltage, V <sub>IL</sub> Max	0,5, 4,5	-	5	1,5			-	-	1,5	-	V
	1,9	-	10	3			-	-	3	-	
	1,5, 13,5	-	15	4			-	-	4	-	
Input High Voltage, V <sub>IH</sub> Min	0,5	-	5	3,5			3,5	-	-	-	V
	1	-	10	7			7	-	-	-	
	1,5	-	15	11			11	-	-	-	
Input Current I <sub>IN</sub> Max		0,18	18	±0,1	±0,1	±1	±1	-	±10 <sup>-5</sup>	±0,1	μA

# CD4000B, CD4001B, CD4002B, CD4025B Types

## RECOMMENDED OPERATING CONDITIONS

For maximum reliability, nominal operating conditions should be selected so that operation is always within the following ranges:

CHARACTERISTIC	LIMITS		UNITS
	MIN.	MAX.	
Supply-Voltage Range (For $T_A$ = Full Package Temperature Range)	3	18	V

## MAXIMUM RATINGS, Absolute-Maximum Values

DC SUPPLY-VOLTAGE RANGE, ( $V_{DD}$ ) (Voltages referenced to $V_{SS}$ Terminal)	-0.5 to +20 V
INPUT VOLTAGE RANGE, ALL INPUTS	-0.5 to $V_{DD}$ + 0.5 V
DC INPUT CURRENT, ANY ONE INPUT	$\pm 10$ mA
POWER DISSIPATION PER PACKAGE ( $P_D$ )	500 mW
For $T_A = -40$ to $+60^\circ\text{C}$ (PACKAGE TYPE E)	Derate Linearly at 12 mW/ $^\circ\text{C}$ to 200 mW
For $T_A = +60$ to $+85^\circ\text{C}$ (PACKAGE TYPE E)	
For $T_A = -55$ to $+100^\circ\text{C}$ (PACKAGE TYPES D, F)	500 mW
For $T_A = +100$ to $+125^\circ\text{C}$ (PACKAGE TYPES D, F)	Derate Linearly at 12 mW/ $^\circ\text{C}$ to 200 mW
DEVICE DISSIPATION PER OUTPUT TRANSISTOR FOR $T_A$ = FULL PACKAGE TEMPERATURE RANGE (All Package Types)	100 mW
OPERATING-TEMPERATURE RANGE ( $T_A$ )	-55 to $+125^\circ\text{C}$
PACKAGE TYPES D, F, H	-40 to $+85^\circ\text{C}$
PACKAGE TYPE E	-65 to $+150^\circ\text{C}$
STORAGE TEMPERATURE RANGE ( $T_{stg}$ )	-65 to $+150^\circ\text{C}$
LEAD TEMPERATURE (DURING SOLDERING) At distance 1/16 $\pm$ 1/32 inch (1.59 $\pm$ 0.79 mm) from case for 10 s max	$+265^\circ\text{C}$

## DYNAMIC ELECTRICAL CHARACTERISTICS

At  $T_A = 25^\circ\text{C}$ ; Input  $t_r, t_f = 20$  ns,  $C_L = 50$  pF,  $R_L = 200$  k $\Omega$

CHARACTERISTIC	TEST CONDITIONS	ALL TYPES LIMITS		UNITS	
		$V_{DD}$ VOLTS	TYP.		MAX.
Propagation Delay Time, $t_{PHL}, t_{PLH}$		5	125	250	ns
		10	60	120	
		15	45	90	
Transition Time, $t_{THL}, t_{TLH}$		5	100	200	ns
		10	50	100	
		15	40	80	
Input Capacitance, $C_{IN}$	Any Input	5	7.5	pF	

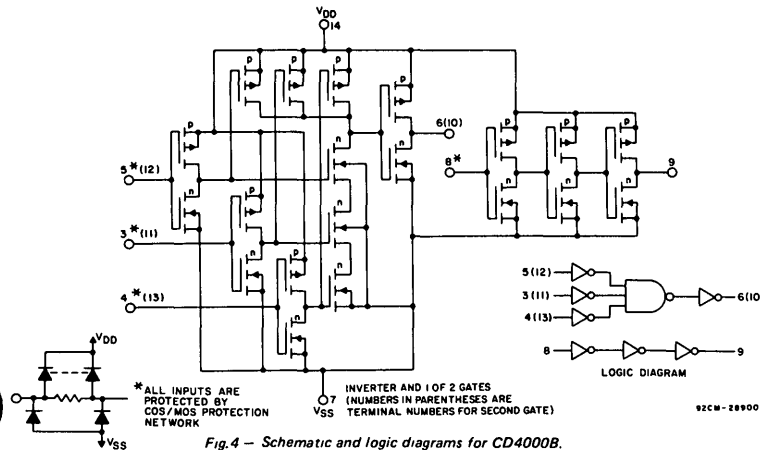

Fig. 4 - Schematic and logic diagrams for CD4000B.

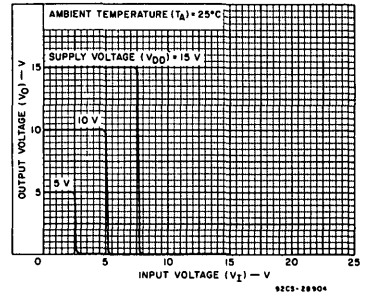

Fig. 1 - Typical voltage transfer characteristics.

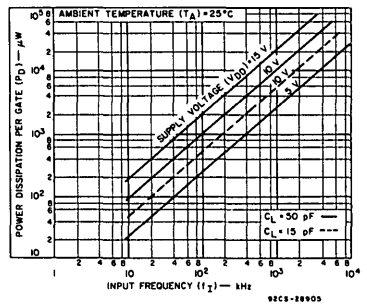

Fig. 2 - Typical power dissipation vs. frequency.

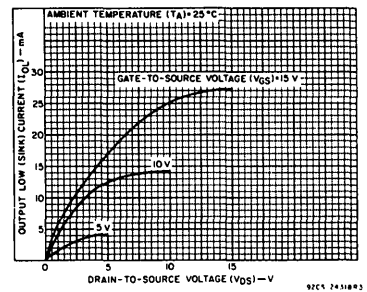

Fig. 3 - Typical output low (sink) current characteristics.

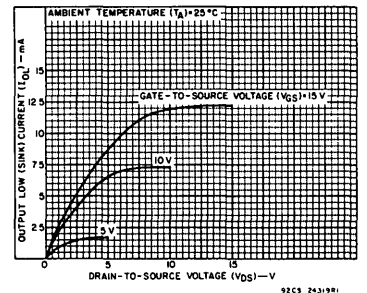

Fig. 5 - Minimum output low (sink) current characteristics

# CD4000B, CD4001B, CD4002B, CD4025B Typ s

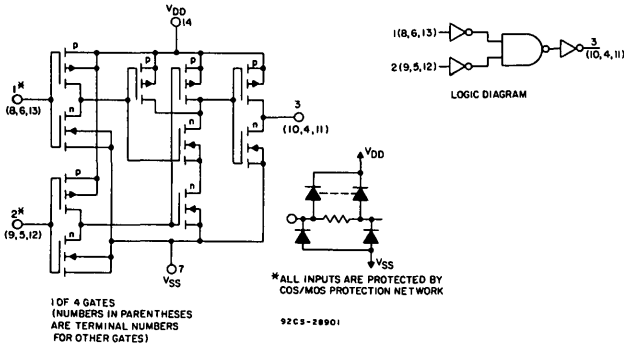

Fig.6 - Schematic and logic diagrams for CD4001B.

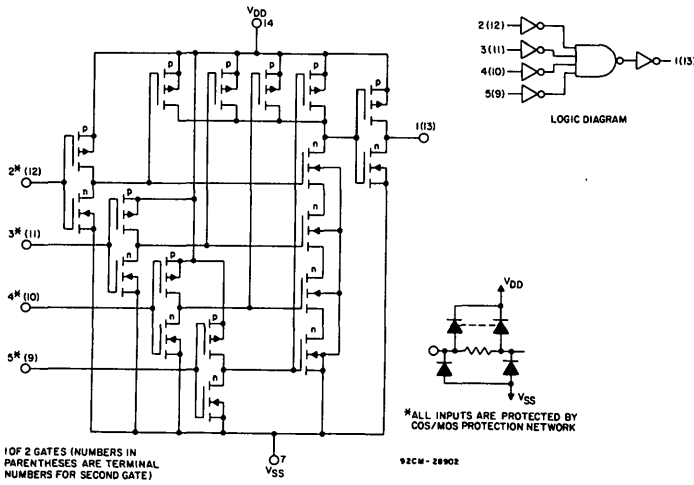

Fig.7 - Schematic and logic diagrams for CD4002B.

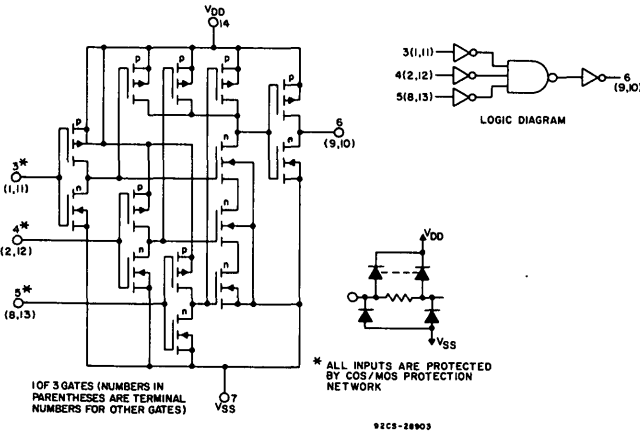

Fig.8 - Schematic and logic diagrams for CD4025B.

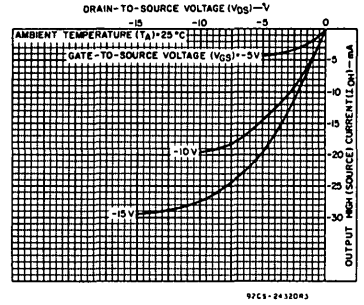

Fig.9 - Typical output high (source) current characteristics.

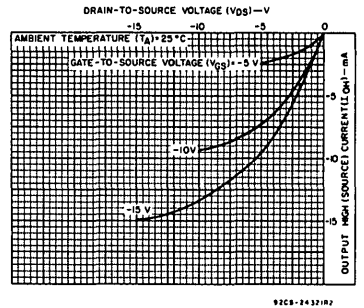

Fig.10 - Minimum output high (source) current characteristics.

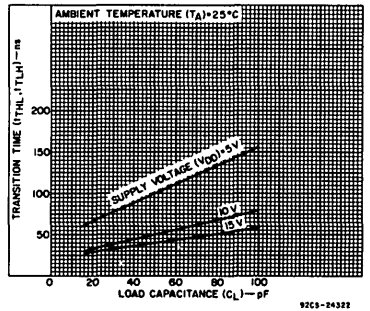

Fig.11 - Typical transition time vs. load capacitance.

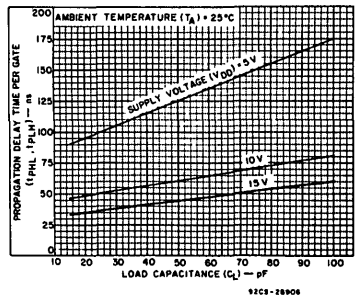

Fig.12 - Typical propagation delay time vs. load capacitance.

# CD4000B, CD4001B, CD4002B, CD4025B Types

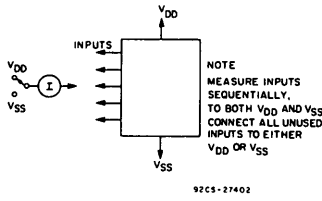

Fig. 13 - Input leakage current test circuit.

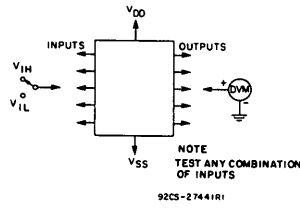

Fig. 14 - Input-voltage test circuit.

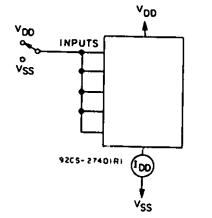
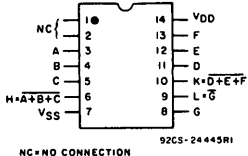
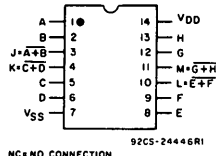

Fig. 15 - Quiescent-device current test circuit.

## TERMINAL ASSIGNMENTS (TOP VIEW)



CD4000B



CD4001B

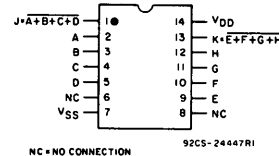

CD4002B

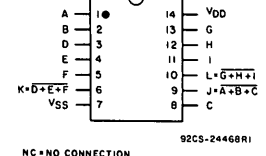

CD4025B

## CHIP PHOTOGRAPHS Dimensions and Pad Layouts

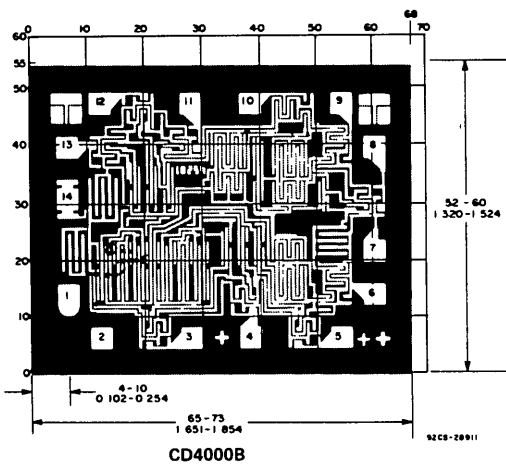

CD4000B

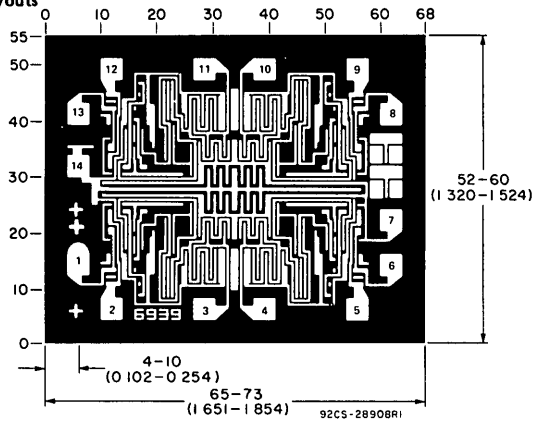

CD4002B

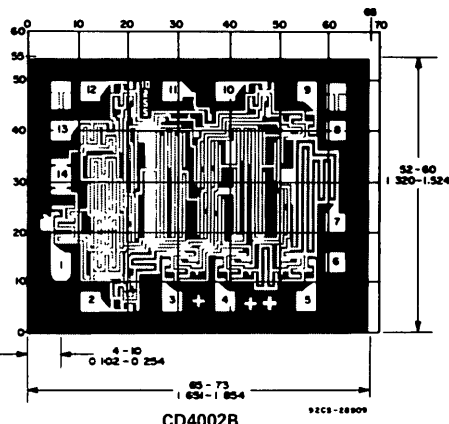

CD4001B

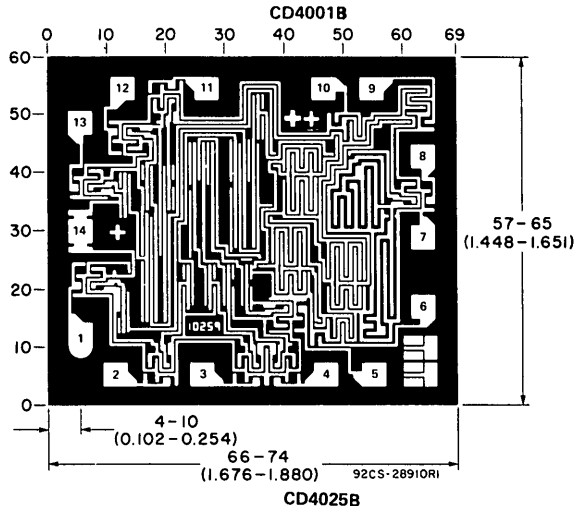

CD4025B