



HARRIS

HA-2720/25

Wide Range Programmable Operational Amplifier

**Not Recommended
For New Designs
See HA-5141 or HA-5151**

Features

- WIDE PROGRAMMING RANGE

SLEW RATE	0.06 TO 6V/ μ s
BANDWIDTH	5kHz TO 10MHz
BIAS CURRENT	0.4 TO 50nA
SUPPLY CURRENT	1 μ A TO 1.5mA
- WIDE POWER SUPPLY RANGE ± 1.2 TO ± 18 V
- CONSTANT AC PERFORMANCE OVER SUPPLY RANGE

Applications

- ACTIVE FILTERS
- CURRENT CONTROLLED OSCILLATORS
- VARIABLE ACTIVE FILTERS
- MODULATORS
- BATTERY-POWERED EQUIPMENT

Description

HA-2720/2725 programmable amplifiers are internally compensated monolithic devices offering a wide range of performance, that can be controlled by adjusting the circuits' "set" current (I_{SET}). By means of adjusting an external resistor or current source, power dissipation, slew rate, bandwidth, output current and input noise can be programmed to desired levels. This versatile adjustment capability enables HA-2720/2725 to provide optimum design solutions by delivering the required level of performance with minimum possible power dissipation. HA-2720 and HA-2725 can, therefore, be utilized as the standard amplifier for a variety of designs simply by adjusting their programming current.

A major advantage of HA-2720/2725 is that operating characteristics remain virtually constant over a wide supply range (± 1.2 V to ± 15 V), allowing the amplifiers to offer maximum performance in almost any system including battery-operated equipment. A primary application for HA-2720/2725 is in active filters for a wide variety of signals that differ in frequency and amplitude. Also, by modulating the "set" current, HA-2720/2725 can be used for designs such as current controlled oscillators modulators, sample and hold circuits and variable active filters.

HA-2720 is guaranteed over -55°C to $+125^{\circ}\text{C}$. HA-2725 is specified from 0°C to $+75^{\circ}\text{C}$. Both parts are available in TO-99 cans or dice form.

Pinouts

HA7-2720/2725 (CERAMIC MINI-DIP)
TOP VIEW

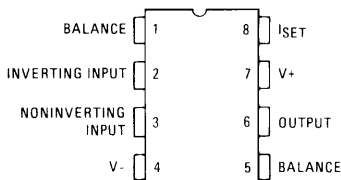

Note: Case tied to V-

HA2-2720/2725 (TO-99 METAL CAN)
TOP VIEW

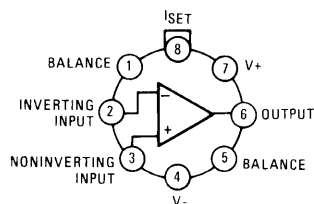

Schematic

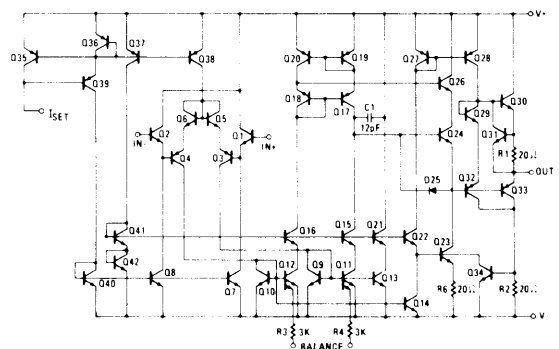

Specifications HA-2720/2725

Absolute Maximum Ratings

Voltage Between V+ and V- Terminals	45V
Differential Input Voltage	±30V
Input Voltage (Note 1)	±15V
I _{SET} (Current at I _{SET})	500µA
V _{SET} (Voltage to GND at I _{SET})	V+ - 2V ≤ V _{SET} ≤ V+
Power Dissipation (Note 2)	300mW

Operating Temperature Ranges

HA-2720	-55°C ≤ T _A ≤ +125°C
HA-2725	0°C ≤ T _A ≤ +75°C
Storage Temperature Range:	-65°C ≤ T _A ≤ +150°C

Electrical Specifications

V+ = +3V, V- = -3V.

PARAMETER	TEMP.	HA-2720 -55°C to +125°C						HA-2725 0°C to +75°C						UNITS
		I _{SET} = 1.5µA			I _{SET} = 15µA			I _{SET} = 1.5µA			I _{SET} = 15µA			
		MIN.	TYP.	MAX.	MIN.	TYP.	MAX.	MIN.	TYP.	MAX.	MIN.	TYP.	MAX.	
INPUT CHARACTERISTICS														
Offset Voltage	25°C Full		2.0	3.0		2.0	3.0		2.0	5.0		2.0	5.0	mV mV
Offset Current	25°C Full		0.5	3.0		1.0	10		0.5	5.0		1.0	10	nA nA
Bias Current	25°C Full		2.0	5.0		8.0	20		2.0	10		8.0	30	nA nA
Input Resistance (Note 10)	25°C		50			5			50			5		MΩ
Input Capacitance	25°C		3.0			3.0			3.0			3.0		pF
TRANSFER CHARACTERISTICS														
Large Signal Voltage Gain (Note 9)	25°C Full	15K	40K		15K	40K		15K	40K		15K	40K		V/V V/V
Common Mode Rejection Ratio (Note 4)	Full	30			80			74			74			dB
OUTPUT CHARACTERISTICS														
Output Voltage Swing (Note 3)	25°C Full	±2.0	±2.2		±2.0	±2.2		±2.0	±2.2		±2.0	±2.2		V V
Output Current (Note 5)	25°C		±0.2			±2.0			±0.2			±2.0		mA
Output Resistance	25°C		2K			500			2K			500		Ω
Output Short-Circuit Current	25°C		2.8			14			2.8			14		mA
TRANSIENT RESPONSE														
Rise Time (Note 6)	25°C		2.5			0.25			2.5			0.25		µs
Overshoot (Note 6)	25°C		5			10			5			10		%
Slew Rate (Note 7)	25°C		0.07			0.70			0.07			0.70		V/µs
POWER SUPPLY CHARACTERISTICS														
Supply Current	25°C Full		15			170			15			170		µA µA
Power Supply Rejection Ratio (Note 8)	Full	80			80			76			76			dB

HA-2720/25

2

OP AMPS & COMPARATORS

Specifications HA-2720/2725

Electrical Specifications (Continued) $V_+ = +15V, V_- = -15V$.

PARAMETER	TEMP.	HA-2720 -55°C to +125°C						HA-2725 0°C to +75°C						UNITS	
		I _{SET} = 1.5μA			I _{SET} = 15μA			I _{SET} = 1.5μA			I _{SET} = 15μA				
		MIN.	TYP.	MAX.	MIN.	TYP.	MAX.	MIN.	TYP.	MAX.	MIN.	TYP.	MAX.		
INPUT CHARACTERISTICS															
Offset Voltage	25°C Full		2.0	3.0		2.0	3.0		2.0	5.0	7.0	2.0	5.0	7.0	mV mV
Offset Current	25°C Full		0.5	3.0		1.0	10		0.5	5.0	7.5	1.0	10	20	nA nA
Bias Current	25°C Full		2.0	5.0		8.0	20		2.0	10	10	8.0	30	40	nA nA
Input Resistance (Note 10)	25°C		50			5			50			5			MΩ
Input Capacitance	25°C		3.0			3.0			3.0			3.0			pF
TRANSFER CHARACTERISTICS															
Large Signal Voltage Gain (Notes 3 & 9)	25°C Full	30K	100K		30K	120K		25K	40K		25K	120K			V/V V/V
Common Mode Rejection Ratio (Note 4)	25°C Full	80	90		80	90		74	90		74	90			dB dB
OUTPUT CHARACTERISTICS															
Output Voltage Swing (Note 3)	25°C Full	±12	±13.5		±12	±13.5		±12	±13.5		±12	±13.5			V V
Output Current (Note 5)	25°C		±0.5			±5.0			±0.5			±5.0			mA
Output Resistance	25°C		2K			500			2K			500			Ω
Output Short-Circuit Current	25°C		3.7			19			3.7			19			mA
TRANSIENT RESPONSE															
Rise Time (Note 6)	25°C		2.0			0.2			2.0			0.2			μs
Overshoot (Note 6)	25°C		5			15			5			15			%
Slew Rate (Note 7)	25°C		0.1			0.8			0.1			0.8			V/μs
POWER SUPPLY CHARACTERISTICS															
Supply Current	25°C Full		20	50		210	450		20	50		210	450		μA μA
Power Supply Rejection Ratio (Note 8)	Full	80			80			76			76				dB

- NOTES 1. For supply voltages less than ±15.0V, the absolute maximum input voltage is equal to supply voltage.
 2. Derate at 6.8mW/°C for operation ambient temperatures above 75°C

$V_{SUPPLY} = \pm 3.0V$	$V_{SUPPLY} = \pm 15.0V$	$I_{SET} = 1.5\mu A$	$I_{SET} = 15\mu A$
3. T = +25°C and Full	T = +25°C	$R_L = 75K\Omega$	$R_L = 5K\Omega$
—	T = Full	$R_L = 75K\Omega$	$R_L = 75K\Omega$
4. $V_{CM} = \pm 1.5V$	$V_{CM} = \pm 5.0V$		
5. $V_O = \pm 2.0V$	$V_O = \pm 10.0V$		
6. $\leftarrow A_V = +1, V_{IN} = 400mV, R_L = 5K, C_L = 100pF \rightarrow$		$R_L = 20K$	$R_L = 5K$
7. $V_O = \pm 2.0V$	$V_O = \pm 10.0V$		
8. $\Delta V = \pm 1.5V$	$\Delta V = \pm 5.0V$		
9. $V_O = \pm 1.0V$	$V_O = \pm 10.0V$		

10. This parameter based upon design calculations.

Typical Performance Curves $T_A = +25^\circ\text{C}$, $V_S = \pm 15\text{V D.C.}$ Unless Otherwise Specified.

INPUT BIAS CURRENT vs. SET CURRENT

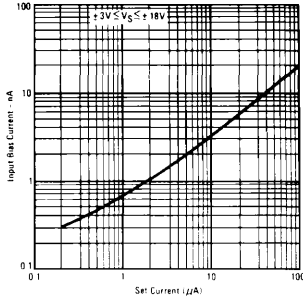

INPUT BIAS CURRENT vs. TEMPERATURE

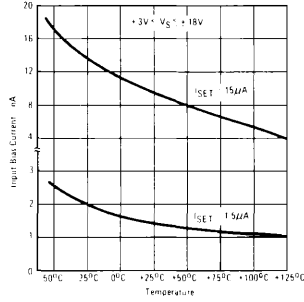

INPUT OFFSET CURRENT vs. TEMPERATURE

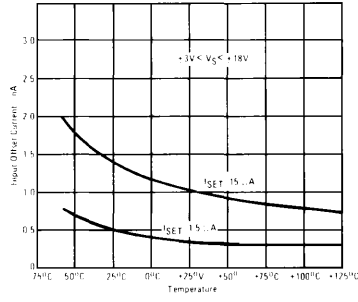

CHANGE IN OFFSET VOLTAGE vs. I_SET (UNNULLED)

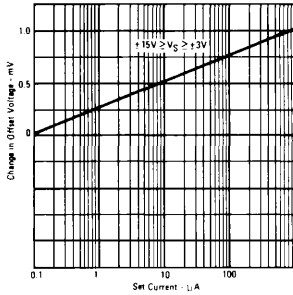

INPUT NOISE CURRENT vs. I_SET

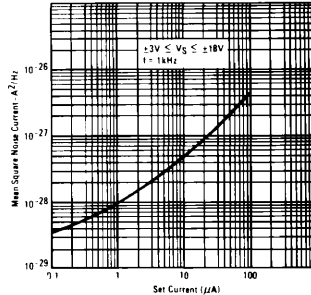

INPUT NOISE VOLTAGE vs. I_SET

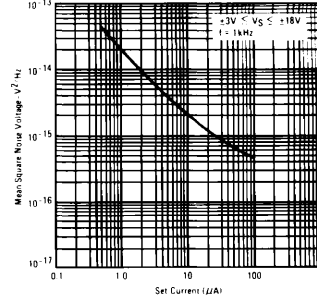

INPUT NOISE VOLTAGE AND CURRENT vs. FREQUENCY

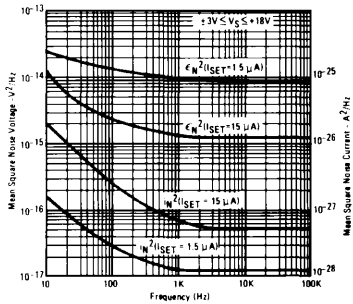

OPTIMUM SET CURRENT FOR MINIMUM NOISE vs. SOURCE RESISTOR

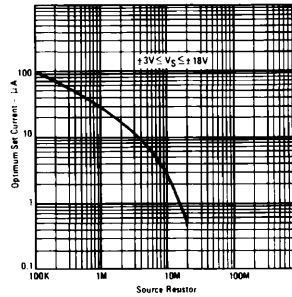

Typical Performance Curves (Continued) $T_A = +25^\circ\text{C}$, $V_S = \pm 15\text{V D.C.}$ Unless Otherwise Specified.

MAXIMUM OUTPUT VOLTAGE SWING vs. LOAD RESISTANCE

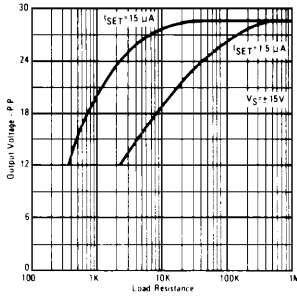

GAIN BANDWIDTH PRODUCT vs. ISET

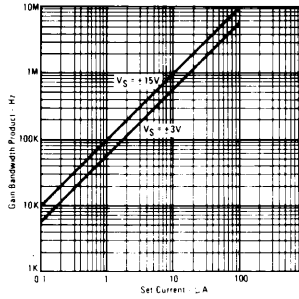

OPEN LOOP VOLTAGE GAIN vs. TEMPERATURE

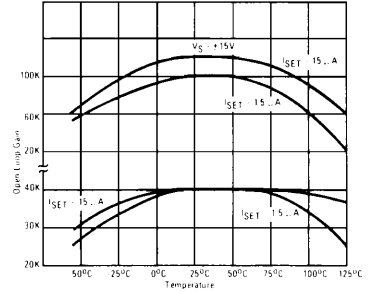

OPEN LOOP VOLTAGE GAIN vs. ISET

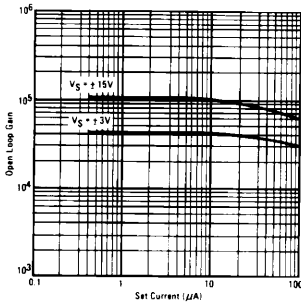

POWER SUPPLY REJECTION vs. ISET

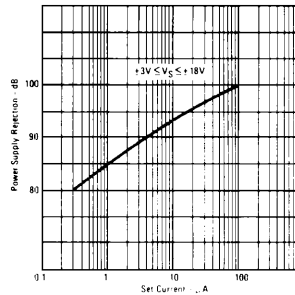

STANDBY SUPPLY CURRENT vs. ISET

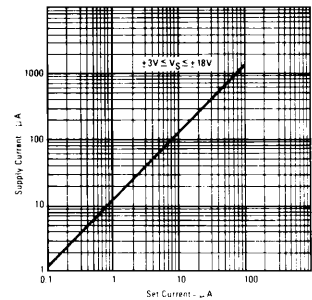

SUPPLY CURRENT vs. TEMPERATURE

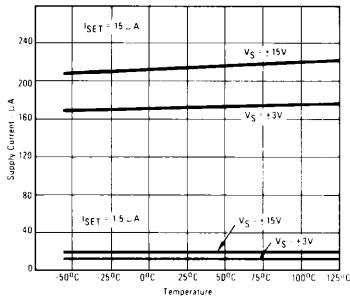

NORMALIZED BANDWIDTH vs. TEMPERATURE

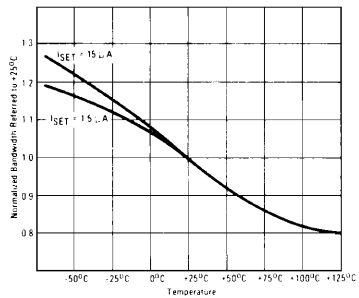

Typical Performance Curves (Continued) $T_A = +25^{\circ}\text{C}$, $V_S = \pm 15\text{V D.C.}$ Unless Otherwise Specified.

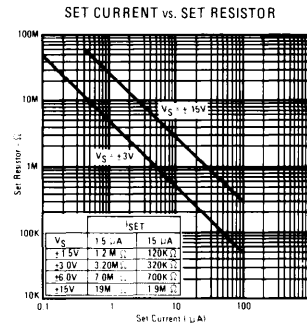
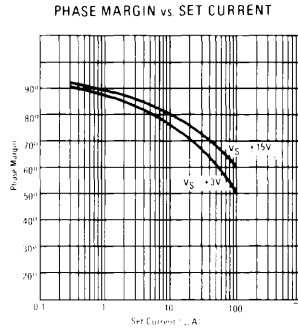
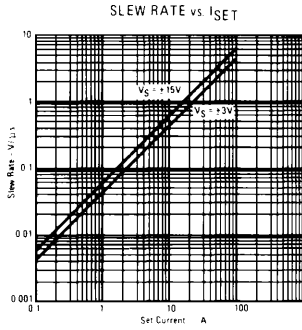

Test Circuits

TYPICAL BIASING CIRCUITS

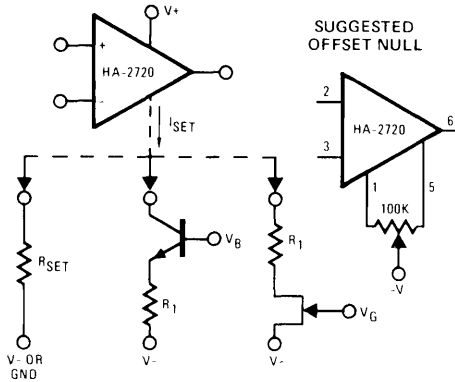

TRANSIENT RESPONSE/SLEW RATE CIRCUIT

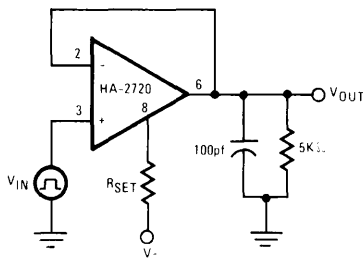

SLEWING WAVEFORM

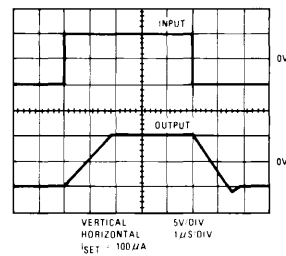

Die Characteristics

Transistor Count	44	
Die Dimensions	60 x 44 x 19mils	
Substrate Potential	Unbiased	
Thermal Constants ($^{\circ}\text{C}/\text{W}$)	θ_{ja}	θ_{jc}
HA2-Metal Can (-2,-5)	212	58
HA2-Metal Can (-8)	173	52
HA7-Ceramic DIP (-2,-5)	218	123
HA7-Ceramic DIP (-8)	143	69
HA3-Plastic Mini-DIP (-5)	98	46