

Features

- High Speed10V/ μ s
- Wide Unity Gain Bandwidth8.5MHz
- Low Noise3nV/ $\sqrt{\text{Hz}}$ at 1KHz
- Low V_{OS} 10 μ V
- High CMRR126dB
- High Gain1800V/mV

Applications

- High Speed Signal Conditioners
- Wide Bandwidth Instrumentation Amplifiers
- Low Level Transducer Amplifiers
- Fast, Low Level Voltage Comparators
- Highest Quality Audio Preamplifiers
- Pulse/RF Amplifiers

Description

The HA-5127 monolithic operational amplifier features an unparalleled combination of precision DC and wideband high speed characteristics. Utilizing the Harris D. I. technology and advanced processing techniques, this unique design unites low noise (3nV/ $\sqrt{\text{Hz}}$) precision instrumentation performance with high speed (10V/ μ s) wideband capability.

This amplifier's impressive list of features include low V_{OS} (10 μ V), wide unity gain-bandwidth (8.5MHz), high open loop gain (1800V/mV), and high CMRR (126 dB). Additionally, this flexible device operates over a wide supply range (± 5 V to ± 20 V) while consuming only 140mW of power.

Using the HA-5127 allows designers to minimize errors while maximizing speed and bandwidth.

This device is ideally suited for low level transducer signal amplifier circuits. Other applications which can utilize the HA-5127's qualities include instrumentation amplifiers, pulse amplifiers, audio preamplifiers, and signal conditioning circuits.

This device can easily be used as a design enhancement by directly replacing the 725, OP25, OP06, OP07, OP27 and OP37. The HA-5127 is available in TO-99 Metal Can and Ceramic 8 pin Mini-DIPs. For the military grade product, refer to the HA-5127/883 data sheet.

Pinouts

TOP VIEWS
HA2-5127 (TO-99 METAL CAN)

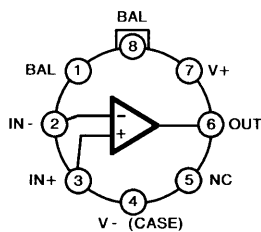

HA7-5127 (CERAMIC MINI-DIP)

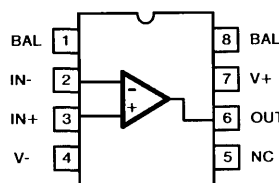

Schematic

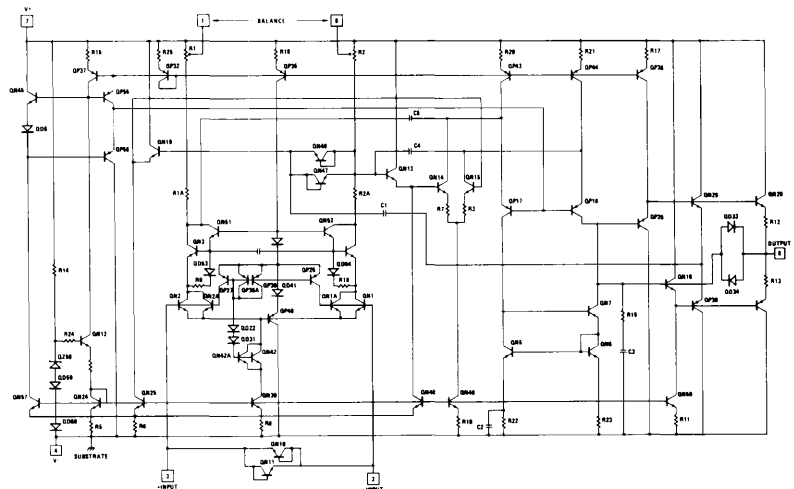

Specifications HA-5127

HA-5127

Absolute Maximum Ratings (Note 1)

$T_A = +25^\circ\text{C}$ Unless Otherwise Stated
 Voltage Between V^+ and V^- Terminals..... $\pm 22\text{V}$
 Differential Input Voltage (Note 2) $\pm 0.7\text{V}$
 Internal Power Dissipation..... 500mW
 Output Current..... Full Short Circuit Protection

Operating Temperature Ranges

HA-5127;27A-2 $-55^\circ\text{C} \leq T_A \leq +125^\circ\text{C}$
 HA-5127;27A-5 $0^\circ\text{C} \leq T_A \leq +75^\circ\text{C}$
 Storage Temperature Range $-65^\circ\text{C} \leq T_A \leq +150^\circ\text{C}$

Electrical Specifications $V^+ = 15\text{V}$, $V^- = -15\text{V}$, $C_L \leq 50\text{pF}$, $R_S \leq 100\Omega$

| PARAMETER | TEMP | HA-5127A | | | HA-5127 | | | UNITS |
|--|-------|------------|------------|----------|------------|------------|-----------|------------------------------|
| | | MIN | TYP | MAX | MIN | TYP | MAX | |
| INPUT CHARACTERISTICS | | | | | | | | |
| Offset Voltage | +25°C | | 10 | 25 | | 30 | 100 | μV |
| | Full | | 30 | 60 | | 70 | 300 | μV |
| Average Offset Voltage Drift | Full | | 0.2 | 0.6 | | 0.4 | 1.8 | $\mu\text{V}/^\circ\text{C}$ |
| Bias Current | +25°C | | ± 10 | ± 40 | | ± 15 | ± 80 | nA |
| | Full | | ± 20 | ± 60 | | ± 35 | ± 150 | nA |
| Offset Current | +25°C | | 7 | 35 | | 12 | 75 | nA |
| | Full | | 15 | 50 | | 30 | 135 | nA |
| Common Mode Range | Full | ± 10.3 | ± 11.5 | | ± 10.3 | ± 11.5 | | V |
| Differential Input Resistance (Note 3) | +25°C | 1.5 | 6 | | 0.8 | 4 | | M Ω |
| Input Noise Voltage 0.1Hz to 10Hz (Note 4) | +25°C | | 0.08 | .18 | | 0.09 | 0.25 | μV_{p-p} |
| Input Noise Voltage Density (Note 5) | +25°C | | | | | | | $\text{nV}/\sqrt{\text{Hz}}$ |
| $f_0 = 10\text{ Hz}$ | | | 3.5 | 5.5 | | 3.8 | 8.0 | |
| $f_0 = 30\text{ Hz}$ | | | 3.1 | 4.5 | | 3.3 | 5.6 | |
| $f_0 = 1000\text{ Hz}$ | | | 3.0 | 3.8 | | 3.2 | 4.5 | |
| Input Noise Current Density (Note 5) | +25°C | | | | | | | $\text{pA}/\sqrt{\text{Hz}}$ |
| $f_0 = 10\text{ Hz}$ | | | 1.7 | 4.0 | | 1.7 | | |
| $f_0 = 30\text{ Hz}$ | | | 1.0 | 2.3 | | 1.0 | | |
| $f_0 = 1000\text{ Hz}$ | | | 0.4 | 0.6 | | 0.4 | 0.6 | |
| TRANSFER CHARACTERISTICS | | | | | | | | |
| Large Signal Voltage Gain (Note 6) | +25°C | 1000 | 1800 | | 700 | 1500 | | V/mV |
| | Full | 600 | 1200 | | 300 | 800 | | V/mV |
| Common Mode Rejection Ratio (Note 7) | Full | 114 | 126 | | 100 | 120 | | dB |
| Minimum Stable Gain | +25°C | 1 | | | 1 | | | V/V |
| Unity-Gain-Bandwidth | +25°C | 5 | 8.5 | | 5 | 8.5 | | MHz |
| OUTPUT CHARACTERISTICS | | | | | | | | |
| Output Voltage Swing $R_L = 600\Omega$ | +25°C | ± 10.0 | ± 11.5 | | ± 10.0 | ± 11.5 | | V |
| $R_L = 2K\Omega$ | Full | ± 11.7 | ± 13.8 | | ± 11.4 | ± 13.5 | | V |
| Full Power Bandwidth (Note 8) | +25°C | 111 | 160 | | 111 | 160 | | KHz |
| Output Resistance, Open Loop | +25°C | | 70 | | | 70 | | Ω |
| TRANSIENT RESPONSE (Note 9) | | | | | | | | |
| Rise Time | +25°C | | | 150 | | | 150 | ns |
| Slew Rate (Note 11) | +25°C | 7 | 10 | | 7 | 10 | | V/ μs |
| Settling Time (Note 10) | +25°C | | 1.5 | | | 1.5 | | μs |
| Overshoot | +25°C | | 20 | 40 | | 20 | 40 | % |
| POWER SUPPLY CHARACTERISTICS | | | | | | | | |
| Supply Current | +25°C | | 3.5 | | | 3.5 | | mA |
| | Full | | | 4.0 | | | 4.0 | mA |
| Power Supply Rejection Ratio (Note 12) | Full | | 2 | 4 | | 16 | 51 | $\mu\text{V}/\text{V}$ |

2

OP AMPS & COMPARATORS

NOTES:

1. Absolute maximum ratings are limiting values, applied individually, beyond which the serviceability of the circuit may be impaired. Functional operability under any of these conditions is not necessarily implied.
2. For differential input voltages greater than 0.7V, the input current must be limited to 25mA to protect the back-to-back input diodes.
3. This parameter value is based upon design calculations.
4. Refer to Typical Performance section of the data sheet.
5. Sample tested.
6. $V_{OUT} = \pm 10V$, $R_L = 2K\Omega$
7. $V_{CM} = \pm 10V$
8. Full power bandwidth guaranteed based on slew rate measurement using: $FPBW = \frac{\text{Slew Rate}}{2\pi V_{PEAK}}$
9. Refer to Test Circuits section of the data sheet.
10. Settling time is specified to 0.1% of final value for a 10V output step and $A_v = -1$.
11. $V_{OUT} = 10V$ Step
12. $V_S = \pm 4V$ to $\pm 18V$

Typical Performance Curves Unless Otherwise Specified: $T_A = +25^\circ C$, $V_{SUPPLY} = \pm 15V$

**OFFSET VOLTAGE
TYPICAL DRIFT vs. TEMPERATURE**

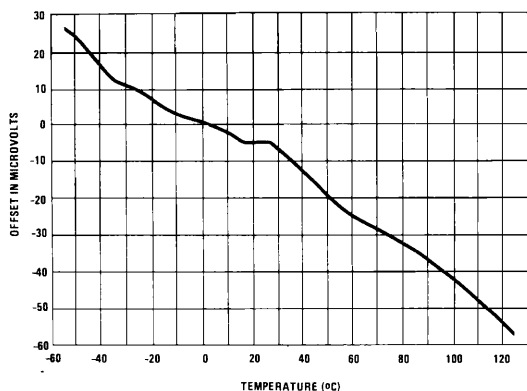

NOISE CHARACTERISTICS

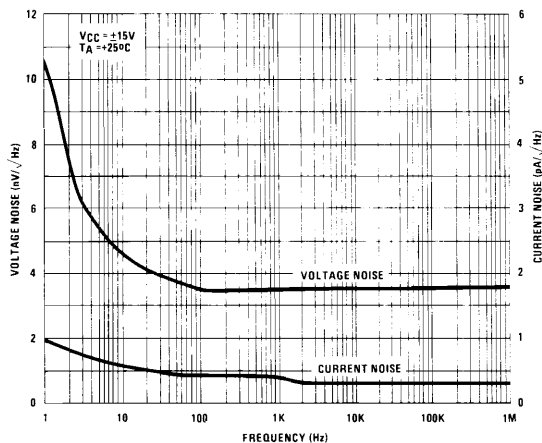

NOISE vs. SUPPLY VOLTAGE

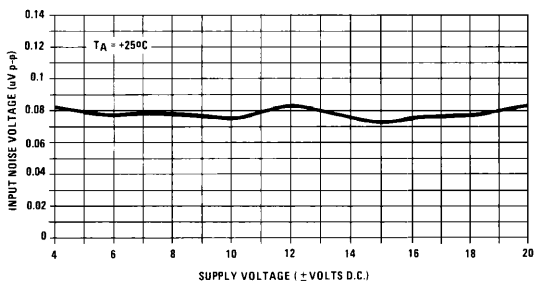

CMRR vs. FREQUENCY

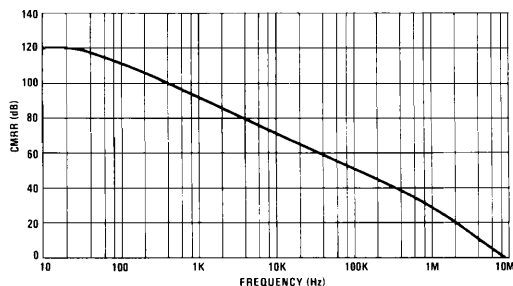

Typical Performance Curves Unless Otherwise Specified: $T_A = +25^\circ\text{C}$, $V_{\text{SUPPLY}} = \pm 15\text{V}$

PSRR vs. FREQUENCY

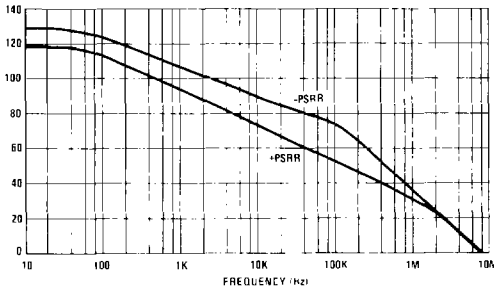

CLOSED LOOP GAIN AND PHASE vs. FREQUENCY

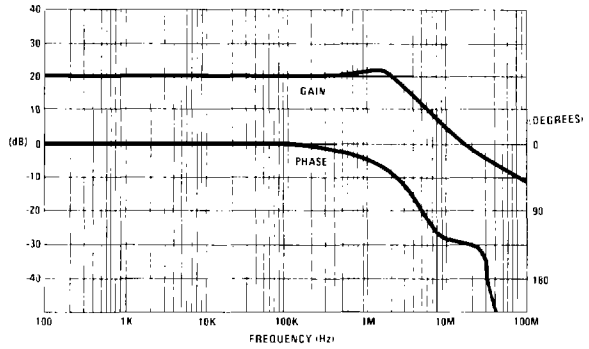

AVOL AND V_{OUT} vs. LOAD RESISTANCE

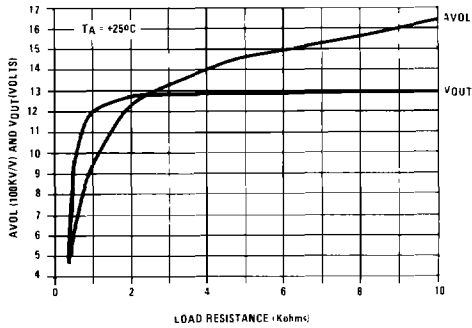

NORMALIZED SLEW RATE vs. TEMPERATURE

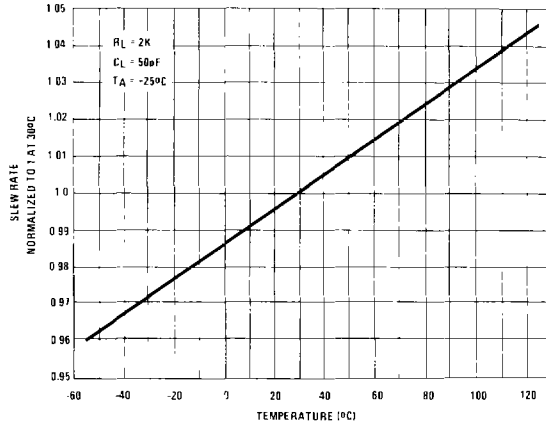

SUPPLY CURRENT vs. TEMPERATURE

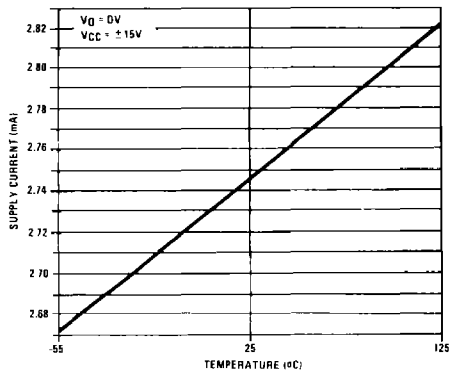

**$V_{\text{OUT MAX}}$ vs. FREQUENCY
UNDISTORTED SINEWAVE OUTPUT**

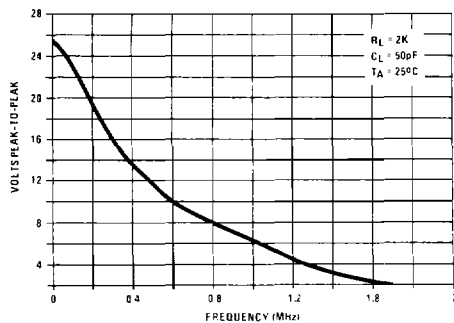

Typical Performance Curves Unless Otherwise Specified: $T_A = +25^{\circ}\text{C}$, $V_{\text{SUPPLY}} = \pm 15\text{V}$

OPEN LOOP GAIN AND PHASE vs. FREQUENCY

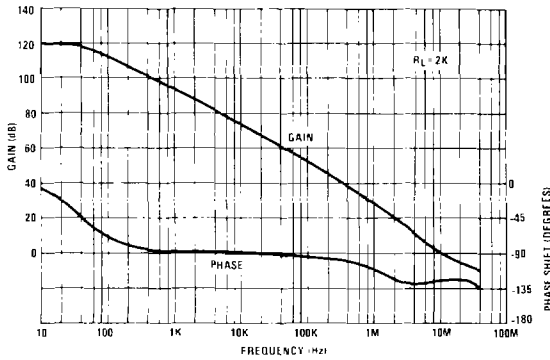

SUGGESTED OFFSET VOLTAGE ADJUSTMENT

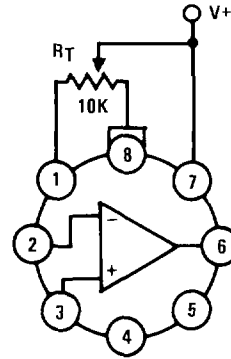

Tested Offset Adjustment Range is $|V_{OS} + 1\text{mV}|$ minimum referred to output. Typical range is $\pm 4\text{mV}$ with $R_T = 10\text{k}\Omega$.

LARGE AND SMALL SIGNAL RESPONSE TEST CIRCUIT

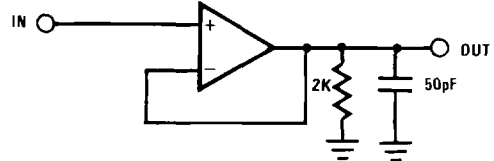
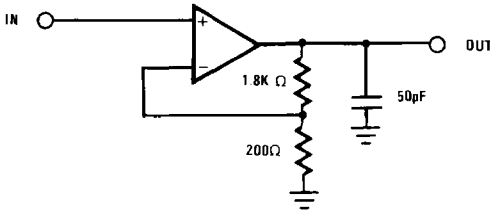

LARGE SIGNAL RESPONSE

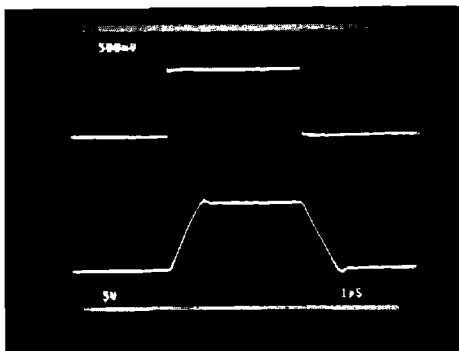

Vertical Scale: (Volts: Input = 0.5V/Div.)
(Output = 5V/Div.)
Horizontal Scale: (Time = 1 μs /Div.)

SMALL SIGNAL RESPONSE

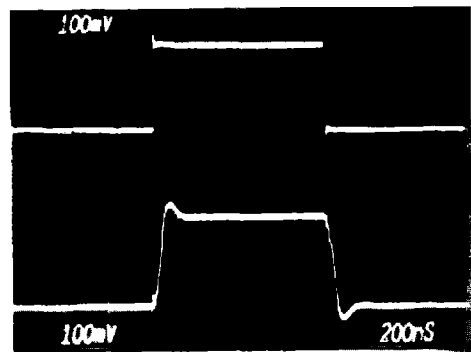

Vertical Scale: (Volts: 100mV/Div.)
Horizontal Scale: (200nS/Div.)

Typical Performance Curves Unless Otherwise Specified: $T_A = +25^\circ\text{C}$, $V_{\text{SUPPLY}} = \pm 15\text{V}$

SETTLING TIME TEST CIRCUIT

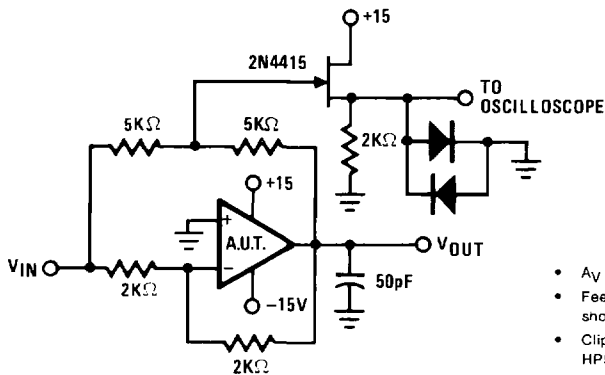

- $A_V = -1$
- Feedback and summing resistors should be 0.1% matched.
- Clipping diodes are optional. HP5082-2810 recommended.

SUGGESTED STABILITY CIRCUITS

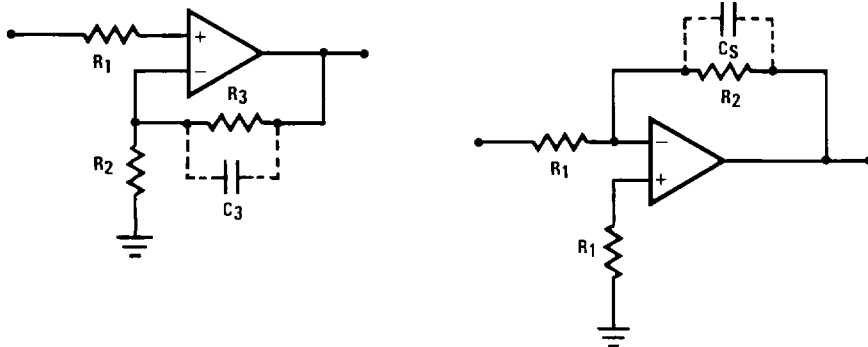

Low resistances are preferred for low noise applications as a 1K Ω resistor has $4\text{nV} \sqrt{\text{Hz}}$ of thermal noise. Total resistances of greater than 10K Ω on either input can reduce stability. In most high resistance applications a few picofarads of capacitance across the feedback resistor will improve stability.

0.1Hz TO 10Hz NOISE WITH $A_{CL} = 25,000\text{V/V}$

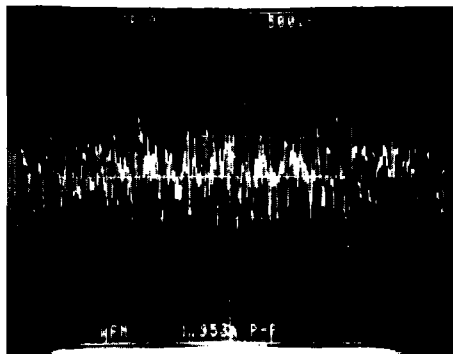

Horizontal Scale - 1sec/Div
 Vertical Scale 0.002 μV /Div
 0.08 μV p-p

HA-5127

Die Characteristics

| | |
|-------------------------------------|--|
| Transistor Count | 63 |
| Die Dimensions | 65 x 104.3 x 19mils (1700 x 2600 x 480 μ m) |
| Substrate Potential* | V- |
| Process | Bipolar-DI |
| Thermal Constants ($^{\circ}$ C/W) | θ_{ja} θ_{jc} |
| HA7-5127, Ceramic Mini-DIP | 160 79 |
| HA2-5127, TO-99 Metal Can | 172 48 |

*The substrate may be left floating (Insulating Die Mount) or it may be mounted on a conductor at V- potential.