

### General Description

Ideal for space critical applications, the LM4040 and LM4041 precision voltage references are available in the sub-miniature (3mm × 1.3mm) SOT-23 surface-mount package, the SO-8 surface-mount package, or the TO-92 package.

The LM4040 is the available in several fixed reverse breakdown voltages: 2.500V, 4.096V, 5.000V, 8.192V, and 10.000V.

The LM4041 is available with a fixed 1.225V or an adjustable reverse breakdown voltage.

The LM4040 and LM4041's advanced design eliminates the need for an external stabilizing capacitor while ensuring stability with any capacitive load, making them easy to use.

The minimum operating current increases from 60µA for the LM4041-1.2 to 100µA for the LM4040-10.0. LM4040 versions have a maximum operating current of 15mA. LM4041 versions have a maximum operating current of 12mA.

The LM4040 and LM4041 utilizes zener-zap reverse breakdown voltage trim during wafer sort to ensure that the prime parts have an accuracy of better than ±0.1% (A grade) at 25°C. Bandgap reference temperature drift curvature correction and low dynamic impedance ensure stable reverse breakdown voltage accuracy over a wide range of operating temperatures and currents.

### Features

- Small Package: SOT-23, TO-92, and SO-8
- No output capacitor required
- Tolerates capacitive loads
- Fixed reverse breakdown voltages of 1.225, 2.500V, 4.096V, 5.000V, 8.192V, and 10.000V
- Adjustable reverse breakdown version
- Contact Micrel for parts with extended temperature range.

### Key Specifications

- Output voltage tolerance (A grade, 25°C) ... ±0.1% (max)
- Low output noise (10Hz to 100Hz)
  - LM4040 ..... 35µV<sub>RMS</sub> (typ)
  - LM4041 ..... 20µV<sub>RMS</sub> (typ)
- Wide operating current range
  - LM4040 ..... 60µA to 15mA
  - LM4041 ..... 60µA to 12mA
- Industrial temperature range ..... -40°C to +85°C
- Low temperature coefficient ..... 100ppm/°C (max)

### Applications

- Battery-Powered Equipment
- Data Acquisition Systems
- Instrumentation
- Process Control
- Energy Management
- Product Testing
- Automotive Electronics
- Precision Audio Components

### Typical Applications

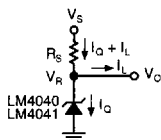

Figure 1. LM4040, LM4041 Fixed Shunt Regulator Application

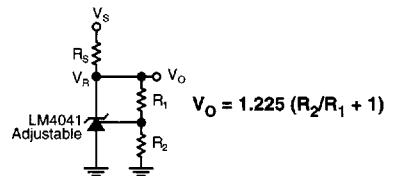

Figure 2. LM4041 Adjustable Shunt Regulator Application

### Recommended Parts\* (Ordering Information)

LM4040CIM-2.5	2.500V, ±0.5%	LM4040DIM-5.0	5.000V, ±1.0%	LM4041CIM3-1.2 T&R†	1.225V, ±0.5%
LM4040DIM-2.5	2.500V, ±1.0%	LM4040DIM3-5.0 T&R†	5.000V, ±1.0%	LM4041DIM3-1.2 T&R†	1.225V, ±1.0%
LM4040CIM3-2.5 T&R†	2.500V, ±0.5%	LM4040DIZ-5.0	5.000V, ±1.0%	LM4041DIZ-1.2	1.225V, ±1.0%
LM4040DIM3-2.5 T&R†	2.500V, ±1.0%			LM4041CIM3-ADJ T&R†	1.24–10V, ±0.5%
LM4040CIZ-2.5	2.500V, ±0.5%			LM4041DIM3-ADJ T&R†	1.24–10V, ±1.0%
LM4040DIZ-2.5	2.500V, ±1.0%			LM4041DIZ-ADJ	1.24–10V, ±1.0%

\*Contact factory for availability of other part numbers.

†M3 (SOT-23) package available in Tape & Reel only.

### Pin Configuration

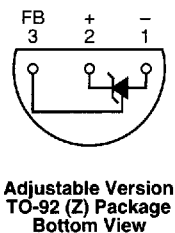
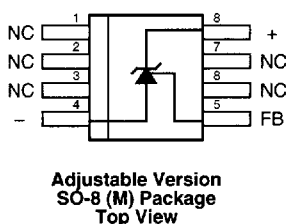
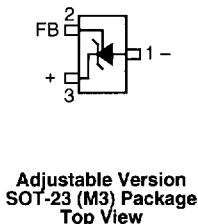
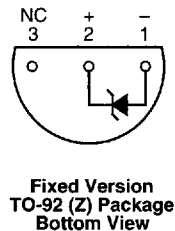
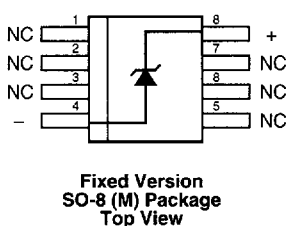
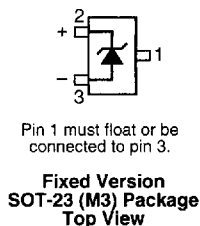

### Ordering Information† (Expanded Version)

Part Number	Voltage	Accuracy, Temp. Coefficient
LM4040AI*-2.5	2.500V	±0.1%, 100ppm/°C
LM4040BI*-2.5	2.500V	±0.2%, 100ppm/°C
LM4040CI*-2.5	2.500V	±0.5%, 100ppm/°C
LM4040DI*-2.5	2.500V	±1.0%, 150ppm/°C
LM4040EI*-2.5†	2.500V	±2.0%, 150ppm/°C
LM4040AI*-4.1	4.096V	±0.1%, 100ppm/°C
LM4040BI*-4.1	4.096V	±0.2%, 100ppm/°C
LM4040CI*-4.1	4.096V	±0.5%, 100ppm/°C
LM4040DI*-4.1	4.096V	±1.0%, 150ppm/°C
LM4040AI*-5.0	5.000V	±0.1%, 100ppm/°C
LM4040BI*-5.0	5.000V	±0.2%, 100ppm/°C
LM4040CI*-5.0	5.000V	±0.5%, 100ppm/°C
LM4040DI*-5.0	5.000V	±1.0%, 150ppm/°C
LM4040AI*-8.2	8.192V	±0.1%, 100ppm/°C
LM4040BI*-8.2	8.192V	±0.2%, 100ppm/°C

Part Number	Voltage	Accuracy, Temp. Coefficient
LM4040CI*-8.2	8.192V	±0.5%, 100ppm/°C
LM4040DI*-8.2	8.192V	±1.0%, 150ppm/°C
LM4040AI*-10.0	10.00V	±0.1%, 100ppm/°C
LM4040BI*-10.0	10.00V	±0.2%, 100ppm/°C
LM4040CI*-10.0	10.00V	±0.5%, 100ppm/°C
LM4040DI*-10.0	10.00V	±1.0%, 150ppm/°C
LM4041AI*-1.2	1.225V	±0.1%, 100ppm/°C
LM4041BI*-1.2	1.225V	±0.2%, 100ppm/°C
LM4041CI*-1.2	1.225V	±0.5%, 100ppm/°C
LM4041DI*-1.2	1.225V	±1.0%, 150ppm/°C
LM4041EI*-1.2†	1.225V	±2.0%, 150ppm/°C
LM4041CI*-ADJ	1.24V to 10V	±0.5%, 100ppm/°C
LM4041DI*-ADJ	1.24V to 10V	±1.0%, 150ppm/°C

Refer to **Recommended Parts** list for most common part numbers.  
 Contact factory for availability of other part numbers.  
 \* M = SO-8, M3 = SOT-23, Z = TO-92  
 † available only in M3 and Z packages  
 ‡ M3 (SOT-23) available in Tape and Reel only. Add suffix "T&R".  
 Quantity = 3000/reel.

### SOT-23 Package Markings (Example: R4A)

Example	Field	Code
R __	1st Character	R = Reference

**Explanation:** The SOT-23 package size does not allow conventional part number markings, therefore a 3-character coding system is used for identification. See note for 3rd character.

**Example:** R4A represents Reference, 4.096V, ±0.1% (LM4040AIM3-4.1)

Example	Field	Code
_ 4 _	2nd Character	1 = 1.225V 2 = 2.500V 4 = 4.096V 5 = 5.000V 8 = 8.192V 10 = 10.00V A = Adjustable

Example	Field	Code
_ _ A	3rd Character	A = ±0.1% B = ±0.2% C = ±0.5% D = ±1.0% E = ±2.0%

**Note:** If 3rd character is omitted, container will indicate tolerance.

## Functional Diagram LM4040, LM4041 Fixed

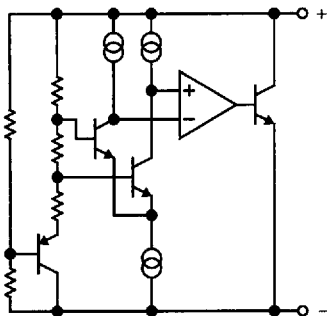

## Functional Diagram LM4041 Adjustable

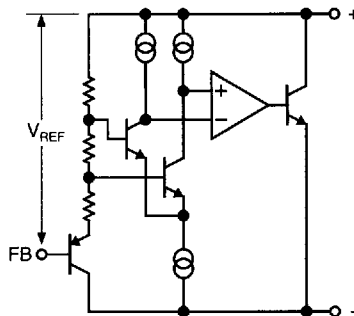

### Absolute Maximum Ratings

Reverse Current .....	20mA
Forward Current .....	10mA
Maximum Output Voltage	
LM4041-Adjustable .....	15V
Power Dissipation ( $T_A = 25^\circ\text{C}$ ) (Note 2)	
M Package .....	540mW
M3 Package .....	306mW
Z Package .....	550mW
Storage Temperature .....	$-65^\circ\text{C}$ to $+150^\circ\text{C}$
Lead Temperature	
M and M3 Packages	
Vapor phase (60 seconds) .....	$+215^\circ\text{C}$
Infrared (15 seconds) .....	$+220^\circ\text{C}$
Z Package	
Soldering (10 seconds) .....	$+260^\circ\text{C}$
ESD Susceptibility	
Human Body Model (Note 3) .....	2kV
Machine Model (Note 3) .....	200V

### LM4040 and LM4041 Applications Information

The LM4040 and LM4041 have been designed for stable operation without the need of an external capacitor connected between the (+) and (-) pins. If a bypass capacitor is used, the references remain stable.

#### SOT-23 Versions

LM4040-x.x and LM4041-1.2s in the SOT-23 packages have a parasitic Schottky diode between pin 3 (-) and pin 1 (die attach interface connect). Pin 1 of the SOT-23 package must float or be connected to pin 3. LM4041-ADJs use pin 1 as the (-) output.

### Operating Ratings (Notes 1 & 2)

Temperature Range	
( $T_{\text{MIN}} \leq T_A \leq T_{\text{MAX}}$ ) .....	$-40^\circ\text{C} \leq T_A \leq +85^\circ\text{C}$
Reverse Current	
LM4040-2.5 .....	60 $\mu\text{A}$ to 15mA
LM4040-4.1 .....	68 $\mu\text{A}$ to 15mA
LM4040-5.0 .....	74 $\mu\text{A}$ to 15mA
LM4040-8.2 .....	91 $\mu\text{A}$ to 15mA
LM4040-10.0 .....	100 $\mu\text{A}$ to 15mA
LM4041-1.2 .....	60 $\mu\text{A}$ to 12mA
LM4041-ADJ .....	60 $\mu\text{A}$ to 12mA
Output Voltage Range	
LM4041-ADJ .....	1.24V to 10V

#### Conventional Shunt Regulator

In a conventional shunt regulator application (see Figure 1), an external series resistor ( $R_S$ ) is connected between the supply voltage and the LM4040-x.x or LM4041-1.2 reference.  $R_S$  determines the current that flows through the load ( $I_L$ ) and the reference ( $I_Q$ ). Since load current and supply voltage may vary,  $R_S$  should be small enough to supply at least the minimum acceptable  $I_Q$  to the reference even when the supply voltage is at its minimum and the load current is at its

*(continued following LM4041 typical characteristics)*

## LM4040-2.5 Electrical Characteristics

**Boldface limits apply for  $T_A = T_J = T_{MIN}$  to  $T_{MAX}$** ; all other limits  $T_A = T_J = 25^\circ\text{C}$ . The grades A, B, C, D, and E designate initial Reverse Breakdown Voltage tolerance of  $\pm 0.1\%$ ,  $\pm 0.2\%$ ,  $\pm 0.5\%$ ,  $\pm 1.0\%$ , and  $\pm 2.0$  respectively.

Symbol	Parameter	Conditions	Typical (Note 4)	LM4040AIM	LM4040BIM	LM4040CIM	Units (Limit)
				LM4040AIM3 LM4040AIZ Limits (Note 5)	LM4040BIM3 LM4040BIZ Limits (Note 5)	LM4040CIM3 LM4040CIZ Limits (Note 5)	
$V_R$	Reverse Breakdown Voltage	$I_R = 100\mu\text{A}$	2.500				V
	Reverse Breakdown Voltage Tolerance	$I_R = 100\mu\text{A}$		$\pm 2.5$ <b><math>\pm 19</math></b>	$\pm 5.0$ <b><math>\pm 21</math></b>	$\pm 12$ <b><math>\pm 29</math></b>	mV (max) mV (max)
$I_{RMIN}$	Minimum Operating Current		45	60	60	60	$\mu\text{A}$
				<b>65</b>	<b>65</b>	<b>65</b>	$\mu\text{A}$ (max) $\mu\text{A}$ (max)
$\Delta V_R/\Delta T$	Average Reverse Breakdown Voltage Temperature Coefficient	$I_R = 10\text{mA}$	20				ppm/ $^\circ\text{C}$
		$I_R = 1\text{mA}$	15	<b>100</b>	<b>100</b>	<b>100</b>	ppm/ $^\circ\text{C}$ (max)
		$I_R = 100\mu\text{A}$	15				ppm/ $^\circ\text{C}$ (max)
$\Delta V_R/\Delta I_R$	Reverse Breakdown Voltage Change with Operating Current Change	$I_{RMIN} \leq I_R 1\text{mA}$	0.3	0.8	0.8	0.8	mV
			<b>1.0</b>	<b>1.0</b>	<b>1.0</b>	mV (max) mV (max)	
		$1\text{mA} \leq I_R 15\text{mA}$	2.5	0.6	0.6	0.6	mV
			<b>8.0</b>	<b>8.0</b>	<b>8.0</b>	mV (max) mV (max)	
$Z_R$	Reverse Dynamic Impedance	$I_R = 1\text{mA}$ , $f = 120\text{Hz}$ $I_{AC} = 0.1 I_R$	0.3	0.8	0.8	0.9	$\Omega$
							$\Omega$ (max)
$e_N$	Wideband Noise	$I_R = 100\mu\text{A}$ $10\text{Hz} \leq f \leq 10\text{kHz}$	35				$\mu\text{V}_{RMS}$
$\Delta V_R$	Reverse Breakdown Voltage Long Term Stability	$t = 1000\text{hrs}$ $T = 25^\circ\text{C} \pm 0.1^\circ\text{C}$ $I_R = 100\mu\text{A}$	120				ppm
Symbol	Parameter	Conditions	Typical (Note 4)	LM4040DIM	LM4040EIM3		Units (Limit)
$V_R$	Reverse Breakdown Voltage	$I_R = 100\mu\text{A}$	2.500				V
	Reverse Breakdown Voltage Tolerance	$I_R = 100\mu\text{A}$		$\pm 25$ <b><math>\pm 49</math></b>	$\pm 50$ <b><math>\pm 74</math></b>		mV (max) mV (max)
$I_{RMIN}$	Minimum Operating Current		45	65	65		$\mu\text{A}$
				<b>70</b>	<b>70</b>		$\mu\text{A}$ (max) $\mu\text{A}$ (max)
$\Delta V_R/\Delta T$	Average Reverse Breakdown Voltage Temperature Coefficient	$I_R = 10\text{mA}$	20				ppm/ $^\circ\text{C}$
		$I_R = 1\text{mA}$	15	<b>150</b>	<b>150</b>		ppm/ $^\circ\text{C}$ (max)
		$I_R = 100\mu\text{A}$	15				ppm/ $^\circ\text{C}$ (max)
$\Delta V_R/\Delta I_R$	Reverse Breakdown Voltage Change with Operating Current Change	$I_{RMIN} \leq I_R 1\text{mA}$	0.3	1.0	1.0		mV
			<b>1.2</b>	<b>1.2</b>		mV (max) mV (max)	
		$1\text{mA} \leq I_R 15\text{mA}$	2.5	8.0	8.0		mV
			<b>10.0</b>	<b>10.0</b>		mV (max) mV (max)	
$Z_R$	Reverse Dynamic Impedance	$I_R = 1\text{mA}$ , $f = 120\text{Hz}$ $I_{AC} = 0.1 I_R$	0.3	1.1	1.1		$\Omega$
							$\Omega$ (max)
$e_N$	Wideband Noise	$I_R = 100\mu\text{A}$ $10\text{Hz} \leq f \leq 10\text{kHz}$	35				$\mu\text{V}_{RMS}$
$\Delta V_R$	Reverse Breakdown Voltage Long Term Stability	$t = 1000\text{hrs}$ $T = 25^\circ\text{C} \pm 0.1^\circ\text{C}$ $I_R = 100\mu\text{A}$	120				ppm

## LM4040-4.1 Electrical Characteristics

**Boldface limits apply for  $T_A = T_J = T_{MIN}$  to  $T_{MAX}$** ; all other limits  $T_A = T_J = 25^\circ\text{C}$ . The grades A, B, C, and D designate initial Reverse Breakdown Voltage tolerance of  $\pm 0.1\%$ ,  $\pm 0.2\%$ ,  $\pm 0.5\%$ , and  $\pm 1.0\%$  respectively.

Symbol	Parameter	Conditions	Typical (Note 4)	LM4040AIM LM4040AIM3 LM4040AIZ Limits (Note 5)	LM4040BIM LM4040BIM3 LM4040BIZ Limits (Note 5)	Units (Limit)
$V_R$	Reverse Breakdown Voltage	$I_R = 100\mu\text{A}$	4.096			V
	Reverse Breakdown Voltage Tolerance	$I_R = 100\mu\text{A}$		$\pm 4.1$ $\pm 31$	$\pm 8.2$ $\pm 35$	mV (max) mV (max)
$I_{RMIN}$	Minimum Operating Current		50	68 73	68 73	$\mu\text{A}$ $\mu\text{A}$ (max) $\mu\text{A}$ (max)
$\Delta V_R/\Delta T$	Average Reverse Breakdown Voltage Temperature Coefficient	$I_R = 10\text{mA}$ $I_R = 1\text{mA}$ $I_R = 100\mu\text{A}$	30 20 20	100	100	ppm/ $^\circ\text{C}$ ppm/ $^\circ\text{C}$ (max) ppm/ $^\circ\text{C}$ (max)
$\Delta V_R/\Delta I_R$	Reverse Breakdown Voltage Change with Operating Current Change	$I_{RMIN} \leq I_R 1\text{mA}$	0.5	0.9 1.2	0.9 1.2	mV mV (max) mV (max)
		$1\text{mA} \leq I_R 15\text{mA}$	3.0	7.0 10.0	7.0 10.0	mV mV (max) mV (max)
$Z_R$	Reverse Dynamic Impedance	$I_R = 1\text{mA}$ , $f = 120\text{Hz}$ $I_{AC} = 0.1 I_R$	0.5	1.0	1.0	$\Omega$ $\Omega$ (max)
$e_N$	Wideband Noise	$I_R = 100\mu\text{A}$ $10\text{Hz} \leq f \leq 10\text{kHz}$	80			$\mu\text{V}_{RMS}$
$\Delta V_R$	Reverse Breakdown Voltage Long Term Stability	$t = 1000\text{hrs}$ $T = 25^\circ\text{C} \pm 0.1^\circ\text{C}$ $I_R = 100\mu\text{A}$	120			ppm
Symbol	Parameter	Conditions	Typical (Note 4)	LM4040CIM LM4040CIM3 LM4040CIZ Limits (Note 5)	LM4040DIM LM4040DIM3 LM4040DIZ Limits (Note 5)	Units (Limits)
$V_R$	Reverse Breakdown Voltage	$I_R = 100\mu\text{A}$	4.096			V
	Reverse Breakdown Voltage Tolerance	$I_R = 100\mu\text{A}$		$\pm 20$ $\pm 47$	$\pm 41$ $\pm 81$	mV (max) mV (max)
$I_{RMIN}$	Minimum Operating Current		50	68 73	73 78	$\mu\text{A}$ $\mu\text{A}$ (max) $\mu\text{A}$ (max)
$\Delta V_R/\Delta T$	Average Reverse Breakdown Voltage Temperature Coefficient	$I_R = 10\text{mA}$ $I_R = 1\text{mA}$ $I_R = 100\mu\text{A}$	30 20 20	100	150	ppm/ $^\circ\text{C}$ ppm/ $^\circ\text{C}$ (max) ppm/ $^\circ\text{C}$ (max)
$\Delta V_R/\Delta I_R$	Reverse Breakdown Voltage Change with Operating Current Change	$I_{RMIN} \leq I_R 1\text{mA}$	0.5	0.9 1.2	1.2 1.5	mV mV (max) mV (max)
		$1\text{mA} \leq I_R 15\text{mA}$	3.0	7.0 10.0	9.0 13.0	mV mV (max) mV (max)
$Z_R$	Reverse Dynamic Impedance	$I_R = 1\text{mA}$ , $f = 120\text{Hz}$ $I_{AC} = 0.1 I_R$	0.5	1.0	1.3	$\Omega$ $\Omega$ (max)
$e_N$	Wideband Noise	$I_R = 100\mu\text{A}$ $10\text{Hz} \leq f \leq 10\text{kHz}$	80			$\mu\text{V}_{RMS}$
$\Delta V_R$	Reverse Breakdown Voltage Long Term Stability	$t = 1000\text{hrs}$ $T = 25^\circ\text{C} \pm 0.1^\circ\text{C}$ $I_R = 100\mu\text{A}$	120			ppm

## LM4040-5.0 Electrical Characteristics

**Boldface limits apply for  $T_A = T_J = T_{MIN}$  to  $T_{MAX}$** ; all other limits  $T_A = T_J = 25^\circ\text{C}$ . The grades A, B, C, and D designate initial Reverse Breakdown Voltage tolerance of  $\pm 0.1\%$ ,  $\pm 0.2\%$ ,  $\pm 0.5\%$ , and  $\pm 1.0\%$  respectively.

Symbol	Parameter	Conditions	Typical (Note 4)	LM4040AIM LM4040AIM3 LM4040AIZ Limits (Note 5)	LM4040BIM LM4040BIM3 LM4040BIZ Limits (Note 5)	Units (Limit)
$V_R$	Reverse Breakdown Voltage	$I_R = 100\mu\text{A}$	5.000			V
	Reverse Breakdown Voltage Tolerance	$I_R = 100\mu\text{A}$		$\pm 5.0$ <b><math>\pm 38</math></b>	$\pm 10$ <b><math>\pm 43</math></b>	mV (max) mV (max)
$I_{RMIN}$	Minimum Operating Current		54	74 <b>80</b>	74 <b>80</b>	$\mu\text{A}$ $\mu\text{A}$ (max) $\mu\text{A}$ (max)
$\Delta V_R/\Delta T$	Average Reverse Breakdown Voltage Temperature Coefficient	$I_R = 10\text{mA}$ $I_R = 1\text{mA}$ $I_R = 100\mu\text{A}$	30 20 20	<b>100</b>	<b>100</b>	ppm/ $^\circ\text{C}$ ppm/ $^\circ\text{C}$ (max) ppm/ $^\circ\text{C}$ (max)
$\Delta V_R/\Delta I_R$	Reverse Breakdown Voltage Change with Operating Current Change	$I_{RMIN} \leq I_R 1\text{mA}$	0.5	1.0 <b>1.4</b>	1.0 <b>1.4</b>	mV mV (max) mV (max)
		$1\text{mA} \leq I_R 15\text{mA}$	3.5	8.0 <b>12.0</b>	8.0 <b>12.0</b>	mV mV (max) mV (max)
$Z_R$	Reverse Dynamic Impedance	$I_R = 1\text{mA}$ , $f = 120\text{Hz}$ $I_{AC} = 0.1 I_R$	0.5	1.1	1.1	$\Omega$ $\Omega$ (max)
$e_N$	Wideband Noise	$I_R = 100\mu\text{A}$ $10\text{Hz} \leq f \leq 10\text{kHz}$	80			$\mu\text{V}_{RMS}$
$\Delta V_R$	Reverse Breakdown Voltage Long Term Stability	$t = 1000\text{hrs}$ $T = 25^\circ\text{C} \pm 0.1^\circ\text{C}$ $I_R = 100\mu\text{A}$	40			ppm
Symbol	Parameter	Conditions	Typical (Note 4)	LM4040CIM LM4040CIM3 LM4040CIZ Limits (Note 5)	LM4040DIM LM4040DIM3 LM4040DIZ Limits (Note 5)	Units (Limits)
$V_R$	Reverse Breakdown Voltage	$I_R = 100\mu\text{A}$	5.000			V
	Reverse Breakdown Voltage Tolerance	$I_R = 100\mu\text{A}$		$\pm 25$ <b><math>\pm 58</math></b>	$\pm 50$ <b><math>\pm 99</math></b>	mV (max) mV (max)
$I_{RMIN}$	Minimum Operating Current		54	74 <b>80</b>	79 <b>85</b>	$\mu\text{A}$ $\mu\text{A}$ (max) $\mu\text{A}$ (max)
$\Delta V_R/\Delta T$	Average Reverse Breakdown Voltage Temperature Coefficient	$I_R = 10\text{mA}$ $I_R = 1\text{mA}$ $I_R = 100\mu\text{A}$	30 20 20	<b>100</b>	<b>150</b>	ppm/ $^\circ\text{C}$ ppm/ $^\circ\text{C}$ (max) ppm/ $^\circ\text{C}$ (max)
$\Delta V_R/\Delta I_R$	Reverse Breakdown Voltage Change with Operating Current Change	$I_{RMIN} \leq I_R 1\text{mA}$	0.5	1.0 <b>1.3</b>	1.3 <b>1.8</b>	mV mV (max) mV (max)
		$1\text{mA} \leq I_R 15\text{mA}$	3.5	8.0 <b>12.0</b>	10.0 <b>15.0</b>	mV mV (max) mV (max)
$Z_R$	Reverse Dynamic Impedance	$I_R = 1\text{mA}$ , $f = 120\text{Hz}$ $I_{AC} = 0.1 I_R$	0.5	1.1	1.5	$\Omega$ $\Omega$ (max)
$e_N$	Wideband Noise	$I_R = 100\mu\text{A}$ $10\text{Hz} \leq f \leq 10\text{kHz}$	80			$\mu\text{V}_{RMS}$
$\Delta V_R$	Reverse Breakdown Voltage Long Term Stability	$t = 1000\text{hrs}$ $T = 25^\circ\text{C} \pm 0.1^\circ\text{C}$ $I_R = 100\mu\text{A}$	120			ppm

## LM4040-8.2 Electrical Characteristics

**Boldface limits apply for  $T_A = T_J = T_{MIN}$  to  $T_{MAX}$ ;** all other limits  $T_A = T_J = 25^\circ\text{C}$ . The grades A, B, C, and D designate initial Reverse Breakdown Voltage tolerance of  $\pm 0.1\%$ ,  $\pm 0.2\%$ ,  $\pm 0.5\%$ , and  $\pm 1.0\%$  respectively.

Symbol	Parameter	Conditions	Typical (Note 4)	LM4040AIM LM4040AIM3 LM4040AIZ Limits (Note 5)	LM4040BIM LM4040BIM3 LM4040BIZ Limits (Note 5)	Units (Limit)
$V_R$	Reverse Breakdown Voltage	$I_R = 150\mu\text{A}$	8.192			V
	Reverse Breakdown Voltage Tolerance	$I_R = 150\mu\text{A}$		$\pm 8.2$ <b><math>\pm 61</math></b>	$\pm 16$ <b><math>\pm 70</math></b>	mV (max) mV (max)
$I_{RMIN}$	Minimum Operating Current		67	91	91	$\mu\text{A}$
				<b>95</b>	<b>95</b>	$\mu\text{A}$ (max) $\mu\text{A}$ (max)
$\Delta V_R/\Delta T$	Average Reverse Breakdown Voltage Temperature Coefficient	$I_R = 10\text{mA}$	40			ppm/ $^\circ\text{C}$
		$I_R = 1\text{mA}$	20	<b>100</b>	<b>100</b>	ppm/ $^\circ\text{C}$ (max)
		$I_R = 150\mu\text{A}$	20			ppm/ $^\circ\text{C}$ (max)
$\Delta V_R/\Delta I_R$	Reverse Breakdown Voltage Change with Operating Current Change	$I_{RMIN} \leq I_R 1\text{mA}$	0.6	1.3 <b>2.5</b>	1.3 <b>2.5</b>	mV mV (max) mV (max)
		$1\text{mA} \leq I_R 15\text{mA}$	7.0	10.0 <b>18.0</b>	10.0 <b>18.0</b>	mV mV (max) mV (max)
$Z_R$	Reverse Dynamic Impedance	$I_R = 1\text{mA}$ , $f = 120\text{Hz}$ $I_{AC} = 0.1 I_R$	0.6	1.5	1.5	$\Omega$ $\Omega$ (max)
$e_N$	Wideband Noise	$I_R = 150\mu\text{A}$ $10\text{Hz} \leq f \leq 10\text{kHz}$	130			$\mu\text{V}_{RMS}$
$\Delta V_R$	Reverse Breakdown Voltage Long Term Stability	$t = 1000\text{hrs}$ $T = 25^\circ\text{C} \pm 0.1^\circ\text{C}$ $I_R = 150\mu\text{A}$	120			ppm
Symbol	Parameter	Conditions	Typical (Note 4)	LM4040CIM LM4040CIM3 LM4040CIZ Limits (Note 5)	LM4040DIM LM4040DIM3 LM4040DIZ Limits (Note 5)	Units (Limits)
$V_R$	Reverse Breakdown Voltage	$I_R = 150\mu\text{A}$	8.192			V
	Reverse Breakdown Voltage Tolerance	$I_R = 150\mu\text{A}$		$\pm 41$ <b><math>\pm 94</math></b>	$\pm 82$ <b><math>\pm 162</math></b>	mV (max) mV (max)
$I_{RMIN}$	Minimum Operating Current		67	91	96	$\mu\text{A}$
				<b>95</b>	<b>100</b>	$\mu\text{A}$ (max) $\mu\text{A}$ (max)
$\Delta V_R/\Delta T$	Average Reverse Breakdown Voltage Temperature Coefficient	$I_R = 10\text{mA}$	40			ppm/ $^\circ\text{C}$
		$I_R = 1\text{mA}$	20	<b>100</b>	<b>150</b>	ppm/ $^\circ\text{C}$ (max)
		$I_R = 150\mu\text{A}$	20			ppm/ $^\circ\text{C}$ (max)
$\Delta V_R/\Delta I_R$	Reverse Breakdown Voltage Change with Operating Current Change	$I_{RMIN} \leq I_R 1\text{mA}$	0.6	1.3 <b>2.5</b>	1.7 <b>3.0</b>	mV mV (max) mV (max)
		$1\text{mA} \leq I_R 15\text{mA}$	7.0	10.0 <b>18.0</b>	15.0 <b>24.0</b>	mV mV (max) mV (max)
$Z_R$	Reverse Dynamic Impedance	$I_R = 1\text{mA}$ , $f = 120\text{Hz}$ $I_{AC} = 0.1 I_R$	0.6	1.5	1.9	$\Omega$ $\Omega$ (max)
$e_N$	Wideband Noise	$I_R = 150\mu\text{A}$ $10\text{Hz} \leq f \leq 10\text{kHz}$	130			$\mu\text{V}_{RMS}$
$\Delta V_R$	Reverse Breakdown Voltage Long Term Stability	$t = 1000\text{hrs}$ $T = 25^\circ\text{C} \pm 0.1^\circ\text{C}$ $I_R = 150\mu\text{A}$	120			ppm

## LM4040-10.0 Electrical Characteristics

**Boldface limits apply for  $T_A = T_J = T_{MIN}$  to  $T_{MAX}$ ;** all other limits  $T_A = T_J = 25^\circ\text{C}$ . The grades A, B, C, and D designate initial Reverse Breakdown Voltage tolerance of  $\pm 0.1\%$ ,  $\pm 0.2\%$ ,  $\pm 0.5\%$ , and  $\pm 1.0\%$  respectively.

Symbol	Parameter	Conditions	Typical (Note 4)	LM4040AIM LM4040AIM3 LM4040AIZ Limits (Note 5)	LM4040BIM LM4040BIM3 LM4040BIZ Limits (Note 5)	Units (Limit)
$V_R$	Reverse Breakdown Voltage	$I_R = 150\mu\text{A}$	10.00			V
	Reverse Breakdown Voltage Tolerance	$I_R = 150\mu\text{A}$		$\pm 10$ $\pm 75$	$\pm 20$ $\pm 85$	mV (max) mV (max)
$I_{RMIN}$	Minimum Operating Current		75	100 103	100 103	$\mu\text{A}$ $\mu\text{A}$ (max) $\mu\text{A}$ (max)
$\Delta V_R/\Delta T$	Average Reverse Breakdown Voltage Temperature Coefficient	$I_R = 10\text{mA}$ $I_R = 1\text{mA}$ $I_R = 150\mu\text{A}$	40 20 20	100	100	ppm/ $^\circ\text{C}$ ppm/ $^\circ\text{C}$ (max) ppm/ $^\circ\text{C}$ (max)
$\Delta V_R/\Delta I_R$	Reverse Breakdown Voltage Change with Operating Current Change	$I_{RMIN} \leq I_R 1\text{mA}$	0.8	1.5 3.5	1.6 3.5	mV mV (max) mV (max)
		$1\text{mA} \leq I_R 15\text{mA}$	8.0	12.0 23.0	12.0 23.0	mV mV (max) mV (max)
$Z_R$	Reverse Dynamic Impedance	$I_R = 1\text{mA}$ , $f = 120\text{Hz}$ $I_{AC} = 0.1 I_R$	0.7	1.7	1.7	$\Omega$ $\Omega$ (max)
$e_N$	Wideband Noise	$I_R = 150\mu\text{A}$ $10\text{Hz} \leq f \leq 10\text{kHz}$	180			$\mu\text{V}_{RMS}$
$\Delta V_R$	Reverse Breakdown Voltage Long Term Stability	$t = 1000\text{hrs}$ $T = 25^\circ\text{C} \pm 0.1^\circ\text{C}$ $I_R = 150\mu\text{A}$	120			ppm
Symbol	Parameter	Conditions	Typical (Note 4)	LM4040CIM LM4040CIM3 LM4040CIZ Limits (Note 5)	LM4040DIM LM4040DIM3 LM4040DIZ Limits (Note 5)	Units (Limits)
$V_R$	Reverse Breakdown Voltage	$I_R = 150\mu\text{A}$	10.00			V
	Reverse Breakdown Voltage Tolerance	$I_R = 150\mu\text{A}$		$\pm 50$ $\pm 115$	$\pm 100$ $\pm 198$	mV (max) mV (max)
$I_{RMIN}$	Minimum Operating Current		75	100 103	110 113	$\mu\text{A}$ $\mu\text{A}$ (max) $\mu\text{A}$ (max)
$\Delta V_R/\Delta T$	Average Reverse Breakdown Voltage Temperature Coefficient	$I_R = 10\text{mA}$ $I_R = 1\text{mA}$ $I_R = 150\mu\text{A}$	40 20 20	100	150	ppm/ $^\circ\text{C}$ ppm/ $^\circ\text{C}$ (max) ppm/ $^\circ\text{C}$ (max)
$\Delta V_R/\Delta I_R$	Reverse Breakdown Voltage Change with Operating Current Change	$I_{RMIN} \leq I_R 1\text{mA}$	0.8	1.5 3.5	2.0 4.0	mV mV (max) mV (max)
		$1\text{mA} \leq I_R 15\text{mA}$	8.0	12.0 23.0	18.0 29.0	mV mV (max) mV (max)
$Z_R$	Reverse Dynamic Impedance	$I_R = 1\text{mA}$ , $f = 120\text{Hz}$ $I_{AC} = 0.1 I_R$	0.7	1.7	2.3	$\Omega$ $\Omega$ (max)
$e_N$	Wideband Noise	$I_R = 150\mu\text{A}$ $10\text{Hz} \leq f \leq 10\text{kHz}$	180			$\mu\text{V}_{RMS}$
$\Delta V_R$	Reverse Breakdown Voltage Long Term Stability	$t = 1000\text{hrs}$ $T = 25^\circ\text{C} \pm 0.1^\circ\text{C}$ $I_R = 150\mu\text{A}$	120			ppm



# LM4040 Typical Characteristics

**Temperature Drift for Different Average Temperature Coefficient**

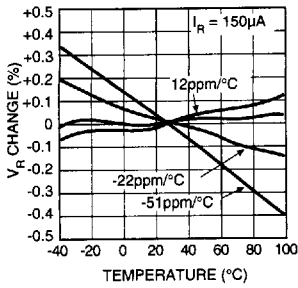

**Output Impedance vs. Frequency**

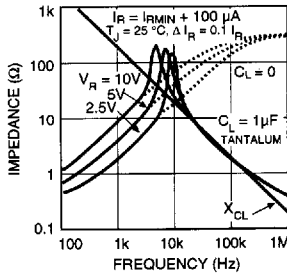

**Output Impedance vs. Frequency**

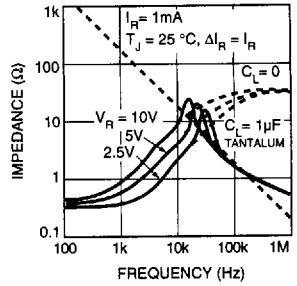

**Reverse Characteristics and Minimum Operating Current**

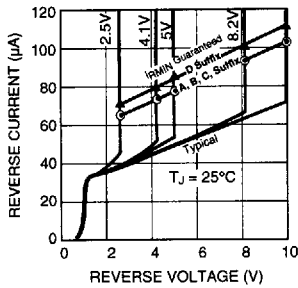

**Noise Voltage vs. Frequency**

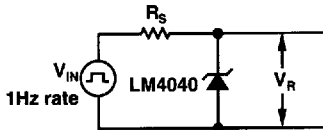
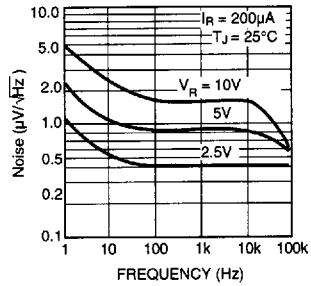

**Test Circuit**

**LM4040-2.5  $R_S = 30k$**

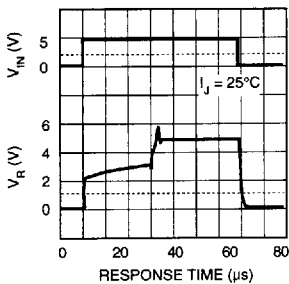

**LM4040-5.0  $R_S = 30k$**

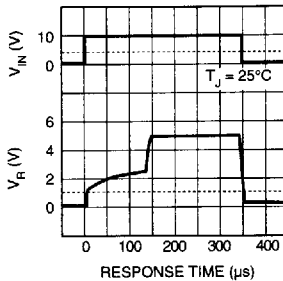

**LM4040-10.0  $R_S = 30k$**

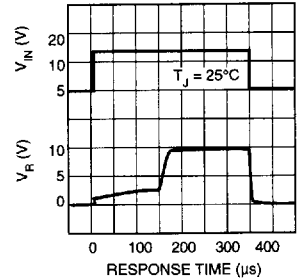

## LM4041-1.2 Electrical Characteristics

**Boldface limits apply for  $T_A = T_J = T_{MIN}$  to  $T_{MAX}$** ; all other limits  $T_A = T_J = 25^\circ\text{C}$ . The grades A, B, C, D, and E designate initial Reverse Breakdown Voltage tolerance of  $\pm 0.1\%$ ,  $\pm 0.2\%$ ,  $\pm 0.5\%$ ,  $\pm 1.0\%$ , and  $\pm 2.0$  respectively.

Symbol	Parameter	Conditions	Typical (Note 4)	LM4041AIM LM4041AIM3 LM4041AIZ Limits (Note 5)	LM4041BIM LM4041BIM3 LM4041BIZ Limits (Note 5)	LM4041CIM LM4041CIM3 LM4041CIZ Limits (Note 5)	Units (Limit)
$V_R$	Reverse Breakdown Voltage	$I_R = 100\mu\text{A}$	1.225				V
	Reverse Breakdown Voltage Tolerance	$I_R = 100\mu\text{A}$		$\pm 1.2$ <b><math>\pm 9.2</math></b>	$\pm 2.4$ <b><math>\pm 10.4</math></b>	$\pm 6$ <b><math>\pm 14</math></b>	mV (max) mV (max)
$I_{RMIN}$	Minimum Operating Current		45	60 <b>65</b>	60 <b>65</b>	60 <b>65</b>	$\mu\text{A}$ $\mu\text{A}$ (max) $\mu\text{A}$ (max)
$\Delta V_R/\Delta T$	Average Reverse Breakdown Voltage Temperature Coefficient	$I_R = 10\text{mA}$ $I_R = 1\text{mA}$ $I_R = 100\mu\text{A}$	20 15 15	$\pm 100$	$\pm 100$	$\pm 100$	ppm/ $^\circ\text{C}$ ppm/ $^\circ\text{C}$ (max) ppm/ $^\circ\text{C}$ (max)
$\Delta V_R/\Delta I_R$	Reverse Breakdown Voltage Change with Operating Current Change	$I_{RMIN} \leq I_R 1\text{mA}$	0.7	1.5 <b>2.0</b>	1.5 <b>2.0</b>	1.5 <b>2.0</b>	mV mV (max) mV (max)
		$1\text{mA} \leq I_R 15\text{mA}$	4.0	6.0 <b>8.0</b>	6.0 <b>8.0</b>	6.0 <b>8.0</b>	mV mV (max) mV (max)
$Z_R$	Reverse Dynamic Impedance	$I_R = 1\text{mA}$ , $f = 120\text{Hz}$ $I_{AC} = 0.1 I_R$	0.5	1.5	1.5	1.5	$\Omega$ $\Omega$ (max)
$e_N$	Wideband Noise	$I_R = 100\mu\text{A}$ $10\text{Hz} \leq f \leq 10\text{kHz}$	20				$\mu\text{V}_{RMS}$
$\Delta V_R$	Reverse Breakdown Voltage Long Term Stability	$t = 1000\text{hrs}$ $T = 25^\circ\text{C} \pm 0.1^\circ\text{C}$ $I_R = 100\mu\text{A}$	120				ppm

Symbol	Parameter	Conditions	Typical (Note 4)	LM4041DIM LM4041DIM3 LM4041DIZ Limits (Note 5)	LM4041EIM3 LM4041EIZ Limits (Note 5)	Units (Limit)
$V_R$	Reverse Breakdown Voltage	$I_R = 100\mu\text{A}$	1.225			V
	Reverse Breakdown Voltage Tolerance	$I_R = 100\mu\text{A}$		$\pm 12$ <b><math>\pm 24</math></b>	$\pm 25$ <b><math>\pm 36</math></b>	mV (max) mV (max)
$I_{RMIN}$	Minimum Operating Current		45	65 <b>70</b>	65 <b>70</b>	$\mu\text{A}$ $\mu\text{A}$ (max) $\mu\text{A}$ (max)
$\Delta V_R/\Delta T$	Average Reverse Breakdown Voltage Temperature Coefficient	$I_R = 10\text{mA}$ $I_R = 1\text{mA}$ $I_R = 100\mu\text{A}$	20 15 15	$\pm 150$	$\pm 150$	ppm/ $^\circ\text{C}$ ppm/ $^\circ\text{C}$ (max) ppm/ $^\circ\text{C}$ (max)
$\Delta V_R/\Delta I_R$	Reverse Breakdown Voltage Change with Operating Current Change	$I_{RMIN} \leq I_R 1\text{mA}$	0.3	2.0 <b>2.5</b>	2.0 <b>2.5</b>	mV mV (max) mV (max)
		$1\text{mA} \leq I_R 15\text{mA}$	2.5	8.0 <b>10.0</b>	8.0 <b>10.0</b>	mV mV (max) mV (max)
$Z_R$	Reverse Dynamic Impedance	$I_R = 1\text{mA}$ , $f = 120\text{Hz}$ $I_{AC} = 0.1 I_R$	0.3	2.0	2.0	$\Omega$ $\Omega$ (max)
$e_N$	Wideband Noise	$I_R = 100\mu\text{A}$ $10\text{Hz} \leq f \leq 10\text{kHz}$	35			$\mu\text{V}_{RMS}$
$\Delta V_R$	Reverse Breakdown Voltage Long Term Stability	$t = 1000\text{hrs}$ $T = 25^\circ\text{C} \pm 0.1^\circ\text{C}$ $I_R = 100\mu\text{A}$	120			ppm

## LM4041-Adjustable Electrical Characteristics

**Boldface limits apply for  $T_A = T_J = T_{MIN}$  to  $T_{MAX}$** ; all other limits  $T_J = 25^\circ\text{C}$  unless otherwise specified (SOT-23, see Note 7),  $I_{RMIN} \leq I_R < 12\text{mA}$ ,  $V_{REF} \leq V_{OUT} \leq 10\text{V}$ . The grades C and D designate initial Reverse Breakdown Voltage tolerance of  $\pm 0.5\%$  and  $\pm 1\%$ , respectively for  $V_{OUT} = 5\text{V}$ .

Symbol	Parameter	Conditions	Typical (Note 4)	LM4041CIM LM4041CIM3 LM4041CIZ Limits (Note 5)	LM4041DIM LM4041DIM3 LM4041DIZ Limits (Note 5)	Units (Limit)
$V_{REF}$	Reference Breakdown Voltage	$I_R = 100\mu\text{A}$ $V_{OUT} = 5\text{V}$	1.233			V
	Reference Breakdown Voltage Tolerance (Note 8)	$I_R = 100\mu\text{A}$		$\pm 6.2$ $\pm 14$	$\pm 12$ $\pm 24$	mV (max) mV (max)
$I_{RMIN}$	Minimum Operating Current		45	60	65	$\mu\text{A}$ $\mu\text{A}$ (max) $\mu\text{A}$ (max)
				<b>65</b>	<b>70</b>	
$\Delta V_{REF} / \Delta I_R$	Reference Voltage Change with Operating Current Change	$I_{RMIN} \leq I_R 1\text{mA}$ SOT-23: $V_{OUT} \geq 1.6\text{V}$ (Note 7)	0.7	1.5 <b>2.0</b>	2.0 <b>2.5</b>	mV mV (max) mV (max)
		$1\text{mA} \leq I_R 15\text{mA}$ SOT-23: $V_{OUT} \geq 1.6\text{V}$ (Note 7)	2	4 <b>6</b>	6 <b>8</b>	mV mV (max) mV (max)
$\Delta V_{REF} / \Delta V_O$	Reference Voltage Change with Output Voltage Change	$I_R = 1\text{mA}$	-1.3	-2.0 <b>-2.5</b>	-2.5 <b>-3.0</b>	mV/V mV/V (max) mV/V (max)
$I_{FB}$	Feedback Current		60	<b>100</b> <b>120</b>	<b>150</b> <b>200</b>	nA nA (max) nA (max)
$\Delta V_{REF} / \Delta T$	Average Reference Voltage Temperature Coefficient (Note 8)	$V_{OUT} = 5\text{V}$ $I_R = 10\text{mA}$ $I_R = 1\text{mA}$ $I_R = 100\mu\text{A}$	20	$\pm 100$	$\pm 150$	ppm/ $^\circ\text{C}$ ppm/ $^\circ\text{C}$ (max) ppm/ $^\circ\text{C}$ (max)
			15			
			15			
			15			
$Z_{OUT}$	Dynamic Output Impedance	$I_R = 1\text{mA}$ , $f = 120\text{Hz}$ $I_{AC} = 0.1 I_R$ $V_{OUT} = V_{REF}$ $V_{OUT} = 10\text{V}$	0.3			$\Omega$ $\Omega$ (max)
			2			
$e_N$	Wideband Noise	$I_R = 100\mu\text{A}$ $10\text{Hz} \leq f \leq 10\text{kHz}$	20			$\mu\text{V}_{RMS}$
$\Delta V_{REF}$	Reference Voltage Long Term Stability	$t = 1000\text{hrs}$ $T = 25^\circ\text{C} \pm 0.1^\circ\text{C}$ $I_R = 100\mu\text{A}$	120			ppm

## LM4040 and LM4041 Electrical Characteristic Notes

- Note 1** Absolute Maximum Ratings indicate limits beyond which damage to the device may occur. Operating Ratings indicate conditions for which the device is functional, but do not guarantee specific performance limits. For guaranteed specification and test conditions, see the Electrical Characteristics. The guaranteed specifications apply only for the test conditions listed. Some performance characteristics may degrade when the device is not operated under the listed test conditions.
- Note 2** The maximum power dissipation must be derated at elevated temperatures and is dictated by  $T_{JMAX}$  (maximum junction temperature),  $\theta_{JA}$  (junction to ambient thermal resistance), and  $T_A$  (ambient temperature). The maximum allowable power dissipation at any temperature is  $P_{DMAX} = (T_{JMAX} - T_A)/\theta_{JA}$  or the number given in the Absolute Maximum Ratings, whichever is lower. For the LM4040 and LM4041,  $T_{JMAX} = 125^\circ\text{C}$ , and the typical thermal resistance ( $\theta_{JA}$ ), when board mounted, is  $185^\circ\text{C/W}$  for the M package,  $326^\circ\text{C/W}$  for the SOT-23 package, and  $180^\circ\text{C/W}$  with  $0.4''$  lead length and  $170^\circ\text{C/W}$  with  $0.125''$  lead length for the TO-92 package.
- Note 3** The human body model is a  $100\text{pF}$  capacitor discharged through a  $1.5\text{k}\Omega$  resistor into each pin. The machine model is a  $200\text{pF}$  capacitor discharged directly into each pin.
- Note 4** Typicals are at  $T_J = 25^\circ\text{C}$  and represent most likely parametric norm.
- Note 5** Limits are 100% production tested at  $25^\circ\text{C}$ . Limits over temperature are guaranteed through correlation using Statistical Quality Control (SQL) methods.
- Note 6** The boldface (over temperature limit for Reverse Breakdown Voltage Tolerance is defined as the room temperature Reverse Breakdown Voltage Tolerance  $\{[\Delta V_R/\Delta T](65^\circ\text{C})\}(V_R)$ .  $\Delta V_R/\Delta T$  is the  $V_R$  temperature coefficient,  $65^\circ\text{C}$  is the temperature range from  $-40^\circ\text{C}$  to the reference point of  $25^\circ\text{C}$ , and  $V_R$  is the reverse breakdown voltage. The total over temperature tolerance for the different grades follows:  
 A-grade:  $\pm 0.75\% = \pm 0.1\% \pm 100\text{ppm}/^\circ\text{C} \times 65^\circ\text{C}$   
 B-grade:  $\pm 0.85\% = \pm 0.2\% \pm 100\text{ppm}/^\circ\text{C} \times 65^\circ\text{C}$   
 C-grade:  $\pm 1.15\% = \pm 0.5\% \pm 100\text{ppm}/^\circ\text{C} \times 65^\circ\text{C}$   
 D-grade:  $\pm 1.98\% = \pm 1.0\% \pm 150\text{ppm}/^\circ\text{C} \times 65^\circ\text{C}$   
 E-grade:  $\pm 2.98\% = \pm 1.0\% \pm 150\text{ppm}/^\circ\text{C} \times 65^\circ\text{C}$   
 Example: The A-grade LM4040-2.5 has an over temperature Reverse Breakdown Voltage tolerance of  $\pm 2.5 \times 0.75\% = \pm 19\text{mV}$ .
- Note 7** When  $V_{OUT} \leq 1.6\text{V}$ , the LM4041-ADJ in the SOT-23 package must operate at reduced  $I_R$ . This is caused by the series resistance of the die attach between the die (-) output and the package (-) output pin. See the Output Saturation (SOT-23 only) curve in the Typical Performance Characteristics section.
- Note 8** Reference voltage and temperature coefficient will change with output voltage. See Typical Performance Characteristics curves.

## LM4041 Typical Characteristics

Temperature Drift for Different Average Temperature Coefficient

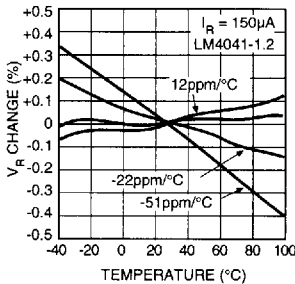

Output Impedance vs. Frequency

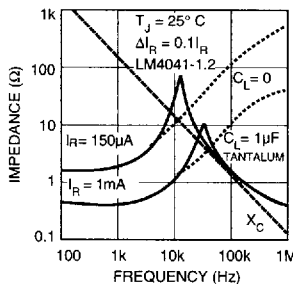

Voltage Impedance

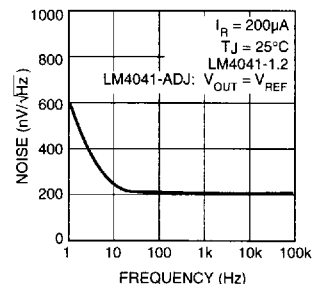

Reverse Characteristics and Minimum Operating Current

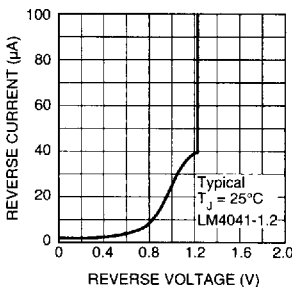

Reverse Characteristics and Minimum Operating Current

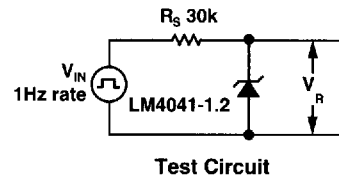
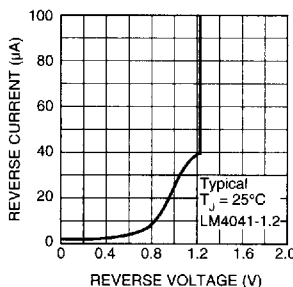

10

# LM4041 Typical Characteristics

**Reference Voltage vs. Output Voltage and Temperature**

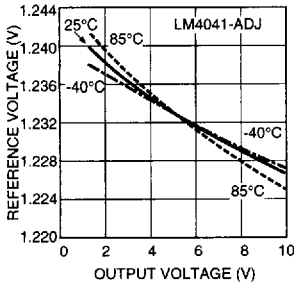

**Reference Voltage vs. Temperature and Output Voltage**

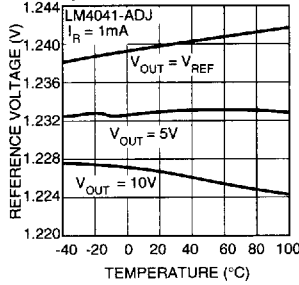

**Feedback Current vs. Output Voltage and Temperature**

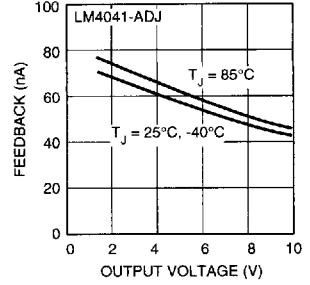

**Output Saturation (SOT-23 Only)**

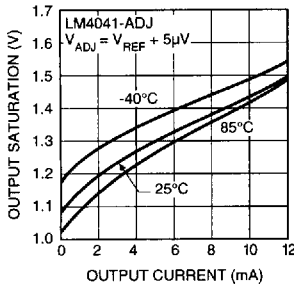

**Output Impedance vs. Frequency \***

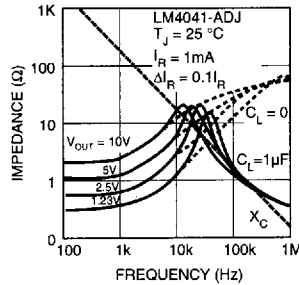

**Output Impedance vs. Frequency \***

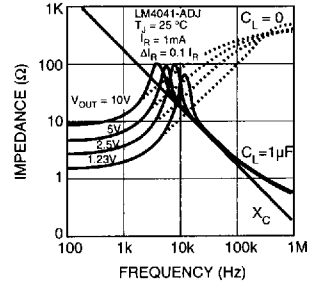

**Reverse Characteristics †**

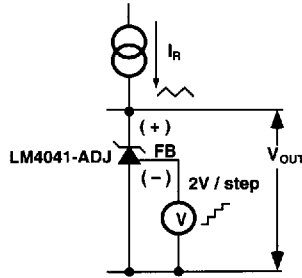
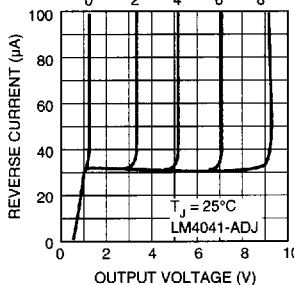

**† Reverse Characteristics Test Circuit**

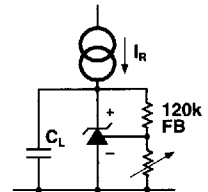

**\* Output Impedance vs. Freq. Test Circuit**

**Large Signal Response †**

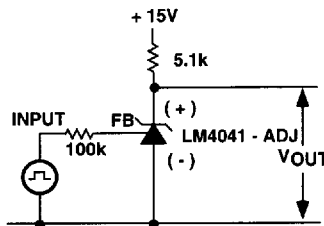
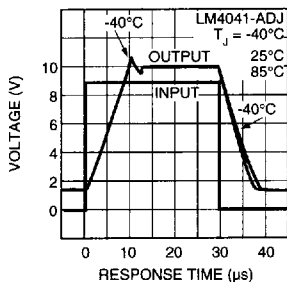

**† Large Signal Response Test Circuit**

maximum value. When the supply voltage is at its maximum and  $I_L$  is at its minimum,  $R_S$  should be large enough so that the current flowing through the LM4040-x.x is less than 15mA, and the current flowing through the LM4041-1.2 or LM4041-ADJ is less than 12mA.

$R_S$  is determined by the supply voltage ( $V_S$ ), the load and operating current, ( $I_L$  and  $I_Q$ ), and the reference's reverse breakdown voltage ( $V_R$ ).

$$R_S = (V_S - V_R) / (I_L + I_Q)$$

**Adjustable Regulator**

The LM4041-ADJ's output voltage can be adjusted to any value in the range of 1.24V through 10V. It is a function of the internal reference voltage ( $V_{REF}$ ) and the ratio of the external feedback resistors as shown in Figure 2. The output is found using the equation

$$(1) \quad V_O = V_{REF} \cdot [(R2/R1) + 1]$$

where  $V_O$  is the desired output voltage. The actual value of the internal  $V_{REF}$  is a function of  $V_O$ . The "corrected"  $V_{REF}$  is determined by

$$(2) \quad V_{REF}' = V_O (\Delta V_{REF} / \Delta V_O) = V_Y$$

where  $V_O$  is the desired output voltage.  $\Delta V_{REF} / \Delta V_O$  is found in the Electrical Characteristics and is typically  $-1.3mV/V$  and  $V_Y$  is equal to 1.240V. Replace the value of  $V_{REF}'$  in equation (1) with the value found using equation (2).

Note that actual output voltage can deviate from that predicted using the typical  $\Delta V_{REF} / \Delta V_O$  in equation (2); for C-grade parts, the worst-case  $\Delta V_{REF} / \Delta V_O$  is  $-2.5mV/V$  and  $V_Y = 1.248V$ .

The following example shows the difference in output voltage resulting from the typical and worst case values of  $\Delta V_{REF} / \Delta V_O$ :

Let  $V_O = +9V$ . Using the typical values of  $\Delta V_{REF} / \Delta V_O$ ,  $V_{REF}$  is 1.228V. Choosing a value of  $R1 = 10k\Omega$ ,  $R2 = 63.272k\Omega$ . Using the worst case  $\Delta V_{REF} / \Delta V_O$  for the C-grade and D-grade parts, the output voltage is actually 8.965V and 8.946V respectively. This results in possible errors as large as 0.39% for the C-grade parts and 0.59% for the D-grade parts. Once again, resistor values found using the typical value of  $\Delta V_{REF} / \Delta V_O$  will work in most cases, requiring no further adjustment.

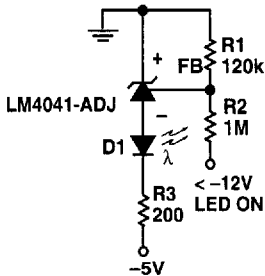

Figure 3. Voltage Level Detector

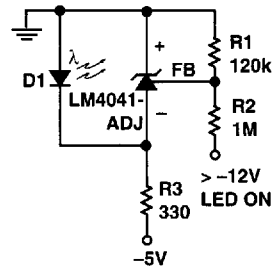

Figure 4. Voltage Level Detector

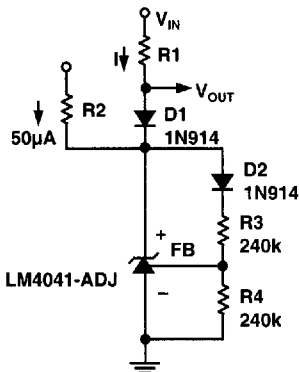

Figure 5. Fast Positive Clamp  
 $2.4V + \Delta V_{D1}$

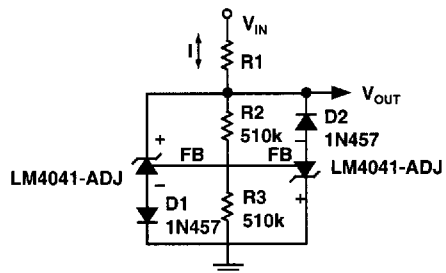

Figure 6. Bidirectional Clamp  
 $\pm 2.4V$

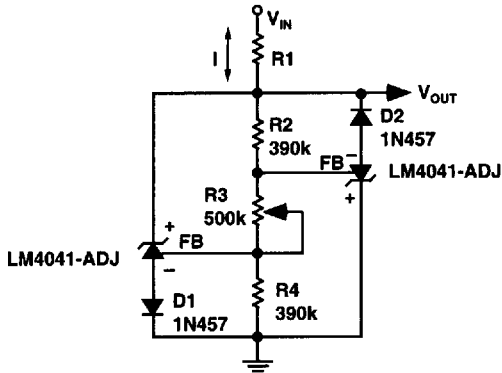

Figure 7. Bidirectional Adjustable Clamp  
±18V to ±2.4V

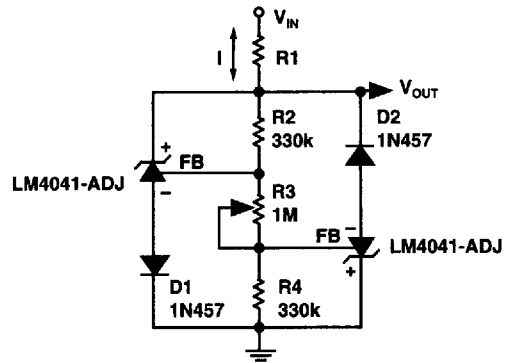

Figure 8. Bidirectional Adjustable Clamp  
±2.4 to ±6V

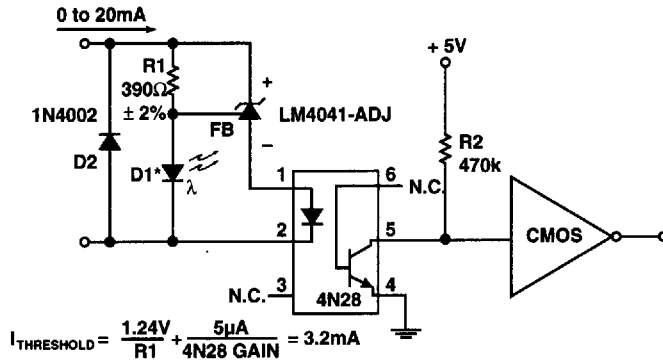

Figure 9. Floating Current Detector

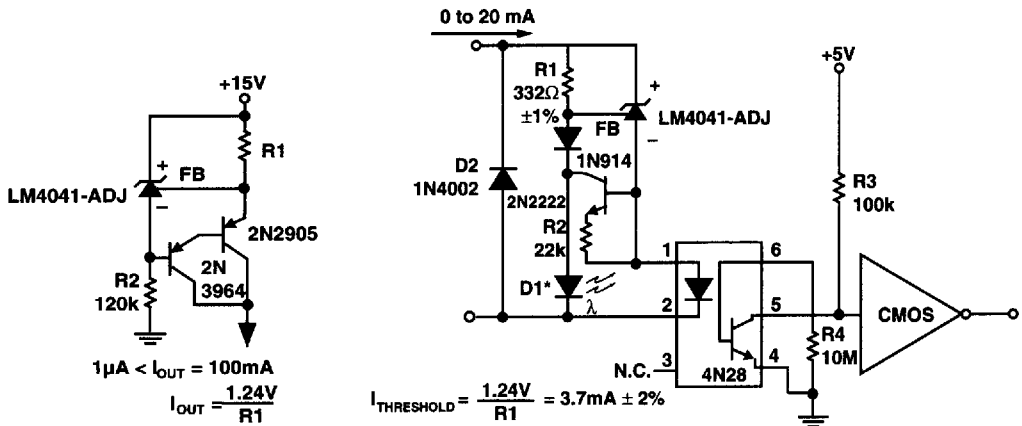

Figure 10. Current Source

Figure 11. Precision Floating Current Detector

\* D1 can be any LED,  $V_F = 1.5\text{V to } 2.2\text{V}$  at  $3\text{mA}$ . D1 may act as an indicator. D1 will be on if  $I_{\text{THRESHOLD}}$  falls below the threshold current, except with  $I = 0$ .