

RFD16N02L, RFD16N02LSM

16A, 20V, 0.022Ω, N-Channel
Logic Level Power MOSFET

May 1997

Features

- 16A, 20V
- $r_{DS(ON)} = 0.022\Omega$
- *Temperature Compensating* PSPICE Model
- Can be Driven Directly from CMOS, NMOS, and TTL Circuits
- Peak Current vs Pulse Width Curve
- UIS Rating Curve
- 175°C Operating Temperature

Ordering Information

PART NUMBER	PACKAGE	BRAND
RFD16N02L	TO-251AA	16N02L
RFD16N02LSM	TO-252AA	16N02L

NOTE: When ordering, use the entire part number. Add the suffix 9A, to obtain the TO-252AA variant in tape and reel, e.g. RFD16N02LSM9A.

Formerly developmental type TA49243.

Description

The RFD16N02L and RFD16N02LSM are N-Channel power MOSFETs manufactured using the MegaFET process. This process, which uses feature sizes approaching those of LSI circuits, gives optimum utilization of silicon, resulting in outstanding performance. They were designed for use in applications such as switching regulators, switching converters, motor drivers and relay drivers. This performance is accomplished through a special gate oxide design which provides full rated conductance at gate bias in the 3V to 5V range, thereby facilitating true on-off power control directly from logic level (5V) integrated circuits.

Symbol

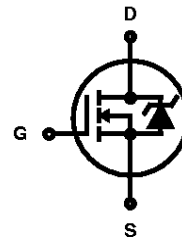

Packaging

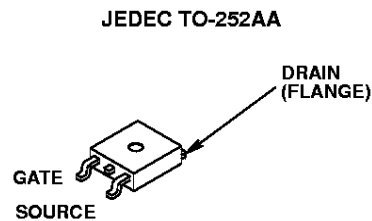
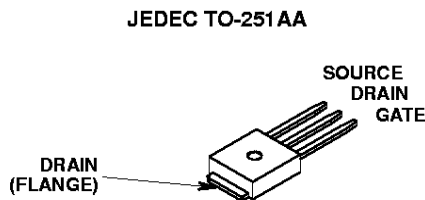

RFD16N02L, RFD16N02LSM

Absolute Maximum Ratings $T_C = 25^\circ\text{C}$

	RFD16N02L, RFD16N02LSM	UNITS
Drain to Source Voltage	20	V
Drain to Gate Voltage	20	V
Gate to Source Voltage	± 10	V
Drain Current		
RMS Continuous	16	A
Pulsed Drain Current	Refer to Peak Current Curve	
Pulsed Avalanche Rating	Refer to UIS Curve	
Power Dissipation	90	W
Derate Above 25°C	0.606	W/ $^\circ\text{C}$
Operating and Storage Temperature	-55 to 175	$^\circ\text{C}$
Soldering Temperature of Leads for 10s	260	$^\circ\text{C}$

CAUTION: Stresses above those listed in "Absolute Maximum Ratings" may cause permanent damage to the device. This is a stress only rating and operation of the device at these or any other conditions above those indicated in the operational sections of this specification is not implied.

Electrical Specifications $T_C = 25^\circ\text{C}$, Unless Otherwise Specified

PARAMETER	SYMBOL	TEST CONDITIONS	MIN	TYP	MAX	UNITS	
Drain to Source Breakdown Voltage	BV_{DSS}	$I_D = 250\mu\text{A}$, $V_{GS} = 0\text{V}$	20	-	-	V	
Gate to Source Threshold Voltage	$V_{GS(TH)}$	$V_{GS} = V_{DS}$, $I_D = 250\mu\text{A}$	1	-	2	V	
Zero Gate Voltage Drain Current	I_{DSS}	$V_{DS} = 20\text{V}$, $V_{GS} = 0\text{V}$	$T_C = 25^\circ\text{C}$	-	-	1	μA
			$T_C = 150^\circ\text{C}$	-	-	50	μA
Gate to Source Leakage Current	I_{GSS}	$V_{GS} = \pm 10\text{V}$	-	-	± 100	nA	
Drain to Source On Resistance	$r_{DS(ON)}$	$I_D = 16\text{A}$, $V_{GS} = 5\text{V}$	-	-	0.022	Ω	
Turn-On Time	t_{ON}	$V_{DD} = 15\text{V}$, $I_D \cong 16\text{A}$, $R_L = 0.93\Omega$, $V_{GS} = 5\text{V}$, $R_{GS} = 5\Omega$	-	-	120	ns	
Turn-On Delay Time	$t_{d(ON)}$		-	15	-	ns	
Rise Time	t_r		-	95	-	ns	
Turn-Off Delay Time	$t_{d(OFF)}$		-	25	-	ns	
Fall Time	t_f		-	27	-	ns	
Turn-Off Time	t_{OFF}		-	-	80	ns	
Total Gate Charge	$Q_g(TOT)$	$V_{GS} = 0\text{V}$ to 10V	$V_{DD} \cong 16\text{V}$, $I_D \cong 16\text{A}$, $R_L = 1.0\Omega$	-	50	60	nC
Gate Charge at 5V	$Q_g(5)$	$V_{GS} = 0\text{V}$ to 5V		-	30	36	nC
Threshold Gate Charge	$Q_g(TH)$	$V_{GS} = 0\text{V}$ to 1V		-	1.5	1.8	nC
Input Capacitance	C_{ISS}	$V_{DS} = 20\text{V}$, $V_{GS} = 0\text{V}$, $f = 1\text{MHz}$	-	1300	-	pF	
Output Capacitance	C_{OSS}		-	724	-	pF	
Reverse Transfer Capacitance	C_{RSS}		-	250	-	pF	
Thermal Resistance Junction to Case	$R_{\theta JC}$		-	-	1.65	$^\circ\text{C/W}$	
Thermal Resistance Junction to Ambient	$R_{\theta JA}$	TO-251 and TO-252	-	-	100	$^\circ\text{C/W}$	

Source to Drain Diode Specifications

PARAMETER	SYMBOL	TEST CONDITIONS	MIN	TYP	MAX	UNITS
Source to Drain Diode Voltage	V_{SD}	$I_{SD} = 16\text{A}$	-	-	1.5	V
Reverse Recovery Time	t_{rr}	$I_{SD} = 16\text{A}$, $dI_{SD}/dt = 100\text{A}/\mu\text{s}$	-	-	80	ns

Typical Performance Curves

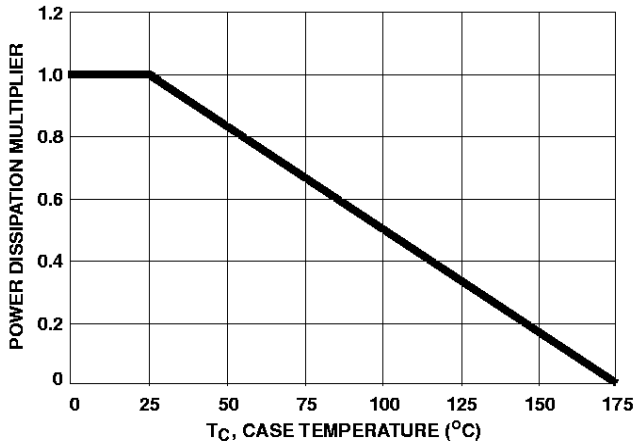

FIGURE 1. NORMALIZED POWER DISSIPATION vs TEMPERATURE DERATING

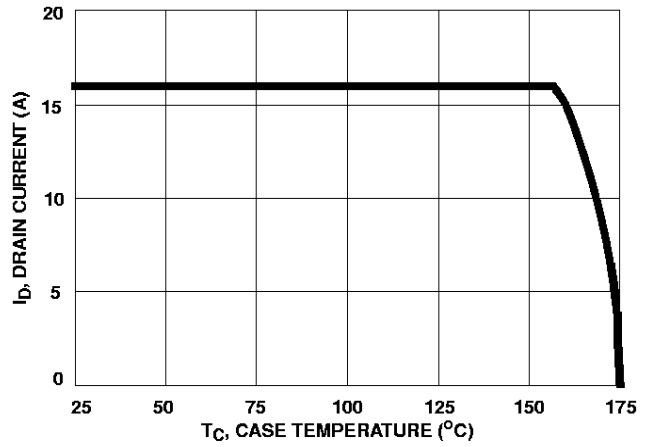

FIGURE 2. MAXIMUM CONTINUOUS DRAIN CURRENT vs CASE TEMPERATURE

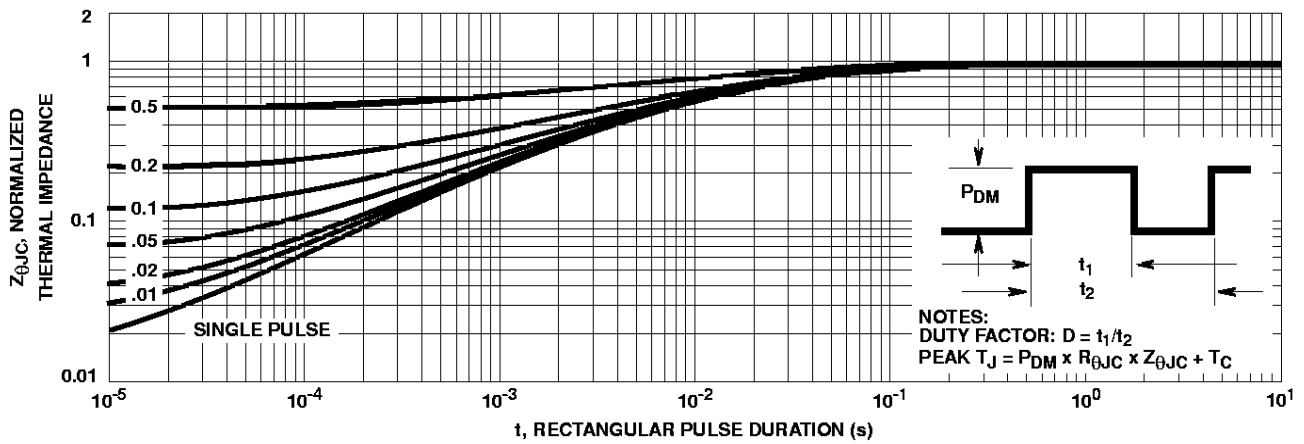

FIGURE 3. NORMALIZED MAXIMUM TRANSIENT THERMAL IMPEDANCE

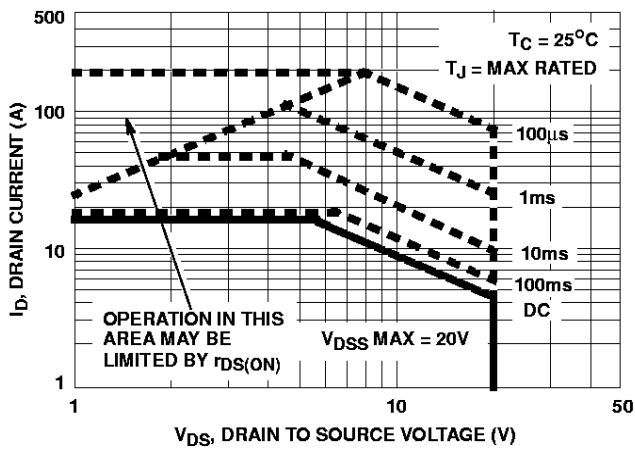

FIGURE 4. FORWARD BIAS SAFE OPERATING AREA

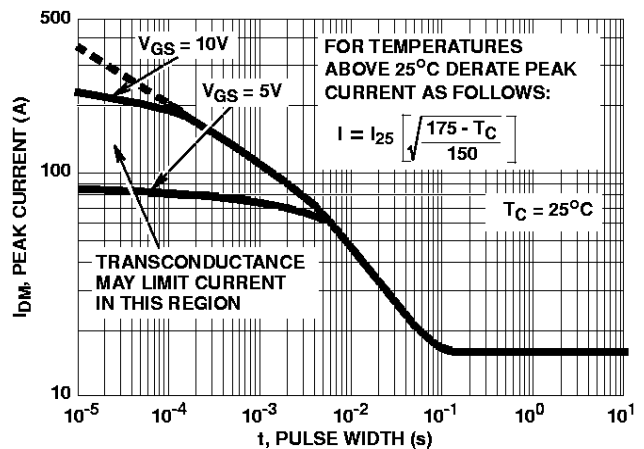
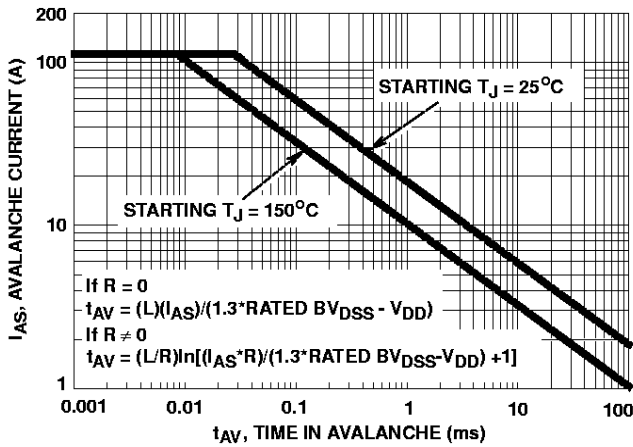

FIGURE 5. PEAK CURRENT CAPABILITY

Typical Performance Curves (Continued)



NOTE: Refer to Harris Application Notes AN9321 and AN9322.

FIGURE 6. UNCLAMPED INDUCTIVE SWITCHING

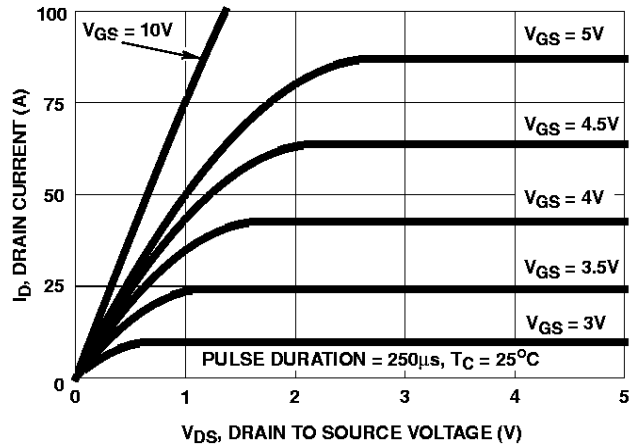

FIGURE 7. SATURATION CHARACTERISTICS

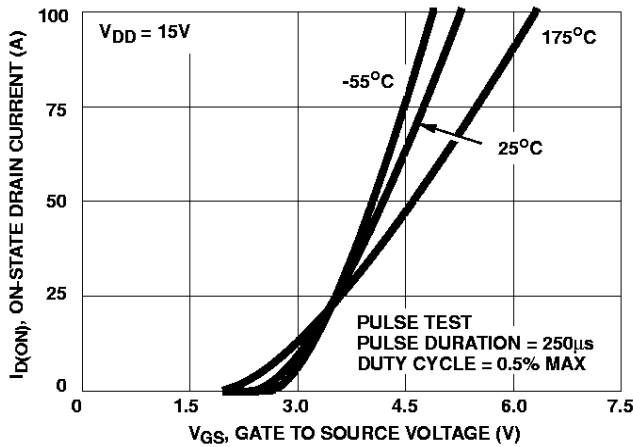

FIGURE 8. TRANSFER CHARACTERISTICS

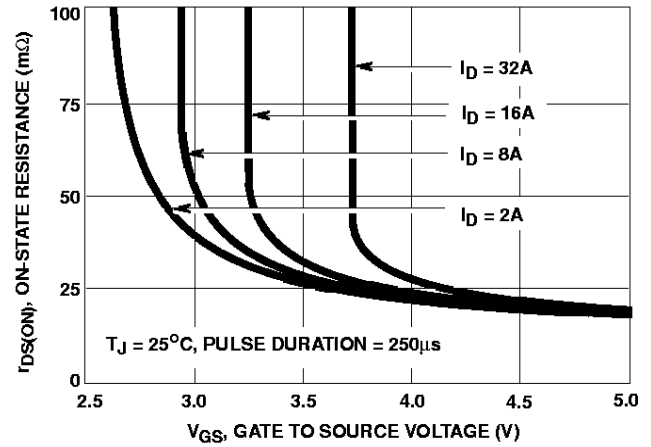

FIGURE 9. DRAIN TO SOURCE ON RESISTANCE vs GATE VOLTAGE AND DRAIN CURRENT

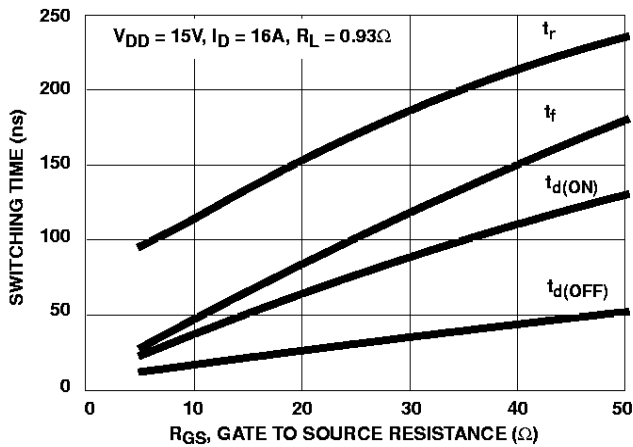

FIGURE 10. SWITCHING TIME AS A FUNCTION OF GATE RESISTANCE

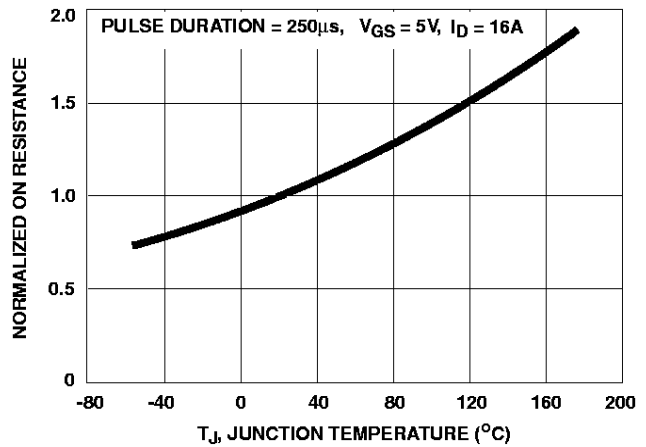

FIGURE 11. NORMALIZED DRAIN TO SOURCE ON RESISTANCE vs JUNCTION TEMPERATURE

Typical Performance Curves (Continued)

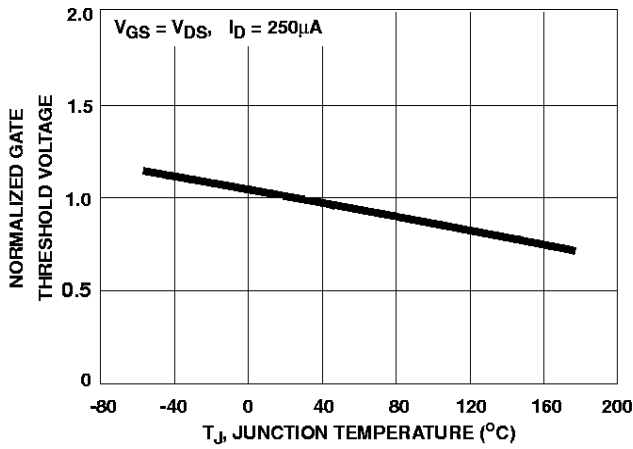

FIGURE 12. NORMALIZED GATE THRESHOLD VOLTAGE vs JUNCTION TEMPERATURE

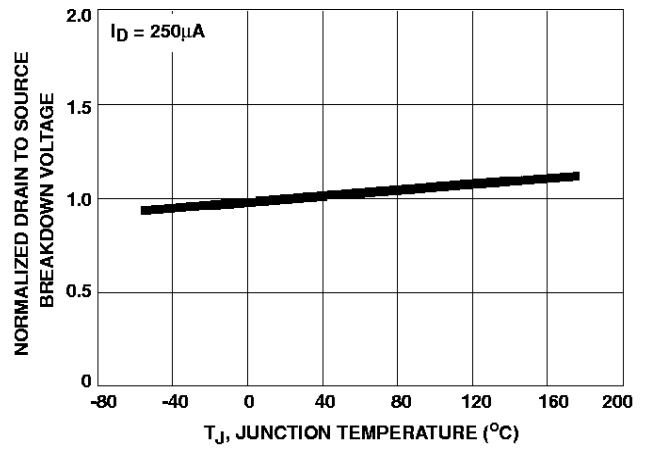

FIGURE 13. NORMALIZED DRAIN TO SOURCE BREAKDOWN VOLTAGE vs JUNCTION TEMPERATURE

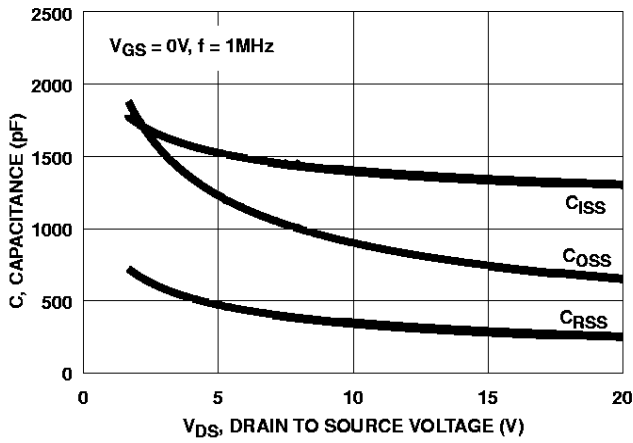
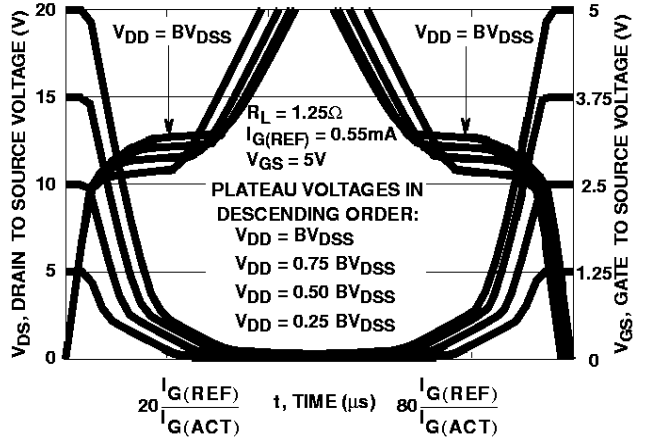

FIGURE 14. CAPACITANCE vs DRAIN TO SOURCE VOLTAGE



NOTE: Refer to Application Notes AN7254 and AN7260.

FIGURE 15. NORMALIZED SWITCHING WAVEFORMS FOR CONSTANT GATE CURRENT

Test Circuits and Waveforms

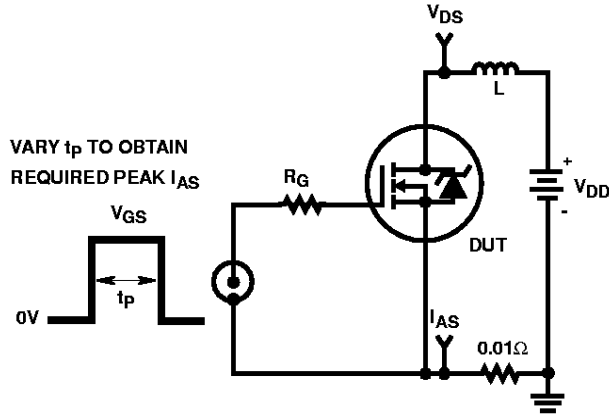

FIGURE 16. UNCLAMPED ENERGY TEST CIRCUIT

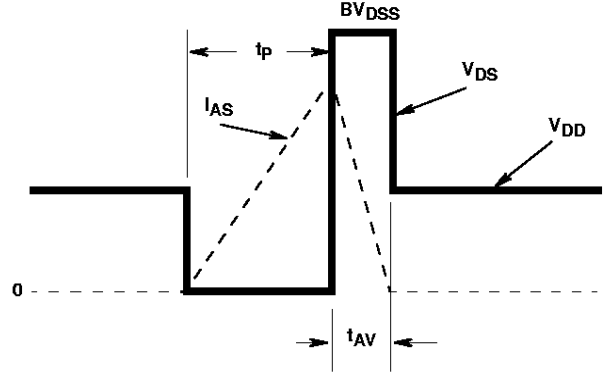

FIGURE 17. UNCLAMPED ENERGY WAVEFORMS

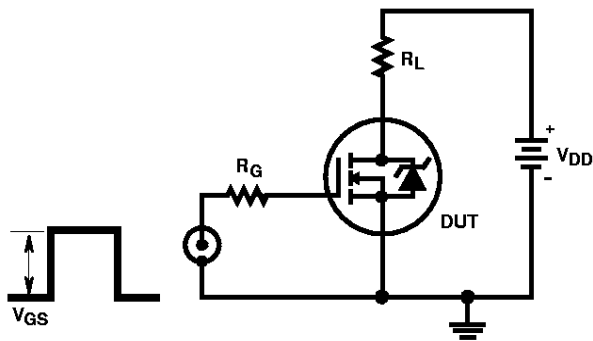

FIGURE 18. SWITCHING TIME TEST CIRCUIT

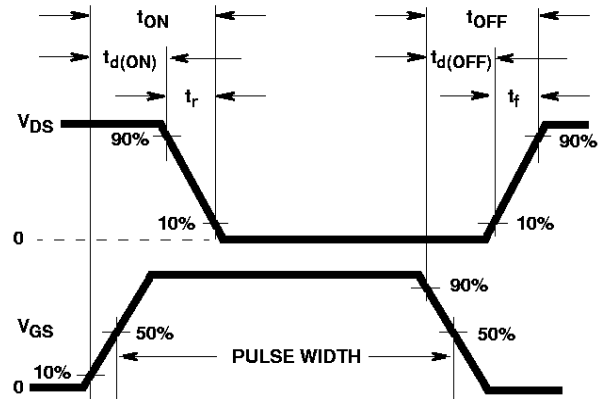

FIGURE 19. RESISTIVE SWITCHING WAVEFORMS

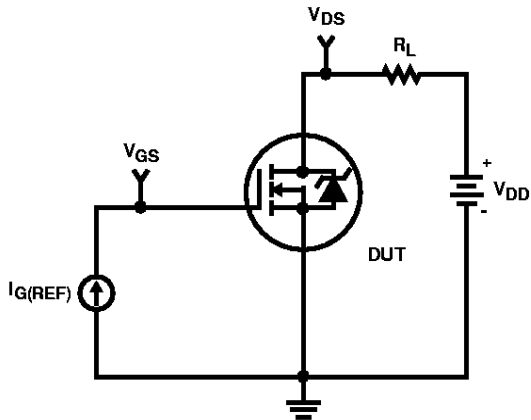

FIGURE 20. GATE CHARGE TEST CIRCUIT

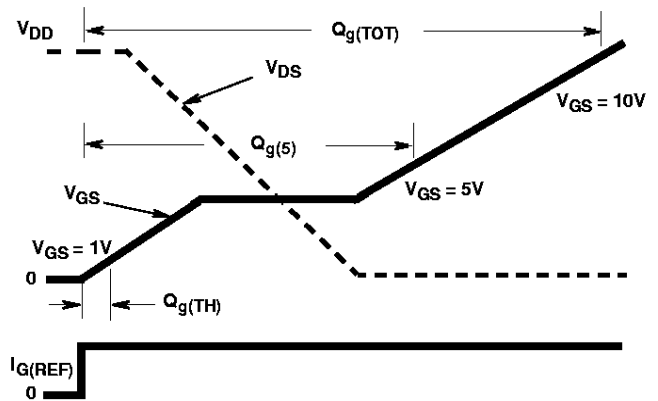

FIGURE 21. GATE CHARGE WAVEFORMS

RFD16N02L, RFD16N02LSM

Temperature Compensated PSPICE Model for the RFD16N02L, RFD16N02LSM

.SUBCKT RFD16N02L 2 1 3; rev 12/12/94

CA 12 8 2.55e-9

CB 15 14 2.64e-9

CIN 6 8 1.05e-9

DBODY 7 5 DBDMOD

DBREAK 5 11 DBKMOD

DPLCAP 10 5 DPLCAPMOD

EBREAK 11 7 17 18 33.3

EDS 14 8 5 8 1

EGS 13 8 6 8 1

ESG 6 10 6 8 1

EVTO 20 6 18 8 1

IT 8 17 1

LDRAIN 2 5 1e-9

LGATE 1 9 3.4e-9

LSOURCE 3 7 3.4e-9

MOS1 16 6 8 8 MOSMOD M = 0.99

MOS2 16 21 8 8 MOSMOD M = 0.01

RBREAK 17 18 RBKMOD 1

RDRAIN 50 16 RDSMOD 0.14e-3

RGATE 9 20 0.89

RIN 6 8 1e9

RSCL1 5 51 RSCLMOD 1e-6

RSCL2 5 50 1e3

RSOURCE 8 7 RDSMOD 10.31e-3

RVTO 18 19 RVTOMOD 1

S1A 6 12 13 8 S1AMOD

S1B 13 12 13 8 S1BMOD

S2A 6 15 14 13 S2AMOD

S2B 13 15 14 13 S2BMOD

VBAT 8 19 DC 1

VTO 21 6 0.583

ESCL 51 50 VALUE = {(V(5,51)/ABS(V(5,51)))*(PWR(V(5,51)*1e6/176,6))}

.MODEL DBDMOD D (IS = 3.61e-13 RS = 5.06e-3 TRS1 = 3.05e-3 TRS2 = 7.57e-6 CJO = 2.0e-9 TT = 2.18e-8)

.MODEL DBKMOD D (RS = 1.66e-1 TRS1 = -2.97e-3 TRS2 = 7.57e-6)

.MODEL DPLCAPMOD D (CJO = 1.25e-9 IS = 1e-30 N = 10)

.MODEL MOSMOD NMOS (VTO = 2.313 KP = 53.82 IS = 1e-30 N = 10 TOX = 1 L = 1u W = 1u)

.MODEL RBKMOD RES (TC1 = 8.95e-4 TC2 = -1e-7)

.MODEL RDSMOD RES (TC1 = 3.92e-3 TC2 = 1.29e-5)

.MODEL RSCLMOD RES (TC1 = 2.03e-3 TC2 = 0.45e-5)

.MODEL RVTOMOD RES (TC1 = -2.27e-3 TC2 = -5.75e-7)

.MODEL S1AMOD VSWITCH (RON = 1e-5 ROFF = 0.1 VON = -4.82 VOFF = -2.82)

.MODEL S1BMOD VSWITCH (RON = 1e-5 ROFF = 0.1 VON = -2.82 VOFF = -4.82)

.MODEL S2AMOD VSWITCH (RON = 1e-5 ROFF = 0.1 VON = -2.67 VOFF = 2.33)

.MODEL S2BMOD VSWITCH (RON = 1e-5 ROFF = 0.1 VON = 2.33 VOFF = -2.67)

.ENDS

NOTE: For further discussion of the PSPICE model, consult **A New PSPICE Sub-Circuit for the Power MOSFET Featuring Global Temperature Options**; written by William J. Hepp and C. Frank Wheatley.

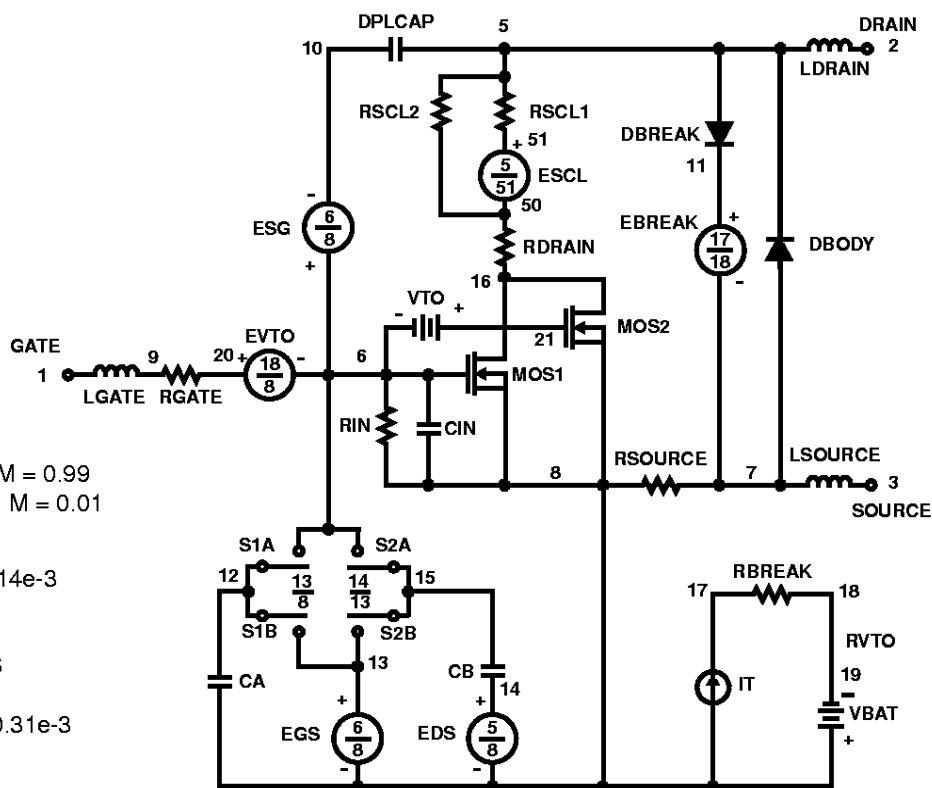

RFD16N02L, RFD16N02LSM

TO-251AA

3 LEAD JEDEC TO-251AA PLASTIC PACKAGE

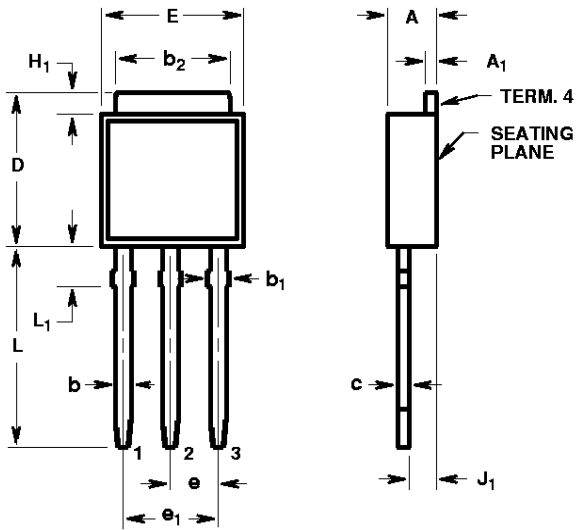

SYMBOL	INCHES		MILLIMETERS		NOTES
	MIN	MAX	MIN	MAX	
A	0.086	0.094	2.19	2.38	-
A ₁	0.018	0.022	0.46	0.55	3, 4
b	0.028	0.032	0.72	0.81	3, 4
b ₁	0.033	0.040	0.84	1.01	3
b ₂	0.205	0.215	5.21	5.46	3, 4
c	0.018	0.022	0.46	0.55	3, 4
D	0.270	0.290	6.86	7.36	-
E	0.250	0.265	6.35	6.73	-
e	0.090 TYP		2.28 TYP		5
e ₁	0.180 BSC		4.57 BSC		5
H ₁	0.035	0.045	0.89	1.14	-
J ₁	0.040	0.045	1.02	1.14	6
L	0.355	0.375	9.02	9.52	-
L ₁	0.075	0.090	1.91	2.28	2

NOTES:

1. These dimensions are within allowable dimensions of Rev. C of JEDEC TO-251AA outline dated 9-88.
2. Solder finish uncontrolled in this area.
3. Dimension (without solder).
4. Add typically 0.002 inches (0.05mm) for solder plating.
5. Position of lead to be measured 0.250 inches (6.35mm) from bottom of dimension D.
6. Position of lead to be measured 0.100 inches (2.54mm) from bottom of dimension D.
7. Controlling dimension: Inch.
8. Revision 2 dated 10-95.

RFD16N02L, RFD16N02LSM

TO-252AA

SURFACE MOUNT JEDEC TO-252AA PLASTIC PACKAGE

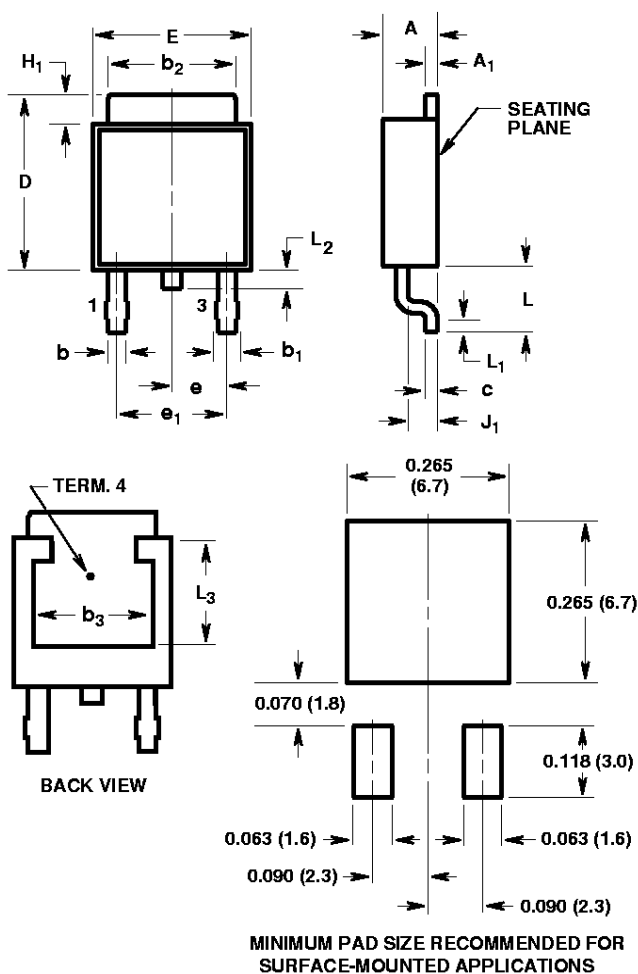

SYMBOL	INCHES		MILLIMETERS		NOTES
	MIN	MAX	MIN	MAX	
A	0.086	0.094	2.19	2.38	-
A ₁	0.018	0.022	0.46	0.55	4, 5
b	0.028	0.032	0.72	0.81	4, 5
b ₁	0.033	0.040	0.84	1.01	4
b ₂	0.205	0.215	5.21	5.46	4, 5
b ₃	0.190	-	4.83	-	2
c	0.018	0.022	0.46	0.55	4, 5
D	0.270	0.290	6.86	7.36	-
E	0.250	0.265	6.35	6.73	-
e	0.090 TYP		2.28 TYP		7
e ₁	0.180 BSC		4.57 BSC		7
H ₁	0.035	0.045	0.89	1.14	-
J ₁	0.040	0.045	1.02	1.14	-
L	0.100	0.115	2.54	2.92	-
L ₁	0.020	-	0.51	-	4, 6
L ₂	0.025	0.040	0.64	1.01	3
L ₃	0.170	-	4.32	-	2

NOTES:

1. These dimensions are within allowable dimensions of Rev. B of JEDEC TO-252AA outline dated 9-88.
2. L₃ and b₃ dimensions establish a minimum mounting surface for terminal 4.
3. Solder finish uncontrolled in this area.
4. Dimension (without solder).
5. Add typically 0.002 inches (0.05mm) for solder plating.
6. L₁ is the terminal length for soldering.
7. Position of lead to be measured 0.090 inches (2.28mm) from bottom of dimension D.
8. Controlling dimension: Inch.
9. Revision 6 dated 10-96.

RFD16N02L, RFD16N02LSM

TO-252AA

16mm TAPE AND REEL

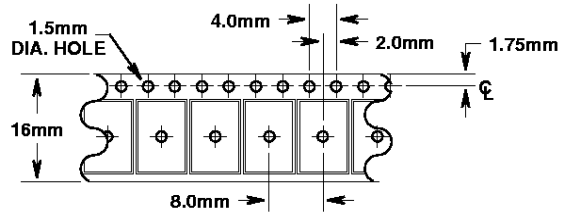
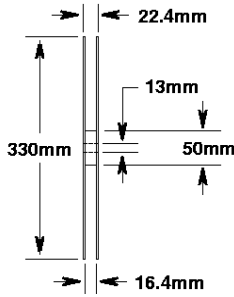
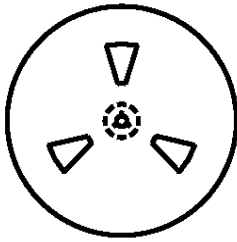

USER DIRECTION OF FEED

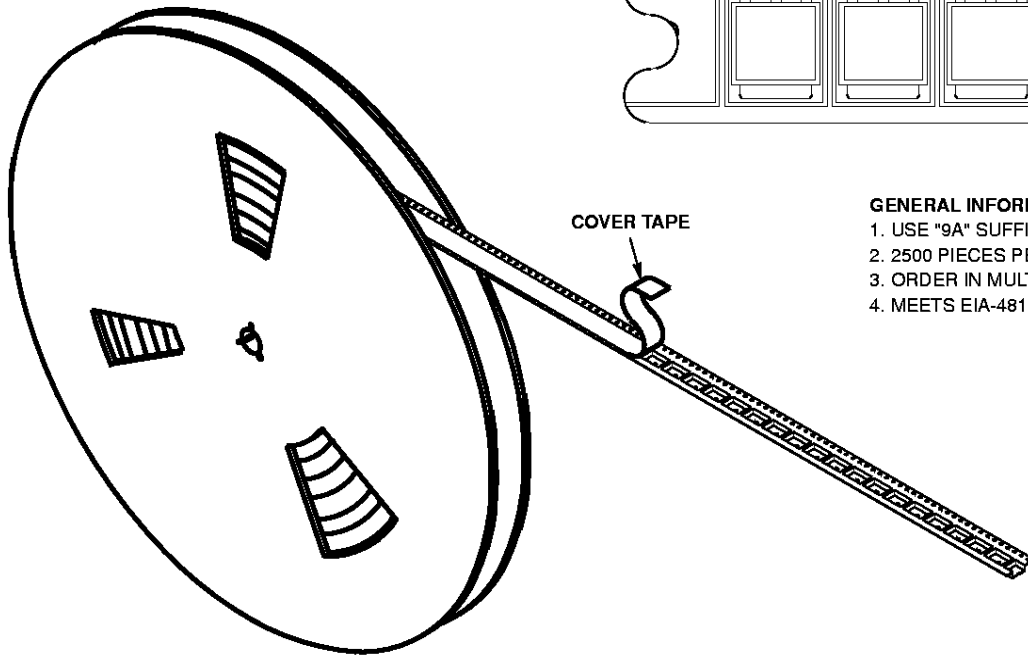
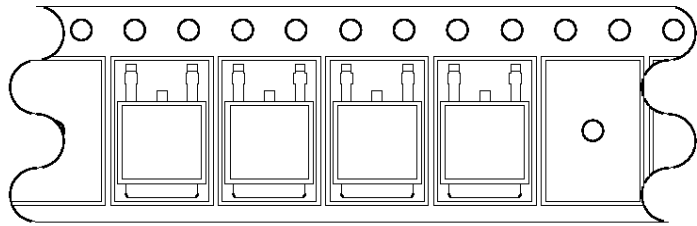

GENERAL INFORMATION

1. USE "9A" SUFFIX ON PART NUMBER.
2. 2500 PIECES PER REEL.
3. ORDER IN MULTIPLES OF FULL REELS ONLY.
4. MEETS EIA-481 REVISION "A" SPECIFICATIONS.

Revision 6 dated 10-96

All Harris Semiconductor products are manufactured, assembled and tested under **ISO9000** quality systems certification.

Harris Semiconductor products are sold by description only. Harris Semiconductor reserves the right to make changes in circuit design and/or specifications at any time without notice. Accordingly, the reader is cautioned to verify that data sheets are current before placing orders. Information furnished by Harris is believed to be accurate and reliable. However, no responsibility is assumed by Harris or its subsidiaries for its use; nor for any infringements of patents or other rights of third parties which may result from its use. No license is granted by implication or otherwise under any patent or patent rights of Harris or its subsidiaries.

Sales Office Headquarters

For general information regarding Harris Semiconductor and its products, call **1-800-4-HARRIS**

NORTH AMERICA

Harris Semiconductor
P. O. Box 883, Mail Stop 53-210
Melbourne, FL 32902
TEL: 1-800-442-7747
(407) 729-4984
FAX: (407) 729-5321

EUROPE

Harris Semiconductor
Mercure Center
100, Rue de la Fusee
1130 Brussels, Belgium
TEL: (32) 2.724.2111
FAX: (32) 2.724.22.05

ASIA

Harris Semiconductor PTE Ltd.
No. 1 Tannery Road
Cencon 1, #09-01
Singapore 1334
TEL: (65) 748-4200
FAX: (65) 748-0400

