

T-43-21



CD4070B, CD4077B Types

CMOS Quad Exclusive-OR and Exclusive-NOR Gates

High-Voltage Types (20-Volt Rating)

CD4070B – Quad Exclusive-OR Gate
CD4077B – Quad Exclusive-NOR Gate

■ CD4070B contains four independent Exclusive-OR gates. The RCA-CD4077B contains four independent Exclusive-NOR gates.

The CD4070B and CD4077B provide the system designer with a means for direct implementation of the Exclusive-OR and Exclusive-NOR functions, respectively.

The CD4070B and CD4077B types are supplied in 14-lead hermetic dual-in-line ceramic packages (D and F suffixes), 14-lead dual-in-line plastic packages (E suffix), and in chip form (H suffix).

MAXIMUM RATINGS, Absolute-Maximum Values:

DC SUPPLY-VOLTAGE RANGE, (V _{DD})	
Voltages referenced to V _{SS} Terminal	-0.5V to +20V
INPUT VOLTAGE RANGE, ALL INPUTS	-0.5V to V _{DD} +0.5V
DC INPUT CURRENT, ANY ONE INPUT	±10mA
POWER DISSIPATION PER PACKAGE (P _D):	
For T _A = -55°C to +100°C	500mW
For T _A = +100°C to +125°C	Derate Linearly at 12mW/°C to 200mW
DEVICE DISSIPATION PER OUTPUT TRANSISTOR	
FOR T _A = FULL PACKAGE-TEMPERATURE RANGE (All Package Types)	100mW
OPERATING-TEMPERATURE RANGE (T _A)	-55°C to +125°C
STORAGE TEMPERATURE RANGE (T _{stg})	-65°C to +150°C
LEAD TEMPERATURE (DURING SOLDERING):	
At distance 1/16 ± 1/32 inch (1.59 ± 0.79mm) from case for 10s max	+265°C

Features:

- Medium-speed operation—t_{PHL}, t_{PLH} = 65 ns (typ.) at V_{DD} = 10 V, C_L = 50 pF
- 100% tested for quiescent current at 20 V
- Standardized symmetrical output characteristics
- 5-V, 10-V, and 15-V parametric ratings
- Maximum input current of 1 μA at 18 V over full package-temperature range; 100 nA at 18 V and 25°C
- Noise margin (over full package-temperature range):
 - 1 V at V_{DD} = 5 V
 - 2 V at V_{DD} = 10 V
 - 2.5 V at V_{DD} = 15 V
- Meets all requirements of JEDEC Tentative Standard No. 13B, "Standard Specifications for Description of 'B' Series CMOS Devices"

Applications:

- Logical comparators
- Adders/subtractors
- Parity generators and checkers

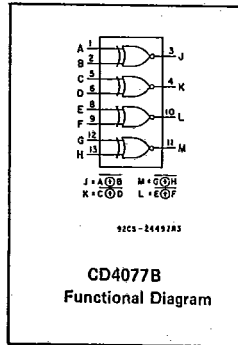
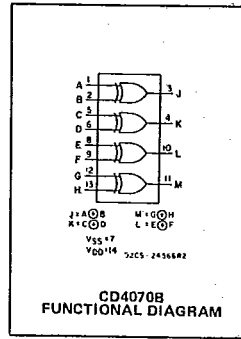

COMMERCIAL CMOS
HIGH VOLTAGE ICs

RECOMMENDED OPERATING CONDITIONS

For maximum reliability, nominal operating conditions should be selected so that operation is always within the following ranges:

Characteristic	Min.	Max.	Units
Supply-Voltage Range (For T _A = Full Package-Temperature Range)	3	18	V

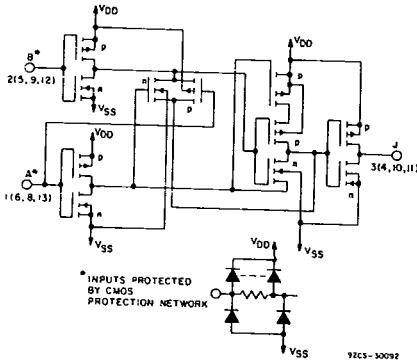

TRUTH TABLE CD4070B
1 of 4 Gates

A	B	J
0	0	0
1	0	1
0	1	1
1	1	0

1 = HIGH LEVEL
0 = LOW LEVEL
J = A ⊕ B

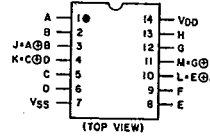

TERMINAL ASSIGNMENT CD4070B

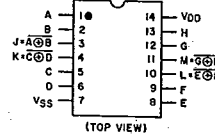

CD4070B, CD4077B Types

T-43-21

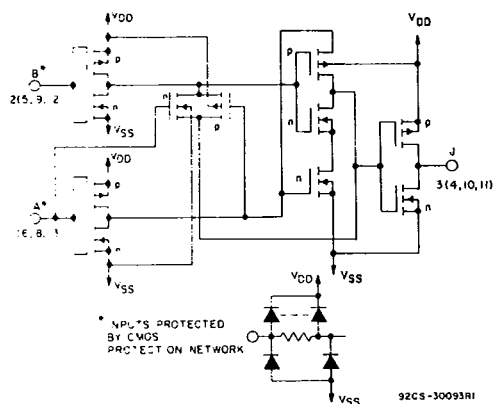

Fig. 2 - Schematic diagram for CD4077B (1 of 4 identical gates).

TRUTH TABLE CD4077B
1 of 4 Gates

A	B	J
0	0	1
1	0	0
0	1	0
1	1	1

1 = HIGH LEVEL
0 = LOW LEVEL
J = A ⊕ B

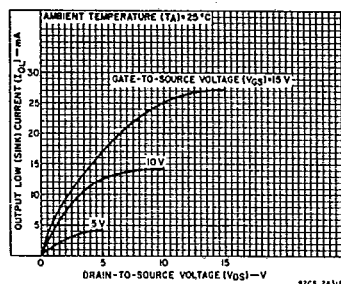

Fig. 3 - Typical output low (sink) current characteristics.

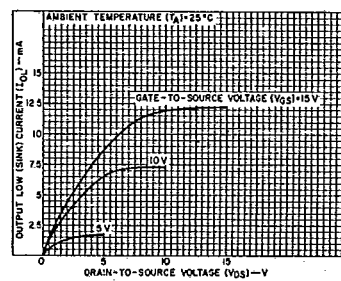

Fig. 4 - Minimum output low (sink) current characteristics.

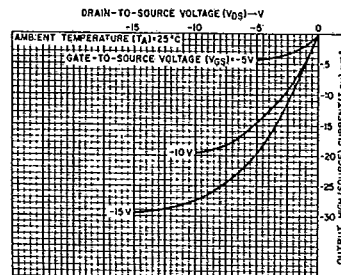

Fig. 5 - Typical output high (source) current characteristics.

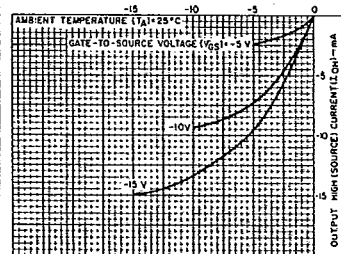

Fig. 6 - Minimum output high (source) current characteristics.

STATIC ELECTRICAL CHARACTERISTICS

CHARACTERISTIC	CONDITIONS			LIMITS AT INDICATED TEMPERATURES (°C)							UNITS
	V _O (V)	V _{IN} (V)	V _{DD} (V)	-55	-40	+85	+125	+25			
								Min.	Typ.	Max.	
Quiescent Device Current	-	0.5	5	0.25	0.25	7.5	7.5	-	0.01	0.25	μA
I _{DD} Max.	-	0.10	10	0.5	0.5	15	15	-	0.01	0.5	
Output Low (Sink) Current, I _{OL} Min.	0.4	0.5	5	0.64	0.61	0.42	0.36	0.51	1	-	mA
I _{OL} Max.	0.5	0.10	10	1.6	1.5	1.1	0.9	1.3	2.6	-	
Output High (Source) Current, I _{OH} Min.	4.6	0.5	5	-0.64	-0.61	-0.42	-0.36	-0.51	-1	-	mA
I _{OH} Max.	2.5	0.5	5	-2	-1.8	-1.3	-1.15	-1.6	-3.2	-	
Output Voltage: Low-Level, V _{OL} Max.	-	0.5	5	0.05				-	0	0.05	V
V _{OL} Max.	-	0.10	10	0.05				-	0	0.05	
Output Voltage: High-Level, V _{OH} Min.	-	0.5	5	4.95				4.95	5	-	V
V _{OH} Min.	-	0.10	10	9.95				9.95	10	-	
Input Low Voltage, V _{IL} Max.	0.5, 4.5	-	5	1.5				-	-	1.5	V
V _{IL} Max.	1.9	-	10	3				-	-	3	
Input High Voltage, V _{IH} Min.	1.5, 13.5	-	15	4				-	-	4	V
V _{IH} Min.	0.5, 4.5	-	5	3.5				3.5	-	-	
I _{IH} Max.	1.9	-	10	7				7	-	-	μA
I _{IH} Max.	1.5, 13.5	-	15	11				11	-	-	
Input Current, I _{IN} Max.	-	0.18	18	±0.1	±0.1	±1	±1	-	±10 ⁻⁵	±0.1	μA

CD4070B, CD4077B Types

T-43-21

DYNAMIC ELECTRICAL CHARACTERISTICS at $T_A = 25^\circ\text{C}$; Input $t_r, t_f = 20 \text{ ns}$, $C_L = 50 \text{ pF}$, $R_L = 200 \text{ K}\Omega$

CHARACTERISTIC	CONDITIONS	ALL TYPES LIMITS		UNITS	
		V_{DD} V	Typ.		Max.
Propagation Delay Time; t_{PHL}, t_{PLH}		5	140	280	ns
		10	65	130	
		15	50	100	
Transition Time; t_{THL}, t_{TLH}		5	100	200	ns
		10	50	100	
		15	40	80	
Input Capacitance; C_{IN}	Any Input	5	7.5	pF	

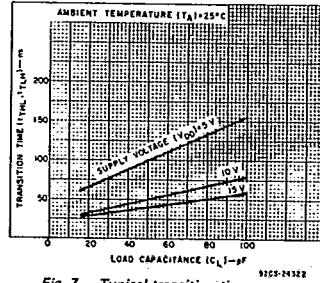

Fig. 7 - Typical transition time as a function of load capacitance.

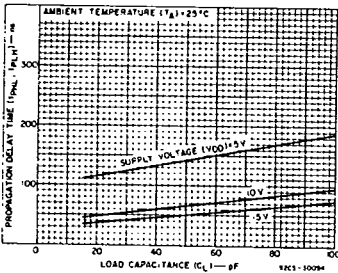

Fig. 8 - Typical propagation delay time as a function of load capacitance.

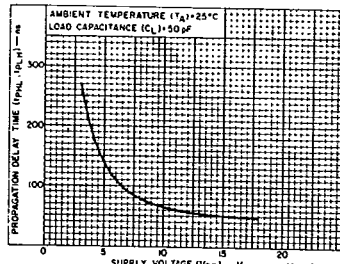

Fig. 9 - Typical propagation delay time as a function of supply voltage.

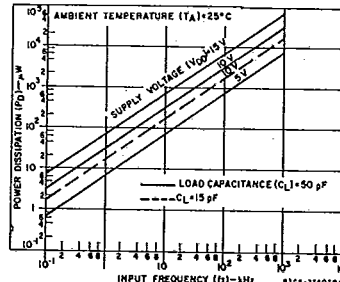
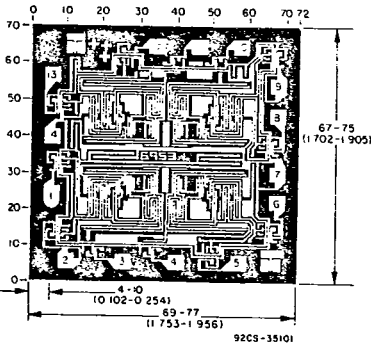

Fig. 10 - Typical dynamic power dissipation as a function of input frequency.



Dimensions and pad layout for CD4077BH. Dimensions and pad layout for CD4070BH are identical.

Dimensions in parentheses are in millimeters and are derived from the basic inch dimensions as indicated. Grid graduations are in mils (10^{-3} inch).

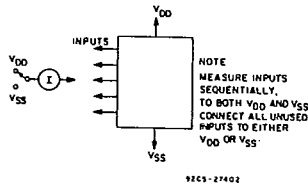

Fig. 11 - Input current test circuit.

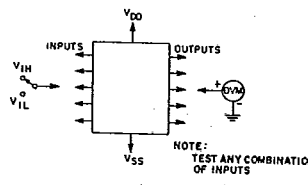

Fig. 12 - Input-voltage test circuit.

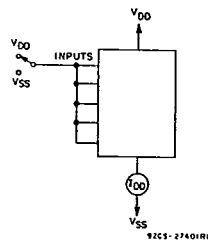

Fig. 13 - Quiescent-device-current test circuit.

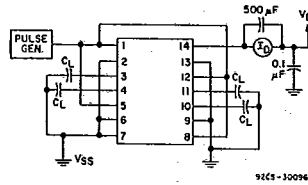

Fig. 14 - Dynamic power dissipation test circuit.

COMMERCIAL CMOS HIGH VOLTAGE ICs