



# FQI7N80

## N-Channel QFET® MOSFET

800 V, 6.6 A, 1.5 Ω

### Description

This N-Channel enhancement mode power MOSFET is produced using Fairchild Semiconductor's proprietary planar stripe and DMOS technology. This advanced MOSFET technology has been especially tailored to reduce on-state resistance, and to provide superior switching performance and high avalanche energy strength. These devices are suitable for switched mode power supplies, active power factor correction (PFC), and electronic lamp ballasts.

### Features

- 6.6 A, 800 V,  $R_{DS(on)} = 1.5 \Omega$  (Max.) @  $V_{GS} = 10 V$ ,  $I_D = 3.7 A$
- Low Gate Charge (Typ. 40 nC)
- Low Crss (Typ. 19 pF)
- 100% Avalanche Tested
- RoHS Compliant

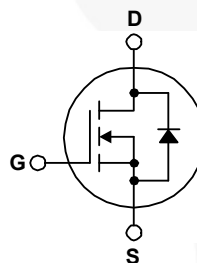
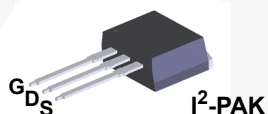

### Absolute Maximum Ratings $T_C = 25^\circ C$ unless otherwise noted.

Symbol	Parameter	FQI7N80TU	Unit
$V_{DSS}$	Drain-Source Voltage	800	V
$I_D$	Drain Current - Continuous ( $T_C = 25^\circ C$ ) - Continuous ( $T_C = 100^\circ C$ )	6.6	A
		4.2	A
$I_{DM}$	Drain Current - Pulsed (Note 1)	26.4	A
$V_{GSS}$	Gate-Source Voltage	$\pm 30$	V
$E_{AS}$	Single Pulsed Avalanche Energy (Note 2)	580	mJ
$I_{AR}$	Avalanche Current (Note 1)	6.6	A
$E_{AR}$	Repetitive Avalanche Energy (Note 1)	16.7	mJ
dv/dt	Peak Diode Recovery dv/dt (Note 3)	4.0	V/ns
$P_D$	Power Dissipation ( $T_A = 25^\circ C$ ) *	3.13	W
	Power Dissipation ( $T_C = 25^\circ C$ )	167	W
	- Derate above $25^\circ C$	1.34	W/ $^\circ C$
$T_J, T_{STG}$	Operating and Storage Temperature Range	-55 to +150	$^\circ C$
$T_L$	Maximum Lead Temperature for Soldering, 1/8" from Case for 5 Seconds.	300	$^\circ C$

### Thermal Characteristics

Symbol	Parameter	FQI7N80TU	Unit
$R_{\theta JC}$	Thermal Resistance, Junction to Case, Max.	0.75	$^\circ C/W$
$R_{\theta JA}$	Thermal Resistance, Junction to Ambient (Minimum Pad of 2-oz Copper), Max.	62.5	
	Thermal Resistance, Junction to Ambient (*1 in <sup>2</sup> Pad of 2-oz Copper), Max.	40	

## Package Marking and Ordering Information

Part Number	Top Mark	Package	Packing Method	Reel Size	Tape Width	Quantity
FQI7N80TU	FQI7N80	I <sup>2</sup> -PAK	Tube	N/A	N/A	50 units

## Electrical Characteristics

$T_C = 25^\circ\text{C}$  unless otherwise noted.

Symbol	Parameter	Test Conditions	Min.	Typ.	Max.	Unit
--------	-----------	-----------------	------	------	------	------

### Off Characteristics

$BV_{DSS}$	Drain-Source Breakdown Voltage	$V_{GS} = 0\text{ V}, I_D = 250\mu\text{ A}$	800	--	--	V
$\Delta BV_{DSS} / \Delta T$	Breakdown Voltage Temperature Coefficient	$I_D = 250\mu\text{ A}$ , Referenced to $25^\circ\text{C}$	--	0.77	--	V/ $^\circ\text{C}$
$I_{DSS}$	Zero Gate Voltage Drain Current	$V_{DS} = 800\text{ V}, V_{GS} = 0\text{ V}$	--	--	10	$\mu\text{A}$
		$V_{DS} = 640\text{ V}, T_C = 125^\circ\text{C}$	--	--	100	$\mu\text{A}$
$I_{GSSF}$	Gate-Body Leakage Current, Forward	$V_{GS} = 30\text{ V}, V_{DS} = 0\text{ V}$	--	--	100	nA
$I_{GSSR}$	Gate-Body Leakage Current, Reverse	$V_{GS} = -30\text{ V}, V_{DS} = 0\text{ V}$	--	--	-100	nA

### On Characteristics

$V_{GS(th)}$	Gate Threshold Voltage	$V_{DS} = V_{GS}, I_D = 250\mu\text{ A}$	3.0	--	5.0	V
$R_{DS(on)}$	Static Drain-Source On-Resistance	$V_{GS} = 10\text{ V}, I_D = 3.3\text{ A}$	--	1.2	1.5	$\Omega$
$g_{FS}$	Forward Transconductance	$V_{DS} = 50\text{ V}, I_D = 3.3\text{ A}$	--	5	--	S

### Dynamic Characteristics

$C_{iss}$	Input Capacitance	$V_{DS} = 25\text{ V}, V_{GS} = 0\text{ V},$ $f = 1.0\text{ MHz}$	--	1420	1850	pF
$C_{oss}$	Output Capacitance		--	150	195	pF
$C_{rss}$	Reverse Transfer Capacitance		--	19	25	pF

### Switching Characteristics

$t_{d(on)}$	Turn-On Delay Time	$V_{DD} = 400\text{ V}, I_D = 6.6\text{ A},$ $R_G = 25\Omega$	--	35	80	ns
$t_r$	Turn-On Rise Time		--	80	170	ns
$t_{d(off)}$	Turn-Off Delay Time		--	95	200	ns
$t_f$	Turn-Off Fall Time		--	55	120	ns
$Q_g$	Total Gate Charge	$V_{DS} = 640\text{ V}, I_D = 6.6\text{ A},$ $V_{GS} = 10\text{ V}$	--	40	52	nC
$Q_{gs}$	Gate-Source Charge		--	8.5	--	nC
$Q_{gd}$	Gate-Drain Charge		--	20	--	nC

### Drain-Source Diode Characteristics and Maximum Ratings

$I_S$	Maximum Continuous Drain-Source Diode Forward Current	--	--	6.6	A	
$I_{SM}$	Maximum Pulsed Drain-Source Diode Forward Current	--	--	26.4	A	
$V_{SD}$	Drain-Source Diode Forward Voltage	$V_{GS} = 0\text{ V}, I_S = 6.6\text{ A}$	--	--	1.4	V
$t_{rr}$	Reverse Recovery Time	$V_{GS} = 0\text{ V}, I_S = 6.6\text{ A},$	--	400	--	ns
$Q_{rr}$	Reverse Recovery Charge	$di_F / dt = 100\text{ A}/\mu\text{s}$	--	4.3	--	$\mu\text{C}$

#### Notes:

1. Repetitive rating : pulse-width limited by maximum junction temperature.
2.  $L = 25\text{ mH}, I_{AS} = 6.6\text{ A}, V_{DD} = 50\text{ V}, R_G = 25\Omega$ , starting  $T_J = 25^\circ\text{C}$ .
3.  $I_{SD} \leq 6.6\text{ A}, di/dt \leq 200\text{ A}/\mu\text{s}, V_{DD} \leq BV_{DSS}$ , starting  $T_J = 25^\circ\text{C}$ .
4. Essentially independent of operating temperature.

## Typical Characteristics

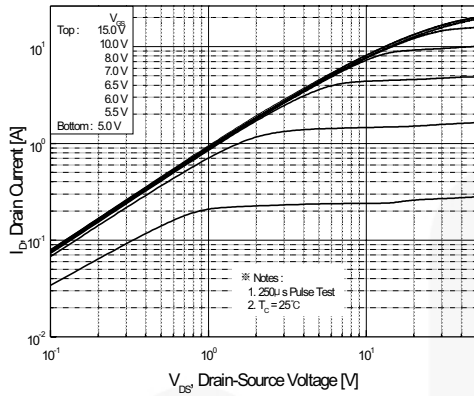

Figure 1. On-Region Characteristics

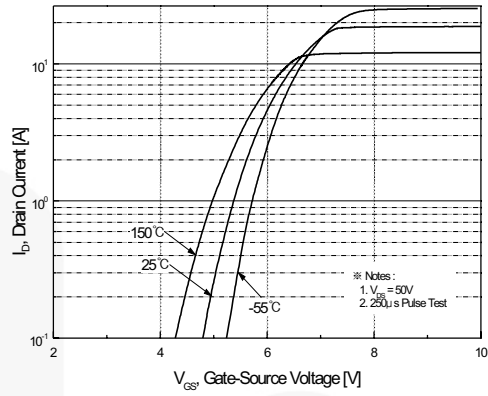

Figure 2. Transfer Characteristics

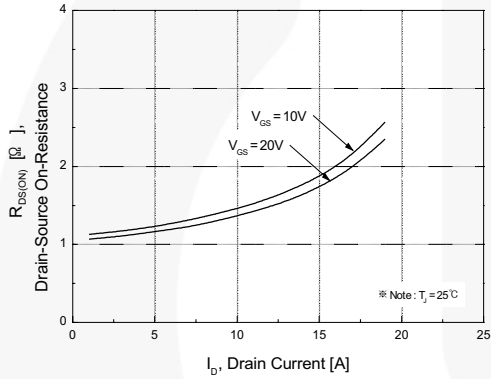

Figure 3. On-Resistance Variation vs. Drain Current and Gate Voltage

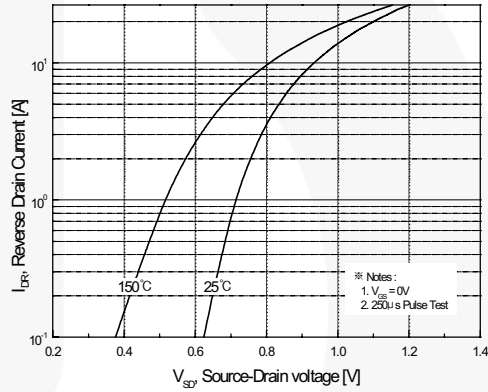

Figure 4. Body Diode Forward Voltage Variation vs. Source Current and Temperature

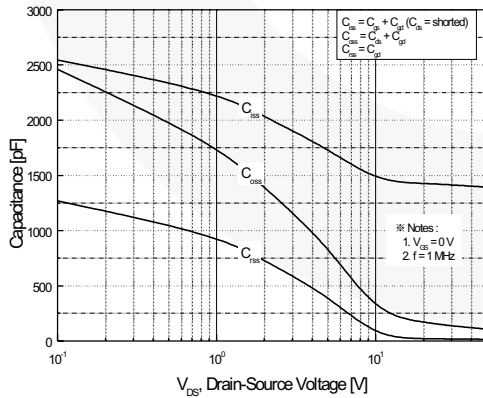

Figure 5. Capacitance Characteristics

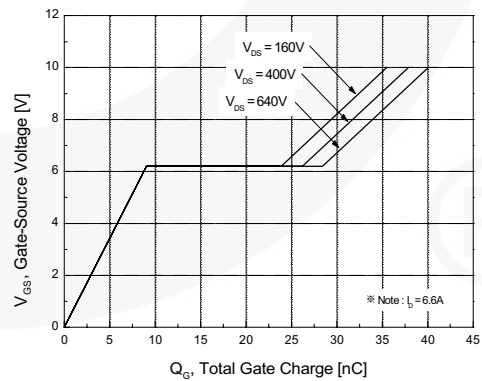
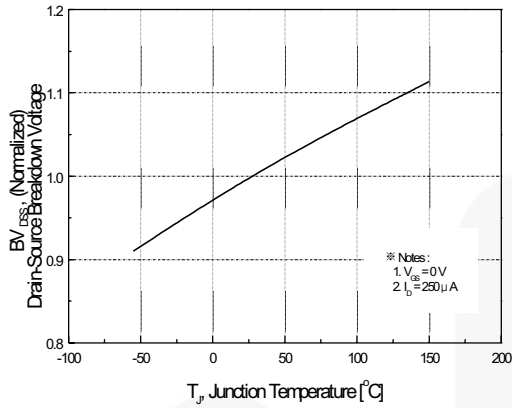
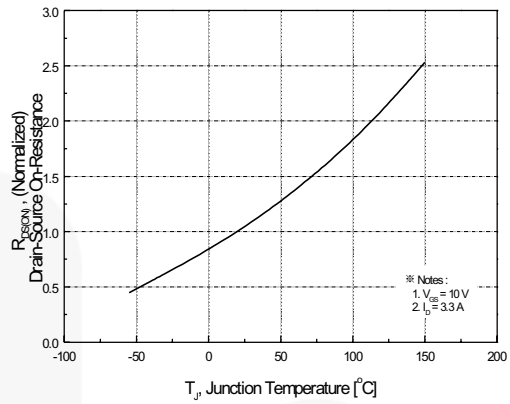

Figure 6. Gate Charge Characteristics

**Typical Characteristics** (Continued)



**Figure 7. Breakdown Voltage Variation vs. Temperature**



**Figure 8. On-Resistance Variation vs. Temperature**

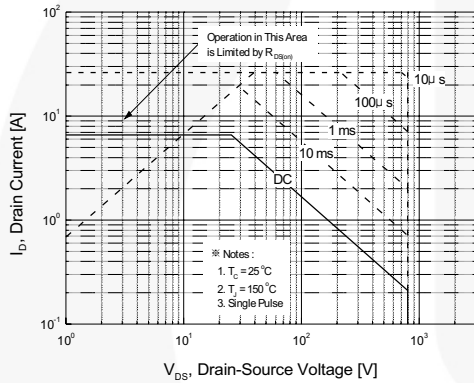

**Figure 9. Maximum Safe Operating Area**

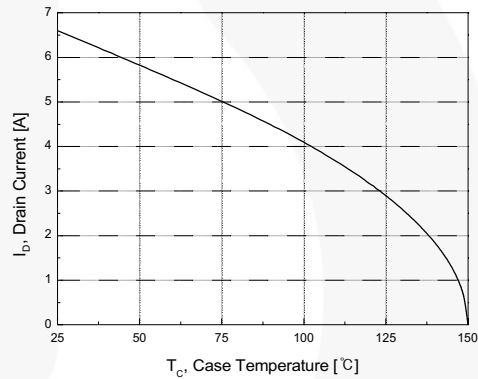

**Figure 10. Maximum Drain Current vs. Case Temperature**

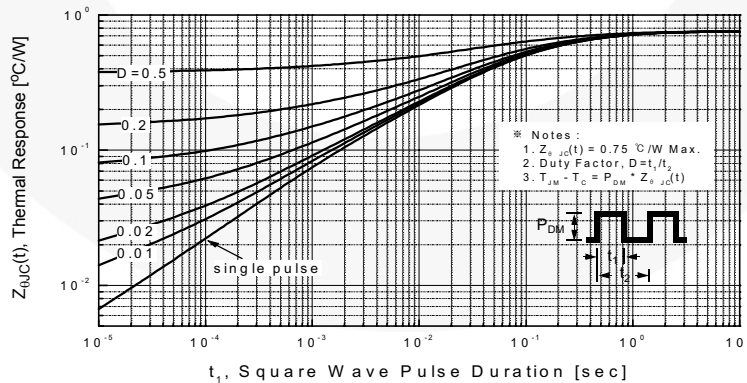

**Figure 11. Transient Thermal Response Curve**



Figure 12. Gate Charge Test Circuit & Waveform

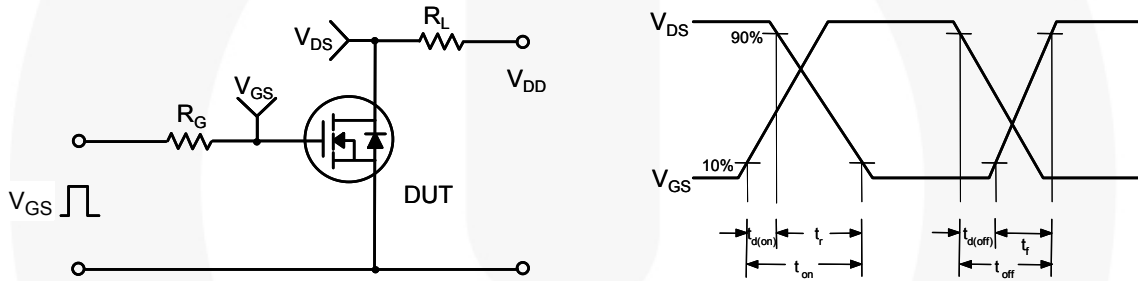

Figure 13. Resistive Switching Test Circuit & Waveforms

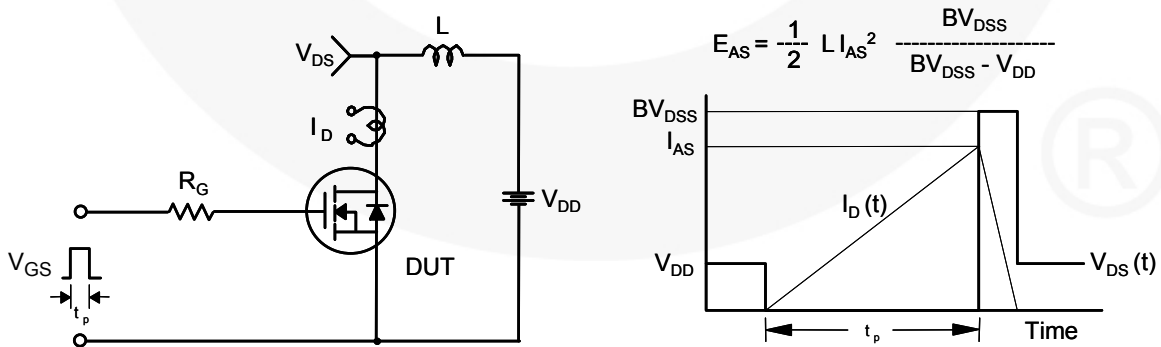
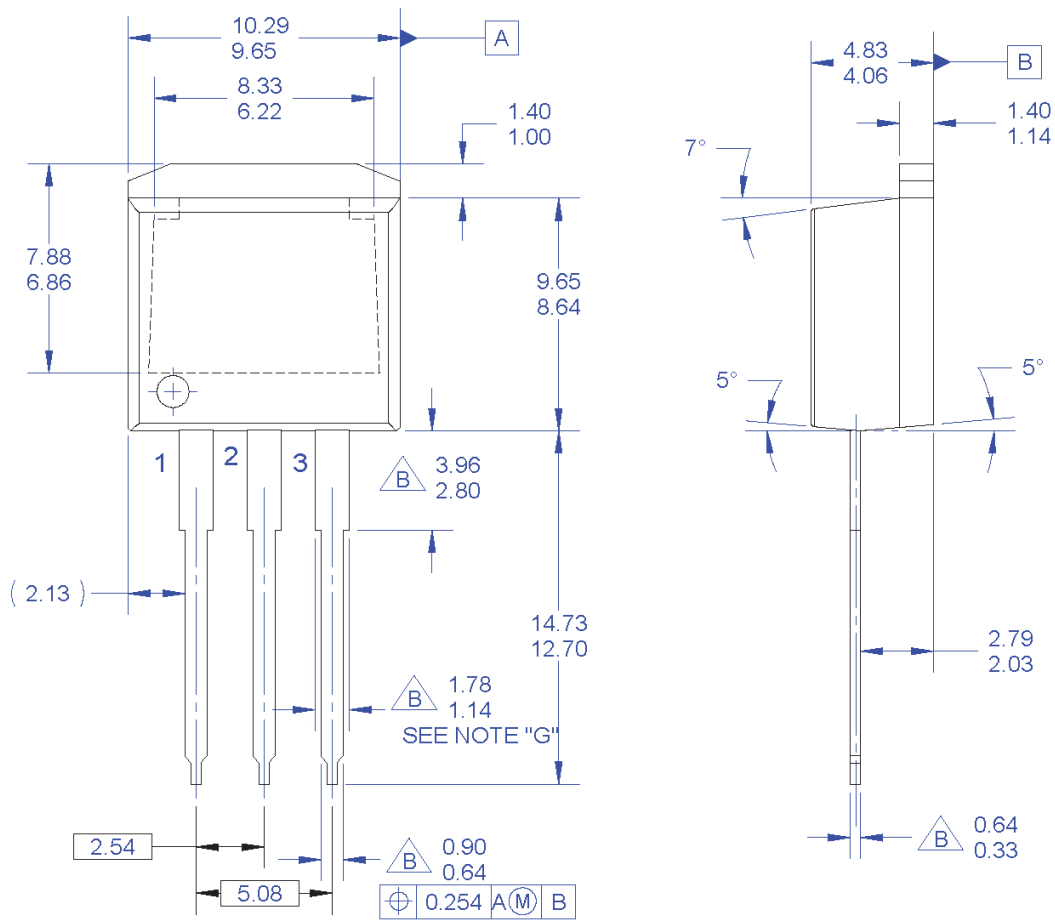

Figure 14. Unclamped Inductive Switching Test Circuit & Waveforms



Figure 15. Peak Diode Recovery  $dv/dt$  Test Circuit & Waveforms

## Mechanical Dimensions



### NOTES:

- A. EXCEPT WHERE NOTED CONFORMS TO TO262 JEDEC VARIATION AA.
- B. DOES NOT COMPLY JEDEC STD. VALUE.
- C. ALL DIMENSIONS ARE IN MILLIMETERS.
- D. DIMENSIONS ARE EXCLUSIVE OF BURRS, MOLD FLASH AND TIE BAR PROTRUSIONS.
- E. DIMENSION AND TOLERANCE AS PER ANSI Y14.5-1994.
- F. LOCATION OF PIN HOLE MAY VARY (LOWER LEFT CORNER, LOWER CENTER AND CENTER OF PACKAGE)
- G. MAXIMUM WIDTH FOR F102 DEVICE = 1.35 MAX.
- H. DRAWING FILE NAME: TO262A03REV5

**Figure 16. TO262 (I<sup>2</sup>PAK), Molded, 3-Lead, Jedec Variation AA**

Package drawings are provided as a service to customers considering Fairchild components. Drawings may change in any manner without notice. Please note the revision and/or date on the drawing and contact a Fairchild Semiconductor representative to verify or obtain the most recent revision. Package specifications do not expand the terms of Fairchild's worldwide terms and conditions, specifically the warranty therein, which covers Fairchild products.

Always visit Fairchild Semiconductor's online packaging area for the most recent package drawings:

[http://www.fairchildsemi.com/package/packageDetails.html?id=PN\\_TT262-003](http://www.fairchildsemi.com/package/packageDetails.html?id=PN_TT262-003)



**TRADEMARKS**

The following includes registered and unregistered trademarks and service marks, owned by Fairchild Semiconductor and/or its global subsidiaries, and is not intended to be an exhaustive list of all such trademarks.

- |                          |   |                            |                  |
|--------------------------|---|----------------------------|------------------|
| AccuPower™               | F-PFS™  | PowerTrench®               | Sync-Lock™       |
| AX-CAP®*                 | FRFET®  | PowerXS™                   | SYSTEM GENERAL®* |
| BitSiC™                  | Global Power ResourceSM                         | Programmable Active Droop™ | TinyBoost®       |
| Build it Now™            | GreenBridge™                                    | QFET®                      | TinyBuck®        |
| CorePLUS™                | Green FPS™                                      | QS™                        | TinyCalc™        |
| CorePOWER™               | Green FPS™ e-Series™                            | Quiet Series™              | TinyLogic®       |
| CROSSVOLT™               | Gmax™   | RapidConfigure™            | TINYOPTO™        |
| CTL™                     | GTO™  |                            | TinyPower™       |
| Current Transfer Logic™  | IntelliMAX™                                     |                            | TinyPWM™         |
| DEUXPEED®                | ISOPLANAR™                                      |                            | TinyWire™        |
| Dual Cool™               | Marking Small Speakers Sound Louder and Better™ |                            | TranSiC™         |
| EcoSPARK®                | MegaBuck™                                       |                            | TriFault Detect™ |
| EfficientMax™            | MICROCOUPLER™                                   |                            | TRUECURRENT®*    |
| ESBC™                    | MicroFET™                                       |                            | µSerDes™         |
| <b>F</b> ®               | MicroPak™                                       |                            | <b>µ</b> SerDes™ |
| Fairchild®               | MicroPak2™                                      |                            | UHC®             |
| Fairchild Semiconductor® | MillerDrive™                                    |                            | Ultra FRFET™     |
| FACT Quiet Series™       | MotionMax™                                      |                            | UniFET™          |
| FACT®                    | mWSaver®  |                            | VCX™             |
| FAST®                    | OptoHiT™  |                            | VisualMax™       |
| FastvCore™               | OPTOLOGIC®                                      |                            | VoltagePlus™     |
| FETBench™                | OPTOPLANAR®                                     |                            | XS™              |
| FPS™                     |   |                            |                  |

\*Trademarks of System General Corporation, used under license by Fairchild Semiconductor.

**DISCLAIMER**

FAIRCHILD SEMICONDUCTOR RESERVES THE RIGHT TO MAKE CHANGES WITHOUT FURTHER NOTICE TO ANY PRODUCTS HEREIN TO IMPROVE RELIABILITY, FUNCTION, OR DESIGN. FAIRCHILD DOES NOT ASSUME ANY LIABILITY ARISING OUT OF THE APPLICATION OR USE OF ANY PRODUCT OR CIRCUIT DESCRIBED HEREIN; NEITHER DOES IT CONVEY ANY LICENSE UNDER ITS PATENT RIGHTS, NOR THE RIGHTS OF OTHERS. THESE SPECIFICATIONS DO NOT EXPAND THE TERMS OF FAIRCHILD'S WORLDWIDE TERMS AND CONDITIONS, SPECIFICALLY THE WARRANTY THEREIN, WHICH COVERS THESE PRODUCTS.

**LIFE SUPPORT POLICY**

FAIRCHILD'S PRODUCTS ARE NOT AUTHORIZED FOR USE AS CRITICAL COMPONENTS IN LIFE SUPPORT DEVICES OR SYSTEMS WITHOUT THE EXPRESS WRITTEN APPROVAL OF FAIRCHILD SEMICONDUCTOR CORPORATION.

As used here in:

- Life support devices or systems are devices or systems which, (a) are intended for surgical implant into the body or (b) support or sustain life, and (c) whose failure to perform when properly used in accordance with instructions for use provided in the labeling, can be reasonably expected to result in a significant injury of the user.
- A critical component in any component of a life support, device, or system whose failure to perform can be reasonably expected to cause the failure of the life support device or system, or to affect its safety or effectiveness.

**ANTI-COUNTERFEITING POLICY**

Fairchild Semiconductor Corporation's Anti-Counterfeiting Policy. Fairchild's Anti-Counterfeiting Policy is also stated on our external website, [www.Fairchildsemi.com](http://www.Fairchildsemi.com), under Sales Support. Counterfeiting of semiconductor parts is a growing problem in the industry. All manufactures of semiconductor products are experiencing counterfeiting of their parts. Customers who inadvertently purchase counterfeit parts experience many problems such as loss of brand reputation, substandard performance, failed application, and increased cost of production and manufacturing delays. Fairchild is taking strong measures to protect ourselves and our customers from the proliferation of counterfeit parts. Fairchild strongly encourages customers to purchase Fairchild parts either directly from Fairchild or from Authorized Fairchild Distributors who are listed by country on our web page cited above. Products customers buy either from Fairchild directly or from Authorized Fairchild Distributors are genuine parts, have full traceability, meet Fairchild's quality standards for handling and storage and provide access to Fairchild's full range of up-to-date technical and product information. Fairchild and our Authorized Distributors will stand behind all warranties and will appropriately address and warranty issues that may arise. Fairchild will not provide any warranty coverage or other assistance for parts bought from Unauthorized Sources. Fairchild is committed to combat this global problem and encourage our customers to do their part in stopping this practice by buying direct or from authorized distributors.

**PRODUCT STATUS DEFINITIONS**

**Definition of Terms**

Datasheet Identification	Product Status	Definition
Advance Information	Formative / In Design	Datasheet contains the design specifications for product development. Specifications may change in any manner without notice.
Preliminary	First Production	Datasheet contains preliminary data; supplementary data will be published at a later date. Fairchild Semiconductor reserves the right to make changes at any time without notice to improve design.
No Identification Needed	Full Production	Datasheet contains final specifications. Fairchild Semiconductor reserves the right to make changes at any time without notice to improve the design.
Obsolete	Not In Production	Datasheet contains specifications on a product that is discontinued by Fairchild Semiconductor. The datasheet is for reference information only.

Rev. I66