

ICL76XX

ICL76XX Series Low Power CMOS Operational Amplifiers

GENERAL DESCRIPTION

The ICL761X/762X/763X/764X series is a family of monolithic CMOS operational amplifiers. These devices provide the designer with high performance operation at low supply voltages and selectable quiescent currents, and are an ideal design tool when ultra low input current and low power dissipation are desired.

The basic amplifier will operate at supply voltages ranging from $\pm 1V$ to $\pm 8V$, and may be operated from a single Lithium cell.

A unique quiescent current programming pin allows setting of standby current to 1mA, 100 μ A, or 10 μ A, with no external components. This results in power consumption as low as 20 μ W. Output swings range to within a few millivolts of the supply voltages.

Of particular significance is the extremely low (1pA) input current, input noise current of .01pA/ \sqrt{Hz} , and $10^{12}\Omega$ input impedance. These features optimize performance in very high source impedance applications.

The inputs are internally protected. Outputs are fully protected against short circuits to ground or to either supply.

AC performance is excellent, with a slew rate of 1.6V/ μ s, and unity gain bandwidth of 1MHz at $I_Q = 1mA$.

Because of the low power dissipation, operating temperatures and drift are quite low. Applications utilizing these features may include stable instruments, extended life designs, or high density packages.

SELECTION GUIDE

DEVICE NOMENCLATURE

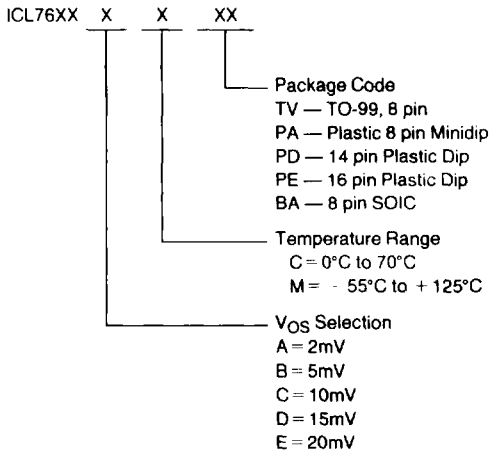

FEATURES

- Wide Operating Voltage Range $\pm 1V$ to $\pm 8V$
- High Input Impedance — $10^{12}\Omega$
- Programmable Power Consumption — Low As 20 μ W
- Input Current Lower Than BIFETs — Typ 1pA
- Available As Singles, Duals, Triples, and Quads
- Output Voltage Swings to Within Millivolts Of V^- and V^+
- Low Power Replacement for Many Standard Op Amps
- Compensated and Uncompensated Versions
- Input Common Mode Voltage Range Greater Than Supply Rails (ICL7612)

APPLICATIONS

- Portable Instruments
- Telephone Headsets
- Hearing Aid/Microphone Amplifiers
- Meter Amplifiers
- Medical Instruments
- High Impedance Buffers

SPECIAL FEATURE CODES

- C = INTERNALLY COMPENSATED
- H = HIGH QUIESCENT CURRENT (1mA)
- L = LOW QUIESCENT CURRENT (10 μ A)
- M = MEDIUM QUIESCENT CURRENT (100 μ A)
- O = OFFSET NULL CAPABILITY
- P = PROGRAMMABLE QUIESCENT CURRENT
- V = EXTENDED CMVR

ICL76XX

ORDERING INFORMATION

Basic Part Number	Number of OP-AMPS in Package, and Special Features (SEE CODES)	Package Type and Suffix				
		8-Lead TO-99		8-Pin MINIDIP	8-Pin SOIC	Plastic DIP (1)
		0°C to +70°C	-55°C to +125°C	0°C to +70°C	0°C to +70°C	0°C to +70°C
ICL7611 ICL7612	SINGLE OP-AMP: C, O, P C, O, P, V	ACTV BCTV DCTV	AMTV BMTV DMTV	ACPA BCPA DCPA	DCBA-T DCBA	
ICL7621	DUAL OP-AMP: C, M	ACTV BCTV DCTV	AMTV BMTV DMTV	ACPA BCPA DCPA	DCBA DCBA-T	
ICL7631	TRIPLE OP-AMP: C, P					CCPE ECPE
ICL7641 ICL7642	QUAD OP-AMP: C, H C, L					CCPD ECPD

NOTES: 1. Duals and quads are available in 14 pin DIP package, triples in 16 pin only.
2. Ordering code must consist of basic part number and package suffix, e.g. ICL7611BCPA.

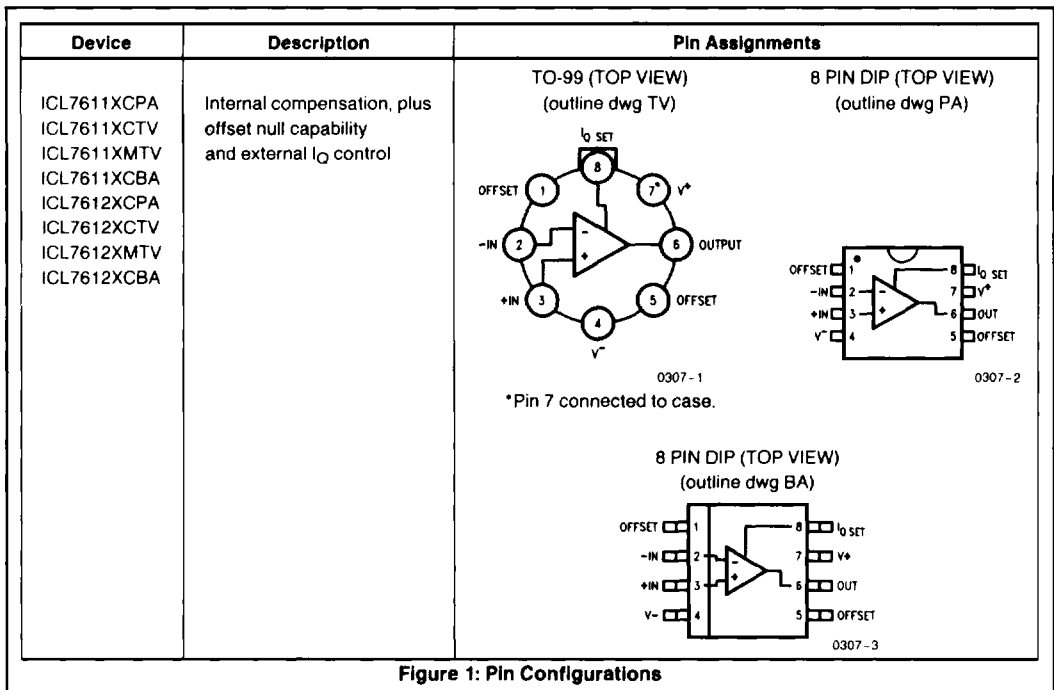

Figure 1: Pin Configurations

NOTE: All typical values have been characterized but are not tested

Device	Description	Pin Assignments
ICL7621XCPA ICL7621XCTV ICL7621XMTV ICL7621XCBA	Dual op amps with internal compensation; I_Q fixed at $100\mu A$ Pin compatible with Texas Inst. TL082 Motorola MC1458 Raytheon RC4558	<p>TO-99 (TOP VIEW) (outline dwg TV)</p>  <p>* PIN DIP (TOP VIEW) (outline dwg PA)</p>  <p>0307-6 0307-7</p> <p>*Pin 8 connected to case.</p>
ICL7631XCPE	Triple op amps with internal compensation. Adjustable I_Q Same pin configuration as ICL8023.	<p>16 PIN DIP (TOP VIEW) (outline dwg PE)</p>  <p>0307-9</p> <p>Note: pins 5 and 15 are internally connected.</p>
ICL7641XCPD ICL7642XCPD	Quad op amps with internal compensation. I_Q fixed at 1mA (ICL7641) I_Q fixed at $10\mu A$ (ICL7642) Pin compatible with Texas Instr. TL084 National LM324 Harris HA4741	<p>14 PIN DIP (TOP VIEW) (outline dwg PD)</p>  <p>0307-10</p>

Figure 1: Pin Configurations (Cont.)

NOTE: All typical values have been characterized but are not tested

ICL76XX

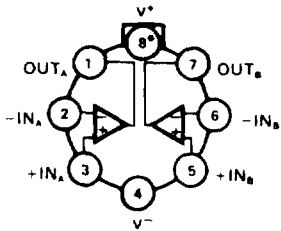
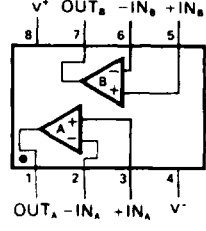
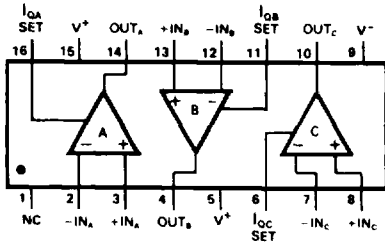
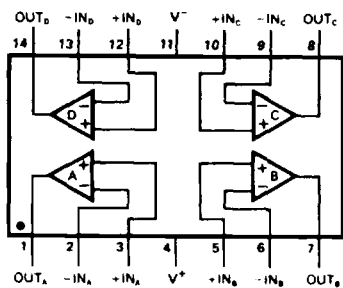
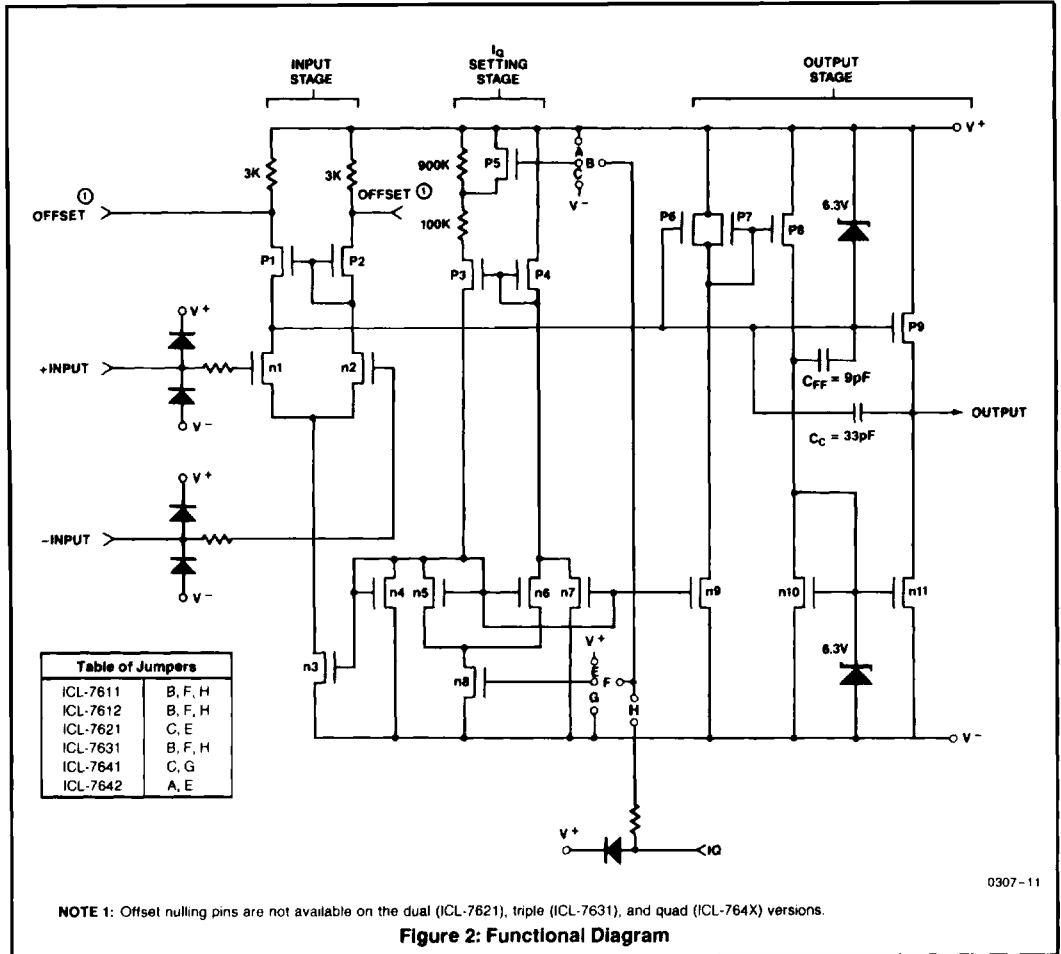

NOTE: All typical values have been characterized but are not tested

ICL76XX

ABSOLUTE MAXIMUM RATINGS

Total Supply Voltage V^+ to V^-	18V
Input Voltage	$V^- - 0.3$ to $V^+ + 0.3$ V
Differential Input Voltage ^[1]	$\pm [(V^+ + 0.3) - (V^- - 0.3)]$ V
Duration of Output Short Circuit ^[2]	Unlimited

Continuous Power Dissipation

	@25°C	Above 25°C
		derate as below:
TO-99	250mW	2mW/°C
8 Lead Minidip	250mW	2mW/°C
14 Lead Plastic	375mW	3mW/°C
14 Lead Cerdip	500mW	4mW/°C
16 Lead Plastic	375mW	3mW/°C
16 Lead Cerdip	500mW	4mW/°C
Storage Temperature Range	-65°C to +150°C	
Operating Temperature Range		
ICL76XXM	-55°C to +125°C	
ICL76XXC	0°C to +70°C	
Lead Temperature (Soldering, 10sec)	300°C	

NOTE: Stresses above those listed under "Absolute Maximum Ratings" may cause permanent damage to the device. These are stress ratings only and functional operation of the device at these or any other conditions above those indicated in the operational sections of the specifications is not implied. Exposure to absolute maximum rating conditions for extended periods may affect device reliability.

- NOTE 1.** Long term offset voltage stability will be degraded if large input differential voltages are applied for long periods of time.
2. The outputs may be shorted to ground or to either supply, for $V_{SUPP} \leq 10$ V. Care must be taken to insure that the dissipation rating is not exceeded.

ELECTRICAL CHARACTERISTICS (7611/12 and 7621 ONLY)

($V_{SUPPLY} = \pm 5.0$ V, $T_A = 25^\circ\text{C}$, unless otherwise specified.)

Symbol	Parameter	Test Conditions	76XXA			76XXB			76XXD			Units
			Min	Typ	Max	Min	Typ	Max	Min	Typ	Max	
V_{OS}	Input Offset Voltage	$R_S \leq 100\text{k}\Omega$, $T_A = 25^\circ\text{C}$ $T_{MIN} \leq T_A \leq T_{MAX}$			2 3			5 7			15 20	mV
$\Delta V_{OS}/\Delta T$	Temperature Coefficient of V_{OS}	$R_S \leq 100\text{k}\Omega$		10			15			25		$\mu\text{V}/^\circ\text{C}$
I_{OS}	Input Offset Current	$T_A = 25^\circ\text{C}$ $\Delta T_A = C_{(2)}$ $\Delta T_A = M_{(2)}$		0.5	30 300 800		0.5	30 300 800		0.5	30 300 800	pA
I_{BIAS}	Input Bias Current	$T_A = 25^\circ\text{C}$ $\Delta T_A = C$ $\Delta T_A = M$		1.0	50 400 4000		1.0	50 400 4000		1.0	50 400 4000	pA
V_{CMR}	Common Mode Voltage Range (Except ICL7612)	$I_Q = 10\mu\text{A}^{(1)}$ $I_Q = 100\mu\text{A}$ $I_Q = 1\text{mA}^{(1)}$	± 4.4 ± 4.2 ± 3.7			± 4.4 ± 4.2 ± 3.7			± 4.4 ± 4.2 ± 3.7			V
V_{CMR}	Extended Common Mode Voltage Range (ICL7612 Only)	$I_Q = 10\mu\text{A}$ $I_Q = 100\mu\text{A}$ $I_Q = 1\text{mA}$	± 5.3 $+5.3$ -5.1 $+5.3$ -4.5			± 5.3 $+5.3$ -5.1 $+5.3$ -4.5			± 5.3 $+5.3$ -5.1 $+5.3$ -4.5			V
V_{OUT}	Output Voltage Swing	(1) $I_Q = 10\mu\text{A}$, $R_L = 1\text{M}\Omega$ $T_A = 25^\circ\text{C}$ $\Delta T_A = C$ $\Delta T_A = M$ $I_Q = 100\mu\text{A}$, $R_L = 100\text{k}\Omega$ $T_A = 25^\circ\text{C}$ $\Delta T_A = C$ $\Delta T_A = M$ (1) $I_Q = 1\text{mA}$, $R_L = 10\text{k}\Omega$ $T_A = 25^\circ\text{C}$ $\Delta T_A = C$ $\Delta T_A = M$	± 4.9 ± 4.8 ± 4.7 ± 4.9 ± 4.8 ± 4.5 ± 4.5 ± 4.3 ± 4.0			± 4.9 ± 4.8 ± 4.7 ± 4.9 ± 4.8 ± 4.5 ± 4.5 ± 4.3 ± 4.0			± 4.9 ± 4.8 ± 4.7 ± 4.9 ± 4.8 ± 4.5 ± 4.5 ± 4.3 ± 4.0			V

NOTE: All typical values have been characterized but are not tested.

ICL76XX

ELECTRICAL CHARACTERISTICS (7611/12 and 7621 ONLY) (Continued)

($V_{SUPPLY} = \pm 5.0V$, $T_A = 25^\circ C$, unless otherwise specified.)

Symbol	Parameter	Test Conditions	76XXA			76XXB			76XXD			Units
			Min	Typ	Max	Min	Typ	Max	Min	Typ	Max	
A _{VOL}	Large Signal Voltage Gain	$V_O = \pm 4.0V$, $R_L = 1M\Omega$ $I_Q = 10\mu A^{(1)}$, $T_A = 25^\circ C$ $\Delta T_A = C$ $\Delta T_A = M$	86	104		80	104		80	104		dB
			80		75		75		75			
			74		68		68		68			
		$V_O = \pm 4.0V$, $R_L = 100k\Omega$ $I_Q = 100\mu A$, $T_A = 25^\circ C$ $\Delta T_A = C$ $\Delta T_A = M$	86	102		80	102		80	102		dB
			80		75		75		75			
			74		68		68		68			
		$V_O = \pm 4.0V$, $R_L = 10k\Omega$ $I_Q = 1mA^{(1)}$, $T_A = 25^\circ C$ $\Delta T_A = C$ $\Delta T_A = M$	80	83		76	83		76	83		dB
			76		72		72		72			
			72		68		68		68			
GBW	Unity Gain Bandwidth	$I_Q = 10\mu A^{(1)}$ $I_Q = 100\mu A$ $I_Q = 1mA^{(1)}$		0.044 0.48 1.4			0.044 0.48 1.4			0.044 0.48 1.4	MHz	
R _{IN}	Input Resistance			10 ¹²			10 ¹²			10 ¹²	Ω	
CMRR	Common Mode Rejection Ratio	$R_S = 100k\Omega$, $I_Q = 10\mu A^{(1)}$	76	96		70	96		70	96		dB
		$R_S = 100k\Omega$, $I_Q = 100\mu A$	76	91		70	91		70	91		
		$R_S = 100k\Omega$, $I_Q = 1mA^{(1)}$	66	87		60	87		60	87		
PSRR	Power Supply Rejection Ratio $V_{SUPPLY} = \pm 8V$ to $\pm 2V$	$R_S = 100k\Omega$, $I_Q = 10\mu A^{(1)}$	80	94		80	94		80	94		dB
		$R_S = 100k\Omega$, $I_Q = 100\mu A$	80	86		80	86		80	86		
		$R_S = 100k\Omega$, $I_Q = 1mA^{(1)}$	70	77		70	77		70	77		
e _n	Input Referred Noise Voltage	$R_S = 100\Omega$, $f = 1kHz$		100			100			100	nV/ \sqrt{Hz}	
i _n	Input Referred Noise Current	$R_S = 100\Omega$, $f = 1kHz$		0.01			0.01			0.01	pA/ \sqrt{Hz}	
I _{SUPPLY}	Supply Current (Per Amplifier)	No Signal, No Load										
		I_Q SET = +5V ⁽¹⁾ Low Bias		0.01	0.02		0.01	0.02		0.01	0.02	mA
		I_Q SET = 0V Medium Bias		0.1	0.25		0.1	0.25		0.1	0.25	
I_Q SET = -5V ⁽¹⁾ High Bias		1.0	2.5		1.0	2.5		1.0	2.5			
V _{O1} /V _{O2}	Channel Separation	$A_V = 100$		120			120			120	dB	
SR	Slew Rate ⁽³⁾	$A_V = 1$, $C_L = 100pF$ $V_{IN} = 8Vp-p$ $I_Q = 10\mu A^{(1)}$, $R_L = 1M\Omega$		0.016			0.016			0.016	V/ μs	
		$I_Q = 100\mu A$, $R_L = 100k\Omega$		0.16			0.16			0.16		
		$I_Q = 1mA^{(1)}$, $R_L = 10k\Omega$		1.6			1.6			1.6		
t _r	Rise Time ⁽³⁾	$V_{IN} = 50mV$, $C_L = 100pF$ $I_Q = 10\mu A^{(1)}$, $R_L = 1M\Omega$		20			20			20	μs	
		$I_Q = 100\mu A$, $R_L = 100k\Omega$		2			2			2		
		$I_Q = 1mA^{(1)}$, $R_L = 10k\Omega$		0.9			0.9			0.9		
	Overshoot Factor ⁽³⁾	$V_{IN} = 50mV$, $C_L = 100pF$ $I_Q = 10\mu A^{(1)}$, $R_L = 1M\Omega$		5			5			5	%	
		$I_Q = 100\mu A$, $R_L = 100k\Omega$		10			10			10		
		$I_Q = 1mA^{(1)}$, $R_L = 10k\Omega$		40			40			40		

NOTES: 1. ICL7611, 7612 only.

2. C Commercial Temperature Range: 0°C to +70°C

M Military Temperature Range: 55°C to +125°C

NOTE: All typical values have been characterized but are not tested.

ICL76XX

ELECTRICAL CHARACTERISTICS (7611/12 A AND B GRADES ONLY)

($V_{SUPPLY} = \pm 1.0V$, $I_O = 10\mu A$, $T_A = 25^\circ C$, unless otherwise specified.)

Symbol	Parameter	Test Conditions	76XXA			76XXB			Units
			Min	Typ	Max	Min	Typ	Max	
V_{OS}	Input Offset Voltage	$R_S \leq 100k\Omega$, $T_A = 25^\circ C$ $T_{MIN} \leq T_A \leq T_{MAX}$			2 3			5 7	mV
$\Delta V_{OS}/\Delta T$	Temperature Coefficient of V_{OS}	$R_S \leq 100k\Omega$		10			15		$\mu V/^\circ C$
I_{OS}	Input Offset Current	$T_A = 25^\circ C$ $\Delta T_A = C$		0.5	30 300		0.5	30 300	pA
I_{BIAS}	Input Bias Current	$T_A = 25^\circ C$ $\Delta T_A = C$		1.0	50 500		1.0	50 500	pA
V_{CMR}	Common Mode Voltage Range (Except ICL7612)		± 0.6			± 0.6			V
V_{CMR}	Extended Common Mode Voltage Range (ICL7612 Only)		+0.6 to -1.1			+0.6 to -1.1			V
V_{OUT}	Output Voltage Swing	$R_L = 1M\Omega$, $T_A = 25^\circ C$ $\Delta T_A = C$		± 0.98 ± 0.96			± 0.98 ± 0.96		V
A_{VOL}	Large Signal Voltage Gain	$V_O = \pm 0.1V$, $R_L = 1M\Omega$ $T_A = 25^\circ C$ $\Delta T_A = C$		90 80			90 80		dB
GBW	Unity Gain Bandwidth			0.044					MHz
R_{IN}	Input Resistance			10 ¹²			10 ¹²		
CMRR	Common Mode Rejection Ratio	$R_S \leq 100k\Omega$		80			80		
PSRR	Power Supply Rejection Ratio	$R_S \leq 100k\Omega$		80			80		dB
e_n	Input Referred Noise Voltage	$R_S = 100\Omega$, $f = 1kHz$		100			100		nV/\sqrt{Hz}
i_n	Input Referred Noise Current	$R_S = 100\Omega$, $f = 1kHz$		0.01			0.01		pA/\sqrt{Hz}
I_{SUPPLY}	Supply Current (Per Amplifier)	No Signal, No Load		6	15		6	15	μA
SR	Slew Rate	$A_V = 1$, $C_L = 100pF$ $V_{IN} = 0.2V_{pp}$ $R_L = 1M\Omega$		0.016			0.016		$V/\mu s$
t_r	Rise Time	$V_{IN} = 50mV$, $C_L = 100pF$ $R_L = 1M\Omega$		20			20		μs
	Overshoot Factor	$V_{IN} = 50mV$, $C_L = 100pF$ $R_L = 1M\Omega$		5			5		%

NOTE: C : Commercial Temperature Range (0°C to +70°C) M : Military Temperature Range (-55°C to +125°C).

NOTE: All typical values have been characterized but are not tested.

ICL76XX

ELECTRICAL CHARACTERISTICS (7631, 7641/42 ONLY)

($V_{SUPPLY} = +5.0V$, $T_A = 25^\circ C$, unless otherwise specified.)

Symbol	Parameter	Test Conditions	76XXC (6)			76XXE (6)			Units
			Min	Typ	Max	Min	Typ	Max	
V_{OS}	Input Offset Voltage	$R_S = 100k\Omega$, $T_A = 25^\circ C$ $T_{MIN} \leq T_A \leq T_{MAX}$			10 15			20 25	mV
$\Delta V_{OS}/\Delta T$	Temperature Coefficient of V_{OS}	$R_S = 100k\Omega$ (Note 5)		20			30		
I_{OS}	Input Offset Current	$T_A = 25^\circ C$ $\Delta T_A = C$ $\Delta T_A = M$		0.5	30 300 800		0.5	30 300 800	pA
I_{BIAS}	Input Bias Current	$T_A = 25^\circ C$ $\Delta T_A = C$ $\Delta T_A = M$		1.0	50 500 4000		1.0	50 500 4000	pA
V_{CMR}	Common Mode Voltage Range	$I_Q = 10\mu A^{(1)}$ $I_Q = 100\mu A^{(3)}$ $I_Q = 1mA^{(2)}$	± 4.4 ± 4.2 ± 3.7			± 4.4 ± 4.2 ± 3.7			V
V_{OUT}	Output Voltage Swing	$I_Q = 10\mu A^{(1)}$, $R_L = 1M\Omega$ $T_A = 25^\circ C$ $\Delta T_A = C$ $\Delta T_A = M$	± 4.9 ± 4.8 ± 4.7			± 4.9 ± 4.8 ± 4.7			V
		$I_Q = 100\mu A^{(3)}$, $R_L = 100k\Omega$ $T_A = 25^\circ C$ $\Delta T_A = C$ $\Delta T_A = M$	± 4.9 ± 4.8 ± 4.5			± 4.9 ± 4.8 ± 4.5			
		$I_Q = 1mA^{(2)}$, $R_L = 10k\Omega$ $T_A = 25^\circ C$ $\Delta T_A = C$ $\Delta T_A = M$	± 4.5 ± 4.3 ± 4.0			± 4.5 ± 4.3 ± 4.0			
A_{VOL}	Large Signal Voltage Gain	$V_O = \pm 4.0V$, $R_L = 1M\Omega^{(1)}$ $I_Q = 10\mu A^{(1)}$, $T_A = 25^\circ C$ $\Delta T_A = C$ $\Delta T_A = M$	80 75 68	104		80 75 68	104		dB
		$V_O = \pm 4.0V$, $R_L = 100k\Omega^{(3)}$ $I_Q = 100\mu A^{(3)}$, $T_A = 25^\circ C$ $\Delta T_A = C$ $\Delta T_A = M$	80 75 68	102		80 75 68	102		
		$V_O = \pm 4.0V$, $R_L = 10k\Omega^{(2)}$ $I_Q = 1mA^{(2)}$, $T_A = 25^\circ C$ $\Delta T_A = C$ $\Delta T_A = M$	76 72 68	98		76 72 68	98		
GBW	Unity Gain Bandwidth	$I_Q = 10\mu A^{(1)}$ $I_Q = 100\mu A^{(3)}$ $I_Q = 1mA^{(2)}$		0.044 0.48 1.4			0.044 0.48 1.4		MHz
R_{IN}	Input Resistance			10^{12}			10^{12}		Ω
$CMRR$	Common Mode Rejection Ratio	$R_S = 100k\Omega$, $I_Q = 10\mu A^{(1)}$	70	96		70	96		dB
		$R_S = 100k\Omega$, $I_Q = 100\mu A$	70	91		70	91		
		$R_S = 100k\Omega$, $I_Q = 1mA^{(2)}$	60	87		60	87		

NOTE: All typical values have been characterized but are not tested

ICL76XX

ELECTRICAL CHARACTERISTICS (7631, 7641/42 ONLY) (Continued)

($V_{SUPPLY} = \pm 5.0V$, $T_A = 25^\circ C$, unless otherwise specified.)

Symbol	Parameter	Test Conditions	76XXC (6)			76XXE (6)			Units
			Min	Typ	Max	Min	Typ	Max	
PSRR	Power Supply Rejection Ratio $V_{SUPPLY} = \pm 8V$ to $\pm 2V$	$R_S \leq 100k\Omega$, $I_Q = 10\mu A^{(1)}$	80	94		80	94		dB
		$R_S \leq 100k\Omega$, $I_Q = 100\mu A$	80	86		80	86		
		$R_S \leq 100k\Omega$, $I_Q = 1mA^{(2)}$	70	77		70	77		
e_n	Input Referred Noise Voltage	$R_S = 100\Omega$, $f = 1kHz$		100			100		nV/\sqrt{Hz}
I_n	Input Referred Noise Current	$R_S = 100\Omega$, $f = 1kHz$		0.01			0.01		pA/\sqrt{Hz}
I_{SUPPLY}	Supply Current (Per Amplifier)	No Signal, No Load 7642 ONLY		0.01	0.03		0.01	0.03	mA
		$I_Q = 10\mu A^{(1)}$ Low Bias		0.01	0.022		0.01	0.022	
		$I_Q = 100\mu A$ Medium Bias		0.1	0.25		0.1	0.25	
		$I_Q = 1mA^{(2)}$ High Bias		1.0	2.5		1.0	2.5	
V_{O1}/V_{O2}	Channel Separation	$A_V = 100$		120			120		dB
SR	Slew Rate	$A_V = 1$, $C_L = 100pF$ $V_{IN} = 8Vp-p$							$V/\mu s$
		$I_Q = 10\mu A^{(1)}$, $R_L = 1M\Omega$		0.016			0.016		
		$I_Q = 100\mu A$, $R_L = 100k\Omega$		0.16			0.16		
		$I_Q = 1mA^{(2)}$, $R_L = 10k\Omega$		1.6			1.6		
t_r	Rise Time	$V_{IN} = 50mV$, $C_L = 100pF$ $I_Q = 10\mu A^{(1)}$, $R_L = 1M\Omega$		20			20		μs
		$I_Q = 100\mu A$, $R_L = 100k\Omega$		2			2		
		$I_Q = 1mA^{(2)}$, $R_L = 10k\Omega$		0.9			0.9		
	Overshoot Factor	$V_{IN} = 50mV$, $C_L = 100pF$ $I_Q = 10\mu A^{(1)}$, $R_L = 1M\Omega$		5			5		%
		$I_Q = 100\mu A$, $R_L = 100k\Omega$		10			10		
		$I_Q = 1mA^{(2)}$, $R_L = 10k\Omega$		40			40		

NOTES: 1. Does not apply to 7641.
2. Does not apply to 7642.
3. ICL7631 only.

For Test Conditions:
C = Commercial Temperature Range: $0^\circ C$ to $+70^\circ C$
M = Military Temperature Range: $-55^\circ C$ to $+125^\circ C$

ELECTRICAL CHARACTERISTICS (7631 AND 7642 ONLY)

($V_{SUPPLY} = \pm 1.0V$, $I_Q = 10\mu A$, $T_A = 25^\circ C$, unless otherwise specified.)

Symbol	Parameter	Test Conditions	76XXC			Units
			Min	Typ	Max	
V_{OS}	Input Offset Voltage	$R_S \leq 100k\Omega$, $T_A = 25^\circ C$ $T_{MIN} \leq T_A \leq T_{MAX}$			10 12	mV
$\Delta V_{OS}/\Delta T$	Temperature Coefficient of V_{OS}	$R_S \leq 100k\Omega$		20		$\mu V/^\circ C$
I_{OS}	Input Offset Current	$T_A = 25^\circ C$ $\Delta T_A = C$		0.5	30 300	pA
I_{BIAS}	Input Bias Current	$T_A = 25^\circ C$ $\Delta T_A = C$		1.0	50 500	pA
V_{CMR}	Common Mode Voltage Range		± 0.6			V

NOTE: All typical values have been characterized but are not tested.

ELECTRICAL CHARACTERISTICS (7631 AND 7642 ONLY) (Continued)

($V_{SUPPLY} = \pm 1.0V$, $I_O = 10\mu A$, $T_A = 25^\circ C$, unless otherwise specified.)

Symbol	Parameter	Test Conditions	76XXC			Units
			Min	Typ	Max	
V_{OUT}	Output Voltage Swing	$R_L = 1M\Omega$, $T_A = 25^\circ C$ $\Delta T_A = C$		± 0.98 ± 0.96		V
A_{VOL}	Large Signal Voltage Gain	$V_O = \pm 0.1V$, $R_L = 1M\Omega$ $T_A = 25^\circ C$ $\Delta T_A = C$		90 80		dB
GBW	Unity Gain Bandwidth			0.044		MHz
R_{IN}	Input Resistance			10^{12}		Ω
CMRR	Common Mode Rejection Ratio	$R_S \leq 100k\Omega$		80		dB
PSRR	Power Supply Rejection Ratio			80		dB
e_n	Input Referred Noise Voltage	$R_S = 100\Omega$, $f = 1kHz$		100		nV/\sqrt{Hz}
i_n	Input Referred Noise Current	$R_S = 100\Omega$, $f = 1kHz$		0.01		pA/\sqrt{Hz}
I_{SUPPLY}	Supply Current (Per Amplifier)	No Signal, No Load		6	15	μA
V_{O1}/V_{O2}	Channel Separation	$A_V = 100$		120		dB
SR	Slew Rate	$A_V = 1$, $C_L = 100pF$ $V_{IN} = 0.2V_{p-p}$ $R_L = 1M\Omega$		0.016		$V/\mu s$
t_r	Rise Time	$V_{IN} = 50mV$, $C_L = 100pF$ $R_L = 1M\Omega$		20		μs
	Overshoot Factor	$V_{IN} = 50mV$, $C_L = 100pF$ $R_L = 1M\Omega$		5		%

NOTE: C = Commercial Temperature Range ($0^\circ C$ to $+70^\circ C$)

NOTE: All typical values have been characterized but are not tested.

TYPICAL PERFORMANCE CHARACTERISTICS

SUPPLY CURRENT PER AMPLIFIER AS A FUNCTION OF SUPPLY VOLTAGE

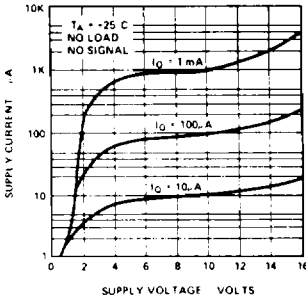

0307-12

SUPPLY CURRENT PER AMPLIFIER AS A FUNCTION OF FREE-AIR TEMPERATURE

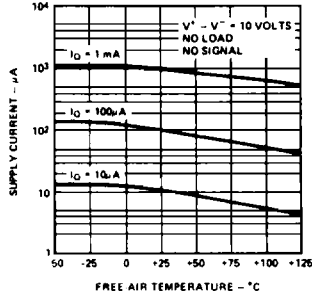

0307-13

INPUT BIAS CURRENT AS A FUNCTION OF TEMPERATURE

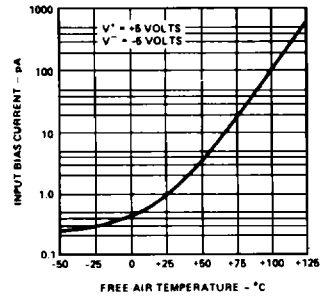

0307-14

LARGE SIGNAL DIFFERENTIAL VOLTAGE GAIN AS A FUNCTION OF FREE-AIR TEMPERATURE

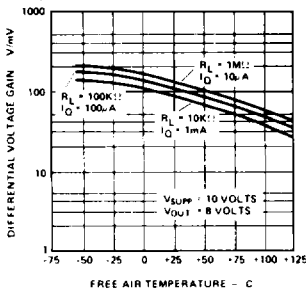

0307-15

LARGE SIGNAL DIFFERENTIAL VOLTAGE GAIN AND PHASE SHIFT AS A FUNCTION OF FREQUENCY

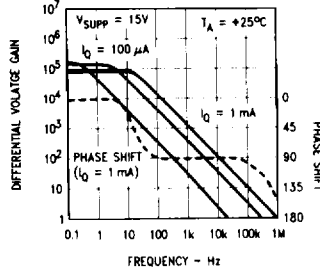

0307-16

COMMON MODE REJECTION RATIO AS A FUNCTION OF FREE-AIR TEMPERATURE

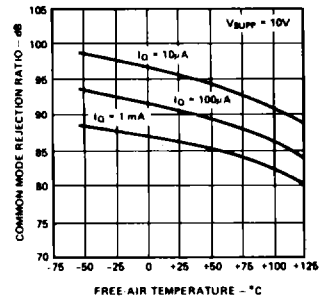

0307-17

POWER SUPPLY REJECTION RATIO AS A FUNCTION OF FREE-AIR TEMPERATURE

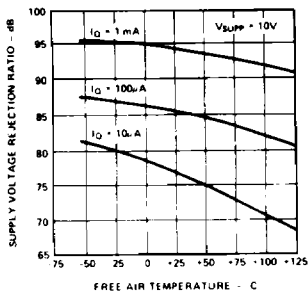

0307-18

EQUIVALENT INPUT NOISE VOLTAGE AS A FUNCTION OF FREQUENCY

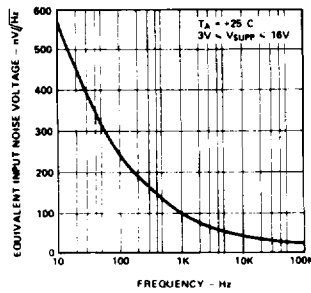

0307-19

PEAK-TO-PEAK OUTPUT VOLTAGE AS A FUNCTION OF FREQUENCY

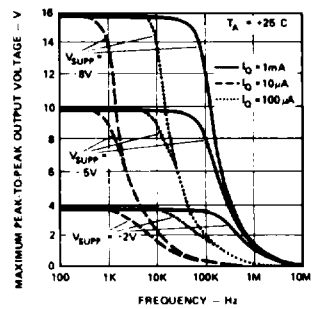

0307-20

NOTE: All typical values have been characterized but are not tested

TYPICAL PERFORMANCE CHARACTERISTICS

MAXIMUM PEAK-TO-PEAK OUTPUT VOLTAGE AS A FUNCTION OF FREQUENCY

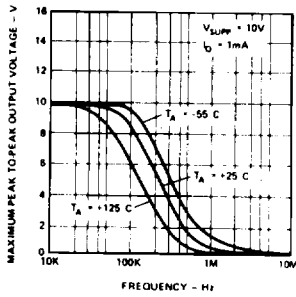

0307-21

MAXIMUM PEAK-TO-PEAK OUTPUT VOLTAGE AS A FUNCTION OF SUPPLY VOLTAGE

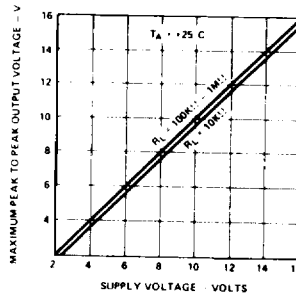

0307-22

MAXIMUM PEAK-TO-PEAK OUTPUT VOLTAGE AS A FUNCTION OF FREE-AIR TEMPERATURE

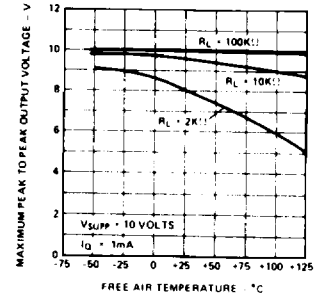

0307-23

MAXIMUM OUTPUT SOURCE CURRENT AS A FUNCTION OF SUPPLY VOLTAGE

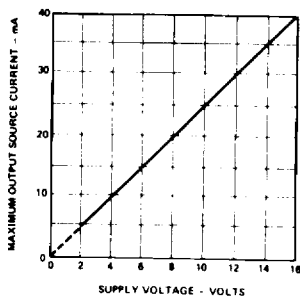

0307-24

MAXIMUM OUTPUT SINK CURRENT AS A FUNCTION OF SUPPLY VOLTAGE

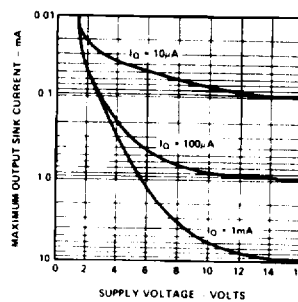

0307-25

MAXIMUM PEAK-TO-PEAK OUTPUT VOLTAGE AS A FUNCTION OF LOAD RESISTANCE

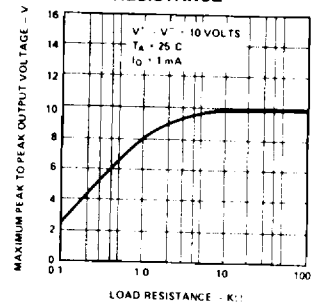

0307-26

VOLTAGE FOLLOWER LARGE SIGNAL PULSE RESPONSE

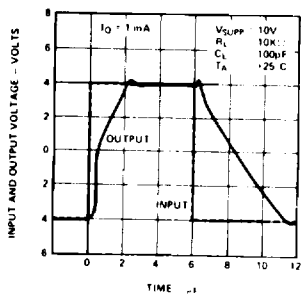

0307-27

VOLTAGE FOLLOWER LARGE SIGNAL PULSE RESPONSE

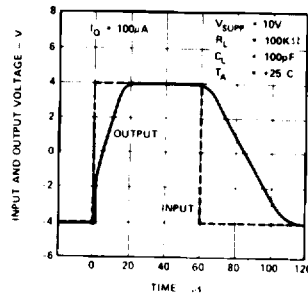

0307-28

VOLTAGE FOLLOWER LARGE SIGNAL PULSE RESPONSE

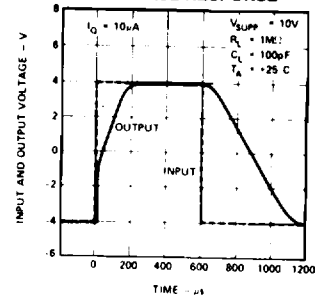

0307-29

NOTE: All typical values have been characterized but are not tested

DETAILED DESCRIPTION

Static Protection

All devices are static protected by the use of input diodes. However, strong static fields should be avoided, as it is possible for the strong fields to cause degraded diode junction characteristics, which may result in increased input leakage currents.

Latchup Avoidance

Junction-isolated CMOS circuits employ configurations which produce a parasitic 4-layer (p-n-p-n) structure. The 4-layer structure has characteristics similar to an SCR, and under certain circumstances may be triggered into a low impedance state resulting in excessive supply current. To avoid this condition, no voltage greater than 0.3V beyond the supply rails may be applied to any pin. In general, the op-amp supplies must be established simultaneously with, or before any input signals are applied. If this is not possible, the drive circuits must limit input current flow to 2mA to prevent latchup.

Choosing the Proper I_Q

Each device in the ICL76XX family has a similar I_Q set-up scheme, which allows the amplifier to be set to nominal quiescent currents of 10 μ A, 100 μ A or 1mA. These current settings change only very slightly over the entire supply voltage range. The ICL7611/12 and ICL7631 have an external I_Q control terminal, permitting user selection of each amplifiers' quiescent current. (The 7621 and 7641/42 have fixed I_Q settings — refer to selector guide for details.) To set the I_Q of programmable versions, connect the I_Q terminal as follows:

$I_Q = 10\mu\text{A}$ — I_Q pin to V^+

$I_Q = 100\mu\text{A}$ — I_Q pin to ground. If this is not possible, any voltage from $V^+ - 0.8$ to $V^- + 0.8$ can be used.

$I_Q = 1\text{mA}$ — I_Q pin to V^-

NOTE: The output current available is a function of the quiescent current setting. For maximum p-p output voltage swings into low impedance loads, I_Q of 1mA should be selected.

Output Stage and Load Driving Considerations

Each amplifiers' quiescent current flows primarily in the output stage. This is approximately 70% of the I_Q settings.

This allows output swings to almost the supply rails for output loads of 1M Ω , 100k Ω , and 10k Ω , using the output stage in a highly linear class A mode. In this mode, crossover distortion is avoided and the voltage gain is maximized. However, the output stage can also be operated in Class AB for higher output currents. (See graphs under Typical Operating Characteristics). During the transition from Class A to Class B operation, the output transfer characteristic is non-linear and the voltage gain decreases.

Input Offset Nulling

For those models provided with OFFSET NULLING pins, nulling may be achieved by connecting a 25K pot between the OFFSET terminals with the wiper connected to V^+ . At quiescent currents of 1mA and 100 μ A, the nulling range provided is adequate for all V_{OS} selections; however with $I_Q = 10\mu\text{A}$, nulling may not be possible with higher values of V_{OS} .

Frequency Compensation

The ICL76XX are internally compensated, and are stable for closed loop gains as low as unity with capacitive loads up to 100pF

Extended Common Mode Input Range

The ICL7612 incorporates additional processing which allows the input CMVR to exceed each power supply rail by 0.1 volt for applications where $V_{SUPP} \geq \pm 1.5V$. For those applications where $V_{SUPP} \leq \pm 1.5V$, the input CMVR is limited in the positive direction, but may exceed the negative supply rail by 0.1 volt in the negative direction (eg. for $V_{SUPP} = \pm 1.0V$, the input CMVR would be +0.6 volts to -1.1 volts).

OPERATION AT $V_{SUPP} = \pm 1.0$ VOLTS

Operation at $V_{SUPP} = \pm 1.0V$ is guaranteed at $I_Q = 10\mu\text{A}$ for A and B grades only. This applies to those devices with selectable I_Q , and devices that are set internally to $I_Q = 10\mu\text{A}$ (i.e., ICL7611, 7612, 7631, 7642).

Output swings to within a few millivolts of the supply rails are achievable for $R_L \geq 1M\Omega$. Guaranteed input CMVR is $\pm 0.6V$ minimum and typically +0.9V to -0.7V at $V_{SUPP} = \pm 1.0V$. For applications where greater common mode range is desirable, refer to the description of ICL7612 above.

NOTE: All typical values have been characterized but are not tested

The user is cautioned that, due to extremely high input impedances, care must be exercised in layout, construction, board cleanliness, and supply filtering to avoid hum and noise pickup.

APPLICATIONS

Note that in no case is I_Q shown. The value of I_Q must be chosen by the designer with regard to frequency response and power dissipation.

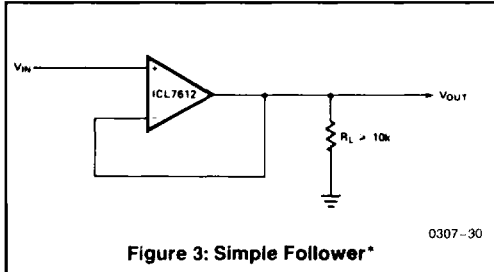
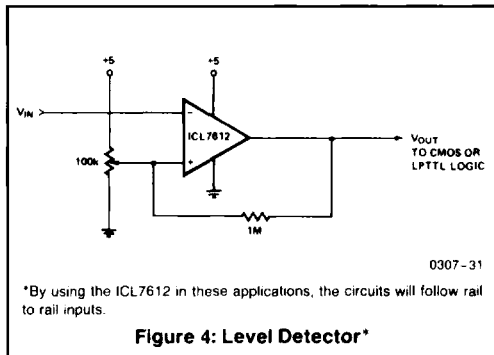
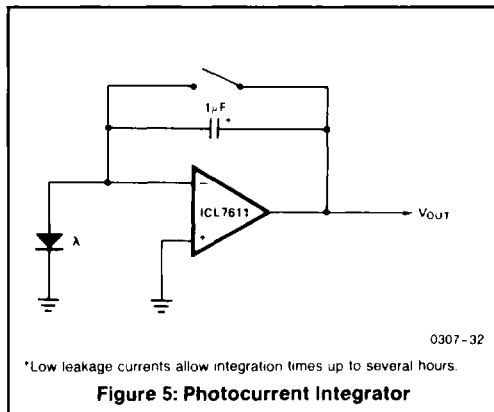

Figure 3: Simple Follower*



*By using the ICL7612 in these applications, the circuits will follow rail to rail inputs.

Figure 4: Level Detector*



*Low leakage currents allow integration times up to several hours.

Figure 5: Photocurrent Integrator

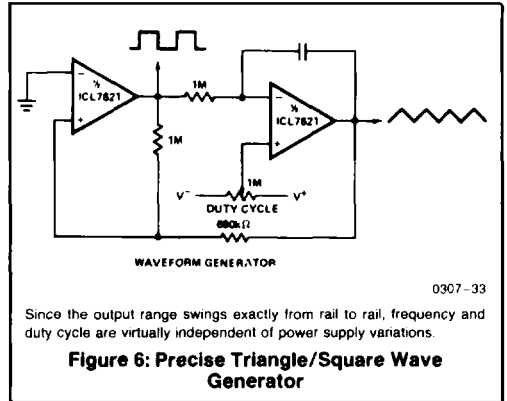

Since the output range swings exactly from rail to rail, frequency and duty cycle are virtually independent of power supply variations.

Figure 6: Precise Triangle/Square Wave Generator

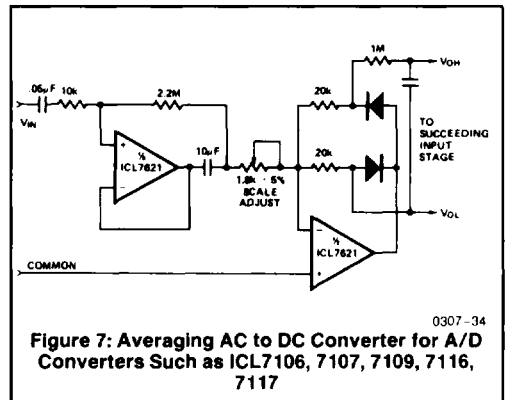
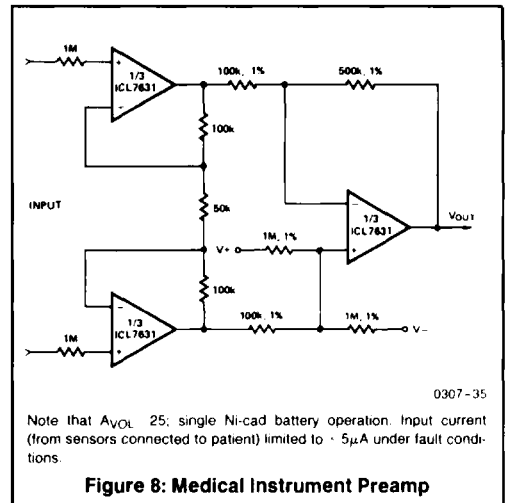

Figure 7: Averaging AC to DC Converter for A/D Converters Such as ICL7106, 7107, 7109, 7116, 7117



Note that $A_{VOL} > 25$; single Ni-cad battery operation. Input current (from sensors connected to patient) limited to $< 5\mu A$ under fault conditions.

Figure 8: Medical Instrument Preamp

NOTE: All typical values have been characterized but are not tested.

ICL76XX

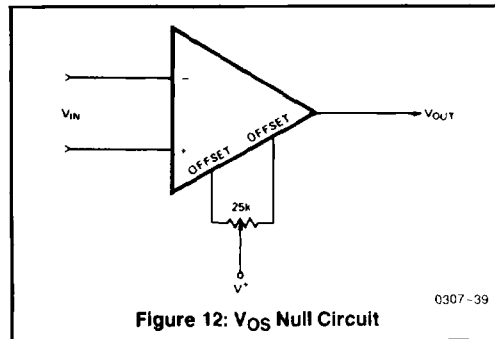
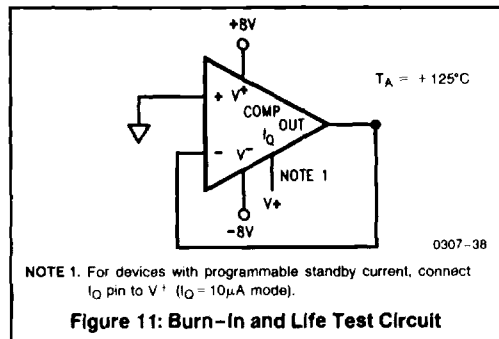
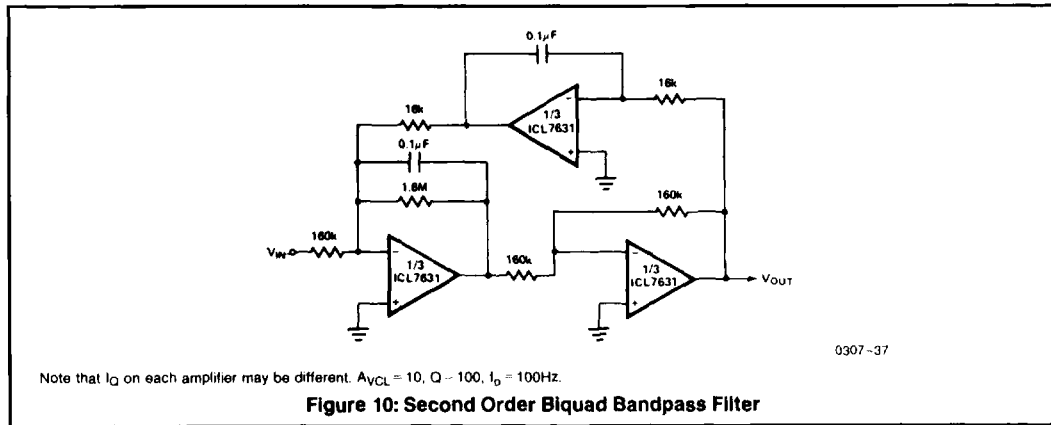
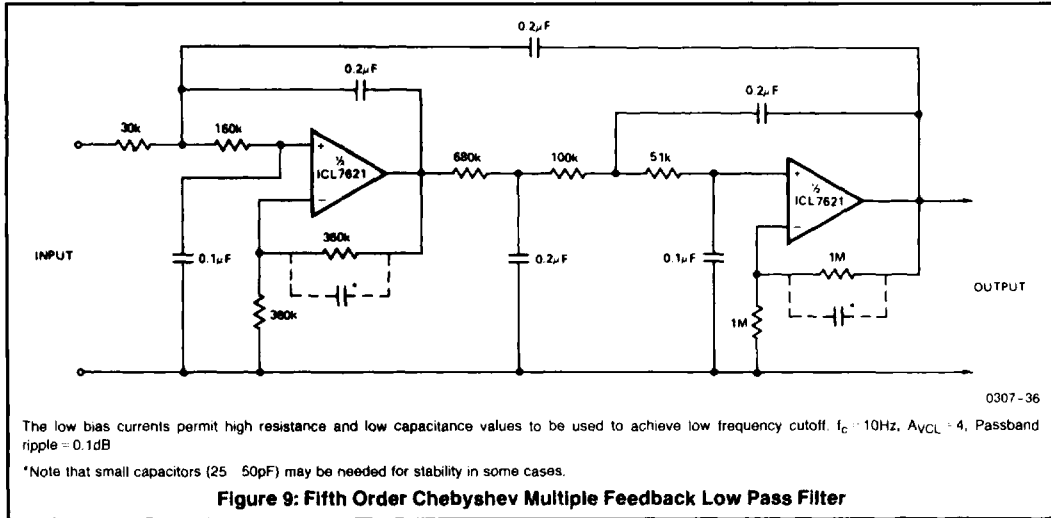

NOTE: All typical values have been characterized but are not tested.