

μA747C, μA747M DUAL GENERAL-PURPOSE OPERATIONAL AMPLIFIERS

D971, FEBRUARY 1971—REVISED OCTOBER 1990

- No Frequency Compensation Required
- Low Power Consumption
- Short-Circuit Protection
- Offset-Voltage Null Capability
- Wide Common-Mode and Differential Voltage Ranges
- No Latch-Up
- Designed to be Interchangeable with Fairchild μA747M and μA747C

description

The μA747 is a dual general-purpose operational amplifier featuring offset-voltage null capability. Each half is electrically similar to μA741.

The high common-mode input voltage range and the absence of latch-up make this amplifier ideal for voltage-follower applications. The device is short-circuit protected and the internal frequency compensation ensures stability without external components. A low-value potentiometer may be connected between the offset null inputs to null out the offset voltage as shown in Figure 2.

The μA747C is characterized for operation from 0°C to 70°C; the μA747M is characterized for operation over the full military temperature range of -55°C to 125°C.

symbol (each amplifier)

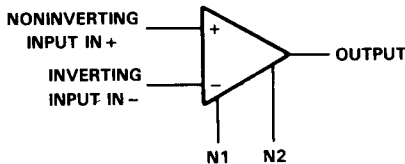

**D, J, N, OR W PACKAGE
(TOP VIEW)**

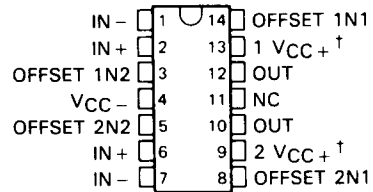

**μA747M . . . FK PACKAGE
(TOP VIEW)**

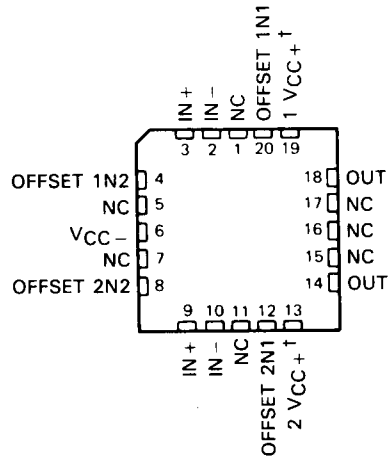

NC—No internal connection

†The two positive supply terminals (1 VCC+ and 2 VCC+) are connected together internally.

AVAILABLE OPTIONS

T _A	V _{IO} MAX AT 25°C	PACKAGE				
		14-PIN				20-PIN
		SMALL OUTLINE (D)	CERAMIC DIP (J)	PLASTIC DIP (N)	FLAT PACK (W)	CHIP CARRIER (FK)
0°C to 70°C	6 mV	μA747CD	—	μA747CN	—	—
-55°C to 125°C	5 mV	—	μA747MJ	—	μA747MW	μA747MFK

The D package is available taped and reeled. Add the suffix R to the device type, (i.e., μA747CDR).

PRODUCTION DATA documents contain information current as of publication date. Products conform to specifications per the terms of Texas Instruments standard warranty. Production processing does not necessarily include testing of all parameters.



POST OFFICE BOX 655303 • DALLAS, TEXAS 75265

Copyright © 1990, Texas Instruments Incorporated

On products compliant to MIL-STD-883, Class B, all parameters are tested unless otherwise noted. On all other products, production processing does not necessarily include testing of all parameters.

uA747C, uA747M DUAL GENERAL-PURPOSE OPERATIONAL AMPLIFIERS

schematic (each amplifier)

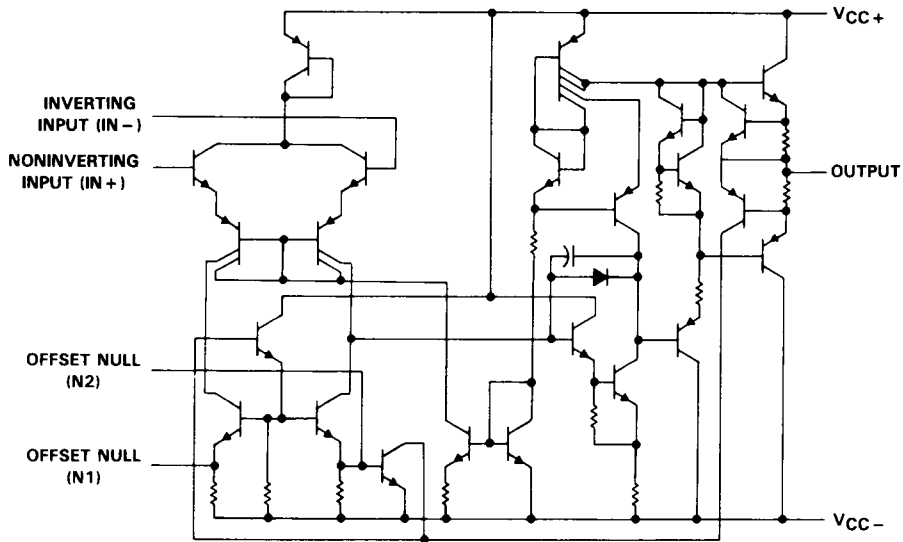

absolute maximum ratings over operating free-air temperature range (unless otherwise noted)

	uA747C	uA747M	UNIT
Supply voltage, V_{CC+} (see Note 1)	18	22	V
Supply voltage, V_{CC-} (see Note 1)	-18	-22	V
Differential input voltage (see Note 2)	± 30	± 30	V
Input voltage any input (see Notes 1 and 3)	± 15	± 15	V
Voltage between any offset null terminal (N1/N2) and V_{CC-}	± 0.5	± 0.5	V
Duration of output short-circuit (see Note 4)	unlimited	unlimited	
Continuous total dissipation	See Dissipation Rating Table		
Operating free-air temperature range	0 to 70	-55 to 125	$^{\circ}\text{C}$
Storage temperature range	-65 to 150	-65 to 150	$^{\circ}\text{C}$
Case temperature for 60 seconds	FK package	260	$^{\circ}\text{C}$
Lead temperature 1,6 mm (1/16 inch) from case for 60 seconds	J or W package	300	$^{\circ}\text{C}$
Lead temperature 1,6 mm (1/16 inch) from case for 10 seconds	D or N package	260	$^{\circ}\text{C}$

- NOTES: 1. All voltage values, unless otherwise noted, are with respect to the midpoint between V_{CC+} and V_{CC-} .
 2. Differential voltages are at the noninverting input terminal with respect to the inverting input terminal.
 3. The magnitude of the input voltage must never exceed the magnitude of the supply voltage or 15 V, whichever is less.
 4. The output may be shorted to ground or either power supply. For the uA747M only, the unlimited duration of the short-circuit applies at (or below) 125 $^{\circ}\text{C}$ case temperature or 75 $^{\circ}\text{C}$ free-air temperature.

DISSIPATION RATING TABLE

PACKAGE	$T_A \leq 25^{\circ}\text{C}$	DERATING FACTOR	DERATE ABOVE T_A	$T_A = 70^{\circ}\text{C}$	$T_A = 125^{\circ}\text{C}$
	POWER RATING			POWER RATING	POWER RATING
D	800 mW	7.6 mW/ $^{\circ}\text{C}$	45 $^{\circ}\text{C}$	608 mW	—
FK	800 mW	11.0 mW/ $^{\circ}\text{C}$	77 $^{\circ}\text{C}$	800 mW	275 mW
J	800 mW	11.0 mW/ $^{\circ}\text{C}$	77 $^{\circ}\text{C}$	800 mW	275 mW
N	800 mW	9.2 mW/ $^{\circ}\text{C}$	63 $^{\circ}\text{C}$	736 mW	—
W	800 mW	8.0 mW/ $^{\circ}\text{C}$	50 $^{\circ}\text{C}$	640 mW	200 mW

uA747C, uA747M

DUAL GENERAL-PURPOSE OPERATIONAL AMPLIFIERS

electrical characteristics at specified free-air temperature, $V_{CC+} = 15\text{ V}$, $V_{CC-} = -15\text{ V}$

PARAMETER	TEST CONDITIONS†	uA747C			uA747M			UNIT
		MIN	TYP	MAX	MIN	TYP	MAX	
V_{IO} Input offset voltage	$V_O = 0$	25°C	1	6	1	5	mV	
		Full range	7.5					
$\Delta V_{IO(\text{adj})}$ Offset voltage adjust range		25°C	±15		±15		mV	
I_{IO} Input offset current		25°C	20	200	20	200	nA	
		Full range	300			500		
I_{IB} Input bias current		25°C	80	500	80	500	nA	
		Full range	800			1500		
V_{ICR} Common-mode input voltage range		25°C	±12	±13	±12	±13	V	
		Full range	±12					
V_{OPP} Maximum peak-to-peak output voltage swing	$R_L = 10\text{ k}\Omega$	25°C	24	28	24	28	V	
	$R_L \geq 10\text{ k}\Omega$	Full range	24					
	$R_L = 2\text{ k}\Omega$	25°C	20	26	20	26		
	$R_L \geq 2\text{ k}\Omega$	Full range	20					
A_{VD} Large-signal differential voltage amplification	$R_L \geq 2\text{ k}\Omega$, $V_O = \pm 10\text{ V}$	25°C	25	200	50	200	V/mV	
		Full range	15			25		
r_i Input resistance		25°C	0.3*	2	0.3	2	M Ω	
r_o Output resistance	See Note 6	25°C	75			75	Ω	
C_i Input capacitance		25°C	1.4			1.4	pF	
CMRR Common-mode rejection ratio	$V_{IC} = V_{ICR}$	25°C	70	90	70	90	dB	
		Full range	70					
k_{SVS} Supply voltage sensitivity ($\Delta V_{IO}/\Delta V_{CC}$)	$V_{CC} = \pm 9\text{ V to } \pm 15\text{ V}$	25°C	30	150	30	150	$\mu\text{V/V}$	
		Full range	150					
I_{OS} Short-circuit output current		25°C	±25	±40	±25	±40	mA	
I_{CC} Supply current (each amplifier)	No load	25°C	1.7	2.8	1.7	2.8	mA	
		Full range	3.3					
P_D Power dissipation (each amplifier)	No load, $V_O = 0$	25°C	50	85	50	85	mW	
		Full range	100					
V_{O1}/V_{O2} Channel separation		25°C	120		120	0	dB	

† All characteristics are measured under open-loop conditions with zero common-mode input voltage unless otherwise specified. Full range for uA747C is 0°C to 70°C and for uA747M is -55°C to 125°C.

* On products compliant to MIL-STD-883, Class B, this parameter is not production tested.

NOTE 6: This typical value applies only at frequencies above a few hundred hertz because of the effects of drift and thermal feedback.

operating characteristics, $V_{CC+} = 15\text{ V}$, $V_{CC-} = -15\text{ V}$, $T_A = 25^\circ\text{C}$

PARAMETER	TEST CONDITIONS	MIN	TYP	MAX	UNIT
t_r Rise time	$V_I = 20\text{ mV}$, $R_L = 2\text{ k}\Omega$,		0.3		μs
Overshoot factor	$C_L = 100\text{ pF}$, See Figure 1		5%		
SR Slew rate at unity gain	$V_I = 10\text{ V}$, $R_L = 2\text{ k}\Omega$, $C_L = 100\text{ pF}$, See Figure 1		0.5		V/ μs



uA747C, uA747M
DUAL GENERAL-PURPOSE OPERATIONAL AMPLIFIERS

PARAMETER MEASUREMENT INFORMATION

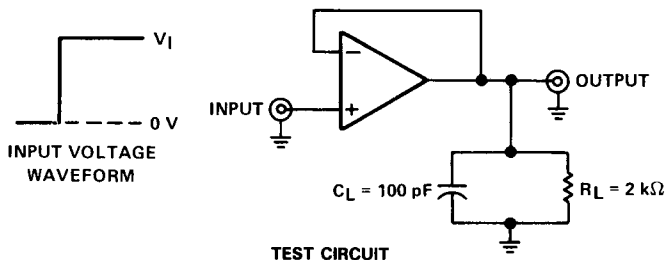

FIGURE 1. RISE TIME, OVERSHOOT, AND SLEW RATE

TYPICAL APPLICATION DATA

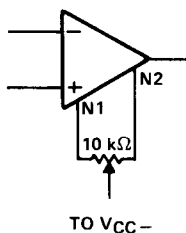

FIGURE 2. INPUT OFFSET VOLTAGE NULL CIRCUIT

TYPICAL CHARACTERISTICS

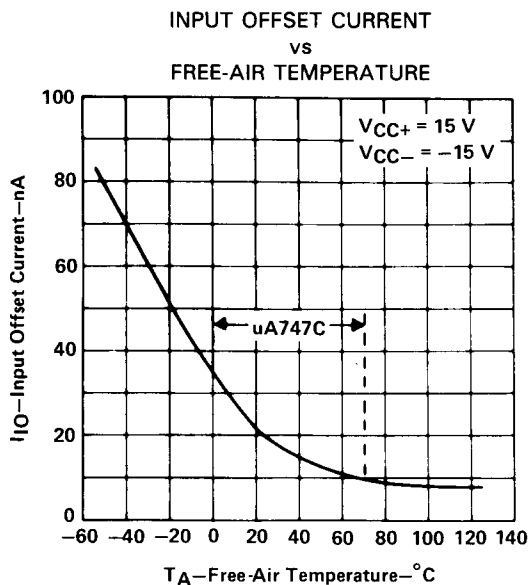

FIGURE 3

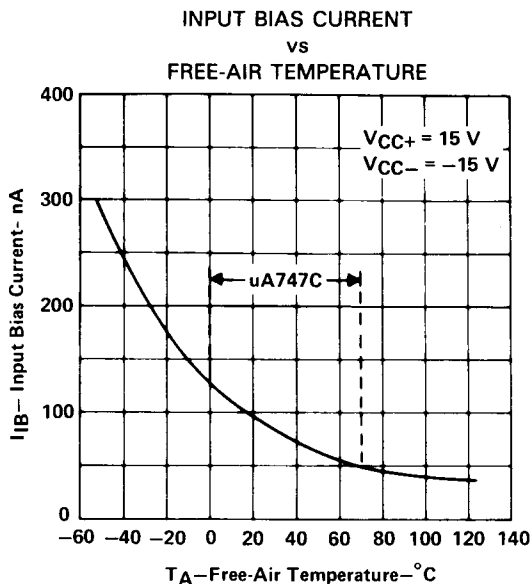

FIGURE 4

TYPICAL CHARACTERISTICS

MAXIMUM PEAK-TO-PEAK
OUTPUT VOLTAGE
vs
LOAD RESISTANCE

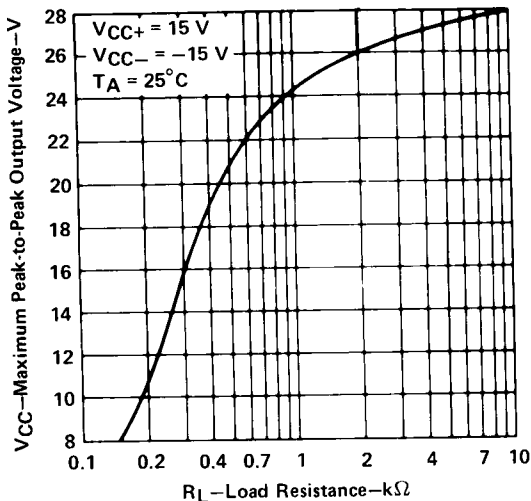

FIGURE 5

MAXIMUM PEAK-TO-PEAK
OUTPUT VOLTAGE
vs
FREQUENCY

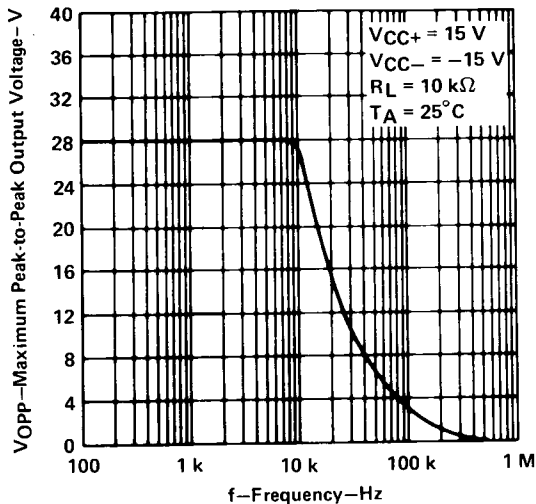

FIGURE 6

OPEN-LOOP LARGE-SIGNAL
DIFFERENTIAL
VOLTAGE AMPLIFICATION
vs
SUPPLY VOLTAGE

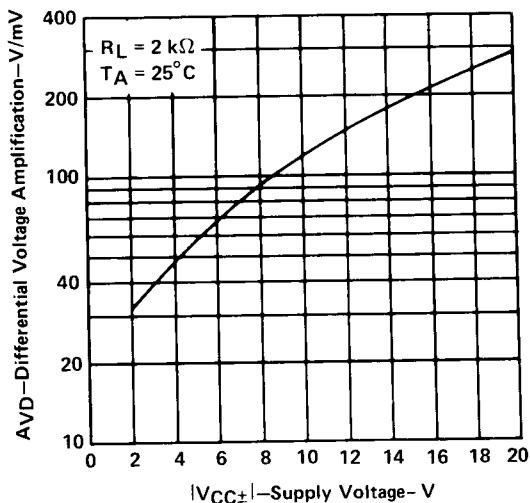

FIGURE 7

OPEN-LOOP LARGE-SIGNAL
DIFFERENTIAL
VOLTAGE AMPLIFICATION
vs
FREQUENCY

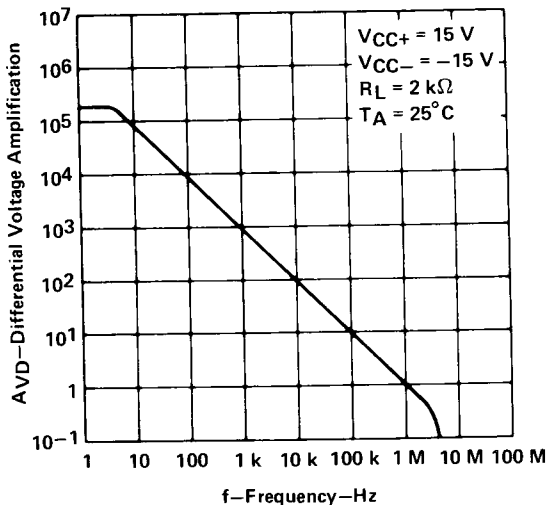

FIGURE 8

TYPICAL CHARACTERISTICS

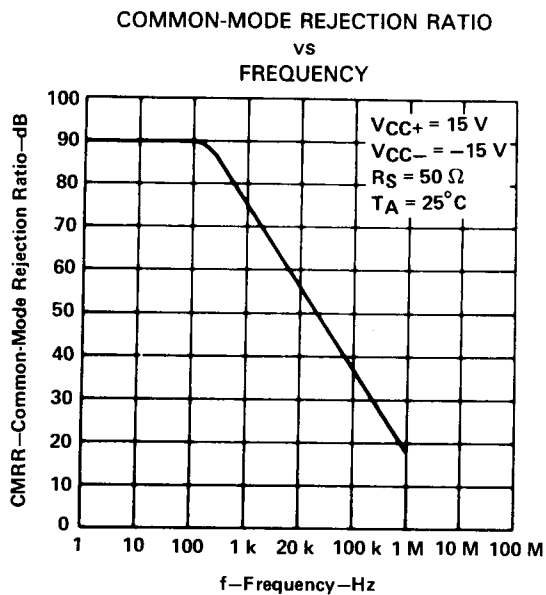

FIGURE 9

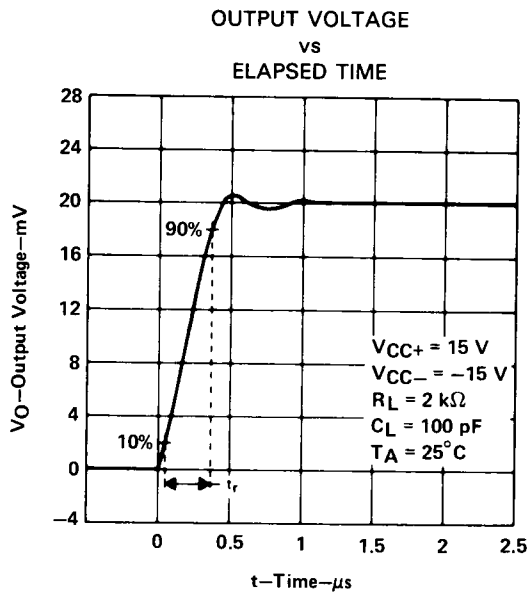

FIGURE 10

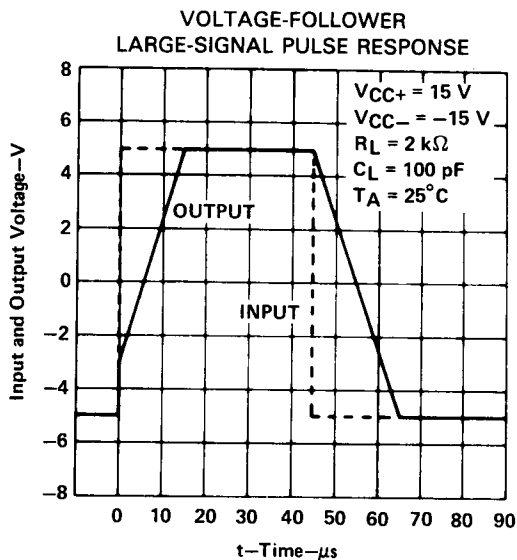

FIGURE 11