

Advanced Regulating Pulse Width Modulators

FEATURES

- Fully Interchangeable with Standard UC1524 Family
- Precision Reference Internally Trimmed to $\pm 1\%$
- High-Performance Current Limit Function
- Under-Voltage Lockout with Hysteretic Turn-on
- Start-Up Supply Current Less Than 4mA
- Output Current to 200mA
- 60V Output Capability
- Wide Common-Mode Input Range for both Error and Current Limit Amplifiers
- PWM Latch Insures Single Pulse per Period
- Double Pulse Suppression Logic
- 200ns Shutdown through PWM Latch
- Guaranteed Frequency Accuracy
- Thermal Shutdown Protection

DESCRIPTION

The UC1524A family of regulating PWM ICs has been designed to retain the same highly versatile architecture of the industry standard UC1524 (SG1524) while offering substantial improvements to many of its limitations. The UC1524A is pin compatible with "non-A" models and in most existing applications can be directly interchanged with no effect on power supply performance. Using the UC1524A, however, frees the designer from many concerns which typically had required additional circuitry to solve.

The UC1524A includes a precise 5V reference trimmed to $\pm 1\%$ accuracy, eliminating the need for potentiometer adjustments; an error amplifier with an input range which includes 5V, eliminating the need for a reference divider; a current sense amplifier useful in either the ground or power supply output lines; and a pair of 60V, 200mA uncommitted transistor switches which greatly enhance output versatility.

An additional feature of the UC1524A is an under-voltage lockout circuit which disables all the internal circuitry, except the reference, until the input voltage has risen to 8V. This holds standby current low until turn-on, greatly simplifying the design of low power, off-line supplies. The turn-on circuit has approximately 600mV of hysteresis for jitter-free activation.

Other product enhancements included in the UC1524A's design include a PWM latch which insures freedom from multiple pulsing within a period, even in noisy environments, logic to eliminate double pulsing on a single output, a 200ns external shutdown capability, and automatic thermal protection from excessive chip temperature. The oscillator circuit of the UC1524A is usable beyond 500kHz and is now easier to synchronize with an external clock pulse.

The UC1524A is packaged in a hermetic 16-pin DIP and is rated for operation from -55°C to $+125^{\circ}\text{C}$. The UC2524A and 3524A are available in either ceramic or plastic packages and are rated for operation from -25°C to $+85^{\circ}\text{C}$ and 0°C to 70°C , respectively. Surface mount devices are also available.

BLOCK DIAGRAM

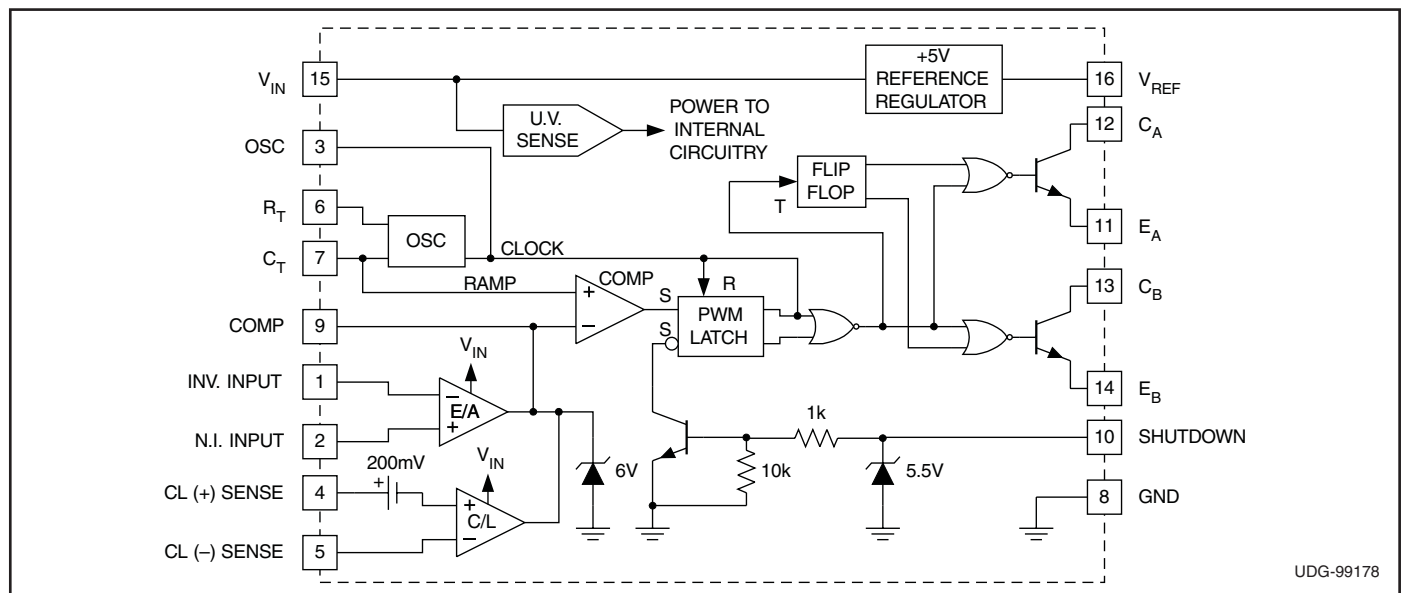

UDG-99178

ABSOLUTE MAXIMUM RATINGS

Supply Voltage (VIN) 40V
 Collector Supply Voltage (Vc) 60V
 Output Current (each Output) 200mA
 Maximum Forced Voltage (Pin 9, 10) -3 to +5V
 Maximum Forced Current (Pin 9, 10) ±10mA
 Reference Output Current 50mA
 Oscillator Charging Current 5mA
 Power Dissipation at TA = +25°C 1000mW
 Power Dissipation at Tc = +25°C 2000mW
 Operating Temperature Range -55°C to +125°C
 Storage Temperature Range -65°C to +150°C
 Lead Temperature, (Soldering, 10 seconds) +300°C
Note: Consult packaging section of Databook for thermal limitations and considerations of package.

CONNECTION DIAGRAMS

**PLCC-20, LCC-20 (TOP VIEW)
Q or L Package**

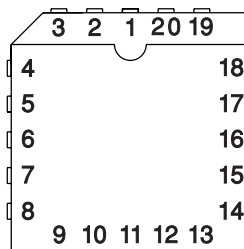

PACKAGE PIN FUNCTION	
FUNCTION	PIN
N/C	1
Inv. Input	2
Non-Inv. Input	3
OSC/SYNC	4
C.L. (+) sense	5
N/C	6
C.L. (-) sense	7
RT	8
CT	9
Ground	10
N/C	11
Compensation	12
Shutdown	13
Emitter A	14
Collector A	15
N/C	16
Collector B	17
Emitter B	18
+VIN	19
+5V VREF	20

**DIL-16, SOIC-16 (TOP VIEW)
J or N Package, DW Package**

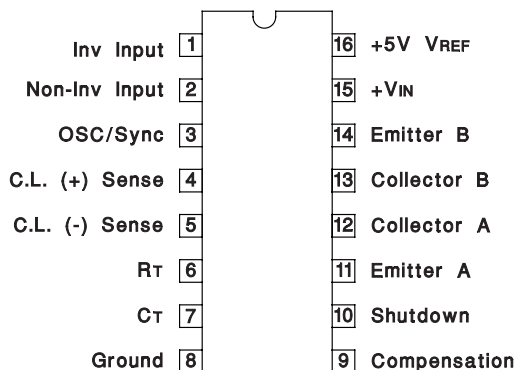

ELECTRICAL CHARACTERISTICS: Unless otherwise stated, these specifications apply for TA = -55°C to +125°C for the UC1524A, -25° to +85°C for the UC2524A, and 0°C to + 70°C for the UC3524A; VIN = Vc = 20V, TA = TJ.

PARAMETER	TEST CONDITIONS	UC1524A / UC2524A			UC3524A			UNITS
		MIN	TYP	MAX	MIN	TYP	MAX	
Turn-on Characteristics								
Input Voltage	Operating Range after Turn-on	8		40	8		40	V
Turn-on Threshold		6.5	7.5	8.5	6.5	7.5	8.5	V
Turn-on Current	VIN = 6V		2.5	4		2.5	4	mA
Operating Current	VIN = 8 to 40V		5	10		5	10	mA
Turn-on Hysteresis*			0.5			0.5		V
Reference Section								
Output Voltage	TJ = 25°C	4.95	5.00	5.05	4.90	5.00	5.10	V
	Over Operating Range	4.9		5.1	4.85		5.15	V
Line Regulation	VIN = 10 to 40V		10	20		10	30	mV
Load Regulation	IL = 0 to 20 mA		20	25		20	35	mV
Temperature Stability*	Over Operating Range*		20	25		20	35	mV
Short Circuit Current	VREF = 0, 25°C ≤ TJ ≤ 125°C		80	100		80	100	mA
Output Noise Voltage*	10Hz ≤ f ≤ 10kHz, TJ = 25°C		40			40		µVrms
Long Term Stability*	TJ = 125°C, 1000 Hrs.		20	50		20	50	mV

* These parameters are guaranteed by design but not 100% tested in production.

ELECTRICAL CHARACTERISTICS: Unless otherwise stated, these specifications apply for $T_A = -55^{\circ}\text{C}$ to $+125^{\circ}\text{C}$ for the UC1524A, -25° to $+85^{\circ}\text{C}$ for the UC2524A, and 0°C to $+70^{\circ}\text{C}$ for the UC3524A; $V_{IN} = V_C = 20\text{V}$, $T_A = T_J$.

PARAMETER	TEST CONDITIONS	UC1524A / UC2524A			UC3524A			UNITS
		MIN	TYP	MAX	MIN	TYP	MAX	
Oscillator Section (Unless otherwise specified, $R_T = 2700\Omega$, $C_T = 0.01\text{ mfd}$)								
Initial Accuracy	$T_J = 25^{\circ}\text{C}$	41	43	45	39	43	47	kHz
	Over Operating Range	40.2		45.9	38.2		47.9	kHz
Temperature Stability*	Over Operating Temperature Range		1	2		1	2	%
Minimum Frequency	$R_T = 150\text{k}\Omega$, $C_T = 0.1\text{ mfd}$			140			120	Hz
Maximum Frequency	$R_T = 2.0\text{k}\Omega$, $C_T = 470\text{pF}$	500			500			kHz
Output Amplitude*		3	3.5		3	3.5		V
Output Pulse Width*		0.29	0.5	1.0	0.3	0.5	1.0	μs
Ramp Peak		3.3	3.5	3.7	3.3	3.5	3.7	V
Ramp Valley	$T_J = 25^{\circ}\text{C}$	0.7	0.8	0.9	0.7	0.8	0.9	V
Ramp Valley T.C.			-1.0			-1.0		$\text{mV}/^{\circ}\text{C}$
Error Amplifier Section (Unless otherwise specified, $V_{CM} = 2.5\text{V}$)								
Input Offset Voltage			0.5	5		2	10	mV
Input Bias Current			1	5		1	10	μA
Input Offset Current			.05	1		0.5	1	μA
Common Mode Rejection Ratio	$V_{CM} = 1.5$ to 5.5V	70	80		70	80		dB
Power Supply Rejection Ratio	$V_{IN} = 10$ to 40V	70	80		70	80		dB
Output Swing (Note 1)		5.0		0.5	5.0		0.5	V
Open Loop Voltage Gain	$\Delta V_O = 1$ to 4V , $R_L \geq 10\text{M}\Omega$	72	80		64	80		dB
Gain-Bandwidth*	$T_J = 25^{\circ}\text{C}$, $A_V = 0\text{dB}$	1	3		1	3		MHz
DC Transconductance*§	$T_J = 25^{\circ}\text{C}$, $30\text{k}\Omega \leq R_L \leq 1\text{M}\Omega$	1.7	2.3		1.7	2.3		mS
P.W.M. Comparator ($R_T = 2\text{k}\Omega$, $C_T = 0.01\text{ mfd}$)								
Minimum Duty Cycle	$V_{COMP} = 0.5\text{V}$			0			0	%
Maximum Duty Cycle	$V_{COMP} = 3.8\text{V}$	45			45			%
Current Limit Amplifier (Unless otherwise specified, Pin 5 = 0V)								
Input Offset Voltage	$T_J = 25^{\circ}\text{C}$, E/A Set for Maximum Output	190	200	210	180	200	220	mV
	Over Operating Temperature Range	180		220	170		230	mV
Input Bias Current			-1	-10		-1	-10	μA
Common Mode Rejection Ratio	$V_{(\text{pin } 5)} = -0.3\text{V}$ to $+5.5\text{V}$	50	60		50	60		dB
Power Supply Rejection Ratio	$V_{IN} = 10$ to 40V	50	60		50	60		dB
Output Swing (Note 1)	Minimum Total Range	5.0		0.5	5.0		0.5	V
Open-Loop Voltage Gain	$\Delta V_O = 1$ to 4V , $R_L \geq 10\text{M}\Omega$	70	80		70	80		dB
Delay Time*	Pin 4 to Pin 9, $\Delta V_{IN} = 300\text{mV}$		300			300		ns
Output Section (Each Output)								
Collector Emitter Voltage	$I_C = 100\mu\text{A}$	60	80		60	80		V
Collector Leakage Current	$V_{CE} = 50\text{V}$.1	20		.1	20	μA

* These parameters are guaranteed by design but not 100% tested in production.

§ DC transconductance (gm) relates to DC open-loop voltage gain according to the following equation: $A_V = gmR_L$ where R_L is the resistance from pin 9 to the common mode voltage.

The minimum gm specification is used to calculate minimum A_V when the error amplifier output is loaded.

Note 1: Min Limit applies to output high level, max limit applies to output low level.

ELECTRICAL CHARACTERISTICS: Unless otherwise stated, these specifications apply for $T_A = -55^\circ\text{C}$ to $+125^\circ\text{C}$ for the UC1524A, -25° to $+85^\circ\text{C}$ for the UC2524A, and 0°C to $+70^\circ\text{C}$ for the UC3524A; $V_{IN} = V_C = 20\text{V}$. $T_A = T_J$.

PARAMETER	TEST CONDITIONS	UC1524A / UC2524A			UC3524A			UNITS
		MIN	TYP	MAX	MIN	TYP	MAX	
Output Section (cont.) (Each Output)								
Saturation Voltage	$I_C = 20\text{mA}$ $I_C = 200\text{mA}$.2 1	.4 2.2		.2 1	.4 2.2	V V
Emitter Output Voltage	$I_E = 50\text{mA}$	17	18		17	18		V
Rise Time*	$T_J = 25^\circ\text{C}$, $R = 2\text{k}\Omega$		120	400		120	400	ns
Fall Time*	$T_J = 25^\circ\text{C}$, $R = 2\text{k}\Omega$		25	200		25	200	ns
Comparator Delay*	$T_J = 25^\circ\text{C}$, Pin 9 to output		300			300		ns
Shutdown Delay*	$T_J = 25^\circ\text{C}$, Pin 10 to output		200			200		ns
Shutdown Threshold	$T_J = 25^\circ\text{C}$, $R_C = 2\text{k}\Omega$	0.6	.7	1.0	0.6	.7	1.0	V
S/D Threshold Over Temp.	Over Operating Temperature Range	0.4		1.2	0.4		1.0	V
Thermal Shutdown*			165			165		$^\circ\text{C}$

* These parameters are guaranteed by design but not 100% tested in production.

OPEN-LOOP CIRCUIT

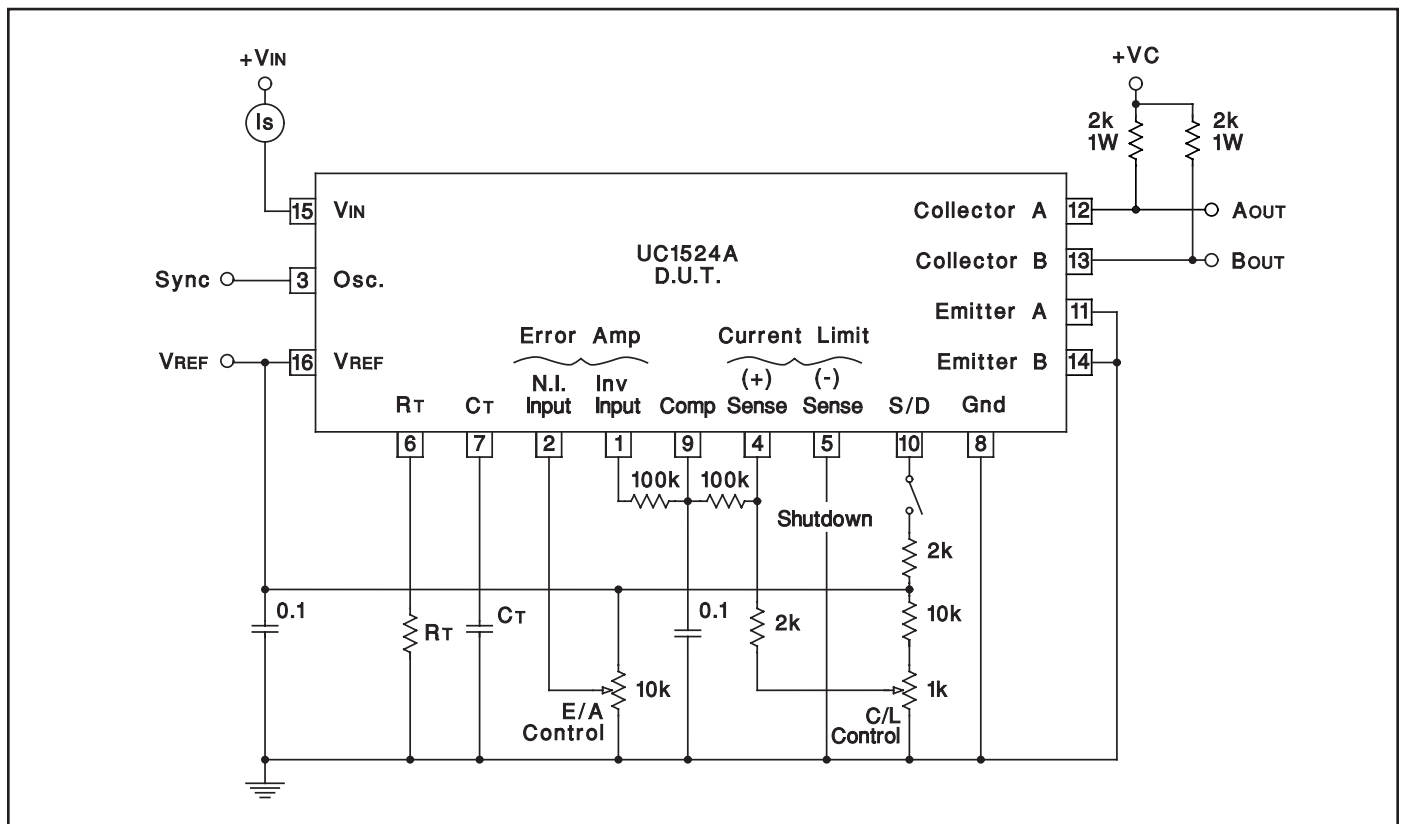

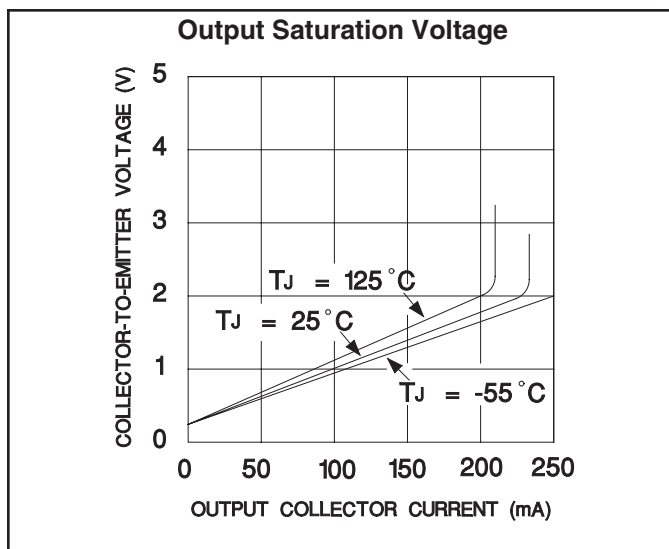
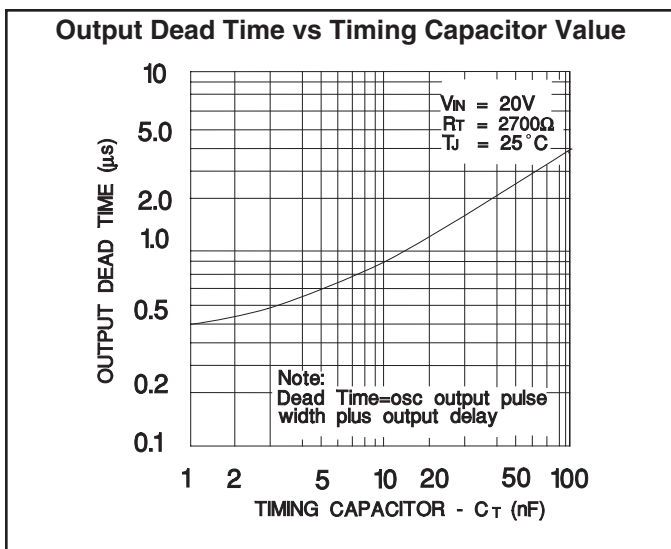
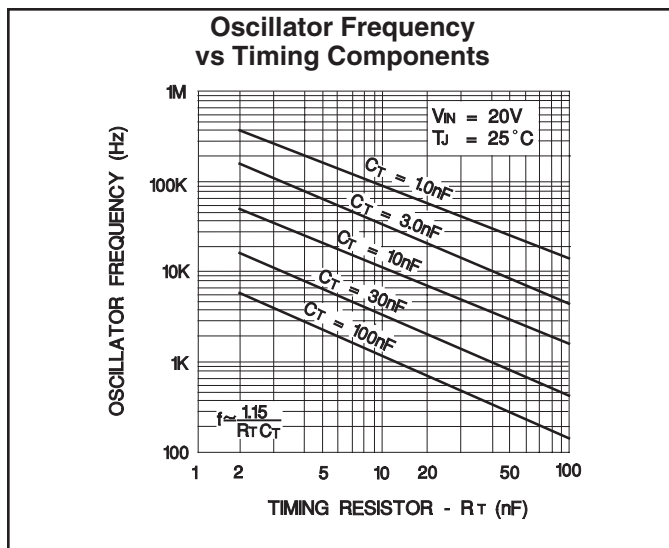
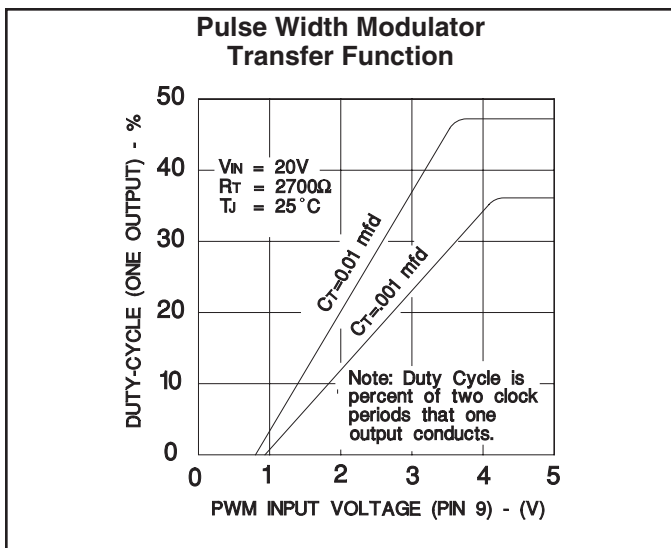
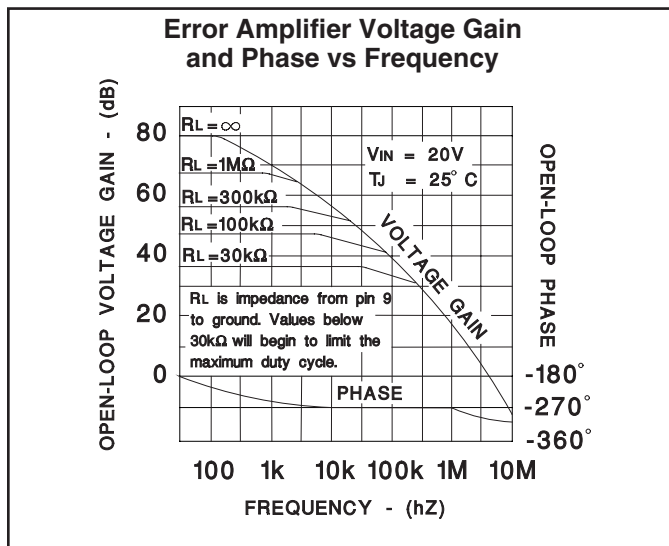
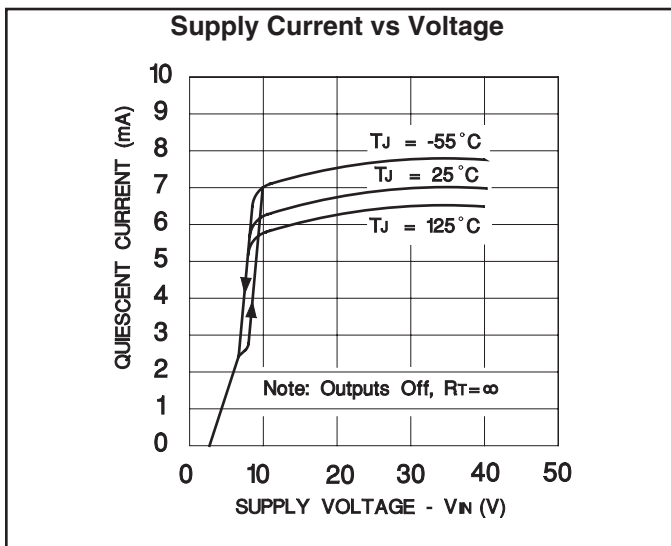

Current Limit Amplifier Delay

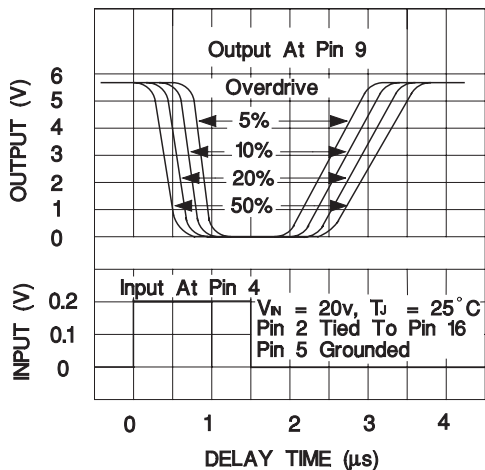

Shutdown Delay From PWM Comparator - Pin 9

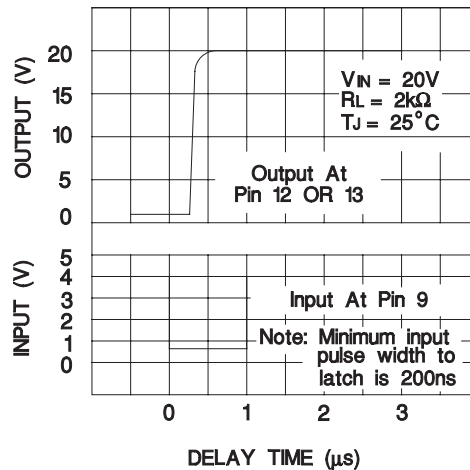

Turn-Off Delay From Shutdown - Pin 10

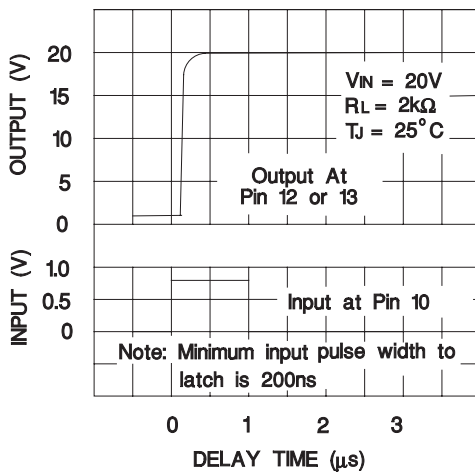

Texas Instruments		Semiconductors			
Search	Tech Support	Comments	Site Map	TI&ME	Home
Products		Development Tools		Applications	
Products					

>> [Semiconductor Home](#) > [Products](#) > [Analog & Mixed-Signal](#) > [Power Management](#) > [Switching Power Supply Controllers](#) > [Voltage Mode](#) >

UC1524A, ADVANCED REGULATING PULSE WIDTH MODULATORS

Device Status: Active

- > [Description](#)
- > [Features](#)
- > [Datasheets](#)
- > [Pricing/Samples/Availability](#)
- > [Application Notes](#)
- > [Development Tools](#)
- > [Applications](#)

Parameter Name	UC1524A
Shutdown	Yes
Pulse - by - Pulse Isense	No
Vsupply Operating Range (V)	8 - 40
Output Type	Dual Alternating, Uncommitted
Output Current (mA)	200
Frequency (max) (kHz)	500
Reference Voltage (V)	5
Vref tol (%)	1
Duty Cycle (max) (%)	50/50
Undervoltage Lockout	Yes
On-board Amplifiers	1
Output Mode Fixed Push - Pull	Yes
Output Mode Single - Ended	Yes
Programmable Outputs	No
Current - Sense Amplifiers	1
Dead Time Control	No

Description

The UC1524A family of regulating PWM ICs has been designed to retain the same highly versatile architecture of the industry standard UC1524 (SG1524) while offering substantial improvements to many of its limitations. The UC1524A is pin compatible with “non-A” models and in most existing applications can be directly interchanged with no effect on power supply performance. Using the UC1524A, however, frees the designer from many concerns which typically had required additional circuitry to solve.

The UC1524A includes a precise 5V reference trimmed to $\pm 1\%$ accuracy, eliminating the need for potentiometer adjustments; an error amplifier with an input range which includes 5V, eliminating the need for a reference divider; a

current sense amplifier useful in either the ground or power supply output lines; and a pair of 60V, 200mA uncommitted transistor switches which greatly enhance output versatility.

An additional feature of the UC1524A is an under-voltage lockout circuit which disables all the internal circuitry, except the reference, until the input voltage has risen to 8V. This holds standby current low until turn-on, greatly simplifying the design of low power, off-line supplies. The turn-on circuit has approximately 600mV of hysteresis for jitter-free activation.

Other product enhancements included in the UC1524A's design include a PWM latch which insures freedom from multiple pulsing within a period, even in noisy environments, logic to eliminate double pulsing on a single output, a 200ns external shutdown capability, and automatic thermal protection from excessive chip temperature. The oscillator circuit of the UC1524A is usable beyond 500kHz and is now easier to synchronize with an external clock pulse.

The UC1524A is packaged in a hermetic 16-pin DIP and is rated for operation from -55°C to +125°C. The UC2524A and 3524A are available in either ceramic or plastic packages and are rated for operation from -25°C to +85°C and 0°C to 70°C, respectively. Surface mount devices are also available.

Features

- Fully Interchangeable with Standard UC1524 Family
- Precision Reference Internally Trimmed to $\pm 1\%$
- High-Performance Current Limit Function
- Under-Voltage Lockout with Hysteretic Turn-on
- Start-Up Supply Current Less Than 4mA
- Output Current to 200mA
- 60V Output Capability
- Wide Common-Mode Input Range for both Error and Current Limit Amplifiers
- PWM Latch Insures Single Pulse per Period
- Double Pulse Suppression Logic
- 200ns Shutdown through PWM Latch
- Guaranteed Frequency Accuracy
- Thermal Shutdown Protection

To view the following documents, [Acrobat Reader 3.x](#) is required.

To download a document to your hard drive, right-click on the link and choose 'Save'.

Datasheets

Full datasheet in Acrobat PDF: [slus181a.pdf](#) (365 KB)

Full datasheet in Zipped PostScript: [slus181a.psz](#) (527 KB)

Pricing/Samples/Availability

Orderable Device	Package	Pins	Temp (°C)	Status	Price/unit USD (100-999)	Pack Qty	DSCC Number	Availability / Samples
5962-8764502EA	J	16	-55 TO 125	ACTIVE	23.31	1		Check stock or order
UC1524AJ	UTR	16	-55 TO 125	ACTIVE	8.02	1		Check stock or order
UC1524AJ883B	UTR	16	-55 TO 125	ACTIVE	18.97	1	5962-8989901EA	Check stock or order
UC1524AL	UTR	20	-55 TO 125	ACTIVE	26.25	1		Check stock or order
UC1524AL/883B	L	20	-55 TO 125	ACTIVE	43.77	1	5962-8670402XA	Check stock or order

Application Reports

- [ANALOG APPLICATIONS JOURNAL, FEBRUARY 2000](#) (SLYT012A - Updated: 03/23/2000)
- [ANALOG APPLICATIONS JOURNAL, NOVEMBER 1999](#) (SLYT010A - Updated: 03/23/2000)
- [ELECTROSTATIC DISCHARGE APPLICATION NOTE](#) (SSYA008 - Updated: 05/05/1999)
- [THERMAL CHARACTERISTICS OF LINEAR AND LOGIC PACKAGES USING JEDEC PCB DESIGNS](#) (SZZA017A - Updated: 09/15/1999)

Table Data Updated on: 6/16/2000

[Search](#)
[Tech Support](#)
[Comments](#)
[Site Map](#)
[TI&ME](#)
[Home](#)

[\(c\) Copyright](#) 2000 Texas Instruments Incorporated. All rights reserved.
[Trademarks](#), [Important Notice!](#), [Privacy Policy](#)