

**FEATURES**

- InGaP HBT Technology
- High Efficiency: 36.5% (Low Bias Mode)
- Low Quiescent Current: 61 mA
- No Mode Switching Required
- Low Leakage Current in Shutdown Mode: <math><1 \mu\text{A}</math>
- Optimized for a 50  $\Omega$  System
- Low Profile Surface Mount Package: 1.56mm max
- CDMA 1XRTT Compliant
- CDMA 1xEV-DO Compliant

**APPLICATIONS**

- Korean Band PCS CDMA Wireless Handsets

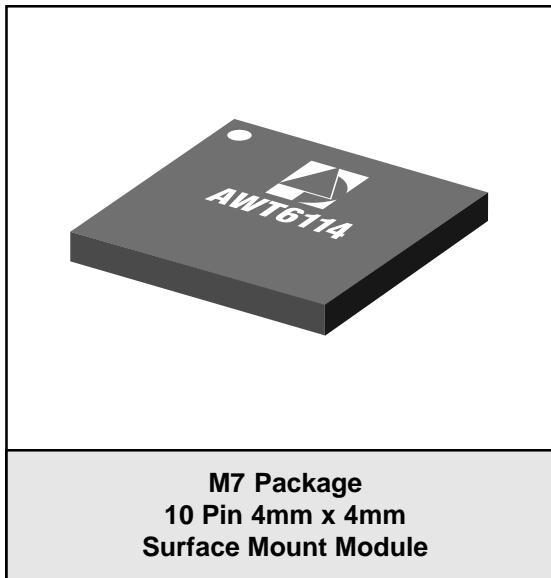

**PRODUCT DESCRIPTION**

The AWT6114 is a high power, high efficiency amplifier module for KPCS/CDMA wireless handset applications. The device is manufactured on an advanced InGaP HBT MMIC technology offering state-of-the-art reliability, temperature stability, and ruggedness. Full output power is achieved in low bias mode, reducing power drain on the system battery. No switching is required

between high and low output power levels. The amplifier module also features a shutdown mode with low leakage current, to further increase handset talk and standby time. The self-contained 4mm x 4mm surface mount package incorporates matching networks optimized for output power, efficiency and linearity in a 50  $\Omega$  system.

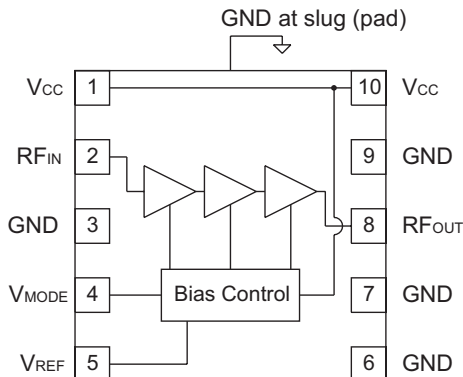

**Figure 1: Block Diagram**

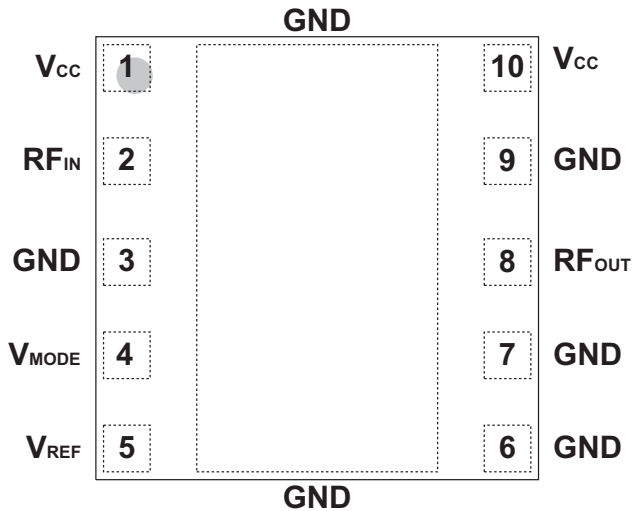

Figure 2: Pinout (X-ray Top View)

Table 1: Pin Description

PIN	NAME	DESCRIPTION
1	$V_{CC}$	Supply Voltage
2	$RF_{IN}$	RF Input
3	GND	Ground
4	$V_{MODE}$	Mode Control Voltage
5	$V_{REF}$	Reference Voltage
6	GND	Ground
7	GND	Ground
8	$RF_{OUT}$	RF Output
9	GND	Ground
10	$V_{CC}$	Supply Voltage

## ELECTRICAL CHARACTERISTICS

Table 2: Absolute Minimum and Maximum Ratings

PARAMETER	MIN	MAX	UNIT
Supply Voltage ( $V_{CC}$ )	0	+5	V
Mode Control Voltage ( $V_{MODE}$ )	0	+3.5	V
Reference Voltage ( $V_{REF}$ )	0	+3.5	V
RF Input Power ( $P_{IN}$ )	-	+10	dBm
Storage Temperature ( $T_{STG}$ )	-40	+150	°C

Stresses in excess of the absolute ratings may cause permanent damage. Functional operation is not implied under these conditions. Exposure to absolute ratings for extended periods of time may adversely affect reliability.

Table 3: Operating Ranges

PARAMETER	MIN	TYP	MAX	UNIT	COMMENTS
Operating Frequency (f)	1750	-	1780	MHz	
Supply Voltage ( $V_{CC}$ )	+3.2	+3.4	+4.2	V	
Reference Voltage ( $V_{REF}$ )	+2.75 0	+2.85 -	+3.1 +0.5	V	PA "on" PA "shut down"
Mode Control Voltage ( $V_{MODE}$ )	+2.5 0	+2.85 -	+3.1 +0.5	V	Low Bias Mode High Bias Mode
RF Output Power ( $P_{OUT}$ )	+28.0	-	-	dBm	
Case Temperature ( $T_C$ )	-30	-	+85	°C	

The device may be operated safely over these conditions; however, parametric performance is guaranteed only over the conditions defined in the electrical specifications.

**Table 4: Electrical Specifications**  
**(T<sub>C</sub> = +25 °C, V<sub>CC</sub> = +3.4 V, V<sub>REF</sub> = +2.85 V, V<sub>MODE</sub> = +2.85 V, 50 Ω system)**

PARAMETER	MIN	TYP	MAX	UNIT	COMMENTS
Gain	27 25	29 27	31 29	dB	P <sub>OUT</sub> = +28 dBm P <sub>OUT</sub> = +16 dBm
Adjacent Channel Power <sup>(1)</sup> at ±1.25 MHz offset Primary Channel BW = 1.23 MHz Adjacent Channel BW = 30 kHz	- -	-50 -51	-47 -47	dB	P <sub>OUT</sub> = +28 dBm P <sub>OUT</sub> = +16 dBm
Adjacent Channel Power at ±2.25 MHz offset Adjacent Channel BW = 30 kHz Primary Channel BW = 1.23 MHz	- -	-57 -67	-56 -57	dB	P <sub>OUT</sub> = +28dBm P <sub>OUT</sub> = +16 dBm
Power-Added Efficiency <sup>(1)</sup>	35.5 7.0	36.5 7.5	- -	%	P <sub>OUT</sub> = +28 dBm P <sub>OUT</sub> = +16 dBm
Quiescent Current (I <sub>q</sub> )	-	61	-	mA	
Reference Current	-	6.5	9	mA	through V <sub>REF</sub> pin
Mode Control Current	-	0.3	0.5	mA	through V <sub>MODE</sub> pin
Leakage Current	-	<1	5	μA	V <sub>CC</sub> = +4.2 V, V <sub>REF</sub> = 0 V V <sub>MODE</sub> = 0 V
Noise in Receive Band	-	-136	-133	dBm/Hz	1840 MHz to 1870 MHz
Harmonics 2fo 3fo, 4fo	- -	-48 -55	-30 -30	dBc	
Input Impedance	-	-	2:1	VSWR	
Spurious Output Level (all spurious outputs)	-	-	-60	dBc	P <sub>OUT</sub> ≤ +28 dBm In-band load VSWR < 8:1 Out-of-band load VSWR < 8:1 Applies over all voltage and temperature operating ranges
Load mismatch stress with no permanent degradation or failure	8:1	-	-	VSWR	V <sub>CC</sub> = +5.0 V, P <sub>IN</sub> = +5 dBm Applies over full operating temperature range

Notes:

(1) PAE and ACP limit applies to 1765 MHz.

PERFORMANCE DATA

**Figure 3: Large Signal Gain vs. Frequency**  
 $P_{OUT} = +28 \text{ dBm}$ ,  $V_{CC} = +3.4 \text{ V}$ ,  $V_{REF} = +2.85 \text{ V}$ ,  
 $V_{MODE} = +2.85 \text{ V}$  (Low Bias)

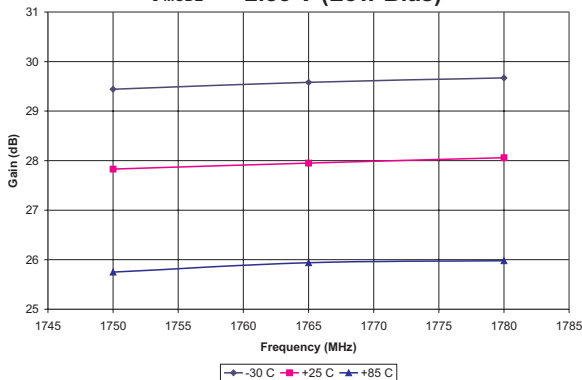

**Figure 4: High Power PAE vs. Frequency**  
 $P_{OUT} = +28 \text{ dBm}$ ,  $V_{CC} = +3.4 \text{ V}$ ,  $V_{REF} = +2.85 \text{ V}$ ,  
 $V_{MODE} = +2.85 \text{ V}$  (Low Bias)

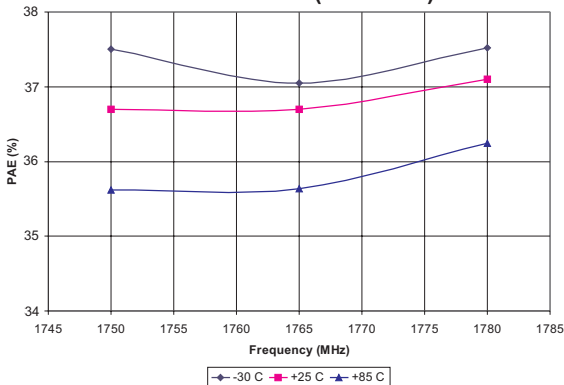

**Figure 5: High Power ACPR vs. Frequency**  
 $P_{OUT} = +28 \text{ dBm}$ ,  $V_{CC} = +3.4 \text{ V}$ ,  $V_{REF} = +2.85 \text{ V}$ ,  
 $V_{MODE} = +2.85 \text{ V}$  (Low Bias)

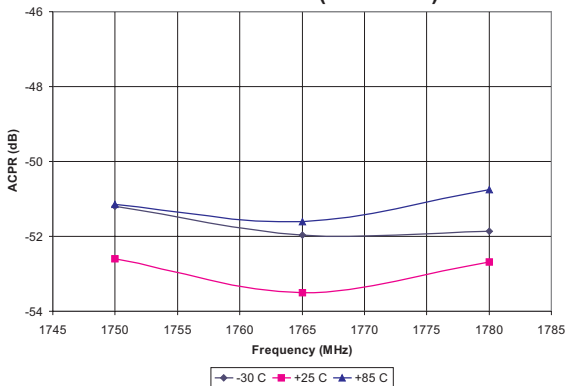

**Figure 6: High Power ACPR2 vs. Frequency**  
 $P_{OUT} = +28 \text{ dBm}$ ,  $V_{CC} = +3.4 \text{ V}$ ,  $V_{REF} = +2.85 \text{ V}$ ,  
 $V_{MODE} = +2.85 \text{ V}$  (Low Bias)

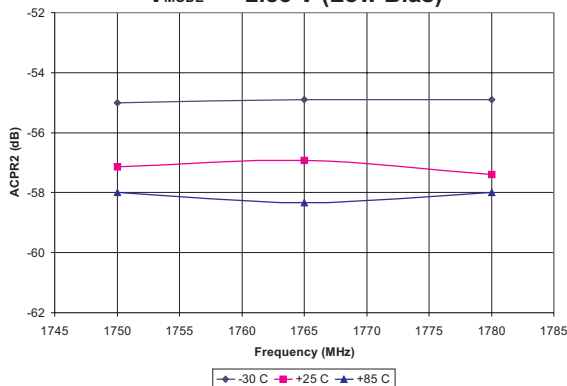

**Figure 7: Small Signal Gain vs. Frequency**  
 $P_{OUT} = +16 \text{ dBm}$ ,  $V_{CC} = +3.4 \text{ V}$ ,  $V_{REF} = +2.85 \text{ V}$ ,  
 $V_{MODE} = +2.85 \text{ V}$  (Low Bias)

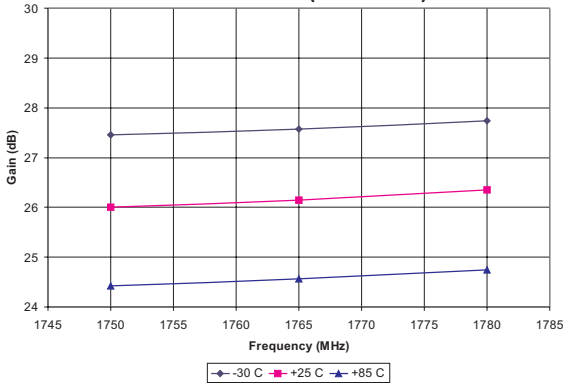

**Figure 8: Low Power PAE vs. Frequency**  
 $P_{OUT} = +16 \text{ dBm}$ ,  $V_{CC} = +3.4 \text{ V}$ ,  $V_{REF} = +2.85 \text{ V}$ ,  
 $V_{MODE} = +2.85 \text{ V}$  (Low Bias)

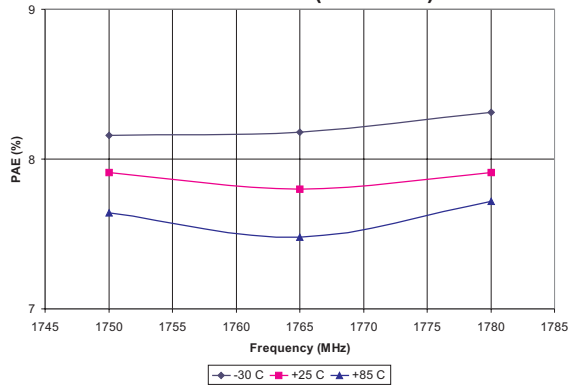

**Figure 9: Low Power ACPR vs. Frequency**  
 $P_{OUT} = +16 \text{ dBm}$ ,  $V_{CC} = +3.4 \text{ V}$ ,  $V_{REF} = +2.85 \text{ V}$ ,  
 $V_{MODE} = +2.85 \text{ V}$  (Low Bias)

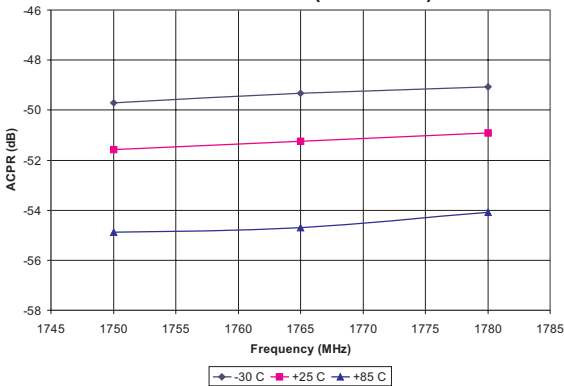

**Figure 10: Low Power ACPR2 vs. Frequency**  
 $P_{OUT} = +16 \text{ dBm}$ ,  $V_{CC} = +3.4 \text{ V}$ ,  $V_{REF} = +2.85 \text{ V}$ ,  
 $V_{MODE} = +2.85 \text{ V}$  (Low Bias)

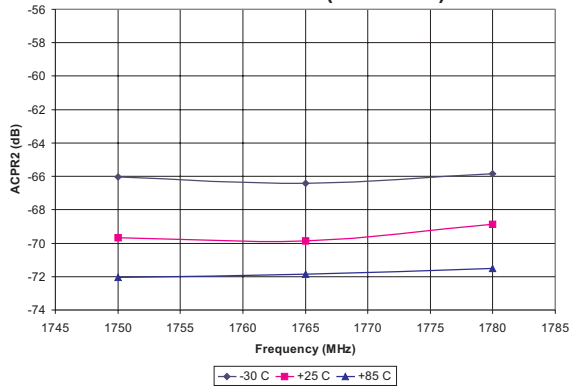

## APPLICATION INFORMATION

To ensure proper performance, refer to all related Application Notes on the ANADIGICS web site: <http://www.anadigics.com>

### Shutdown Mode

The power amplifier may be placed in a shutdown mode by applying logic low levels (see Operating Ranges table) to both the  $V_{REF}$  and  $V_{MODE}$  voltages.

### Bias Modes

The power amplifier may be placed in either a Low Bias mode or a High Bias mode by applying the appropriate logic level (see Operating Ranges table) to the  $V_{MODE}$  voltage. The Bias Control table lists the recommended modes of operation for various applications.

**Table 5: Bias Control**

APPLICATION	$P_{OUT}$ LEVELS	BIAS MODE	$V_{REF}$	$V_{MODE}$
CDMA - low power	$\leq +28$ dBm	Low	+2.85 V	+2.85 V
CDMA - high power	$> +16$ dBm	High	+2.85 V	0 V
Shutdown	-	Shutdown	0 V	0 V

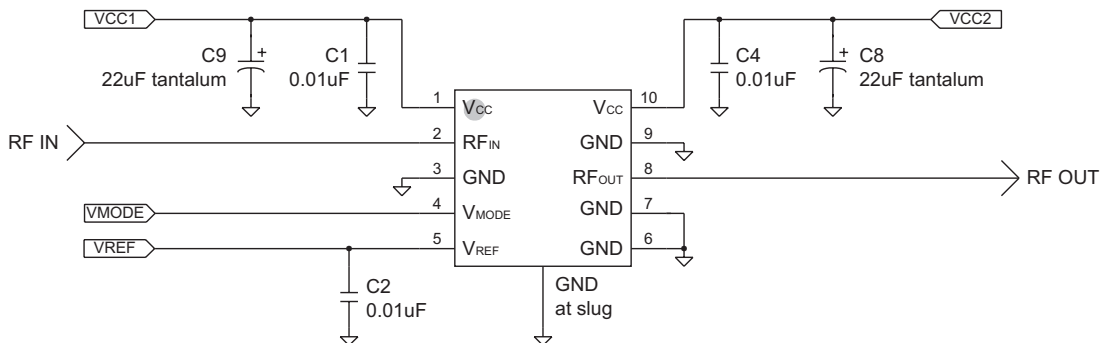

**Figure 11: Application Circuit Schematic**

PACKAGE OUTLINE

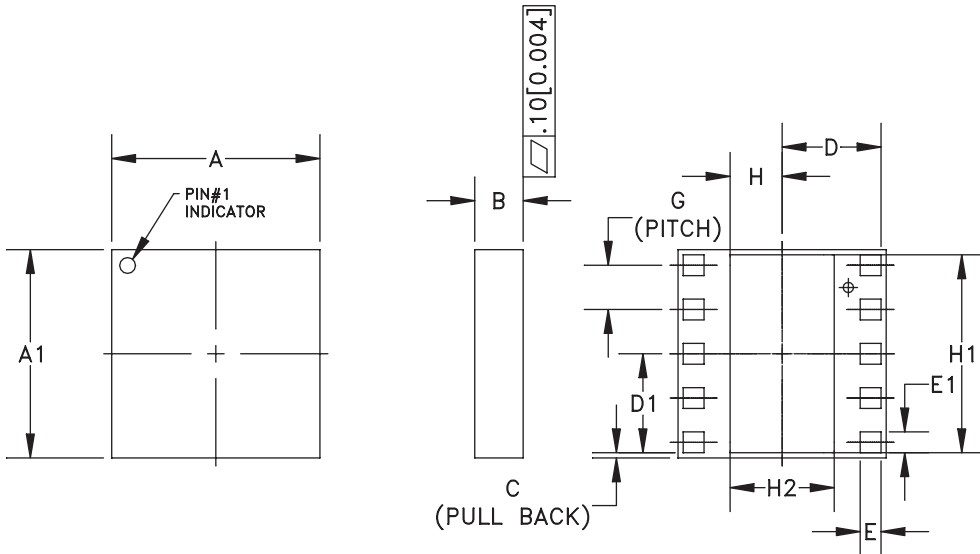

SYMBOL	MILLIMETERS			INCHES			NOTE
	MIN.	NOM.	MAX.	MIN.	NOM.	MAX.	
A	3.88	4.00	4.12	0.152	0.157	0.162	-
A1	3.88	4.00	4.12	0.152	0.157	0.162	-
B	1.26	1.41	1.56	0.049	0.055	0.061	-
C	-	0.10	-	-	0.004	-	-
D	-	1.90	-	-	0.075	-	-
D1	-	1.90	-	-	0.075	-	-
E	0.35	0.40	0.45	0.013	0.015	0.017	-
E1	0.35	0.40	0.45	0.013	0.015	0.017	-
G	0.85 BSC			0.033 BSC			-
H	-	1.00	-	-	0.039	-	-
H1	-	3.80	-	-	0.149	-	-
H2	-	2.00	-	-	0.078	-	-

- NOTES:
1. CONTROLLING DIMENSIONS: MILLIMETERS
  2. UNLESS SPECIFIED TOLERANCE=±0.076[0.003].

Figure 12: M7 Package Outline - 10 Pin 4mm x 4mm Surface Mount Module

TOP BRAND

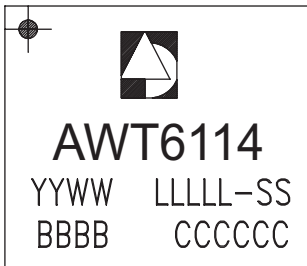

NOTES:

1. ANADIGICS LOGO SIZE: X=0.040±0.010 Y=0.048±0.010
2. PART # AWT6114
3. YEAR AND WORK WEEK: YYWW: YY = YEAR, WW = WORK WEEK
4. LOT - WAFER I.D.: LLLLL = LOT#, SS = WAFER I.D.
5. PIN 1 INDICATOR: MOLD NOTCH -or- INK DOT
6. BOM # BBBB
7. COUNTRY CODE: CCCCC
8. TYPE : ELITE  
SIZE : AS LARGE AS POSSIBLE  
WHITE or SILVER

Figure 13: Branding Specification



COMPONENT PACKAGING

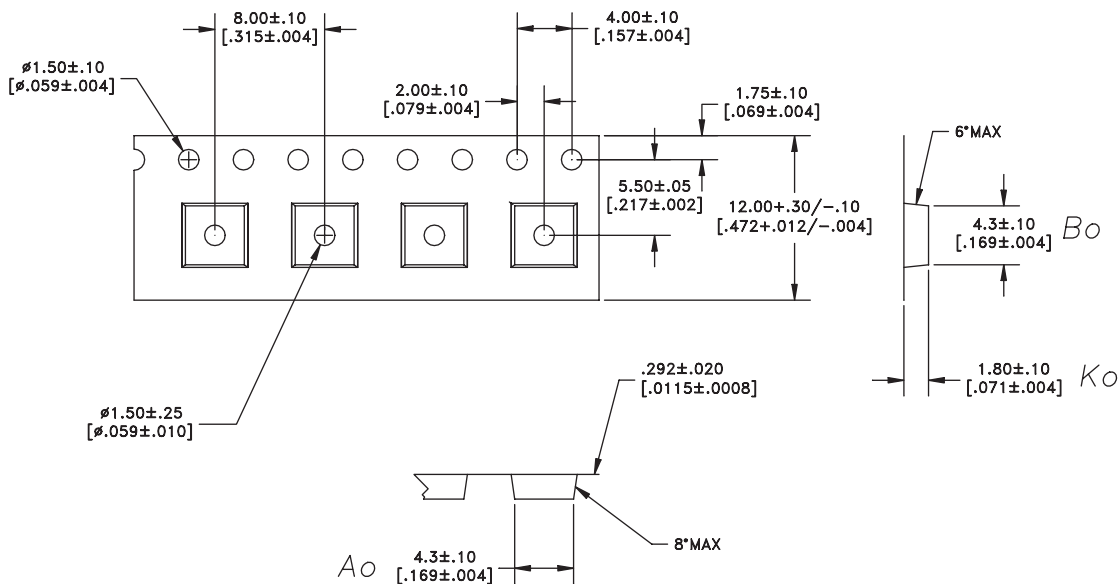

DIMENSIONS ARE IN MILLIMETERS [INCHES]  
STANDARD TOLERANCES

Figure 14: Tape & Reel Packaging

Table 6: Tape & Reel Dimensions

PACKAGE TYPE	TAPE WIDTH	POCKET PITCH	REEL CAPACITY	MAX REEL DIA
4mm X 4mm	12mm	8mm	2500	13"

**AWT6114**

**NOTES**

NOTES

**ORDERING INFORMATION**

ORDER NUMBER	TEMPERATURE RANGE	PACKAGE DESCRIPTION	COMPONENT PACKAGING
AWT6114M7P8	-30 °C to +110 °C	10 Pin 4mm x 4mm Surface Mount Module	Tape and Reel, 2500 pieces per Reel

**ANADIGICS, Inc.**

141 Mount Bethel Road  
Warren, New Jersey 07059, U.S.A.

Tel: +1 (908) 668-5000

Fax: +1 (908) 668-5132

URL: <http://www.anadigics.com>

E-mail: [Mktg@anadigics.com](mailto:Mktg@anadigics.com)

**IMPORTANT NOTICE**

ANADIGICS, Inc. reserves the right to make changes to its products or to discontinue any product at any time without notice. The product specifications contained in Advanced Product Information sheets and Preliminary Data Sheets are subject to change prior to a product's formal introduction. Information in Data Sheets have been carefully checked and are assumed to be reliable; however, ANADIGICS assumes no responsibilities for inaccuracies. ANADIGICS strongly urges customers to verify that the information they are using is current before placing orders.

**WARNING**

ANADIGICS products are not intended for use in life support appliances, devices or systems. Use of an ANADIGICS product in any such application without written consent is prohibited.