

### Features

- Stable at Gains of 2 or Greater
- Gain Bandwidth.....70MHz
- High Slew Rate (Min.) .....300V/ $\mu$ s
- High Output Current (Min.) .....100mA
- Power Bandwidth (Typ.) .....5.5MHz
- Output Voltage Swing (Min.) ..... $\pm 10V$
- Monolithic Bipolar Dielectric Isolation Construction

### Description

The HA-2542 is a wideband, high slew rate, monolithic operational amplifier featuring an outstanding combination of speed, bandwidth, and output drive capability.

Utilizing the advantages of the Harris D. I. technology this amplifier offers 350V/ $\mu$ s slew rate, 70MHz gain bandwidth, and  $\pm 100mA$  output current. Application of this device is further enhanced through stable operation down to closed loop gains of 2.

For additional flexibility, offset null and frequency compensation controls are included in the HA-2542 pinout.

The capabilities of the HA-2542 are ideally suited for high speed coaxial cable driver circuits where low gain and high output drive requirements are necessary. With 5.5MHz full power bandwidth, this amplifier is most

### Applications

- Pulse and Video Amplifiers
- Wideband Amplifiers
- Coaxial Cable Drivers
- Fast Sample-Hold Circuits
- High Frequency Signal Conditioning Circuits

suitable for high frequency signal conditioning circuits and pulse video amplifiers. Other applications utilizing the HA-2542 advantages include wideband amplifiers and fast sample-hold circuits.

The HA-2542 is available in ceramic or plastic 14 lead DIP packages, or a 12 lead metal can (TO-8) which is pin compatible with the HA-2541, HA-5190, LH0032 and HOS-050C. The HA-2542-2 is specified over the  $-55^{\circ}C$  to  $+125^{\circ}C$  temperature range and is also offered as a military part. The HA-2542-5 is specified over the commercial temperature range of  $0^{\circ}C$  to  $75^{\circ}C$ .

For more information on the HA-2542, please refer to Application Note 552 (Using The HA-2542), or Application Note 556 (Thermal Safe-Operating-Areas For High Current Op Amps).

### Pinouts

HA1-2542 (CERAMIC DIP)  
HA3-2542 (PLASTIC DIP)  
TOP VIEW

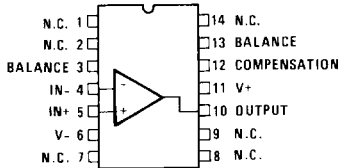

HA2-2542 (TO-8 METAL CAN)  
TOP VIEW

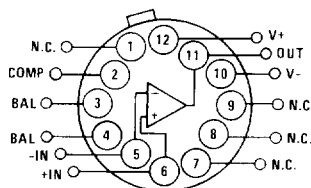

$V_{CASE} = V-$

### Schematic

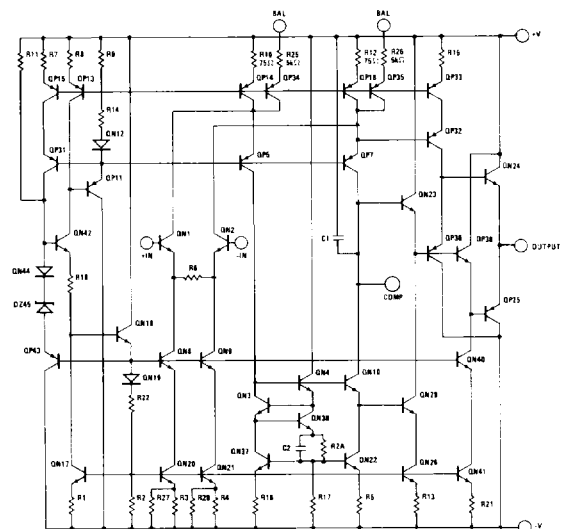

## Specifications HA-2542

### Absolute Maximum Ratings (Note 1)

Voltage between V+ and V- Terminals .....	35V
Differential Input Voltage .....	±6V
Output Current .....	125mA (Peak)
	107mA rms (Continuous)

### Operating Temperature Range:

HA-2542-2 .....	-55°C ≤ T <sub>A</sub> ≤ +125°C
HA-2542-5 .....	0°C ≤ T <sub>A</sub> ≤ +75°C
Storage Temperature Range .....	-65°C ≤ T <sub>A</sub> ≤ +150°C
Maximum Junction Temperature (Note 11) .....	+175°C

### Electrical Specifications V<sub>SUPPLY</sub> = ±15 Volts; R<sub>L</sub> = 1kΩ, C<sub>L</sub> ≤ 10pF, Unless Otherwise Specified.

PARAMETER	TEMP	HA-2542-2 -55°C to +125°C			HA-2542-5 0°C to +75°C			UNITS
		MIN	TYP	MAX	MIN	TYP	MAX	
<b>INPUT CHARACTERISTICS</b>								
Offset Voltage	+25°C		5	10		5	10	mV
	Full		8	20		8	20	mV
Average Offset Voltage Drift	Full		14			14		μV/°C
Bias Current	+25°C		15	35		15	35	μA
	Full		26	50		26	50	μA
Average Bias Current Drift	Full		66			45		nA/°C
Offset Current	+25°C		1	7		1	7	μA
	Full			9			9	μA
Input Resistance	+25°C		100			100		kΩ
Input Capacitance	+25°C		1			1		pF
Common Mode Range	Full	±10			±10			V
Input Noise Voltage (0.1Hz to 100Hz)	+25°C		2.2			2.2		μV <sub>p-p</sub>
Input Noise Voltage Density (fo = 1kHz, R <sub>G</sub> = 0Ω)	+25°C		10			10		nV/√Hz
Input Noise Current Density (fo = 1kHz, R <sub>G</sub> = 0Ω)	+25°C		3			3		pA/√Hz
<b>TRANSFER CHARACTERISTICS</b>								
Large Signal Voltage Gain (Note 3)	+25°C	10k	30k		10k	30k		V/V
	Full	5k	15k		5k	20k		V/V
Common-Mode Rejection Ratio (Note 4)	Full	70	100		70	100		dB
Minimum Stable Gain	+25°C	2			2			V/V
Gain-Bandwidth-Product (Note 5)	+25°C		70			70		MHz
<b>OUTPUT CHARACTERISTICS</b>								
Output Voltage Swing (Note 3)	Full	±10	±11		±10	±11		V
Output Current (Note 6)	+25°C	100			100			mA
Output Resistance	+25°C		5			5		Ω
Full Power Bandwidth (Note 3 & 7)	+25°C	4.7	5.5		4.7	5.5		MHz
Differential Gain (Note 2)	+25°C		0.1			0.1		%
Differential Phase (Note 2)	+25°C		0.2			0.2		Degrees
Harmonic Distortion (Note 10)	+25°C		<0.04			<0.04		%
<b>TRANSIENT RESPONSE (Note 8)</b>								
Rise Time	+25°C		4			4		ns
Overshoot	+25°C		25			25		%
Slew Rate	+25°C	300	350		300	350		V/μs
Settling Time:								
10V Step to 0.1%	+25°C		100			100		ns
10V Step to 0.01%	+25°C		200			200		ns
<b>POWER REQUIREMENTS</b>								
Supply Current	+25°C		30			30		mA
	Full		31	34.5		31	40	mA
Power Supply Rejection Ratio (Note 9)	Full	70	79		70	79		dB

NOTES:

1. Absolute maximum ratings are limiting values, applied individually, beyond which the serviceability of the circuit may be impaired. Functional operability under any of these conditions is not necessarily implied.
2. Differential gain and phase are measured at 5MHz with a 1 Volt differential input voltage.
3.  $R_L = 1k\Omega$ ,  $V_O = \pm 10V$
4.  $V_{CM} = \pm 10V$
5.  $A_{VCL} = 100$
6.  $R_L = 50\Omega$ ,  $V_O = \pm 5V$
7. Full Power Bandwidth guaranteed based on slew rate measurement using  $FPBW = \frac{\text{Slew Rate}}{2\pi V_{PEAK}}$
8. Refer to Test Circuits section of this data sheet.
9.  $V_{SUPPLY} = \pm 5VDC$  to  $\pm 15VDC$
10.  $V_{IN} = 1V_{RMS}$ ;  $f = 10kHz$ ;  $A_V = 10$ .
11. This value assumes a no load condition: Maximum power dissipation with load conditions must be designed to maintain the maximum junction temperature below  $+175^\circ C$ . By using Application Note 556 on Safe Operating Area equations, along with the packaging thermal resistances listed in the Die Characteristics section, proper load conditions can be determined. Heat sinking is recommended above  $+75^\circ C$  with suggested models:
  - 14 Lead Ceramic DIP: Thermalloy #6007 or AAVID #5602B ( $\theta_{sa} = 16^\circ C/W$ ).
  - 12 Lead Metal Can (TO-8): Thermalloy #2240A ( $\theta_{sa} = 27^\circ C/W$ ) or #2268B ( $\theta_{sa} = 24^\circ C/W$ )

Test Circuits

TEST CIRCUIT

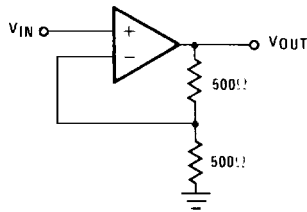

$V_S = \pm 15V$   
 $A_V = +2$   
 $C_L \leq 10pF$

LARGE SIGNAL RESPONSE

Vertical Scale (Volts:  $V_{IN} = 2.0V/Div.$ ,  
 $V_{OUT} = 5.0V/Div.$ )  
 Horizontal Scale (Time: 200ns/Div.)

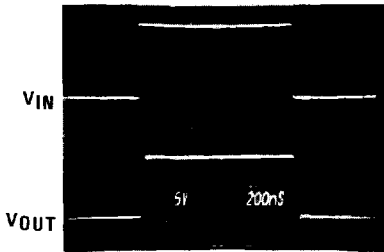

SMALL SIGNAL RESPONSE

Vertical Scale (Volts: 100mV/Div.)  
 Horizontal Scale (Time: 50ns/Div.)

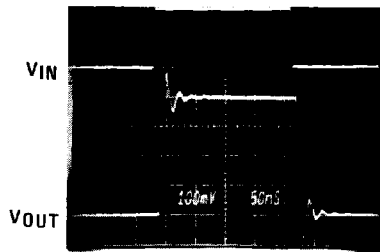

TIME DELAY

Vertical Scale (Volts: 100mV/Div.)  
 Horizontal Scale (Time: 10ns/Div.)

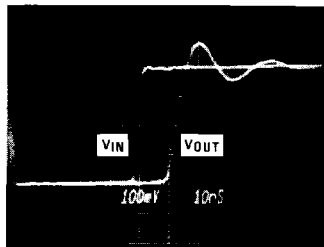

$V_S = \pm 15V$ ,  $R_L = 1k\Omega$   
 $T = +25^\circ C$   
 Propagation delay variance is negligible over full temperature range.

**Test Circuits (Continued)**

**SETTLING TIME TEST CIRCUIT**

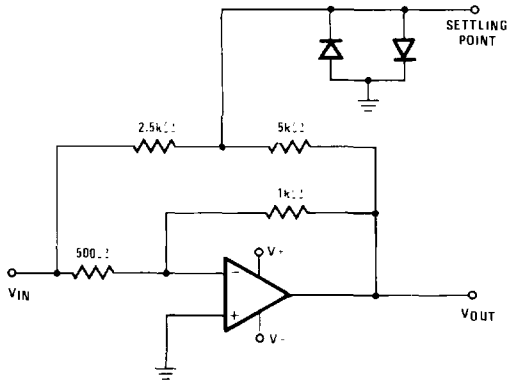

- $A_V = -2$
- Feedback and summing resistors must be matched (0.1%)
- HP5082-2810 clipping diodes recommended
- Tektronix P6201 FET probe used at settling point
- For 0.01% settling time, heat sinking is suggested to reduce thermal effects and an analog ground plane with supply decoupling is suggested to minimize ground loop errors

**SUGGESTED OFFSET VOLTAGE ADJUSTMENT**

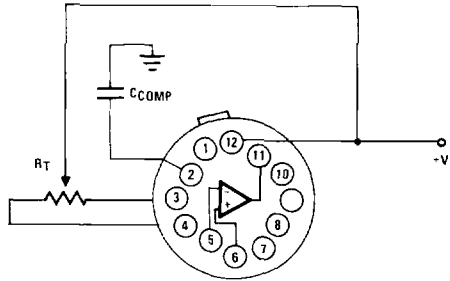

Suggested compensation scheme 5-20pF

Tested Offset Adjustment Range is  $|V_{OS} + 1mV|$  minimum referred to output. Typical range is +20mV with  $R_T = 5k\Omega$ .

**Typical Performance Curves**

**INPUT NOISE VOLTAGE AND INPUT NOISE CURRENT vs. FREQUENCY**

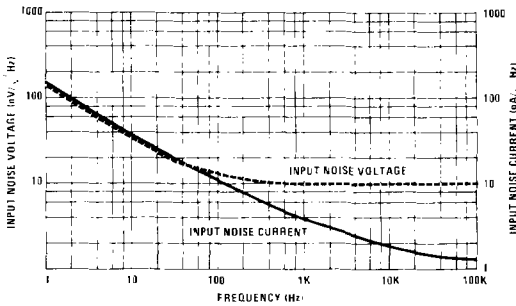

**OFFSET VOLTAGE DRIFT WITH TEMPERATURE**  
Of Six Representative Units,  $V_S = +, -12V$

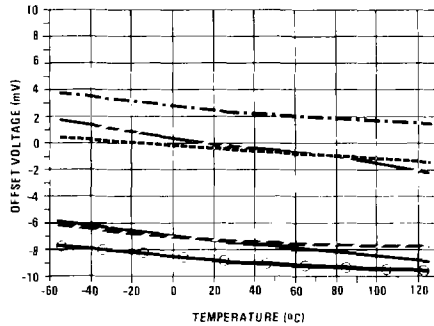

**INPUT RESISTANCE vs. FREQUENCY**

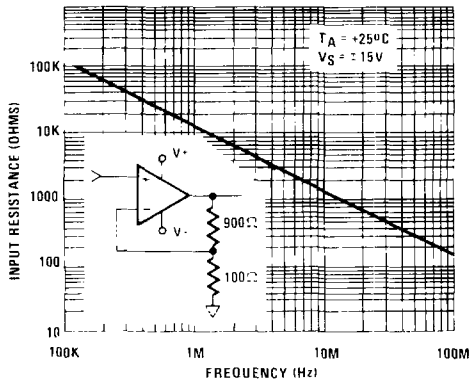

**BIAS CURRENT DRIFT WITH TEMPERATURE**  
Of Six Representative Units,  $V_S = +, -12V$

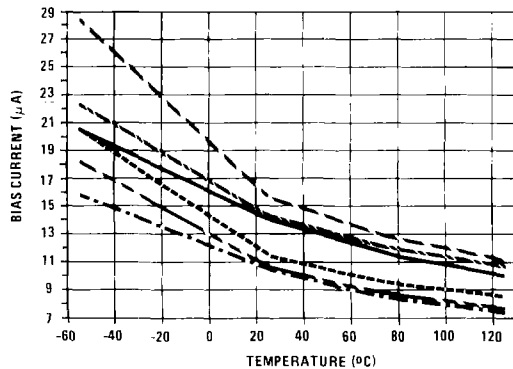

**Typical Performance Curves (Continued)**

**BIAS CURRENT vs. POWER SUPPLY**  
Six Units At Various Supplies At +25°C

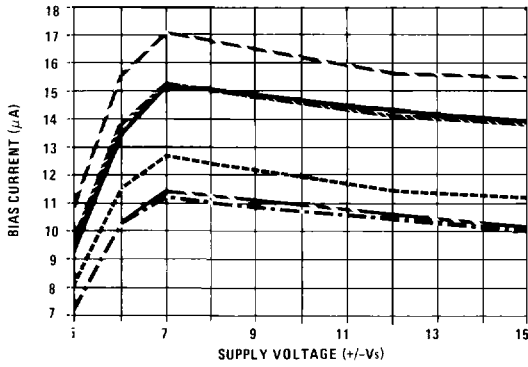

**PSRR AND CMRR vs. TEMPERATURE**  
 $V_S = \pm 15V$

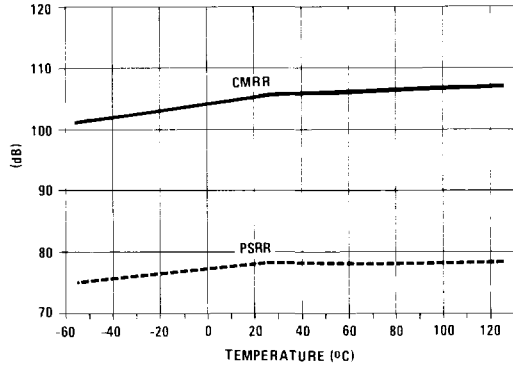

**SUPPLY CURRENT vs. SUPPLY VOLTAGE**  
At Various Temperatures

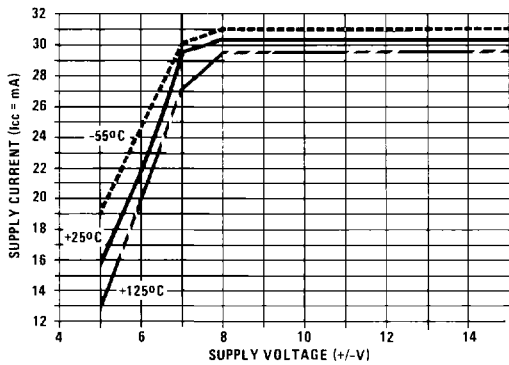

**PSRR AND CMRR vs. FREQUENCY**

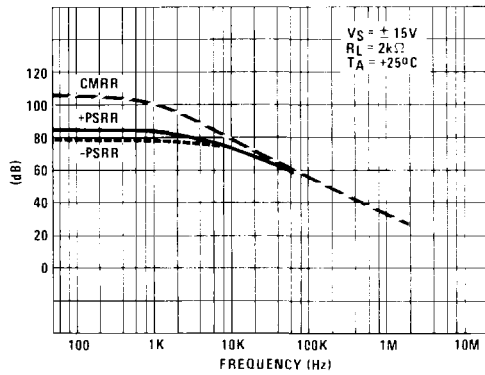

**SLEW RATE vs. TEMPERATURE**

At Various Supply Voltages With  $R_{Load} = 100\Omega$

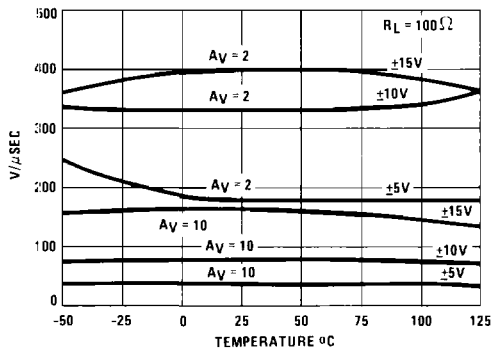

**OPEN LOOP GAIN vs. TEMPERATURE**

At Various Supply Voltages

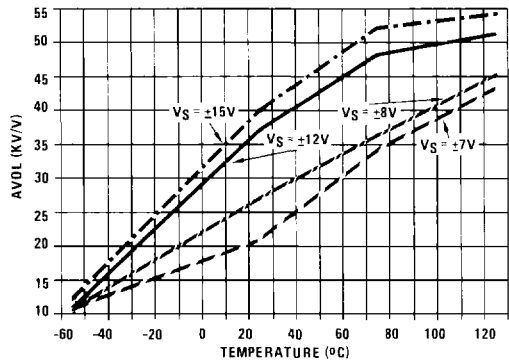

Typical Performance Curves (Continued)

OUTPUT VOLTAGE SWING vs. SUPPLY VOLTAGE  
At Various Temperatures

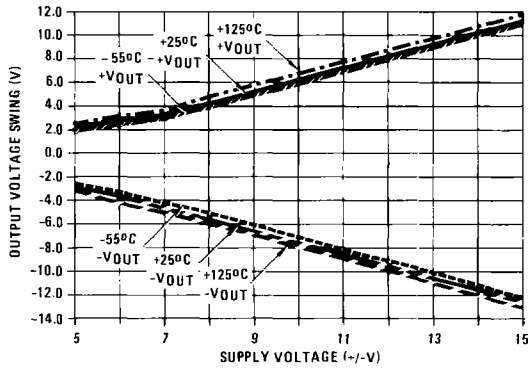

NORMALIZED AC PARAMETERS vs.  
COMPENSATION CAPACITANCE

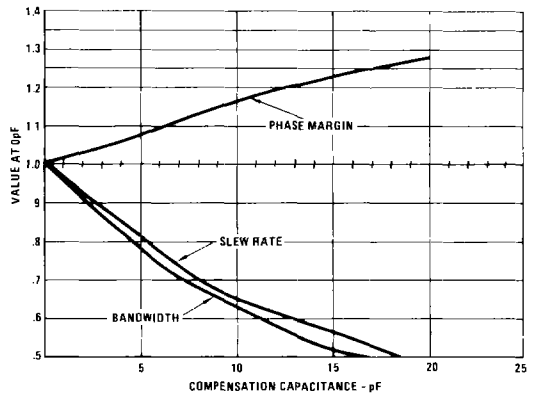

OUTPUT VOLTAGE SWING vs. FREQUENCY  
 $V_S = \pm 15V$

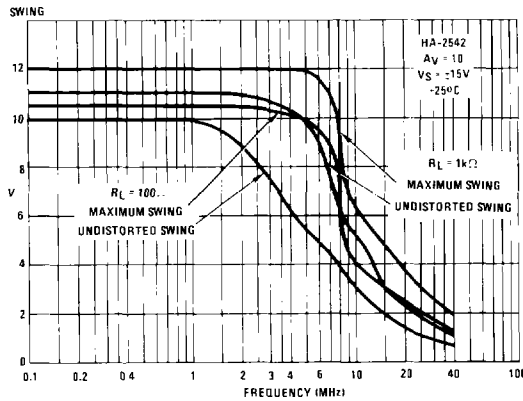

OUTPUT VOLTAGE SWING vs. FREQUENCY  
 $V_S = \pm 10V$

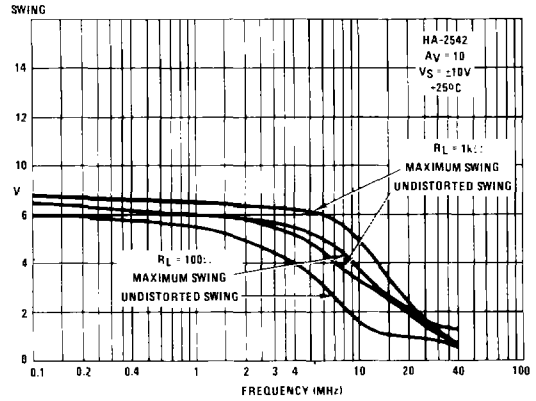

FREQUENCY RESPONSE CURVES

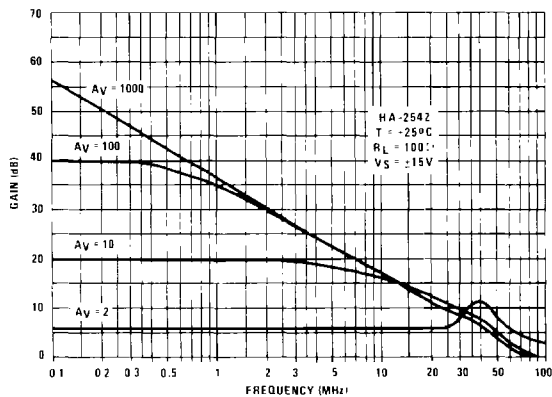

HA-2542 CLOSED LOOP GAIN vs. TEMPERATURE

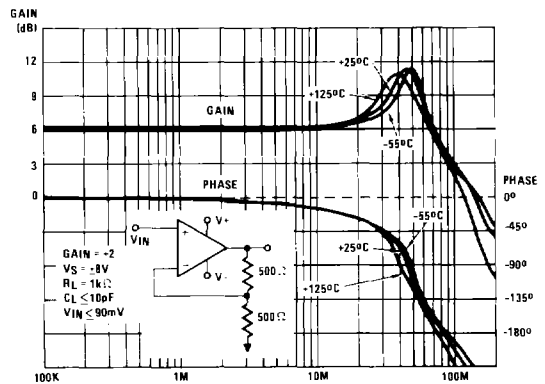

## Die Characteristics

Transistor Count .....	43	
Die Dimensions .....	72 x 105 x 19 mils (1820 $\mu$ m x 2670 $\mu$ m x 485 $\mu$ m)	
Substrate Potential* .....	V-	
Process .....	High Frequency Bipolar-DI	
Passivation .....	Nitride	
Thermal Constants (°C/W)	$\theta_{ja}$	$\theta_{jc}$
HA1-2542 Ceramic DIP	86.6	32.5
HA3-2542 Plastic DIP	78.8	30.6
HA2-2542 Metal Can	58	29

\*The substrate may be left floating (Insulating Die Mount) or it may be mounted on a conductor at V- potential.

## Typical Applications (Refer to Application Note 552 for Further Information)

The Harris HA-2542 is a state of the art monolithic device which also approaches the "ALL-IN-ONE" amplifier concept. This device features an outstanding set of AC parameters augmented by excellent output drive capability providing for suitable application in both high speed and high output drive circuits.

Primarily intended to be used in balanced 50 $\Omega$  and 75 $\Omega$

coaxial cable systems as a driver, the HA-2542 could also be used as a power booster in audio systems as well as a power amp in power supply circuits. This device would also be suitable as a small DC motor driver.

The applications shown on the following page demonstrate the HA-2542 at gains of +100 and +2 and as a video cable driver for small signals.

## Prototyping Guidelines

For best overall performance in any application, it is recommended that high frequency layout techniques be used. This should include: 1) mounting the device through a ground plane; 2) connecting unused pins (N.C.) to the ground plane; 3) mounting feedback components on Teflon standoffs and/or locating these components as

close to the device as possible; 4) placing power supply decoupling capacitors from device supply pins to ground.

As a result of speed and bandwidth optimization, the HA-2542 can's case potential, when powered-up, is equal to the V- potential. Therefore, contact with other circuitry or ground should be avoided.

## Frequency Compensation

The HA-2542 may be externally compensated with a single capacitor to ground. This provides the user the additional flexibility in tailoring the frequency response of the amplifier. A guideline to the response is demonstrated on the typical performance curve showing the normalized A.C. parameters versus compensation capacitance. It is suggested that the user check and tailor the accurate compensation value for each application. As shown additional phase margin is achieved at the loss of slew rate and bandwidth.

For example, for a voltage gain of +2 (or -1) and a load of 500pF/2k $\Omega$ , 20pF is needed for compensation to give a small signal bandwidth of 30MHz with 40° of phase margin. If a full power output voltage of  $\pm 10V$  is needed, this same configuration will provide a bandwidth of 5MHz and a slew rate of 200V/ $\mu$ s.

If maximum bandwidth is desired and no compensation is needed, care must be given to minimize parasitic capacitance at the compensation pin. In some cases where minimum gain applications are desired, bending up or totally removing this pin may be the solution. In this case, care must also be given to minimize load capacitance.

For wideband positive unity gain applications, the HA-2542 can also be over-compensated with capacitance greater than 30pF to achieve bandwidths of around 25MHz. This over-compensation will also improve capacitive load handling or lower the noise bandwidth. This versatility along with the  $\pm 100mA$  output current makes the HA-2542 an excellent high speed driver for many power applications.

Typical Applications

NONINVERTING CIRCUIT ( $A_{VCL} = 100$ )

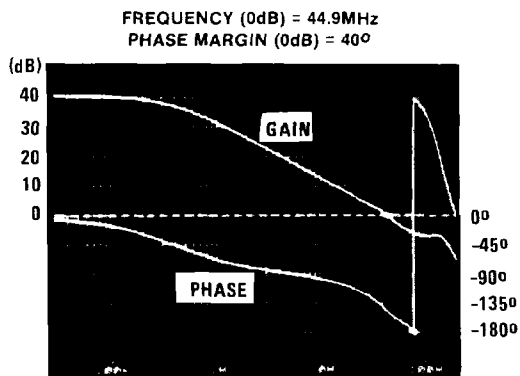
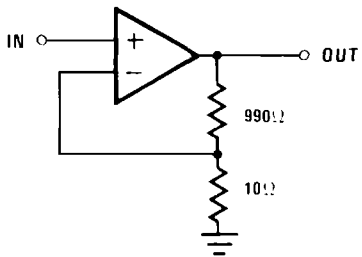

$A_{VCL} = 100$  PHASE AND GAIN

NONINVERTING CIRCUIT ( $A_{VCL} = 2$ )

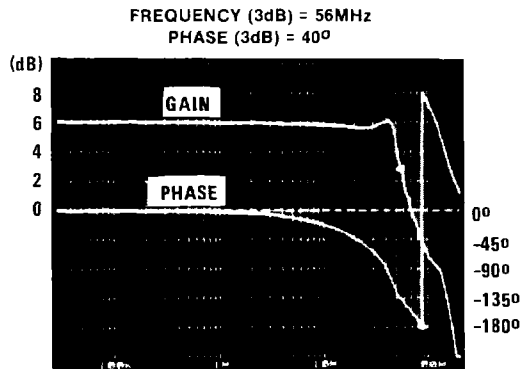
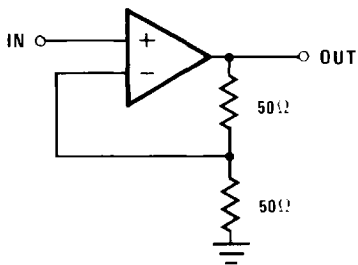

$A_{VCL} = 2$  PHASE AND GAIN

VIDEO CABLE DRIVER ( $A_{VCL} = 2$ )

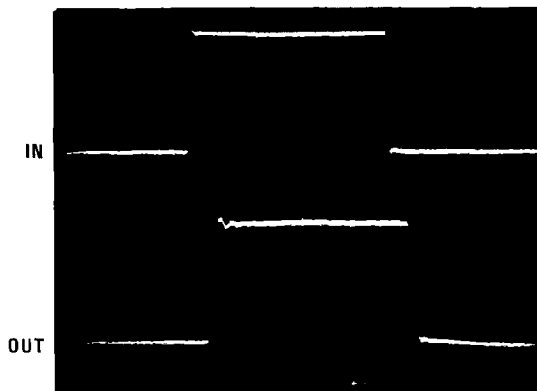
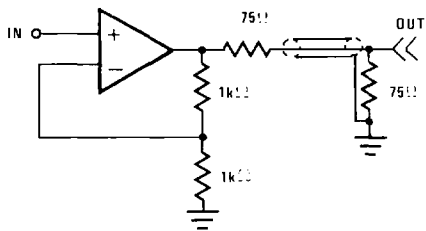

VIDEO CABLE DRIVER PULSE RESPONSE  
(1V/Div.; 100ns/Div.)