

**Precision 0.600V Low Voltage FGA™
References**

The ISL21032 FGA™ voltage references are very high precision analog voltage references specifically designed to meet the rigorous performance requirements of high current, low voltage VRM and POL modules.

Fabricated in Intersil's proprietary Floating Gate Analog technology, these references feature guaranteed performance over the -40°C to +130°C operating temperature range.

Additional features include guaranteed absolute accuracy as low as ±0.5% over the operating temperature range of -40°C to +130°C. Long-term stability is 10ppm/√1,000Hrs.

The absolute accuracy and thermal performance of the ISL21032 family are ideal fit for the next generation of high current, low voltage VRM and POL modules.

Pinout

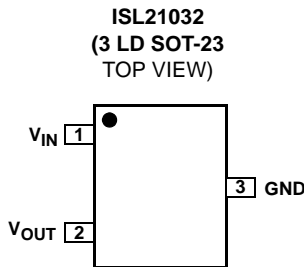

Features

- Reference Voltage 0.6V
- Initial Accuracy Options @ +25°C ±1.0mV, ±2.5mV, and ±5.0mV
- Absolute Accuracy Options Over Operating Temp Range ±0.5% (±3.0mV), ±0.75% (±4.5mV), and ±1.0% (±6.0mV)
- Supply Voltage Range 2.7V to 5.5V
- Low Quiescent Current 12µA typ.
- Long Term Stability 10ppm/√1,000Hrs.
- Thermal Hysteresis 100ppm @ ΔT_A = +170°C
- Source & Sink Current 7mA
- ESD Protection. 5kV (Human Body Model)
- Standard 3 Ld SOT-23 Packaging
- Extended Temperature Range -40°C to +130°C
- Pb-Free Plus Anneal Available (RoHS Compliant)

Applications

- Low Voltage, High Current VRM & POL Modules
- Accurate Reference for Low Voltage DC/DC Converters

Ordering Information

PART NUMBER (Note)	PART MARKING	V _{OUT} OPTION (V)	GRADE	TEMP. RANGE (°C)	PACKAGE (Pb-free)
ISL21032BPH306Z	DEU	0.6	±0.5% @ DT _A = 170°C	-40 to 130	3 Ld SOT-23
ISL21032BPH306Z-TK	DEU	0.6	±0.5% @ DT _A = 170°C	-40 to 130	3 Ld SOT-23 T&R
ISL21032CPH306Z	DEV	0.6	±0.75% @ DT _A = 170°C	-40 to 130	3 Ld SOT-23
ISL21032CPH306Z-TK	DEV	0.6	±0.75% @ DT _A = 170°C	-40 to 130	3 Ld SOT-23 T&R
ISL21032DPH306Z	APE	0.6	±1.0% @ DT _A = 170°C	-40 to 130	3 Ld SOT-23
ISL21032DPH306Z-TK	APE	0.6	±1.0% @ DT _A = 170°C	-40 to 130	3 Ld SOT-23 T&R

NOTE: Intersil Pb-free plus anneal products employ special Pb-free material sets; molding compounds/die attach materials and 100% matte tin plate termination finish, which are RoHS compliant and compatible with both SnPb and Pb-free soldering operations. Intersil Pb-free products are MSL classified at Pb-free peak reflow temperatures that meet or exceed the Pb-free requirements of IPC/JEDEC J STD-020.

Absolute Maximum Ratings

Storage Temperature Range -65°C to + 150°C
 Max Voltage V_{IN} to Gnd. -0.5V to +6.5V
 Max Voltage V_{OUT} to Gnd*:
 ISL21032, $V_{OUT} = 0.6V$ -0.5V to +1.6V
 Voltage on “DNC” Pins. . . No Connections Permitted to These Pins.

Thermal Information

Thermal Resistance θ_{JA} (°C/W)
 3 Ld SOT-23 Package 400
 Storage Temperature -65°C to +150°C
 Lead Temperature, Soldering* +225°C
 *Note: Maximum Duration = 10s

ESD Ratings

MIL-STD 883, Method 3015. 5kV
 ESD Rating (Machine Model) 500V

CAUTION: Absolute Maximum Ratings are limits which may result in impaired reliability and/or permanent damage to the device. These are stress ratings provided for information only and functional operation of the device at these or any other conditions beyond those indicated in the operational sections of this specification are not implied.

For guaranteed specifications and test conditions, see Electrical Characteristics.

The guaranteed specifications apply only for the test conditions listed. Some performance characteristics may degrade when the device is not operated under the listed test conditions.

Electrical Specifications ($V_{OUT} = 0.600V$)

Operating Conditions: $V_{IN} = 3.0V$, $I_{OUT} = 0mA$, $C_{OUT} = 0.001\mu F$, $T_A = -40$ to $+130^\circ C$, unless otherwise specified.

SYMBOL	PARAMETER	CONDITIONS	MIN	TYP	MAX	UNITS
V_{OUT}	Output Voltage			0.600		V
VOA	V_{OUT} Accuracy @ $T_A = 25^\circ C$	ISL21032B06	-1.0		+1.0	mV
		ISL21032C06	-2.5		+2.5	mV
		ISL21032D06	-5.0		+5.0	mV
VOA	V_{OUT} Accuracy Over Op Temp Range ($-40^\circ < T_A < 130^\circ C$)	ISL21032B06	-3.0		+3.0	mV
		ISL21032C06	-4.5		+4.5	mV
		ISL21032D06	-6.0		+6.0	mV
V_{IN}	Input Voltage Range		2.7		5.5	V
IIN	Supply Current			12	25	μA
$\Delta V_{OUT}/\Delta V_{IN}$	Line Regulation	$+2.7V \leq V_{IN} \leq +5.5V$		50	200	$\mu V/V$
$\Delta V_{OUT}/\Delta I_{OUT}$	Load Regulation	Sourcing: $0mA \leq I_{SOURCE} \leq 7mA$		20	70	$\mu V/mA$
		Sinking: $-7mA \leq I_{SINK} \leq 0mA$		20	70	$\mu V/mA$
$\Delta V_{OUT}/\Delta t$	Long Term Stability (Note 3)	$T_A = 25^\circ C$		10		ppm/ $\sqrt{1kHrs}$
$\Delta V_{OUT}/\Delta T_A$	Thermal Hysteresis (Note 1)	$\Delta T_A = 170^\circ C$		100		ppm
ISC	Short Circuit Current (Note 2)	$T_A = 25^\circ C$, V_{OUT} tied to Gnd		50	80	mA
VN	Output Voltage Noise	$0.1Hz \leq f \leq 10Hz$		30		$\mu Vp-p$

NOTES:

- Thermal Hysteresis is the change in V_{OUT} measured @ $T_A = 25^\circ C$ after temperature cycling over a specified range, ΔT_A . V_{OUT} is read initially at $T_A = 25^\circ C$ for the device under test. The device is temperature cycled and a second V_{OUT} measurement is taken at $25^\circ C$. The difference between the initial V_{OUT} reading and the second V_{OUT} reading is then expressed in ppm. For $\Delta T_A = 170^\circ C$, the device under is cycled from $+25^\circ C$ to $+130^\circ C$ to $-40^\circ C$ to $+25^\circ C$.
- Guaranteed by device characterization and/or correlation to other device tests.
- FGA™ voltage reference long term drift is a logarithmic characteristic. Changes that occur after the first few hundred hours of operation are significantly smaller with time, asymptotically approaching zero beyond 2000 hours. Because of this decreasing characteristic, long-term drift is specified in ppm/ $\sqrt{1kHr}$.

Typical Performance Curves, ISL21032 Low Voltage Output Reference

$V_{IN} = 3.0V$, $I_{OUT} = 0mA$, $T_A = 25^\circ C$ Unless Otherwise Specified

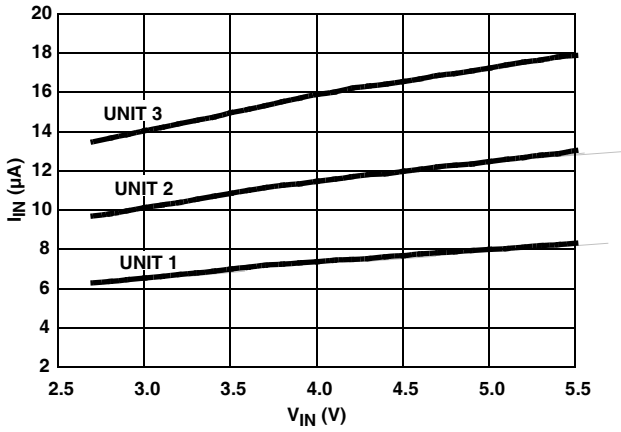

FIGURE 1. I_{IN} vs V_{IN} (3 REPRESENTATIVE UNITS)

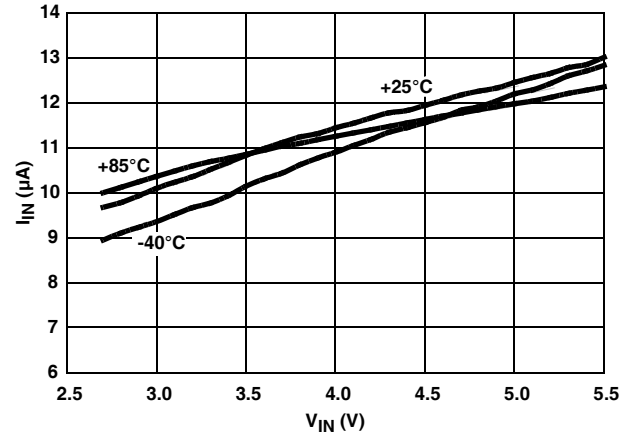

FIGURE 2. I_{IN} vs V_{IN} - 3 TEMPS

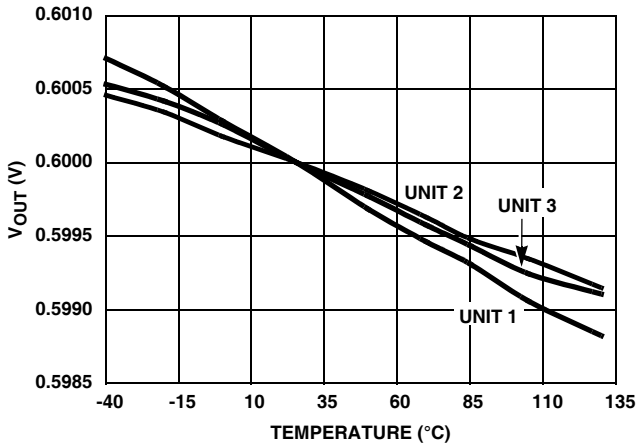

FIGURE 3. V_{OUT} vs TEMP

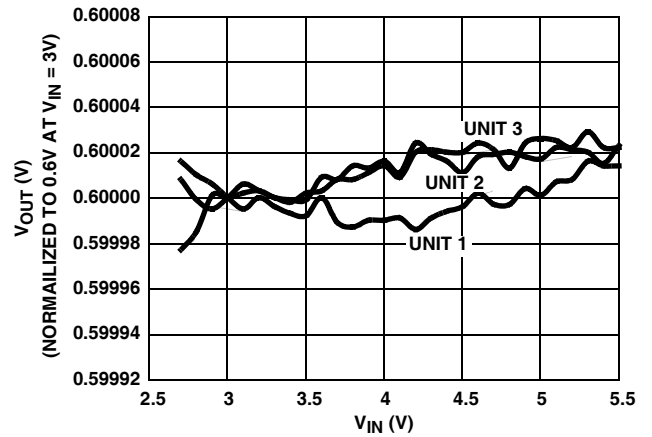

FIGURE 4. LINE REGULATION

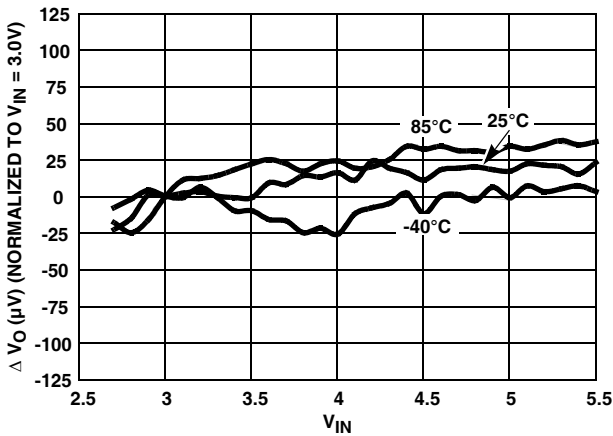

FIGURE 5. LINE REGULATION - 3 TEMPS

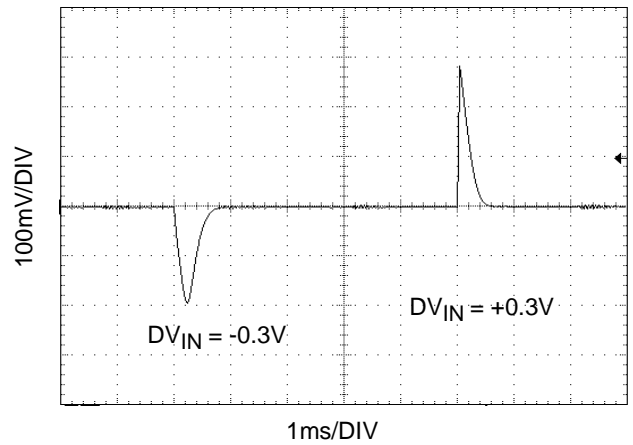

FIGURE 6. LINE TRANSIENT RESPONSE, $C_L = 0nF$

Typical Performance Curves, ISL21032 Low Voltage Output Reference

$V_{IN} = 3.0V$, $I_{OUT} = 0mA$, $T_A = 25^{\circ}C$ Unless Otherwise Specified (Continued)

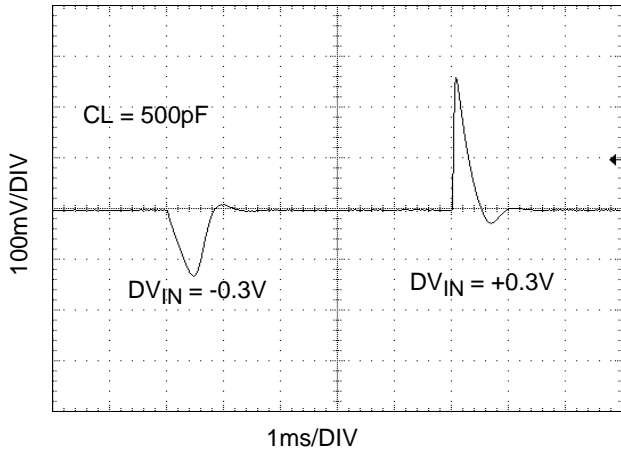

FIGURE 7. LINE TRANSIENT RESPONSE, $C_L = 1nF$

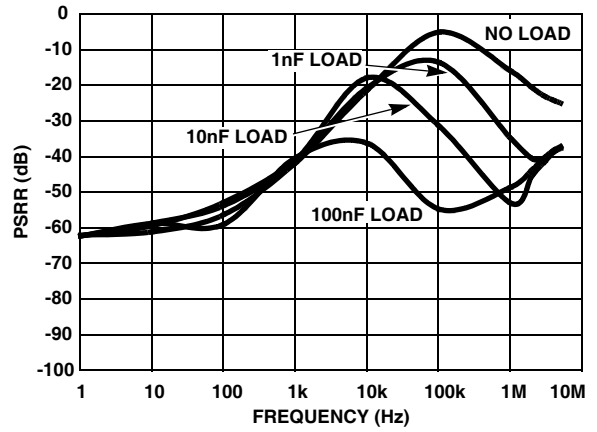

FIGURE 8. PSRR vs f vs C_L

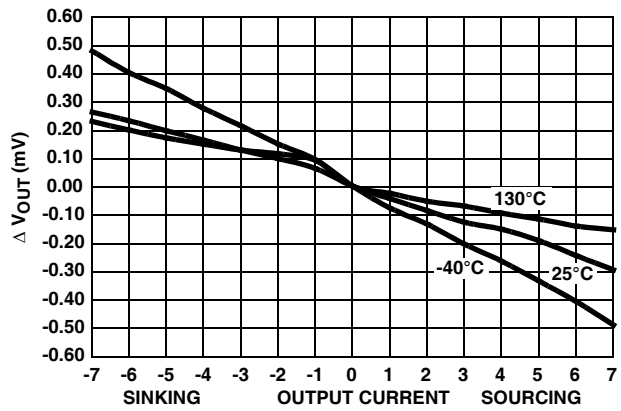

FIGURE 9. LOAD REGULATION vs TEMP

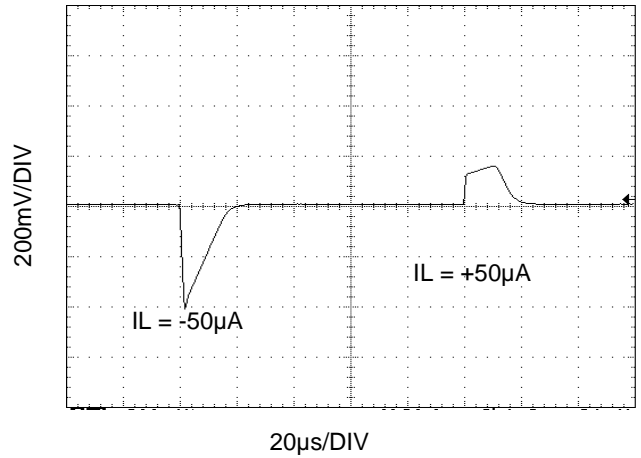

FIGURE 10. LOAD TRANSIENT RESPONSE @ $I_L = 50\mu A$, $C_L = 1nF$

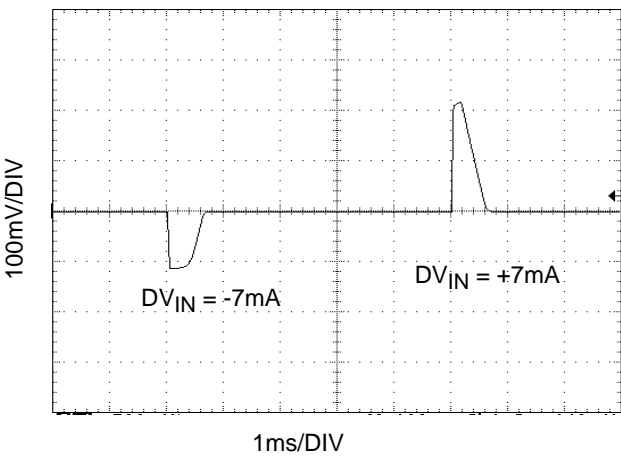

FIGURE 11. LOAD TRANSIENT RESPONSE @ $I_L = 7mA$, $C_L = 1nF$

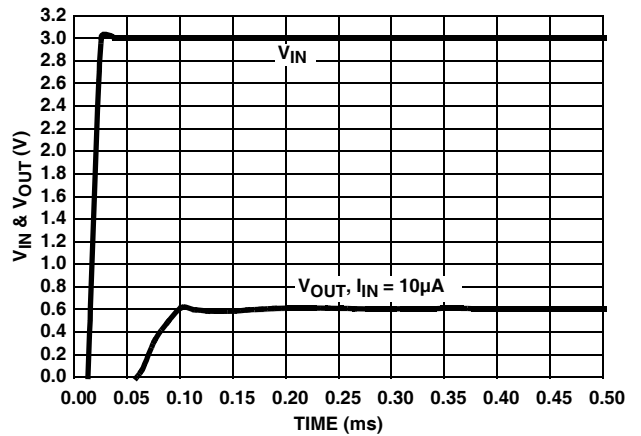

FIGURE 12. TURN-ON TIME @ $T_A = 25^{\circ}C$

Typical Performance Curves, ISL21032 Low Voltage Output Reference

$V_{IN} = 3.0V$, $I_{OUT} = 0mA$, $T_A = 25^\circ C$ Unless Otherwise Specified (Continued)

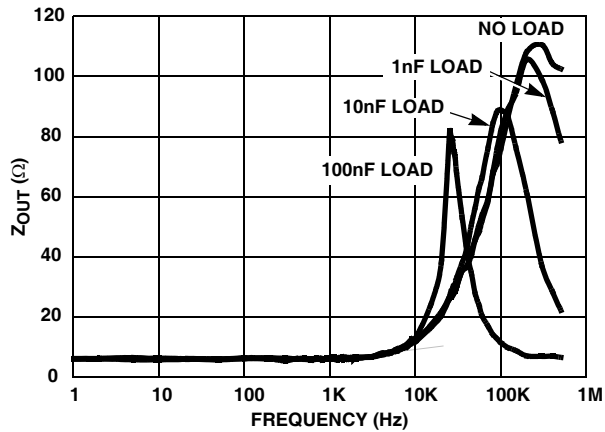

FIGURE 13. Z_{OUT} vs f vs C_L

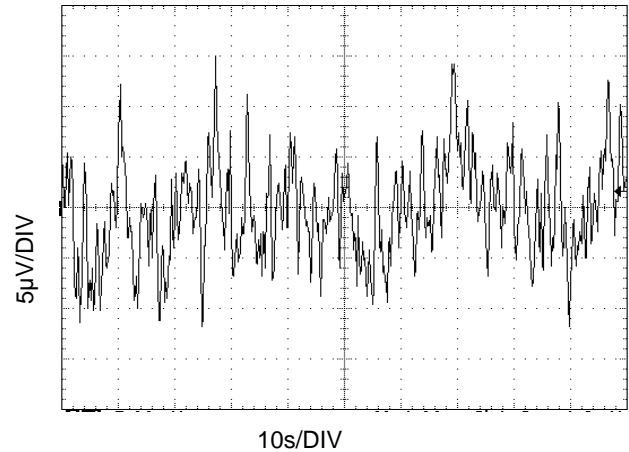

FIGURE 14. V_{OUT} NOISE

FGA Technology

The ISL21032 series of voltage references use the floating gate technology to create references with very low drift and supply current. Essentially the charge stored on a floating gate cell is set precisely in manufacturing. The reference voltage output itself is a buffered version of the floating gate voltage. The resulting reference device has excellent characteristics which are unique in the industry: very low temperature drift, high initial accuracy, and almost zero supply current. Also, the reference voltage itself is not limited by voltage bandgaps or zener settings, so a wide range of reference voltages can be programmed (standard voltage settings are provided, but customer-specific voltages are available).

The process used for these reference devices is a floating gate CMOS process, and the amplifier circuitry uses CMOS transistors for amplifier and output transistor circuitry. While providing excellent accuracy, there are limitations in output noise level and load regulation due to the MOS device characteristics. These limitations are addressed with circuit techniques discussed in other sections.

Board Mounting Considerations

For applications requiring the highest accuracy, board mounting location should be reviewed. Placing the device in areas subject to slight twisting can cause degradation of the accuracy of the reference voltage due to die stresses. It is normally best to place the device near the edge of a board, or the shortest side, as the axis of bending is most limited at that location. Obviously mounting the device on flexprint or extremely thin PC material will likewise cause loss of reference accuracy.

Noise Performance and Reduction

The output noise voltage in a 0.1Hz to 10Hz bandwidth is typically $30\mu V_{p-p}$. The noise measurement is made with a bandpass filter made of a 1 pole high-pass filter with a corner frequency at 0.1Hz and a 2-pole low-pass filter with a corner frequency at 12.6Hz to create a filter with a 9.9Hz bandwidth. Wideband noise is reduced by adding capacitor to the output, but the value should be limited to 1nF or less to insure stability.

Temperature Drift

The limits stated for output accuracy over temperature are governed by the method of measurement. For the $-40^\circ C$ to $130^\circ C$ temperature range, measurements are made at $25^\circ C$ and the two extremes. This measurement method combined with the fact that FGA references have a fairly linear temperature drift characteristic insures that the limits stated will not be exceeded over the temperature range.

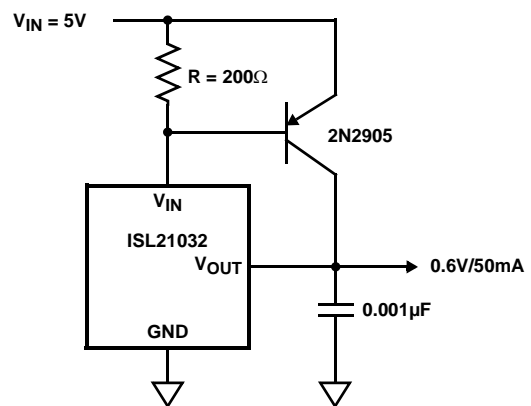
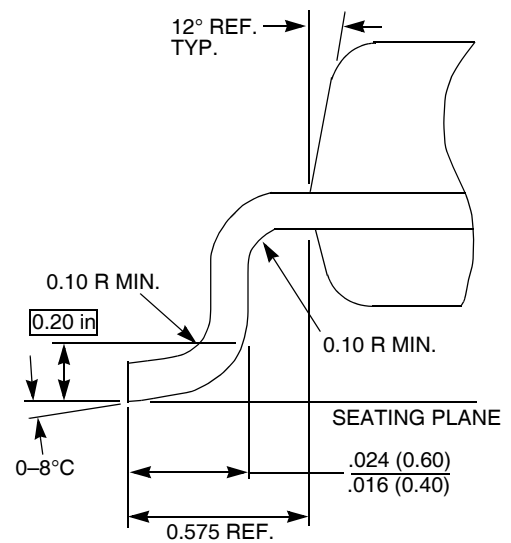
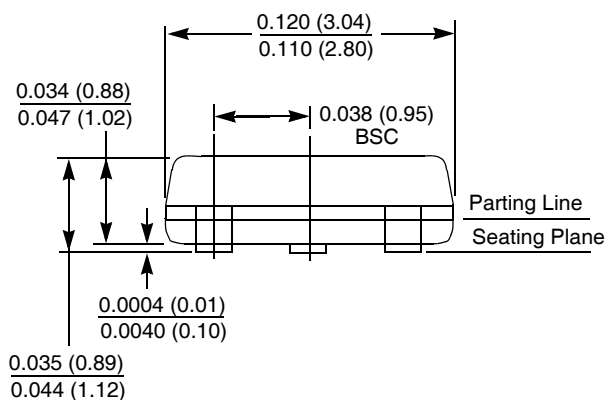
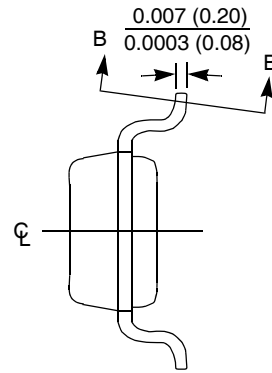
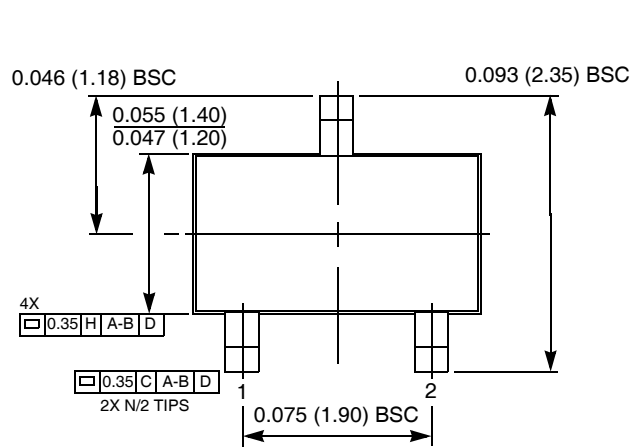

FIGURE 15. PRECISION LOW NOISE, LOW DRIFT, 0.6V, 50mA REFERENCE

Packaging Information

3-Lead, SOT23, Package Code H3



NOTES:

1. All dimensions in inches (in parentheses in millimeters).
2. Package dimensions exclude molding flash.
3. Die and die paddle is facing down towards seating plane.
4. This part is compliant with JEDEC Specification TO-236AB.
5. Dimensioning and tolerances per ASME, Y14.5M-1994.

All Intersil U.S. products are manufactured, assembled and tested utilizing ISO9000 quality systems.

Intersil Corporation's quality certifications can be viewed at www.intersil.com/design/quality

Intersil products are sold by description only. Intersil Corporation reserves the right to make changes in circuit design, software and/or specifications at any time without notice. Accordingly, the reader is cautioned to verify that data sheets are current before placing orders. Information furnished by Intersil is believed to be accurate and reliable. However, no responsibility is assumed by Intersil or its subsidiaries for its use; nor for any infringements of patents or other rights of third parties which may result from its use. No license is granted by implication or otherwise under any patent or patent rights of Intersil or its subsidiaries.

For information regarding Intersil Corporation and its products, see www.intersil.com