



FSL336LR Green Mode Fairchild Buck Switch

Features

- Built-in Avalanche-Rugged SenseFET: 650 V
- Fixed Operating Frequency: 50 kHz
- No-Load Power Consumption:
<25 mW at 230 V_{AC} with External Bias;
<120 mW at 230 V_{AC} without External Bias
- No Need for Auxiliary Bias Winding
- Frequency Modulation for Attenuating EMI
- Pulse-by-Pulse Current Limiting
- Ultra-Low Operating Current: 250 μA
- Built-in Soft-Start and Startup Circuit
- Adjustable Peak Current Limit
- Built-in Transconductance (Error) Amplifier
- Various Protections: Overload Protection (OLP), Over-Voltage Protection (OVP), Feedback Open-Loop Protection (FB_OLP), Thermal Shutdown (TSD)
- Fixed 650 ms Restart Time for Safe Auto-Restart of All Protections

Description

The FSL336LR integrated Pulse Width Modulator (PWM) and SenseFET is specifically designed for high-performance offline buck, buck-boost, and non-isolation flyback Switched Mode Power Supplies (SMPS) with minimal external components. This device integrates a high-voltage power regulator that enables operation without auxiliary bias winding. An internal transconductance amplifier reduces external components for the feedback compensation circuit.

The integrated PWM controller includes: 10 V regulator for no external bias circuit, Under-Voltage Lockout (UVLO), Leading-Edge Blanking (LEB), an optimized gate turn-on / turn-off driver, EMI attenuator, Thermal Shutdown (TSD), temperature-compensated precision current sources for loop compensation, and fault-protection circuitry. Protections include: Overload Protection (OLP), Over-Voltage Protection (OVP), and Feedback Open Loop Protection (FB_OLP). FSL336LR offers good soft-start performance during startup.

The internal high-voltage startup switch and the Burst-Mode operation with very low operating current reduce the power loss in Standby Mode. As the result, it is possible to reach power loss of 120 mW without external bias and 25 mW with external bias when input voltage is 230 V_{AC}.

Applications

- SMPS for Home Appliances and Industrial Applications
- SMPS for Auxiliary Power

Ordering Information

Part Number	Operating Junction Temperature	PKG	Packing Method	Typical Output Power ⁽¹⁾			
				Current Limit	R _{DS(ON),MAX}	85 V _{AC} ~ 265 V _{AC} & Open Frame ⁽²⁾	
						Buck Application ⁽³⁾	Flyback Application
FSL336LRN	-40°C ~125°C	7-DIP	Rail	1.8 A	4 Ω	9 W	20 W
FSL336LRLX		7-LSOP	Tape & Reel				

Notes:

1. The junction temperature can limit the maximum output power.
2. Maximum practical continuous power in an open-frame design at 50°C ambient.
3. Based on 15 V output voltage condition. Output voltage can limit the maximum output power.

Application Diagrams

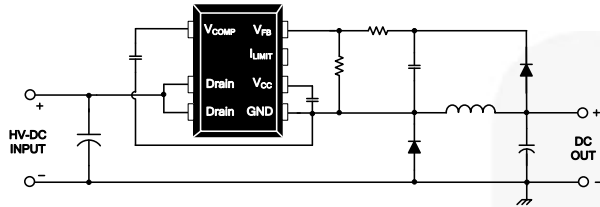

Figure 1. Buck Converter Application

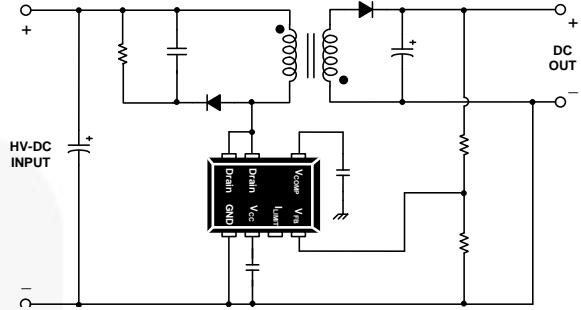

Figure 2. Non-Isolation Flyback Converter Application

Block Diagram

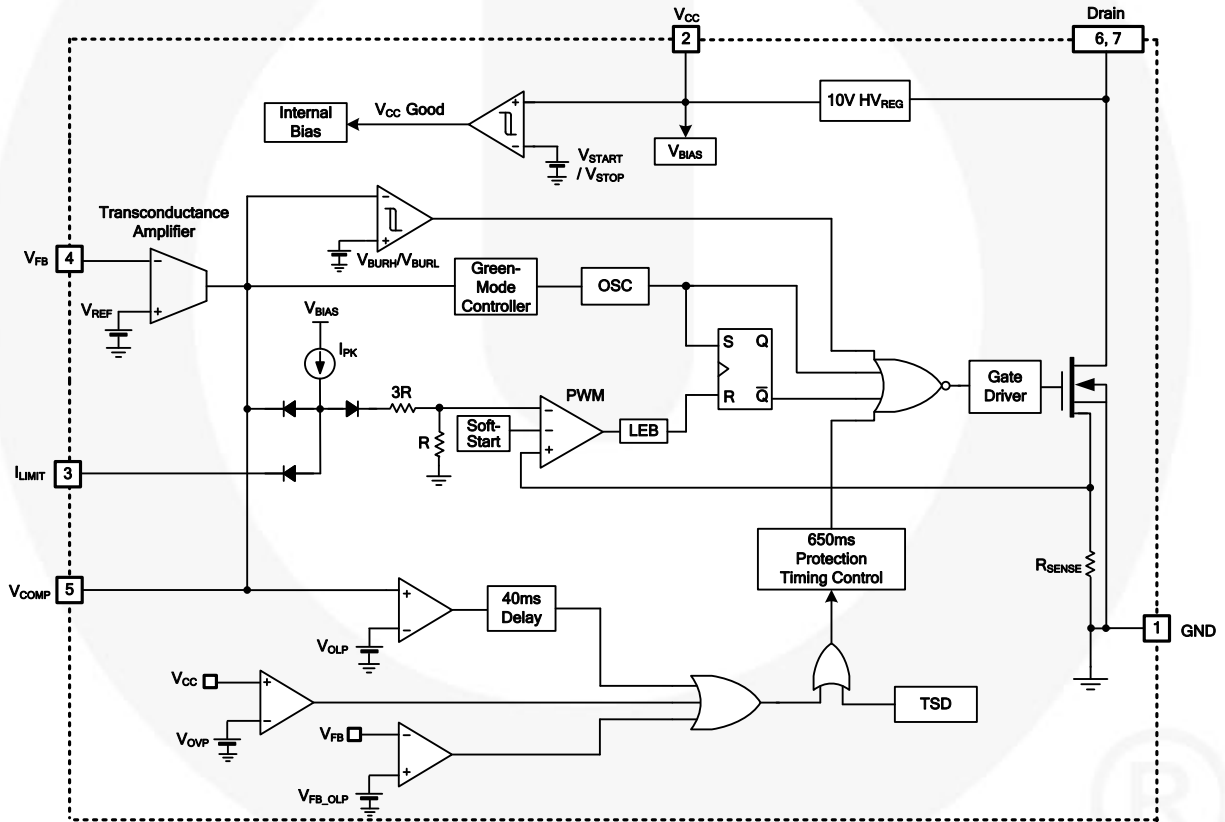

Figure 3. Internal Block Diagram

Pin Configuration

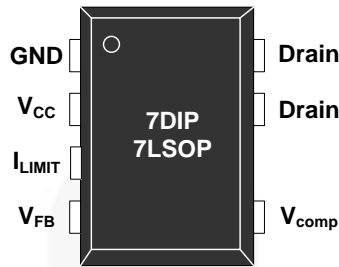

Figure 4. Pin Configuration

Pin Definitions

Pin #	Name	Description
1	GND	Ground. SenseFET source terminal on the primary side and internal control ground.
2	V _{CC}	Positive Supply Voltage Input. This pin is the positive supply input that provides the internal operating current for startup and steady-state operation. This pin voltage is regulated to 10 V, without the external bias circuit, via an internal switch (see Figure 3). When the external bias voltage is >10 V, it disables the internal high-voltage regulator to reduce power consumption.
3	I _{LIMIT}	Peak Current Limit. Adjusts the peak current limit of the SenseFET. The internal 50 μA current source is diverted to the parallel combination of an internal 46 kΩ (3R + R) resistor and any external resistor to GND on this pin to determine the peak current limit.
4	V _{FB}	Feedback Voltage. Inverting input of the transconductance amplifier. This pin controls the converter output voltage by outputting a current proportional to the difference between the reference voltage and the output voltage divided by external resistors.
5	V _{COMP}	Comp Voltage. Output of the transconductance amplifier. The compensation networks are placed between the V _{COMP} and GND pins to achieve stability and good dynamic performance.
6, 7	Drain	Drain. High-voltage power SenseFET drain connection. In addition, during startup and steady-state operation; the internal high-voltage current source supplies internal bias and charges the external capacitor connected to the V _{CC} pin. Once V _{CC} reaches 8 V, all internal blocks are activated. The internal high-voltage current source is enabled until V _{CC} reaches 10 V. After that, the internal high-voltage regulator turns on and off regularly to maintain V _{CC} at 10 V.

Absolute Maximum Ratings

Stresses exceeding the absolute maximum ratings may damage the device. The device may not function or be operable above the recommended operating conditions and stressing the parts to these levels is not recommended. In addition, extended exposure to stresses above the recommended operating conditions may affect device reliability. The absolute maximum ratings are stress ratings only. $T_A = 25\text{ }^\circ\text{C}$, unless otherwise specified.

Symbol	Parameter	Min.	Max.	Unit
V_{DS}	Drain Pin Voltage	-0.3	650.0	V
V_{CC}	Supply Voltage	-0.3	26.0	V
V_{COMP}	V_{COMP} Pin Voltage	-0.3	Internally Clamped Voltage ⁽⁴⁾	V
V_{FB}	Feedback Voltage	-0.3	12.0	V
I_{LIMIT}	Current Limit Pin Voltage	-0.3	12.0	V
I_{DM}	Drain Current Pulsed ⁽⁵⁾		12	A
E_{AS}	Single Pulsed Avalanche Energy ⁽⁶⁾		230	mJ
P_D	Total Power Dissipation		1.25	W
T_J	Operating Junction Temperature ⁽⁷⁾	-40	125	$^\circ\text{C}$
	Maximum Junction Temperature		150	$^\circ\text{C}$
T_{STG}	Storage Temperature	-55	150	$^\circ\text{C}$

Notes:

- V_{COMP} is clamped by internal clamping diode (11 V, $I_{CLAMP_MAX} < 100\text{ }\mu\text{A}$)
- Repetitive rating: pulse width is limited by maximum junction temperature.
- $L=51\text{ mH}$, starting $T_J=25\text{ }^\circ\text{C}$.
- Although this parameter guarantees IC operation, it does not guarantee all electrical characteristics.

Thermal Impedance

$T_A=25\text{ }^\circ\text{C}$ unless otherwise specified.

Symbol	Parameter	Value	Unit
θ_{JA}	Junction-to-Ambient Thermal Impedance ⁽⁸⁾	100	$^\circ\text{C/W}$

Notes:

- JEDEC recommended environment, JESD51-2, and test board, JESD51-3, with minimum land pattern.

ESD Capability

Symbol	Parameter	Value	Unit
ESD	Human Body Model, ANSI/ESDA/JEDEC JS-001-2012 ⁽⁹⁾	4	kV
	Charged Device Model, JESD22-C101 ⁽⁹⁾	2	

Note:

- Meets JEDEC standards ANSI/ESDA/JEDEC JS-001-2012 and JESD 22-C101.

Electrical Characteristics

$T_A = 25^\circ\text{C}$ unless otherwise specified.

Symbol	Parameter	Conditions	Min.	Typ.	Max.	Unit
SenseFET Section						
BV_{DSS}	Drain-Source Breakdown Voltage	$V_{CC} = 0\text{ V}, I_D = 250\ \mu\text{A}$	650			V
I_{DSS}	Zero Gate Voltage Drain Current	$V_{DS} = 520\text{ V}, T_A = 125^\circ\text{C}$			250	μA
$R_{DS(ON)}$	Drain-Source On-State Resistance	$V_{GS} = 10\text{ V}, I_D = 1\text{ A}$		3.5	4.0	Ω
C_{ISS}	Input Capacitances	$V_{GS} = 0\text{ V}, V_{DS} = 25\text{ V}, f = 1\text{ MHz}$		290		pF
C_{OSS}	Output Capacitance	$V_{GS} = 0\text{ V}, V_{DS} = 25\text{ V}, f = 1\text{ MHz}$		45		pF
C_{RSS}	Reverse Transfer Capacitance	$V_{GS} = 0\text{ V}, V_{DS} = 25\text{ V}, f = 1\text{ MHz}$		5.5		pF
t_r	Rise Time	$V_{DD} = 350\text{ V}, I_D = 3.5\text{ A}$		22		ns
t_f	Fall Time	$V_{DD} = 350\text{ V}, I_D = 3.5\text{ A}$		19		ns
Control Section						
f_{OSC}	Switching Frequency	$V_{COMP} = 2.5\text{ V}$	45	50	55	kHz
f_M	Frequency Modulation ⁽¹⁰⁾	$V_{COMP} = 2.5\text{ V}, \text{Randomly}$		± 3		kHz
$t_{on,max}$	Maximum Turn-On Time	$V_{COMP} = 2.5\text{ V}$	11.2	13.3	15.4	μs
V_{START}	UVLO Threshold Voltage	$V_{COMP} = 0\text{ V}, V_{CC}\text{ Sweep}$	7.2	8.0	8.8	V
V_{STOP}		After Turn On	6.3	7.0	7.7	V
I_{PK}	Current Limit Source Current	$V_{COMP} = 2.5\text{ V}$	35	50	65	μA
t_{SS}	Soft-Start Time	$V_{COMP} = 2.5\text{ V}$	7	10	13	ms
Burst Mode Section						
V_{BURH}	Burst-Mode HIGH Threshold Voltage	$V_{CC} = 15\text{ V}, V_{COMP}\text{ Increase}$	0.58	0.65	0.72	V
V_{BURL}	Burst-Mode LOW Threshold Voltage	$V_{CC} = 15\text{ V}, V_{COMP}\text{ Decrease}$	0.52	0.59	0.66	V
HYS_{BUR}	Burst-Mode Hysteresis			60		mV
Protection Section						
I_{LIM}	Peak Current Limit	$V_{COMP} = 2.5\text{ V}, di/dt = 1.2\text{ A}/\mu\text{s}$	1.6	1.8	2.0	A
t_{CLD}	Current Limit Delay ⁽¹⁰⁾			200		ns
V_{OLP}	Overload Protection	$V_{COMP}\text{ Increase}$	2.7	3.0	3.3	V
t_{LEB}	Leading-Edge Blanking Time ⁽¹⁰⁾			200		ns
V_{FB_OLP}	FB Open-Loop Protection	$V_{FB}\text{ Decrease}$	0.4	0.5	0.6	V
V_{OVP}	Over-Voltage Protection	$V_{CC}\text{ Increase}$	23.0	24.5	26.0	V
TSD	Thermal Shutdown Temperature ⁽¹⁰⁾		125	135	150	$^\circ\text{C}$
HYS_{TSD}	TSD Hysteresis Temperature ⁽¹⁰⁾			60		$^\circ\text{C}$
t_{DELAY}	Overload Protection Delay ⁽¹⁰⁾	$V_{COMP} > 3\text{ V}$		40		ms
$t_{RESTART}$	Restart Time After Protection ⁽¹⁰⁾			650		ms
Transconductance Amplifier Section						
G_m	Transconductance of Error Amplifier		380	480	580	μmho
V_{REF}	Voltage Feedback Reference		2.45	2.50	2.55	V
$I_{EA,SR}$	Output Sourcing Current	$V_{FB} = V_{REF} - 0.025\text{ V}$		-12		μA
$I_{EA,SK}$	Output Sink Current	$V_{FB} = V_{REF} + 0.025\text{ V}$		12		μA

Continued on the following page...

Electrical Characteristics

T_A = 25°C unless otherwise specified.

Symbol	Parameter	Conditions	Min.	Typ.	Max.	Unit
High-Voltage Regulator Section						
V _{HVREG}	HV Regulator Voltage	V _{COMP} = 0 V, V _{DRAIN} = 40 V	9	10	11	V
Total Device Section						
I _{OP1}	Operating Supply Current (Control Part Only, without Switching)	0 V < V _{COMP} < V _{BURL}		0.25	0.35	mA
I _{OP2}	Operating Supply Current (While Switching)	V _{BURL} < V _{COMP} < V _{OLP}		0.8	1.3	mA
I _{CH}	Startup Charging Current	V _{CC} = 0 V, V _{DRAIN} > 40 V		6		mA
I _{START}	Startup Current	V _{CC} = Before V _{START} , V _{COMP} = 0 V		120	155	μA
V _{DRAIN}	Minimum Drain Supply Voltage	V _{CC} = V _{COMP} = 0 V, V _{DRAIN} Increase		35		V

Note:

10. Though guaranteed by design; not 100% tested in production.

Typical Performance Characteristics

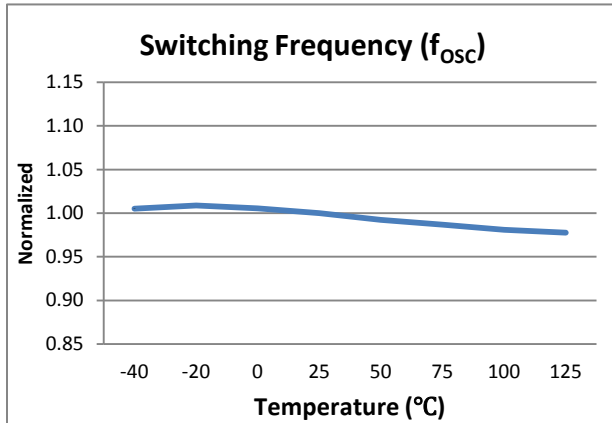

Figure 5. Operating Frequency vs. Temperature

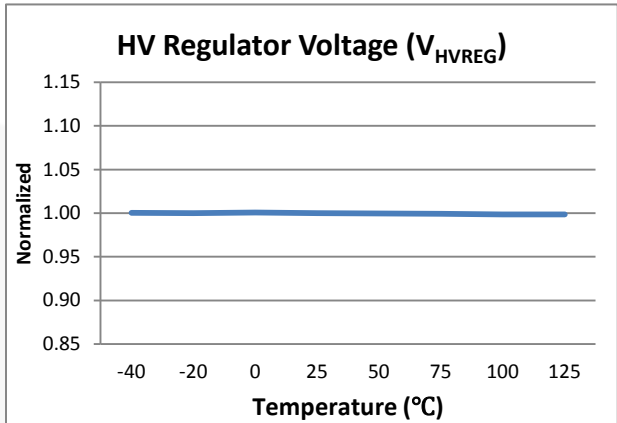

Figure 6. HV Regulator Voltage vs. Temperature

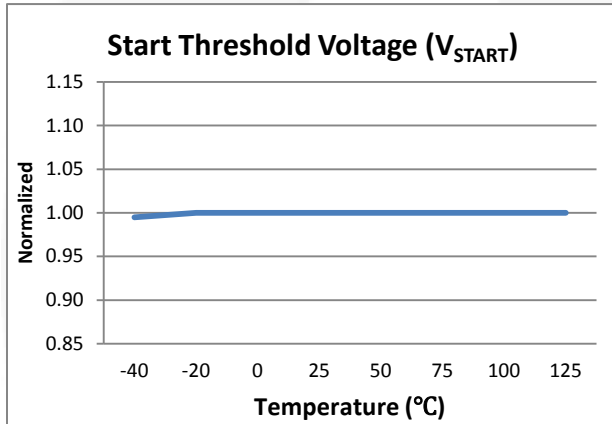

Figure 7. Start Threshold Voltage vs. Temperature

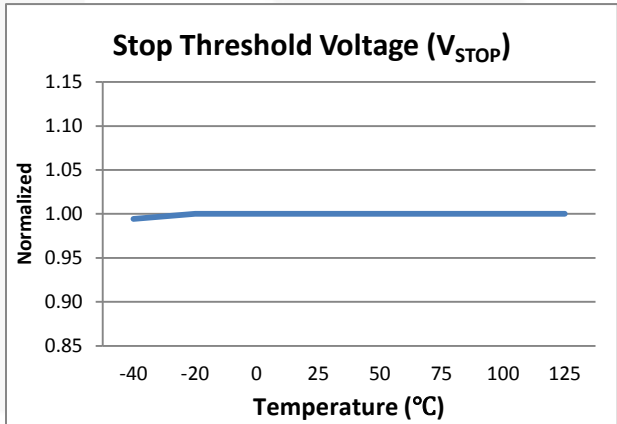

Figure 8. Stop Threshold Voltage vs. Temperature

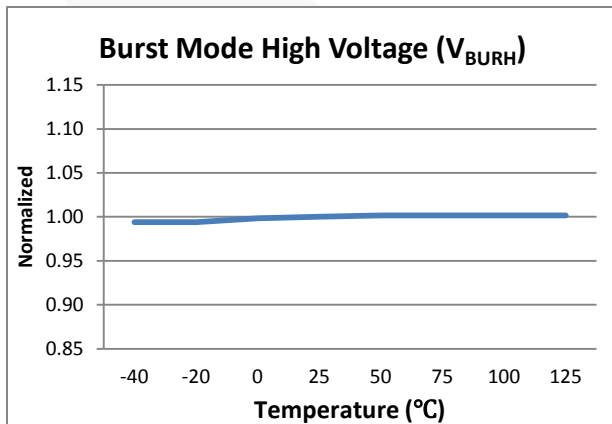

Figure 9. Burst Mode High Voltage vs. Temperature

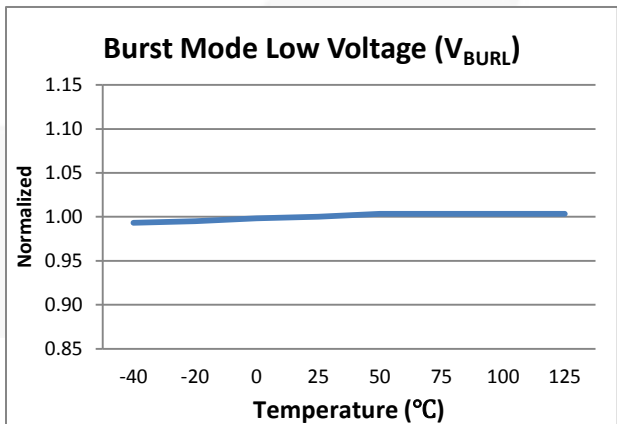

Figure 10. Burst Mode Low Voltage vs. Temperature

Typical Performance Characteristics (Continued)

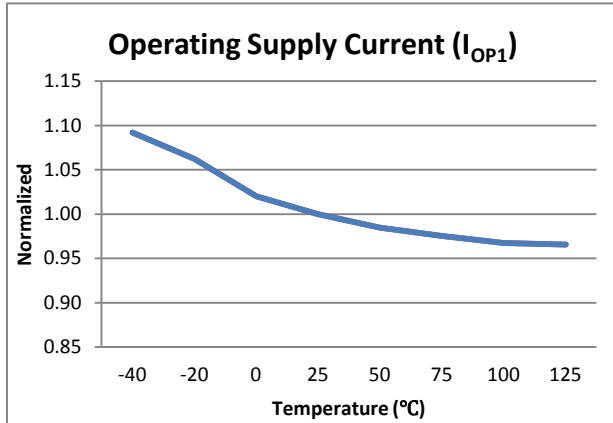

Figure 11. Operating Supply Current 1 vs. Temperature

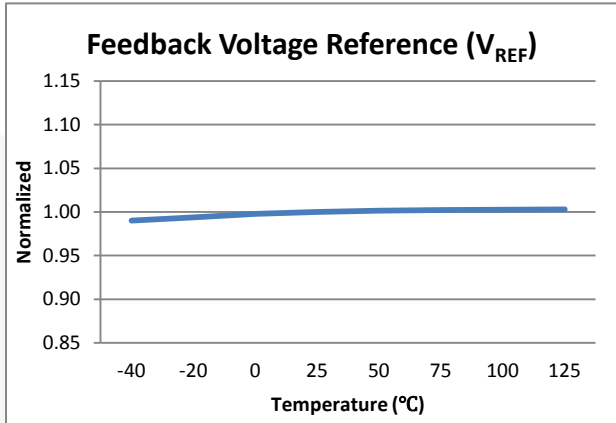

Figure 12. Feedback Voltage Reference vs. Temperature

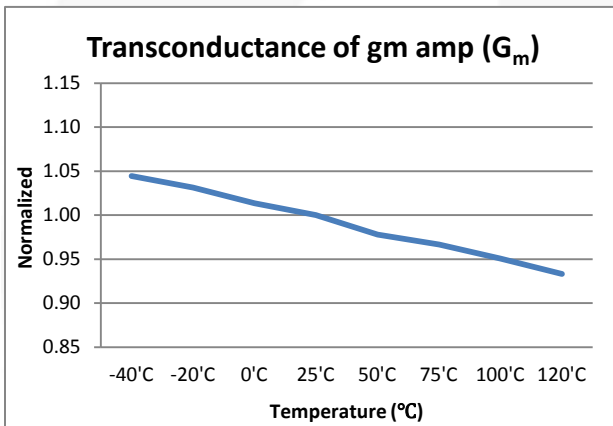

Figure 13. Transconductance of gm Amplifier vs. Temperature

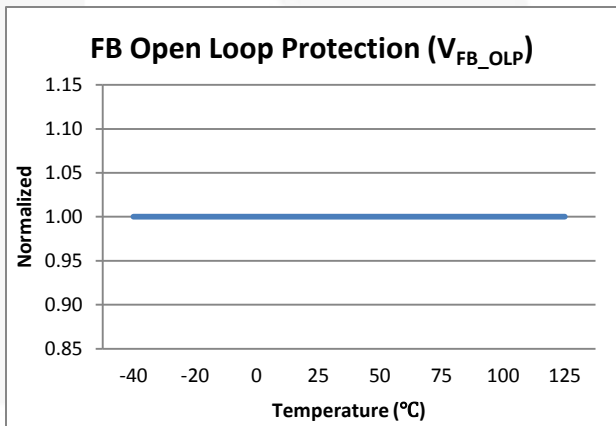

Figure 14. FB Open-Loop Protection Voltage vs. Temperature

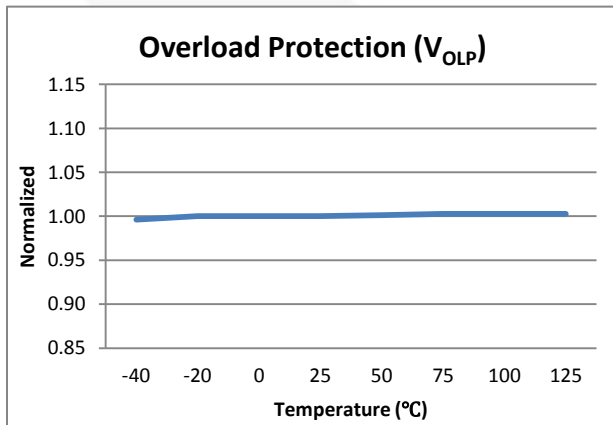

Figure 15. Overload Protection vs. Temperature

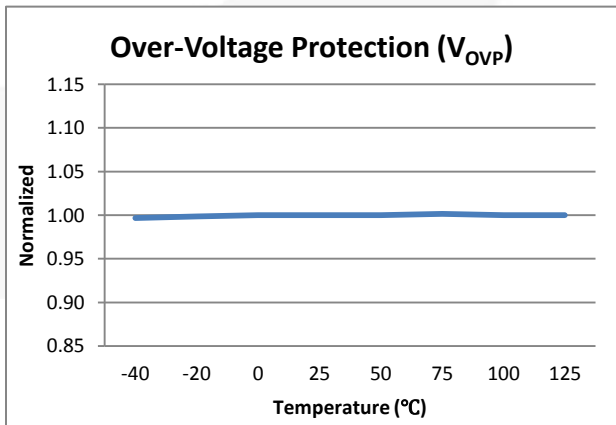

Figure 16. Over-Voltage Protection vs. Temperature

Functional Description

1. Startup and High-Voltage Regulator

During startup, an internal high-voltage current source (I_{CH}) of the high-voltage regulator supplies the internal bias current (I_{START}) and charges the external capacitor (C_A) connected to the V_{CC} pin, as illustrated in Figure 17. This internal high-voltage current source is enabled until V_{CC} reaches 10 V. During steady-state operation, this internal high-voltage regulator (HV_{REG}) maintains the V_{CC} with 10 V and provides operating current (I_{OP}) for all internal circuits. Therefore, no external bias circuit is necessary. The high-voltage regulator is disabled when the external bias is higher than 10 V.

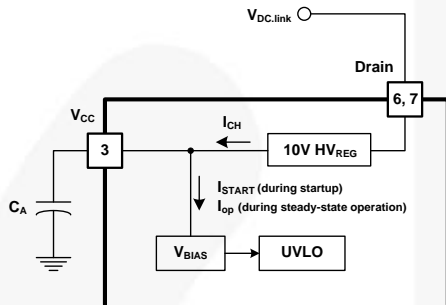

Figure 17. Startup and HV_{REG} Block

2. Oscillator Block

The oscillator frequency is set internally with a random frequency fluctuation function. Fluctuation of the switching frequency can reduce Electro-Magnetic Induction (EMI) by spreading the energy over a wider frequency range than the bandwidth measured by the EMI test equipment. The amount of EMI reduction is directly related to the range of the frequency variation. The range of frequency variation is fixed internally; however, its selection is randomly chosen by the combination of an external feedback voltage and an internal free-running oscillator. This randomly chosen switching frequency effectively spreads the EMI noise near switching frequency and allows the use of a cost-effective inductor instead of an AC input line filter to satisfy world-wide EMI requirements.

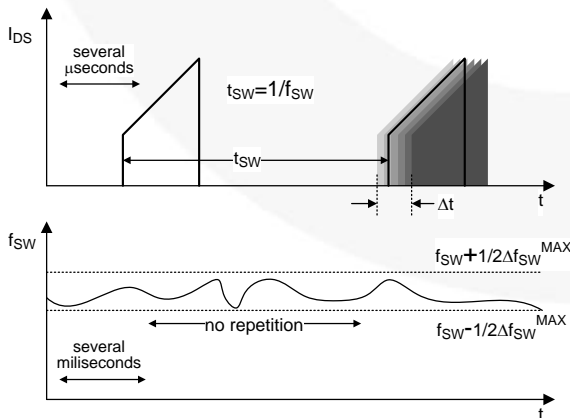

Figure 18. Frequency Fluctuation Waveform

3. Feedback Control

The FSL336LR employs current-mode control with a transconductance amplifier for feedback control, as shown in Figure 19. Two resistors are typically used on the V_{FB} pin to sense output voltage. An external compensation circuit is recommended on the V_{COMP} pin to control output voltage. A built-in transconductance amplifier accurately controls output voltage without external components, such as Zener diode and transistor.

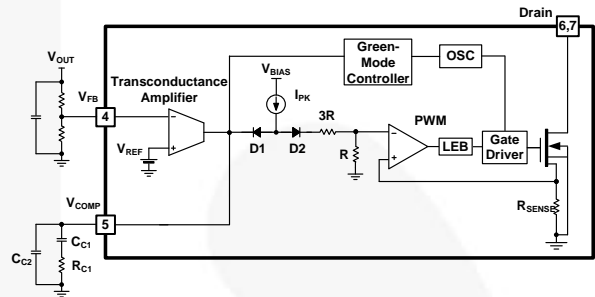

Figure 19. Pulse Width Modulation (PWM) Circuit

3.1 Transconductance Amplifier (gm Amplifier)

The output of the transconductance amplifier sources and sinks the current, respectively, to and from the compensation circuit connected on the V_{COMP} pin (see Figure 20). This compensated V_{COMP} pin voltage controls the switching duty cycle by comparing with the voltage across the R_{SENSE} . When the feedback pin voltage exceeds the internal reference voltage (V_{REF}) of 2.5 V; the transconductance amplifier sinks the current from the compensation circuit, V_{COMP} is pulled down, and the duty cycle is reduced. This typically occurs when input voltage is increased or output load is decreased. A two-pole and one-zero compensation network is recommended for optimal output voltage control and AC dynamics. Typically 220 nF, 75 k Ω , and 220 pF are used for C_{C1} , R_{C1} , and C_{C2} ; respectively.

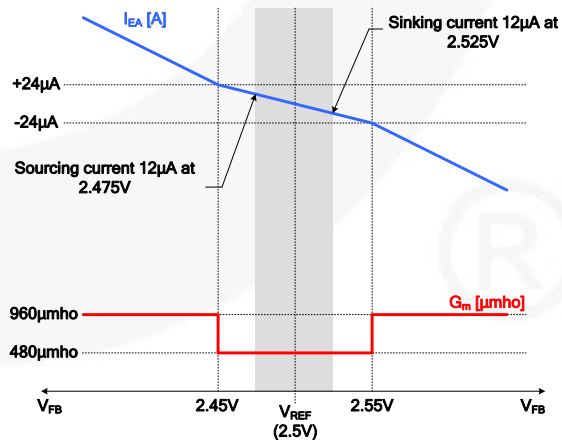

Figure 20. Characteristics of gm Amplifier

3.2 Pulse-by-Pulse Current Limit

Because current-mode control is employed, the peak current flowing through the SenseFET is limited by the inverting input of PWM comparator, as shown in Figure 19. Assuming that 50 μ A current source flows only through the internal resistors ($3R + R = 46 \text{ k}\Omega$), the cathode voltage of diode D2 is about 2.4 V. Since D1 is blocked when V_{COMP} exceeds 2.4 V, the maximum voltage of the cathode of D2 is clamped at this voltage. Therefore, the peak value of the current of the SenseFET is limited.

3.3 Leading Edge Blanking (LEB)

At the instant the internal SenseFET is turned on, a high-current spike through the SenseFET is typically caused by: primary-side capacitance and secondary-side rectifier diode reverse recovery of flyback application, the freewheeling diode reverse recovery, and other parasitic capacitance of buck application. Excessive voltage across the sensing resistor (R_{SENSE}) leads to incorrect feedback operation in the current-mode control. To counter this effect, the FSL336LR has a Leading-Edge Blanking (LEB) circuit (see Figure 19). This circuit inhibits the PWM comparator for a short time (t_{LEB}) after the SenseFET is turned on.

4. Protection Circuits

The protective functions include Overload Protection (OLP), Over-Voltage Protection (OVP), Under-Voltage Lockout (UVLO), Feedback Open-Loop Protection (FB_OLP), and Thermal Shutdown (TSD). All of the protections operate in Auto-Restart Mode. Since these protection circuits are fully integrated within the IC without external components, reliability is improved without increasing cost or PCB space. If a fault condition occurs, switching is terminated and the SenseFET remains off. At the same time, internal protection timing control is activated to decrease power consumption and stress on passive and active components during Auto-Restart Mode. When internal protection timing control is activated, V_{CC} is regulated with 10 V through the internal high-voltage regulator until switching is terminated. This internal protection timing control continues until the restart time (650 ms) expires. After 650 ms, the internal high-voltage regulator is disabled and V_{CC} is decreased. When V_{CC} reaches the UVLO stop voltage V_{STOP} (7 V), the protection is reset and the internal high-voltage current source charges the V_{CC} capacitor via the drain pin again. When V_{CC} reaches the UVLO start voltage, V_{START} (8 V), normal operation resumes. In this manner, Auto-Restart Mode can alternately enable and disable the switching of the power SenseFET until the fault condition is eliminated.

4.1 Overload Protection (OLP)

Overload is defined as the load current exceeding a pre-set level due to an unexpected event. In this situation, the protection circuit should be activated to protect the SMPS. However, when the SMPS operates normally, the OLP circuit can be enabled during load transition or startup. To avoid this undesired operation, an internal fixed delay (40 ms) circuit determines whether it is a transient situation or a true overload situation (see Figure 21). The current-mode feedback path limits the maximum power current and, when the output

consumes more than this maximum power, the output voltage (V_{O}) decreases below its rated voltage. This reduces feedback pin voltage, which increases the output current of the internal transconductance amplifier. Eventually V_{COMP} is increased. When V_{COMP} reaches 3 V, the internal fixed OLP delay (40 ms) is activated. After this delay, the switching operation is terminated, as shown in Figure 22.

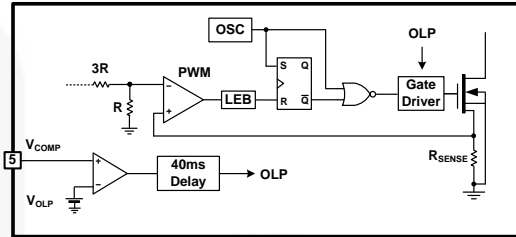

Figure 21. Overload Protection Internal Circuit

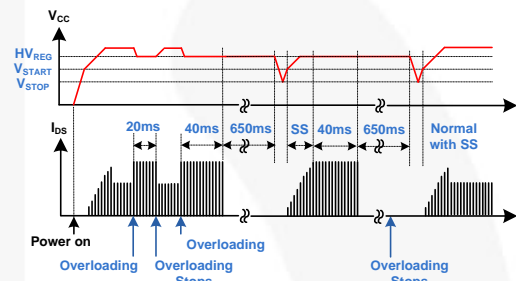

Figure 22. Overload Protection (OLP) Waveform

4.2 Thermal Shutdown (TSD)

The SenseFET and control IC integrated on the same package makes it easier to detect the temperature of the SenseFET. When the junction temperature exceeds 135°C, thermal shutdown is activated. The FSL336LR is restarted after the temperature decreases to 60°C.

4.3 Over-Voltage Protection (OVP)

If any feedback loop components fail due to a soldering defect, V_{COMP} climbs up in manner similar to the overload situation, forcing the preset maximum current to be supplied to the SMPS until the OLP is triggered. In this case, excessive energy is provided to the output and the output voltage may exceed the rated voltage before the OLP is activated. To prevent this situation, an Over-Voltage Protection (OVP) circuit is employed. In general, output voltage can be monitored through V_{CC} and, when V_{CC} exceeds 24.5 V, OVP is triggered, resulting in termination of switching operation. To avoid undesired activation of OVP during normal operation, V_{CC} should be designed below 24.5 V (see Figure 23).

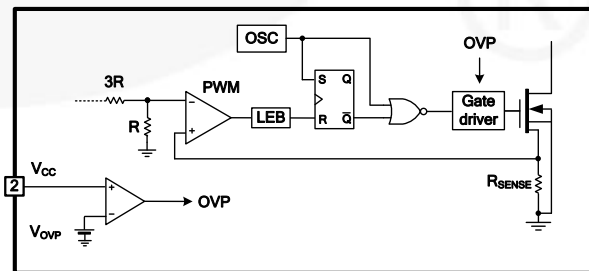

Figure 23. Over-Voltage Protection Circuit

4.4 Feedback Open Loop Protection (FB_OLP)

In the event of a feedback loop failure, especially a shorted lower-side resistor of the feedback pin; not only does V_{COMP} rise in a similar manner to the overload situation, but V_{FB} starts to drop to IC ground level. Although OLP and OVP also can protect the SMPS in this situation, FB_OLP can reduce stress on SenseFET. If there is no FB_OLP, output voltage is much higher than the rated voltage before OLP or OVP triggers. When V_{FB} drops below 0.5 V, FB_OLP is activated, switching off. To avoid undesired activation during startup, this function is disabled during soft-start time.

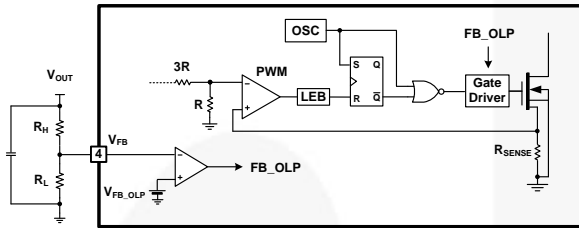

Figure 24. Feedback Open-Loop Protection Circuit

5. Soft-Start

The internal soft-start circuit slowly increases the SenseFET current after it starts. The typical soft-start time is 10 ms, as shown in Figure 25, where progressive increments of the SenseFET current are allowed during startup. The pulse width to the power switching device is progressively increased to establish the correct working conditions for transformers, inductors, and capacitors. The voltage on the output capacitors is gradually increased to smoothly establish the required output voltage. Soft-start also helps to prevent transformer saturation and reduces stress on the secondary diode.

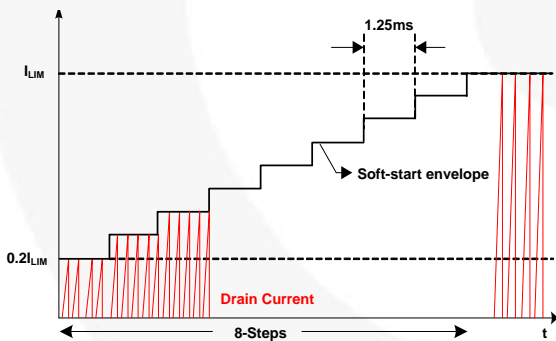

Figure 25. Internal Soft-Start

6. Burst Mode Operation

To minimize power dissipation in Standby Mode, the FSL336LR enters Burst Mode. As the load decreases, the COMP pin voltage (V_{COMP}) decreases. As shown in Figure 26, the device automatically enters Burst Mode when the feedback voltage drops below V_{BURL} . At this point, switching stops and the output voltages start to drop at a rate dependent on the standby current load. This causes V_{COMP} to rise. Once it passes V_{BURH} , switching resumes. V_{COMP} then falls and the process repeats. Burst Mode alternately enables and disables switching of the SenseFET and reduces switching loss in Standby Mode.

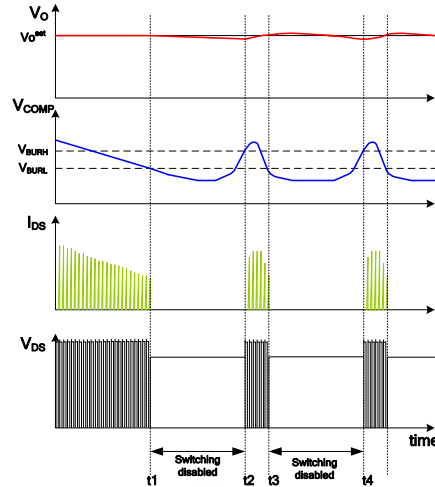

Figure 26. Burst Mode Operation

7. Green Mode Operation

As output load condition is reduced, the switching loss becomes the largest power loss factor. FSL306LR uses the V_{COMP} pin voltage to monitor output load condition. As output load decreases, V_{COMP} decreases and switching frequency declines, as shown in Figure 27. Once V_{COMP} falls to 0.8 V, the switching frequency varies between 21 kHz and 23 kHz before Burst Mode operation. At Burst Mode operation, random frequency fluctuation still functions.

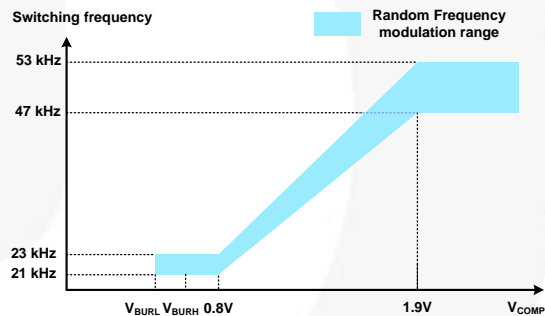

Figure 27. Green Mode Operation

8. Adjusting Current Limit

As shown in Figure 28, a combined $46 \text{ k}\Omega$ internal resistance ($3R + R$) is connected to the inverting lead on the PWM comparator. An external resistance of R_x on the I_{LIMIT} pin forms a parallel resistance with the $46 \text{ k}\Omega$ when the internal diodes are biased by the main current source of $50 \mu\text{A}$. For example, FSL336LR has a typical SenseFET peak current limit of 1.8 A. Current limit can be adjusted to 1.2 A by inserting R_x between the I_{LIMIT} pin and the ground. The value of the R_x can be estimated by the following equation:

$$1.8 \text{ A} : 1.2 \text{ A} = (46 \text{ k}\Omega + R_x) : R_x \quad (1)$$

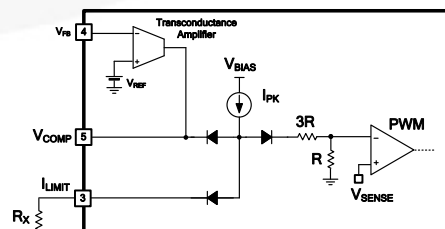
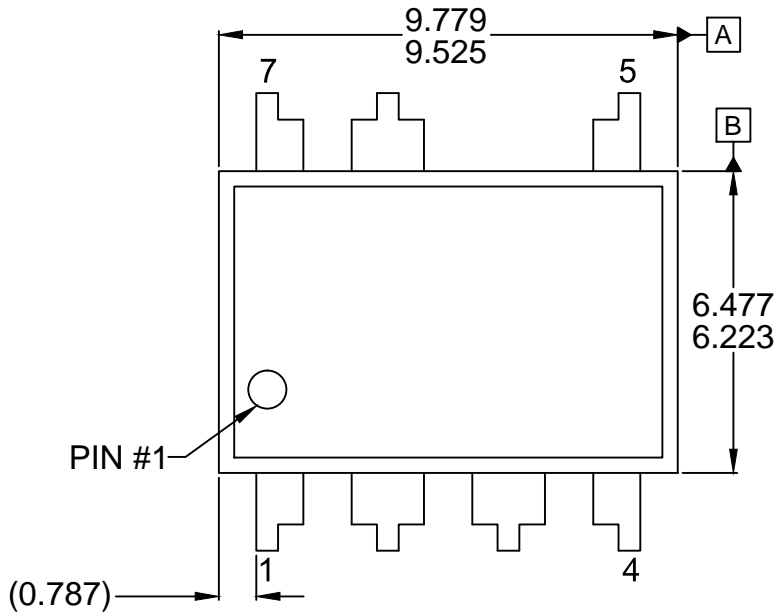

Figure 28. Current Limit Adjustment



TOP VIEW

NOTES :

- A. REFERENCE JEDEC MS-001, VARIATION BA EXCEPT FOR NUMBER OF LEADS.
- B. DIMENSIONS ARE IN MILLIMETERS.
- C. DIMENSIONS AND TOLERANCES PER ASME Y14.5M, 2009
- D. DIMENSIONS ARE EXCLUSIVE OF BURRS, MOLD FLASH AND TIE BAR EXTRUSIONS.
- E. DRAWING FILE NAME: MKT-NA07Drev1

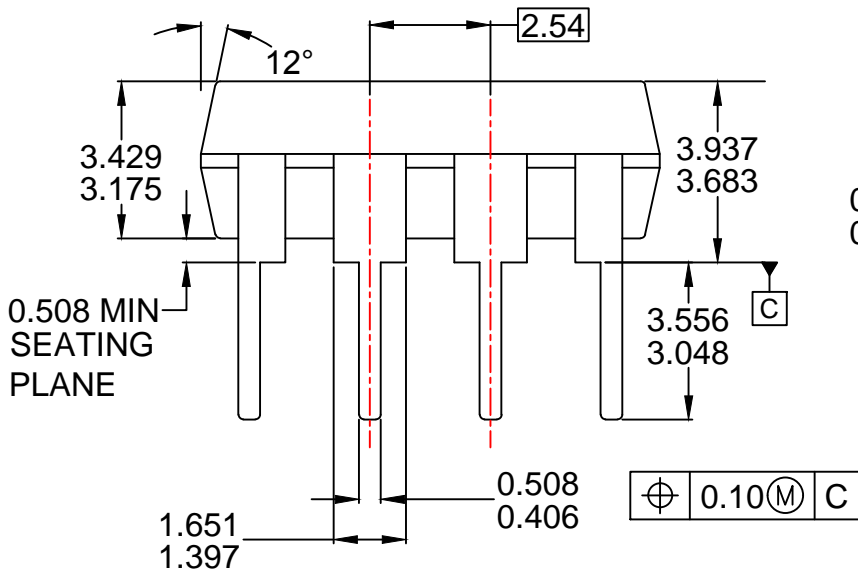

FRONT VIEW

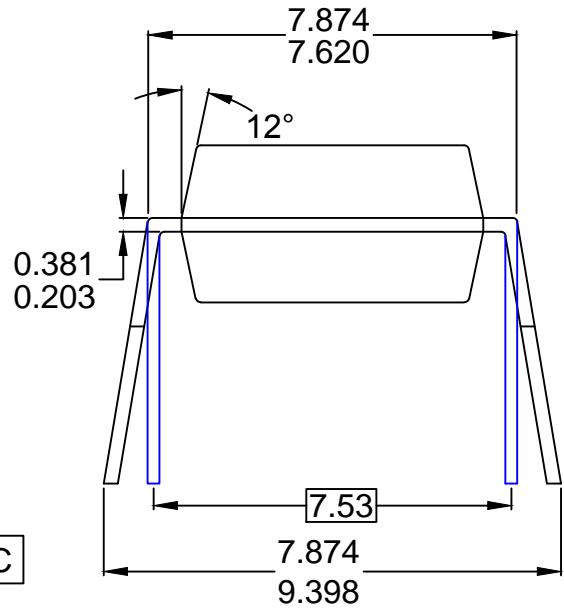

SIDE VIEW

THIS DRAWING IS THE PROPERTY OF FAIRCHILD SEMICONDUCTOR CORPORATION. NO USE THEREOF SHALL BE MADE OTHER THAN AS A REFERENCE FOR PROPOSALS AS SUBMITTED TO FAIRCHILD SEMICONDUCTOR CORPORATION FOR USE IN THE DESIGN OF EQUIPMENT WITH SUCH PROPOSALS UNLESS THE CONSENT OF SAID FAIRCHILD SEMICONDUCTOR CORPORATION HAS PREVIOUSLY BEEN OBTAINED. NO PART OF THIS DRAWING SHALL BE COPIED OR REPRODUCED OR ITS CONTENTS DISCLOSED. THE INFORMATION CONTAINED ON THIS DRAWING IS CONFIDENTIAL AND PROPRIETARY.

REVISIONS			
LTR	DESCRIPTION	E.C.N.	DATE
A	RELEASE TO DOCUMENT CONTROL	-	05APR2004

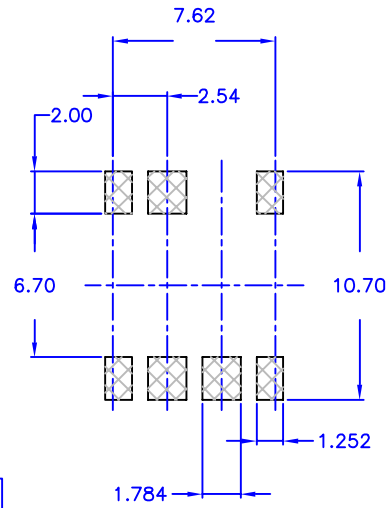
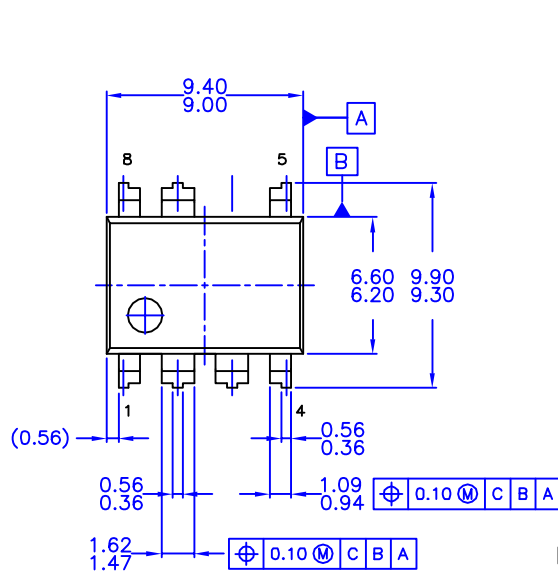

LAND PATTERN RECOMMENDATION

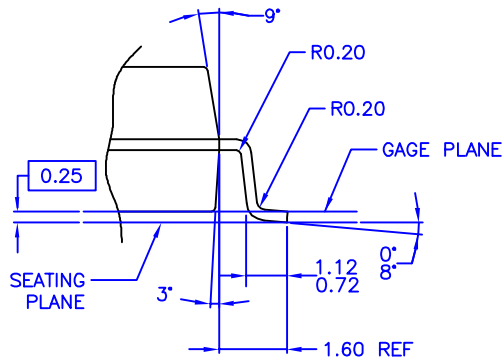
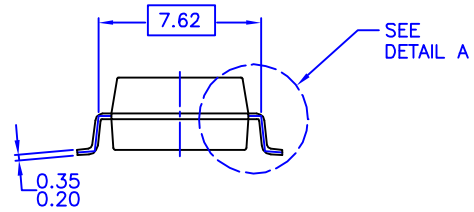
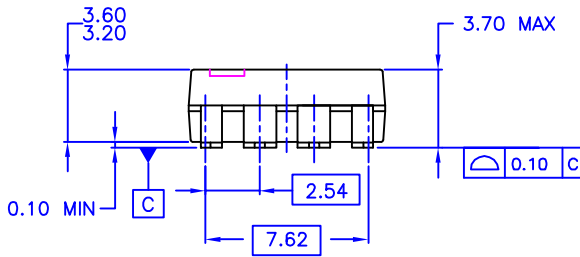

DETAIL A
SCALE: 2X

MKT-MLSOP07ArevA





- NOTES: UNLESS OTHERWISE SPECIFIED
- A) THIS PACKAGE DOES NOT CONFORM TO ANY CURRENT PACKAGE STANDARD
 - B) ALL DIMENSIONS ARE IN MILLIMETERS.
 - C) DIMENSIONS ARE EXCLUSIVE OF BURRS, MOLD FLASH, AND TIE BAR EXTRUSIONS.
 - D) DIMENSIONS AND TOLERANCES PER ASME Y14.5M-1994

APPROVALS		DATE	FAIRCHILD SEMICONDUCTOR™	BUCHeon KOREA	
DRAWN: S. W LIM	CHECKED: S. W LIM	05APR2004			7LD,LSOP, .300" WIDE, SURFACE MOUNT
APPROVED: M.K JONG					
O.S JEON					
PROJECTION		SCALE 1:1	SIZE NA	DRAWING NUMBER MKT-MLSOP07A	REV A
FORMERLY: N/A		SHEET : 1 OF 1			



TRADEMARKS

The following includes registered and unregistered trademarks and service marks, owned by Fairchild Semiconductor and/or its global subsidiaries, and is not intended to be an exhaustive list of all such trademarks.

- | | | | |
|---|--|---|---|
| AccuPower™ | F-PFS™ | OPTOPLANAR® |  |
| AttitudeEngine™ | FRFET® |  | TinyBoost® |
| Awinda® | Global Power Resource™ | PowerTrench® | TinyBuck® |
| AX-CAP®* | GreenBridge™ | PowerXS™ | TinyCalc™ |
| BitSiC™ | Green FPS™ | Programmable Active Droop™ | TinyLogic® |
| Build it Now™ | Green FPS™ e-Series™ | QFET® | TINYOPTO™ |
| CorePLUS™ | Gmax™ | QS™ | TinyPower™ |
| CorePOWER™ | GTO™ | Quiet Series™ | TinyPWM™ |
| CROSSVOLT™ | IntelliMAX™ | RapidConfigure™ | TinyWire™ |
| CTL™ | ISOPLANAR™ |  | TranSiC™ |
| Current Transfer Logic™ | Making Small Speakers Sound Louder and Better™ | Saving our world, 1mW/W/kW at a time™ | TriFault Detect™ |
| DEUXPEED® | MegaBuck™ | SignalWise™ | TRUECURRENT®* |
| Dual Cool™ | MICROCOUPLER™ | SmartMax™ | μSerDes™ |
| EcoSPARK® | MicroFET™ | SMART START™ |  |
| EfficientMax™ | MicroPak™ | Solutions for Your Success™ | UHC® |
| ESBC™ | MicroPak2™ | SPM® | Ultra FRFET™ |
|  | MillerDrive™ | STEALTH™ | UniFET™ |
| Fairchild® | MotionMax™ | SuperFET® | Vcx™ |
| Fairchild Semiconductor® | MotionGrid® | SuperSOT™-3 | VisualMax™ |
| FACT Quiet Series™ | MTI® | SuperSOT™-6 | VoltagePlus™ |
| FACT® | MTX® | SuperSOT™-8 | XST™ |
| FAST® | MVN® | SupreMOS® | Xsens™ |
| FastvCore™ | mWSaver® | SyncFET™ | 仙童™ |
| FETBench™ | OptoHiT™ | Sync-Lock™ | |
| FPS™ | OPTOLOGIC® | | |

* Trademarks of System General Corporation, used under license by Fairchild Semiconductor.

DISCLAIMER

FAIRCHILD SEMICONDUCTOR RESERVES THE RIGHT TO MAKE CHANGES WITHOUT FURTHER NOTICE TO ANY PRODUCTS HEREIN TO IMPROVE RELIABILITY, FUNCTION, OR DESIGN. TO OBTAIN THE LATEST, MOST UP-TO-DATE DATASHEET AND PRODUCT INFORMATION, VISIT OUR WEBSITE AT [HTTP://WWW.FAIRCHILDSEMI.COM](http://www.fairchildsemi.com). FAIRCHILD DOES NOT ASSUME ANY LIABILITY ARISING OUT OF THE APPLICATION OR USE OF ANY PRODUCT OR CIRCUIT DESCRIBED HEREIN; NEITHER DOES IT CONVEY ANY LICENSE UNDER ITS PATENT RIGHTS, NOR THE RIGHTS OF OTHERS. THESE SPECIFICATIONS DO NOT EXPAND THE TERMS OF FAIRCHILD'S WORLDWIDE TERMS AND CONDITIONS, SPECIFICALLY THE WARRANTY THEREIN, WHICH COVERS THESE PRODUCTS.

LIFE SUPPORT POLICY

FAIRCHILD'S PRODUCTS ARE NOT AUTHORIZED FOR USE AS CRITICAL COMPONENTS IN LIFE SUPPORT DEVICES OR SYSTEMS WITHOUT THE EXPRESS WRITTEN APPROVAL OF FAIRCHILD SEMICONDUCTOR CORPORATION.

As used herein:

1. Life support devices or systems are devices or systems which, (a) are intended for surgical implant into the body or (b) support or sustain life, and (c) whose failure to perform when properly used in accordance with instructions for use provided in the labeling, can be reasonably expected to result in a significant injury of the user.
2. A critical component in any component of a life support, device, or system whose failure to perform can be reasonably expected to cause the failure of the life support device or system, or to affect its safety or effectiveness.

ANTI-COUNTERFEITING POLICY

Fairchild Semiconductor Corporation's Anti-Counterfeiting Policy. Fairchild's Anti-Counterfeiting Policy is also stated on our external website, www.fairchildsemi.com, under Sales Support.

Counterfeiting of semiconductor parts is a growing problem in the industry. All manufacturers of semiconductor products are experiencing counterfeiting of their parts. Customers who inadvertently purchase counterfeit parts experience many problems such as loss of brand reputation, substandard performance, failed applications, and increased cost of production and manufacturing delays. Fairchild is taking strong measures to protect ourselves and our customers from the proliferation of counterfeit parts. Fairchild strongly encourages customers to purchase Fairchild parts either directly from Fairchild or from Authorized Fairchild Distributors who are listed by country on our web page cited above. Products customers buy either from Fairchild directly or from Authorized Fairchild Distributors are genuine parts, have full traceability, meet Fairchild's quality standards for handling and storage and provide access to Fairchild's full range of up-to-date technical and product information. Fairchild and our Authorized Distributors will stand behind all warranties and will appropriately address any warranty issues that may arise. Fairchild will not provide any warranty coverage or other assistance for parts bought from Unauthorized Sources. Fairchild is committed to combat this global problem and encourage our customers to do their part in stopping this practice by buying direct or from authorized distributors.

PRODUCT STATUS DEFINITIONS

Definition of Terms

Datasheet Identification	Product Status	Definition
Advance Information	Formative / In Design	Datasheet contains the design specifications for product development. Specifications may change in any manner without notice.
Preliminary	First Production	Datasheet contains preliminary data; supplementary data will be published at a later date. Fairchild Semiconductor reserves the right to make changes at any time without notice to improve design.
No Identification Needed	Full Production	Datasheet contains final specifications. Fairchild Semiconductor reserves the right to make changes at any time without notice to improve the design.
Obsolete	Not In Production	Datasheet contains specifications on a product that is discontinued by Fairchild Semiconductor. The datasheet is for reference information only.

Rev. I73