

## Features

- High speed
  - $t_{AA} = 12 \text{ ns}$
- Low active power
  - $I_{CC} = 300 \text{ mA}$  at 12 ns
- Low complementary metal oxide semiconductor (CMOS) standby power
  - $I_{SB2} = 100 \text{ mA}$
- Operating voltages of  $3.3 \pm 0.3 \text{ V}$
- 2.0-V data retention
- Automatic power-down when deselected
- Transistor-transistor logic (TTL)-compatible inputs and outputs
- Easy memory expansion with  $\overline{CE}_1$  and  $CE_2$  features
- Available in Pb-free 48-ball fine ball grid array (FBGA) package

## Functional Description

The CY7C1089DV33 is a high-performance CMOS static RAM organized as 8,388,608 words by 8 bits.

To write to the device, take Chip Enables ( $\overline{CE}_1$  LOW and  $CE_2$  HIGH) and Write Enable ( $\overline{WE}$ ) input LOW. Data on the eight I/O pins ( $I/O_0$  through  $I/O_7$ ) is then written into the location specified on the address pins ( $A_0$  through  $A_{22}$ ).

To read from the device, take Chip Enables ( $\overline{CE}_1$  LOW and  $CE_2$  HIGH) LOW and Output Enable ( $\overline{OE}$ ) LOW while forcing the Write Enable ( $\overline{WE}$ ) HIGH. Under these conditions, the contents of the memory location specified by the address pins appear on the I/O pins. See [Truth Table on page 9](#) for a complete description of Read and Write modes.

The input and output pins ( $I/O_0$  through  $I/O_7$ ) are placed in a high impedance state when the device is deselected ( $\overline{CE}_1$  LOW or  $CE_2$  HIGH), the outputs are disabled ( $\overline{OE}$  HIGH), or during a write operation ( $\overline{CE}_1$  LOW,  $CE_2$  HIGH and  $\overline{WE}$  LOW).

## Logic Block Diagram

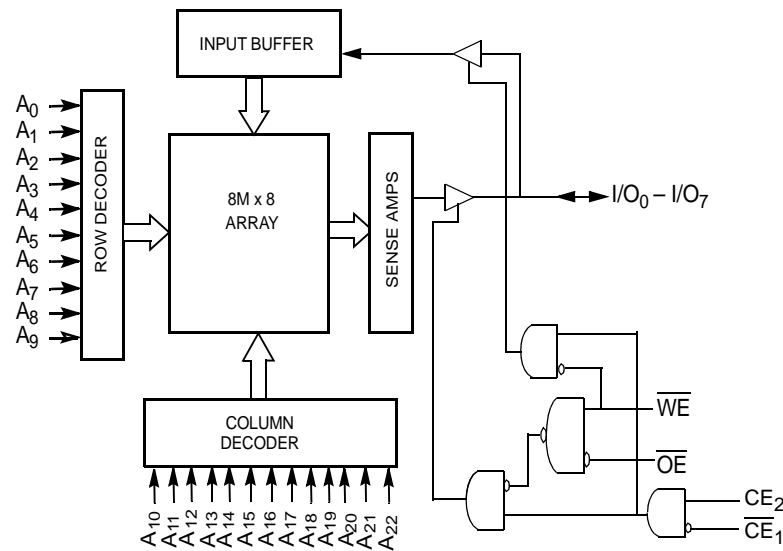

## Selection Guide

Description	-12	Unit
Maximum access time	12	ns
Maximum operating current	300	mA
Maximum CMOS standby current	100	mA

## Contents

<b>Pin Configuration</b> .....	<b>3</b>	<b>Package Diagram</b> .....	<b>10</b>
<b>Maximum Ratings</b> .....	<b>4</b>	<b>Acronyms</b> .....	<b>10</b>
<b>Operating Range</b> .....	<b>4</b>	<b>Document Conventions</b> .....	<b>10</b>
<b>DC Electrical Characteristics</b> .....	<b>4</b>	Units of Measure .....	10
<b>Capacitance</b> .....	<b>4</b>	<b>Document History Page</b> .....	<b>11</b>
<b>Thermal Resistance</b> .....	<b>4</b>	<b>Sales, Solutions, and Legal Information</b> .....	<b>11</b>
<b>Data Retention Characteristics</b> .....	<b>5</b>	Worldwide Sales and Design Support .....	11
<b>AC Switching Characteristics</b> .....	<b>6</b>	Products .....	11
<b>Switching Waveforms</b> .....	<b>7</b>	PSoC Solutions .....	11
<b>Truth Table</b> .....	<b>9</b>		
<b>Ordering Information</b> .....	<b>9</b>		
Ordering Code Definition .....	9		

## Pin Configuration

Figure 1. 48-Ball FBGA (Top View) <sup>[1]</sup>

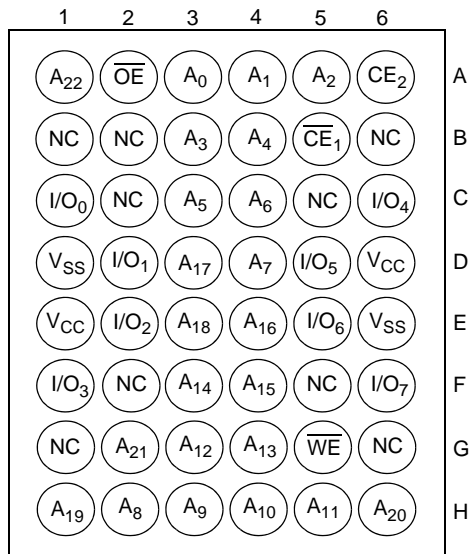

**Note**

1. NC pins are not connected to the die.

## Maximum Ratings

Exceeding maximum ratings may shorten the useful life of the device. These user guidelines are not tested.

Storage temperature ..... -65 °C to +150 °C

Ambient temperature with power applied ..... -55 °C to +125 °C

Supply voltage on  $V_{CC}$  relative to GND<sup>[2]</sup> ..... -0.5 V to +4.6 V

DC voltage applied to outputs in high-Z state<sup>[2]</sup> ..... -0.5 V to  $V_{CC} + 0.5$  V

DC input voltage<sup>[2]</sup> ..... -0.5 V to  $V_{CC} + 0.5$  V

Current into outputs (LOW) ..... 20 mA

Static discharge voltage..... >2001 V

(MIL-STD-883, Method 3015)

Latch up current..... >140 mA

## Operating Range

Range	Ambient Temperature	$V_{CC}$
Industrial	-40 °C to +85 °C	3.3V ± 0.3V

## DC Electrical Characteristics

Over the Operating Range

Parameter	Description	Test Conditions	-12		Unit
			Min	Max	
$V_{OH}$	Output HIGH voltage	$V_{CC} = \text{Min}, I_{OH} = -4.0 \text{ mA}$	2.4	-	V
$V_{OL}$	Output LOW voltage	$V_{CC} = \text{Min}, I_{OL} = 8.0 \text{ mA}$	-	0.4	V
$V_{IH}$	Input HIGH voltage		2.0	$V_{CC} + 0.3$	V
$V_{IL}$	Input LOW voltage <sup>[2]</sup>		-0.3	0.8	V
$I_{IX}$	Input leakage current	$GND \leq V_{IN} \leq V_{CC}$	-1	+1	μA
$I_{OZ}$	Output leakage current	$GND \leq V_{OUT} \leq V_{CC}$ , Output disabled	-1	+1	μA
$I_{CC}$	$V_{CC}$ operating supply current	$V_{CC} = \text{Max}, f = f_{MAX} = 1/t_{RC}, I_{OUT} = 0 \text{ mA CMOS levels}$	-	300	mA
$I_{SB1}$	Automatic CE power-down current — TTL inputs	Max $V_{CC}$ , $\overline{CE}_1 \geq V_{IH}$ , $CE_2 \leq V_{IL}$ , $V_{IN} \geq V_{IH}$ or $V_{IN} \leq V_{IL}$ , $f = f_{MAX}$	-	120	mA
$I_{SB2}$	Automatic CE power-down current — CMOS inputs	Max $V_{CC}$ , $\overline{CE}_1 \geq V_{CC} - 0.3V$ , $CE_2 \leq 0.3V$ , $V_{IN} \geq V_{CC} - 0.3V$ , or $V_{IN} \leq 0.3V$ , $f = 0$	-	100	mA

## Capacitance

Tested initially and after any design or process changes that may affect these parameters.

Parameter	Description	Test Conditions	FBGA	Unit
$C_{IN}$	Input capacitance	$T_A = 25 \text{ °C}, f = 1 \text{ MHz}, V_{CC} = 3.3 \text{ V}$	32	pF
$C_{OUT}$	I/O capacitance		40	pF

## Thermal Resistance

Tested initially and after any design or process changes that may affect these parameters.

Parameter	Description	Test Conditions	FBGA	Unit
$\theta_{JA}$	Thermal resistance (junction to ambient)	Still air, soldered on a 3 x 4.5 inch, four layer printed circuit board	55	°C/W
$\theta_{JC}$	Thermal resistance (junction to case)		23.04	°C/W

### Note

2.  $V_{IL}(\text{min}) = -2.0V$  and  $V_{IH}(\text{max}) = V_{CC} + 2V$  for pulse durations of less than 20 ns.

Figure 2. AC Test Loads and Waveforms<sup>[3]</sup>

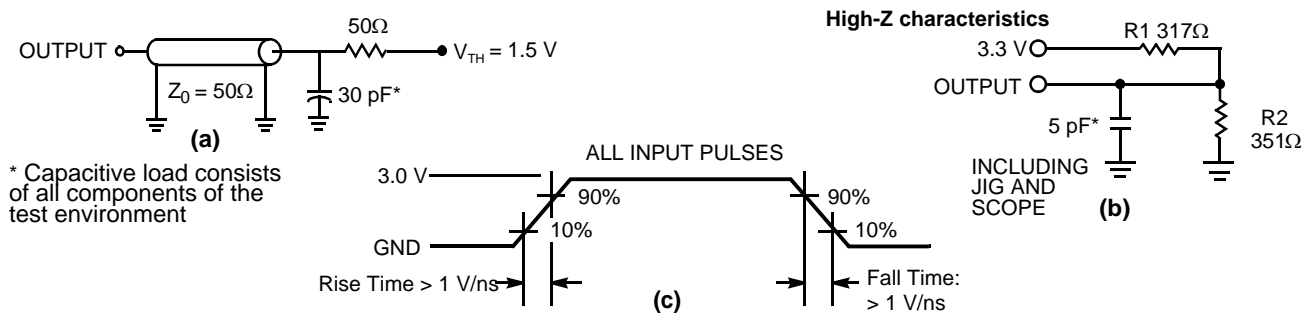

## Data Retention Characteristics

Over the Operating Range

Parameter	Description	Conditions	Min	Typ	Max	Unit
$V_{DR}$	$V_{CC}$ for data retention		2	–	–	V
$I_{CCDR}$	Data retention current	$V_{CC} = 2\text{ V}$ , $CE_1 \geq V_{CC} - 0.2\text{ V}$ , $CE_2 \leq 0.2\text{ V}$ , $V_{IN} \geq V_{CC} - 0.2\text{ V}$ or $V_{IN} \leq 0.2\text{ V}$	–	–	100	mA
$t_{CDR}^{[4]}$	Chip deselect to data retention time		0	–	–	ns
$t_R^{[5]}$	Operation recovery time		12	–	–	ns

Figure 3. Data Retention Waveform

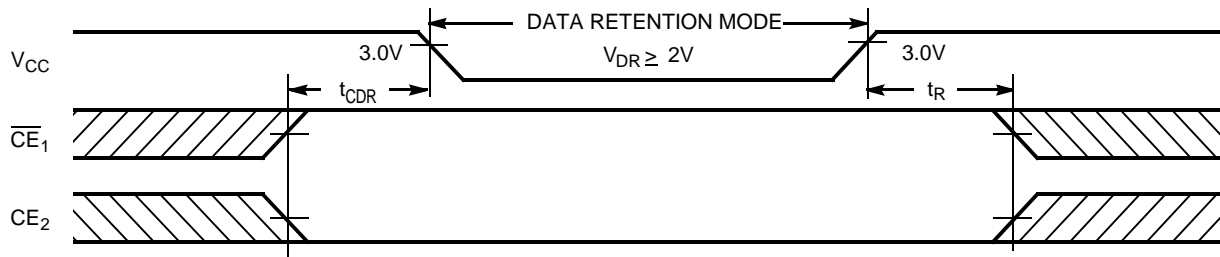

### Notes

- Valid SRAM operation does not occur until the power supplies have reached the minimum operating  $V_{DD}$  (3.0V). 100  $\mu\text{s}$  ( $t_{power}$ ) after reaching the minimum operating  $V_{DD}$ , normal SRAM operation begins including reduction in  $V_{DD}$  to the data retention ( $V_{CCDR}$ , 2.0V) voltage.
- Tested initially and after any design or process changes that may affect these parameters.
- Full device operation requires linear  $V_{CC}$  ramp from  $V_{DR}$  to  $V_{CC(min.)} \geq 50\ \mu\text{s}$  or stable at  $V_{CC(min.)} \geq 50\ \mu\text{s}$ .

## AC Switching Characteristics

Over the Operating Range <sup>[6]</sup>

Parameter	Description	-12		Unit
		Min	Max	
<b>Read Cycle</b>				
$t_{power}$	$V_{CC}$ (typical) to the first access <sup>[7]</sup>	100	–	$\mu$ s
$t_{RC}$	Read cycle time	12	–	ns
$t_{AA}$	Address to data valid	–	12	ns
$t_{OHA}$	Data hold from address change	3	–	ns
$t_{ACE}$	$\overline{CE}_1$ LOW and $CE_2$ HIGH to data valid	–	12	ns
$t_{DOE}$	$\overline{OE}$ LOW to data valid	–	7	ns
$t_{LZOE}$	$\overline{OE}$ LOW to low-Z	1	–	ns
$t_{HZOE}$	$\overline{OE}$ HIGH to high-Z <sup>[8]</sup>	–	7	ns
$t_{LZCE}$	$\overline{CE}_1$ LOW and $CE_2$ HIGH to low-Z <sup>[8]</sup>	3	–	ns
$t_{HZCE}$	$\overline{CE}_1$ HIGH and $CE_2$ LOW to high-Z <sup>[8]</sup>	–	7	ns
$t_{PU}$	$\overline{CE}_1$ LOW and $CE_2$ HIGH to power-up <sup>[9]</sup>	0	–	ns
$t_{PD}$	$\overline{CE}_1$ HIGH and $CE_2$ LOW to power-down <sup>[9]</sup>	–	12	ns
<b>Write Cycle</b> <sup>[10, 11]</sup>				
$t_{WC}$	Write cycle time	12	–	ns
$t_{SCE}$	$\overline{CE}_1$ LOW and $CE_2$ HIGH to write end	9	–	ns
$t_{AW}$	Address setup to write end	9	–	ns
$t_{HA}$	Address hold from write end	0	–	ns
$t_{SA}$	Address setup to write start	0	–	ns
$t_{PWE}$	$\overline{WE}$ pulse width	9	–	ns
$t_{SD}$	Data setup to write end	7	–	ns
$t_{HD}$	Data hold from write end	0	–	ns
$t_{LZWE}$	$\overline{WE}$ HIGH to low-Z <sup>[8]</sup>	3	–	ns
$t_{HZWE}$	$\overline{WE}$ LOW to high-Z <sup>[8]</sup>	–	7	ns

### Notes

- Test conditions assume signal transition time of 3 ns or less, timing reference levels of 1.5V, and input pulse levels of 0 to 3.0V. Test conditions for the read cycle use output loading shown in part a) of [AC Test Loads and Waveforms](#)[3], unless specified otherwise.
- $t_{POWER}$  gives the minimum amount of time that the power supply is at typical  $V_{CC}$  values until the first memory access is performed.
- $t_{HZOE}$ ,  $t_{HZCE}$ ,  $t_{HZWE}$ ,  $t_{LZOE}$ ,  $t_{LZCE}$ , and  $t_{LZWE}$  are specified with a load capacitance of 5 pF as in (b) of [AC Test Loads and Waveforms](#)[3].
- These parameters are guaranteed by design and are not tested.
- The internal write time of the memory is defined by the overlap of  $\overline{WE}$ ,  $\overline{CE}_1 = V_{IL}$ , and  $CE_2 = V_{IH}$ . Chip enables must be active and  $\overline{WE}$  must be LOW to initiate a write, and the transition of any of these signals can terminate. The input data setup and hold timing should be referenced to the edge of the signal that terminates the write.
- The minimum write cycle time for Write Cycle No. 2 ( $\overline{WE}$  controlled,  $\overline{OE}$  LOW) is the sum of  $t_{HZWE}$  and  $t_{SD}$ .

### Switching Waveforms

Figure 4. Read Cycle No. 1 [12, 13, 14]

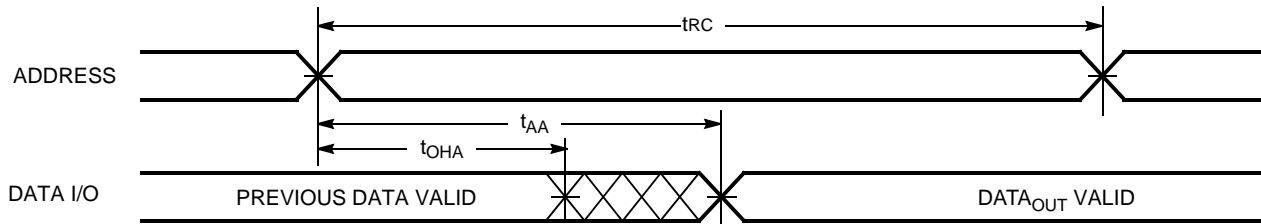
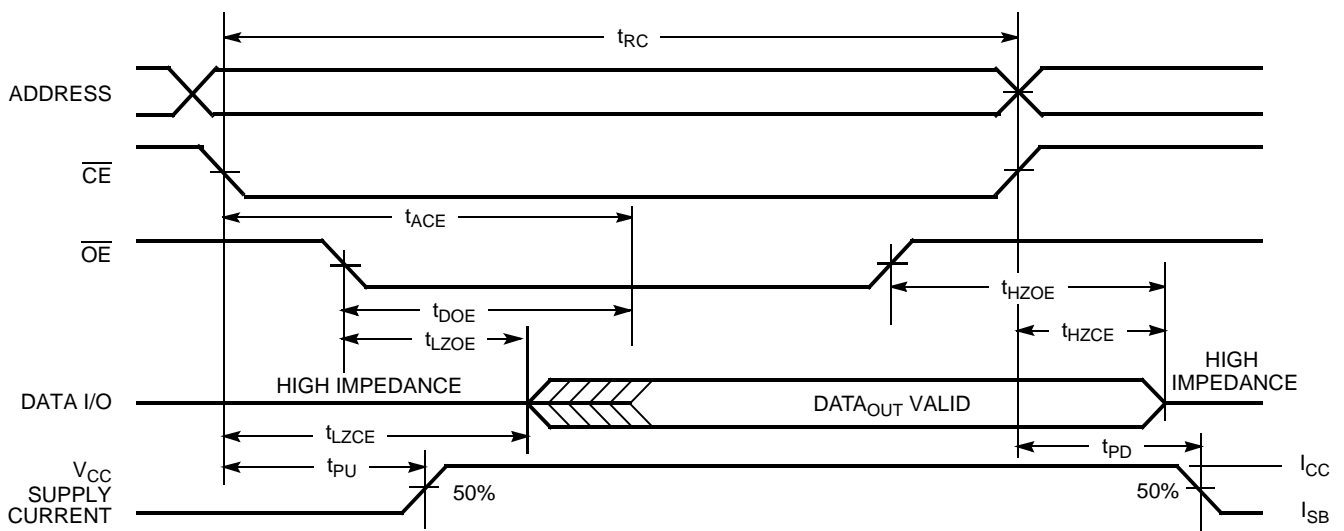

Figure 5. Read Cycle No. 2 ( $\overline{OE}$  Controlled) [12, 14, 15]



**Notes**

- 12.  $\overline{CE}$  refers to the internal logical combination of  $\overline{CE}_1$  and  $CE_2$  such that when  $\overline{CE}_1$  is LOW and  $CE_2$  is HIGH,  $\overline{CE}$  is LOW. For all other combinations,  $\overline{CE}$  is HIGH.
- 13. The device is continuously selected.  $\overline{CE} = V_{IL}$ .
- 14.  $\overline{WE}$  is HIGH for read cycle.
- 15. Address valid before or similar to  $\overline{CE}$  transition LOW.

Switching Waveforms (continued)

Figure 6. Write Cycle No. 1 ( $\overline{CE}$  Controlled) [16, 17, 18]

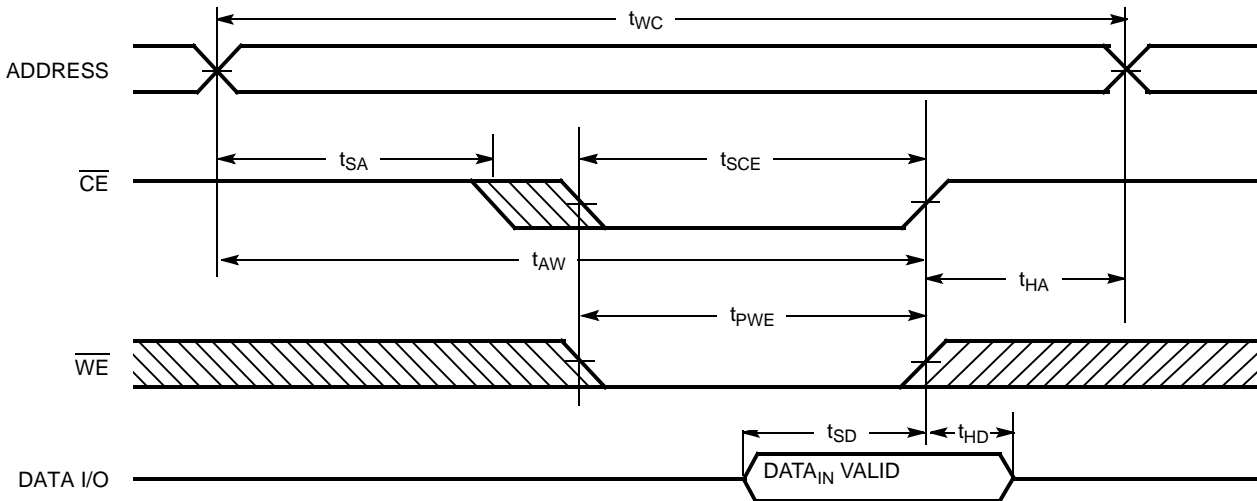
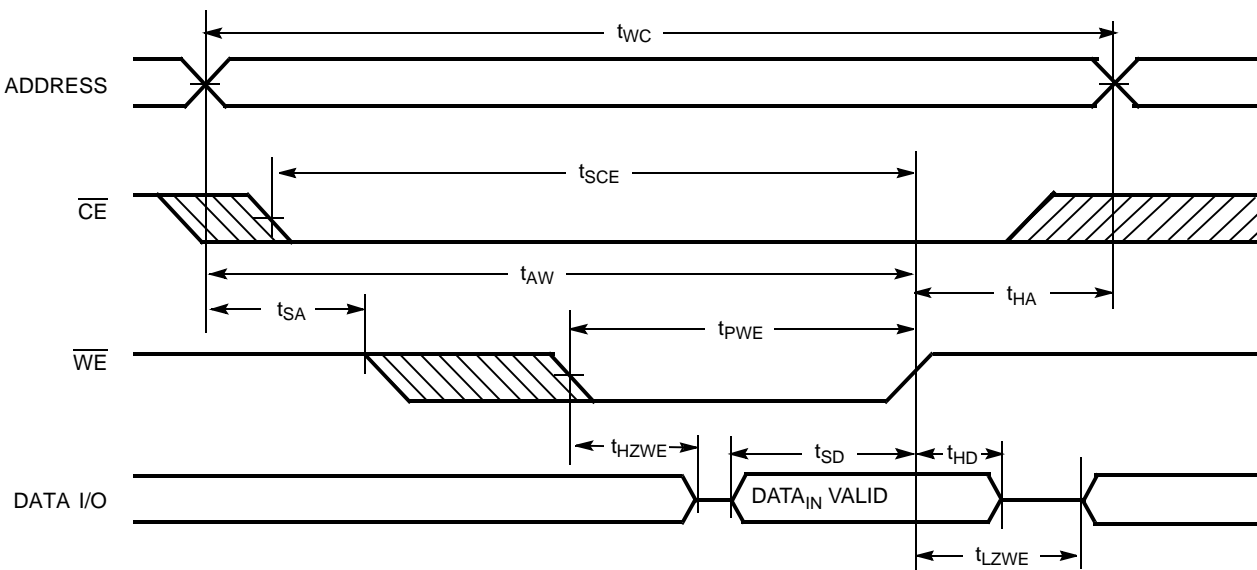

Figure 7. Write Cycle No. 2 ( $\overline{WE}$  Controlled,  $\overline{OE}$  LOW) [16, 17, 18]



Notes

- 16.  $\overline{CE}$  refers to the internal logical combination of  $\overline{CE}_1$  and  $CE_2$  such that when  $\overline{CE}_1$  is LOW and  $CE_2$  is HIGH,  $\overline{CE}$  is LOW. For all other combinations,  $\overline{CE}$  is HIGH.
- 17. Data I/O is high impedance if  $\overline{OE} = V_{IH}$ .
- 18. If  $\overline{CE}$  goes HIGH simultaneously with  $\overline{WE}$  going HIGH, the output remains in a high impedance state.



**Truth Table**

$\overline{CE}_1$	$\overline{CE}_2$	$\overline{OE}$	$\overline{WE}$	I/O <sub>0</sub> – I/O <sub>7</sub>	Mode	Power
H	X	X	X	High-Z	Power down	Standby (I <sub>SB</sub> )
X	L	X	X	High-Z	Power down	Standby (I <sub>SB</sub> )
L	H	L	H	Data Out	Read all bits	Active (I <sub>CC</sub> )
L	H	X	L	Data In	Write all bits	Active (I <sub>CC</sub> )
L	H	H	H	High-Z	Selected, Outputs disabled	Active (I <sub>CC</sub> )

**Ordering Information**

Speed (ns)	Ordering Code	Package Diagram	Package Type	Operating Range
12	CY7C1089DV33-12BAXI	001-50044	48-ball FBGA (8 x 9.5 x 1.4 mm) (Pb-free)	Industrial

**Ordering Code Definition**

CY 7 C 1 08 9 D V33 - xx xxx x

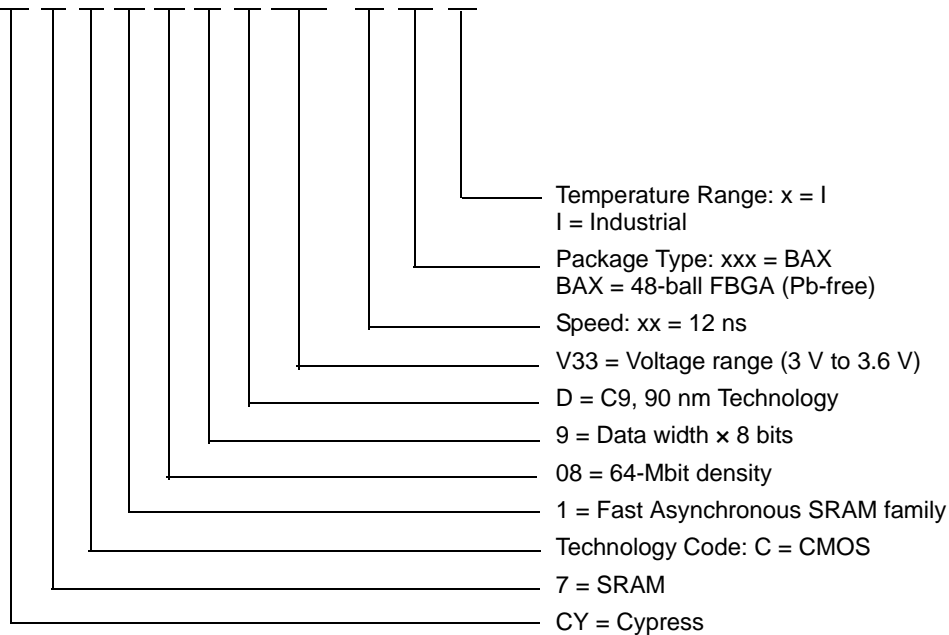

Package Diagram

Figure 8. 48-Ball FBGA (8 x 9.5 x 1.4 mm) (001-50044)

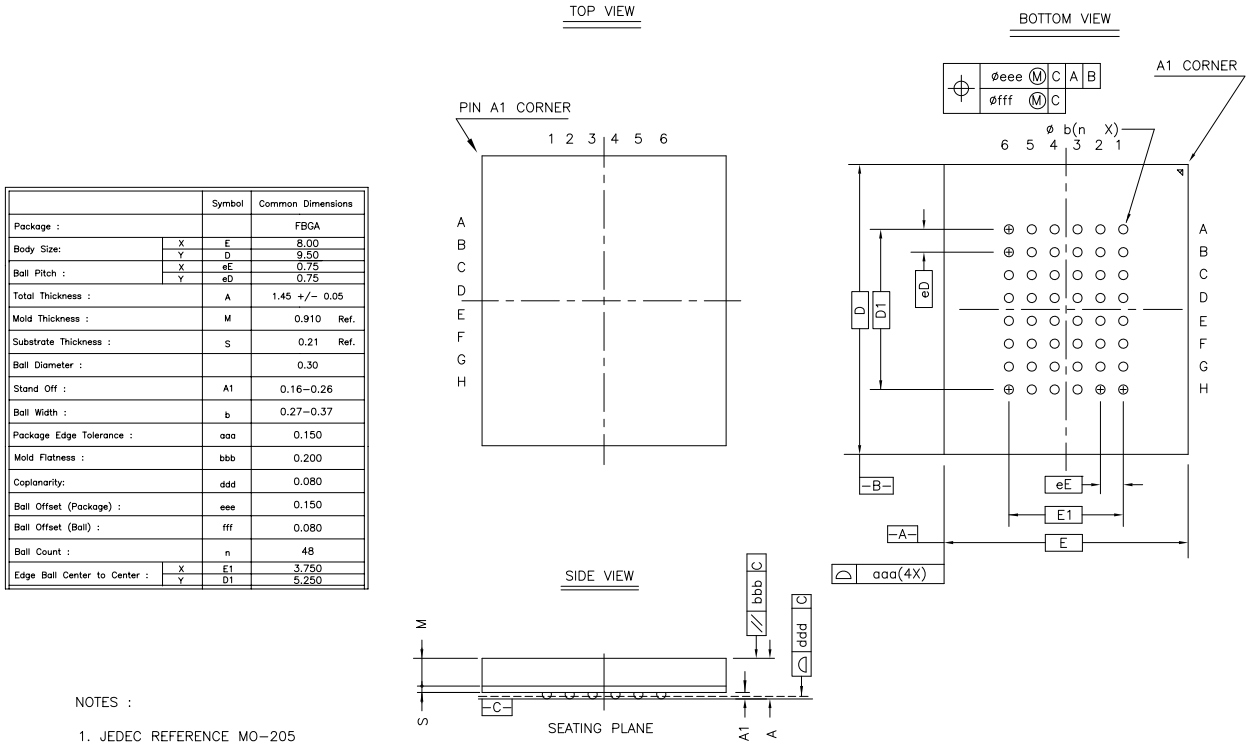

- NOTES :
1. JEDEC REFERENCE MO-205
  2. PACKAGE WEIGHT : 0.2409g
  3. DIMENSIONS IN MILLIMETERS

001-50044 \*C

Acronyms

Acronym	Description
CMOS	complementary metal oxide semiconductor
FBGA	fine ball grid array
I/O	input/output
SRAM	static random access memory
TTL	transistor-transistor logic

Document Conventions

Units of Measure

Symbol	Unit of Measure
°C	degrees Celsius
µA	microampere
mA	milliampere
MHz	megahertz
ns	nanosecond
pF	picofarad
V	volt
Ω	ohm
W	watt

## Document History Page

Document Title: CY7C1089DV33, 64-Mbit (8 M × 8) Static RAM					
Document Number: 001-53993					
Revision	ECN	Submission Date	Orig. of Change	Description of Change	
**	2746867	07/31/2009	VKN/AESA	New Data sheet	
*A	3100499	12/02/2010	PRAS	Updated Note 12. Changed datasheet status from Preliminary to Final. Updated <a href="#">Package Diagram</a> and <a href="#">Sales, Solutions, and Legal Information</a> . Added <a href="#">Acronyms</a> , <a href="#">Document Conventions</a> and <a href="#">Ordering Code Definition</a> .	
*B	3178259	21/02/2011	PRAS	Post to external web.	
*C	3720118	08/22/2012	TAVA	Minor Text edits.	

## Sales, Solutions, and Legal Information

### Worldwide Sales and Design Support

Cypress maintains a worldwide network of offices, solution centers, manufacturer's representatives, and distributors. To find the office closest to you, visit us at [Cypress Locations](#).

### Products

Automotive	<a href="http://cypress.com/go/automotive">cypress.com/go/automotive</a>
Clocks & Buffers	<a href="http://cypress.com/go/clocks">cypress.com/go/clocks</a>
Interface	<a href="http://cypress.com/go/interface">cypress.com/go/interface</a>
Lighting & Power Control	<a href="http://cypress.com/go/powerpsoc">cypress.com/go/powerpsoc</a> <a href="http://cypress.com/go/plc">cypress.com/go/plc</a>
Memory	<a href="http://cypress.com/go/memory">cypress.com/go/memory</a>
Optical & Image Sensing	<a href="http://cypress.com/go/image">cypress.com/go/image</a>
PSoC	<a href="http://cypress.com/go/psoc">cypress.com/go/psoc</a>
Touch Sensing	<a href="http://cypress.com/go/touch">cypress.com/go/touch</a>
USB Controllers	<a href="http://cypress.com/go/USB">cypress.com/go/USB</a>
Wireless/RF	<a href="http://cypress.com/go/wireless">cypress.com/go/wireless</a>

### PSoC Solutions

[psoc.cypress.com/solutions](http://psoc.cypress.com/solutions)  
[PSoC 1](#) | [PSoC 3](#) | [PSoC 5](#)

© Cypress Semiconductor Corporation, 2009-2012. The information contained herein is subject to change without notice. Cypress Semiconductor Corporation assumes no responsibility for the use of any circuitry other than circuitry embodied in a Cypress product. Nor does it convey or imply any license under patent or other rights. Cypress products are not warranted nor intended to be used for medical, life support, life saving, critical control or safety applications, unless pursuant to an express written agreement with Cypress. Furthermore, Cypress does not authorize its products for use as critical components in life-support systems where a malfunction or failure may reasonably be expected to result in significant injury to the user. The inclusion of Cypress products in life-support systems application implies that the manufacturer assumes all risk of such use and in doing so indemnifies Cypress against all charges.

Any Source Code (software and/or firmware) is owned by Cypress Semiconductor Corporation (Cypress) and is protected by and subject to worldwide patent protection (United States and foreign), United States copyright laws and international treaty provisions. Cypress hereby grants to licensee a personal, non-exclusive, non-transferable license to copy, use, modify, create derivative works of, and compile the Cypress Source Code and derivative works for the sole purpose of creating custom software and/or firmware in support of licensee product to be used only in conjunction with a Cypress integrated circuit as specified in the applicable agreement. Any reproduction, modification, translation, compilation, or representation of this Source Code except as specified above is prohibited without the express written permission of Cypress.

Disclaimer: CYPRESS MAKES NO WARRANTY OF ANY KIND, EXPRESS OR IMPLIED, WITH REGARD TO THIS MATERIAL, INCLUDING, BUT NOT LIMITED TO, THE IMPLIED WARRANTIES OF MERCHANTABILITY AND FITNESS FOR A PARTICULAR PURPOSE. Cypress reserves the right to make changes without further notice to the materials described herein. Cypress does not assume any liability arising out of the application or use of any product or circuit described herein. Cypress does not authorize its products for use as critical components in life-support systems where a malfunction or failure may reasonably be expected to result in significant injury to the user. The inclusion of Cypress' product in a life-support systems application implies that the manufacturer assumes all risk of such use and in doing so indemnifies Cypress against all charges.

Use may be limited by and subject to the applicable Cypress software license agreement.