

### **Rochester Electronics Manufactured Components**

Rochester branded components are manufactured using either die/wafers purchased from the original suppliers or Rochester wafers recreated from the original IP. All recreations are done with the approval of the OCM.

Parts are tested using original factory test programs or Rochester developed test solutions to guarantee product meets or exceed the OCM data sheet.

### **Quality Overview**

- ISO-9001
- AS9120 certification
- Qualified Manufacturers List (QML) MIL-PRF-35835
  - Class Q Military
  - Class V Space Level
- Qualified Suppliers List of Distributors (QSLD)
  - Rochester is a critical supplier to DLA and meets all industry and DLA standards.

Rochester Electronics, LLC is committed to supplying products that satisfy customer expectations for quality and are equal to those originally supplied by industry manufacturers.

The original manufacturer's datasheet accompanying this document reflects the performance and specifications of the Rochester manufactured version of this device. Rochester Electronics guarantees the performance of its semiconductor products to the original OEM specifications. 'Typical' values are for reference purposes only. Certain minimum or maximum ratings may be based on product characterization, design, simulation, or sample testing.

# SN65551, SN65552, SN75551, SN75552 ELECTROLUMINESCENT ROW DRIVERS

SLDS023B - D2743, MARCH 1983 - REVISED APRIL 1993

- Each Device Drives 32 Electrodes
- High-Voltage Open-Drain DMOS Outputs
- 50-mA Output Current Capability
- CMOS-Compatible Inputs
- Very Low Steady-State Power Consumption

## description

The SN65551, SN65552, SN75551, and SN75552 are monolithic BIFDETT† integrated circuits designed to drive the row electrodes of an electroluminescent display. All inputs are CMOS compatible and all outputs are high-voltage open-drain DMOS transistors. The SN75552 output sequence is reversed from the SN75551 for ease in printed-circuit-board layout.

The devices consist of a 32-bit shift register, 32 AND gates, and 32 output OR gates. Typically, a composite row drive signal is externally generated by a high-voltage switching circuit and applied to SUBSTRATE COMMON. Serial data is entered into the shift register on the high-to-low transition of CLOCK. A high at ENABLE allows those outputs with a high in their associated register to be turned on causing the corresponding row to be connected to the composite row drive signal.

When STROBE is low, all output transistors are turned on. The serial data output (SERIAL OUT) from the shift register can be used to cascade additional devices. This output is not affected by ENABLE or STROBE.

The SN65551 and SN65552 are characterized for operation from -40°C to 85°C. The SN75551 and SN75552 are characterized for operation from 0°C to 70°C.

## SN65551 . . . N PACKAGE (TOP VIEW)

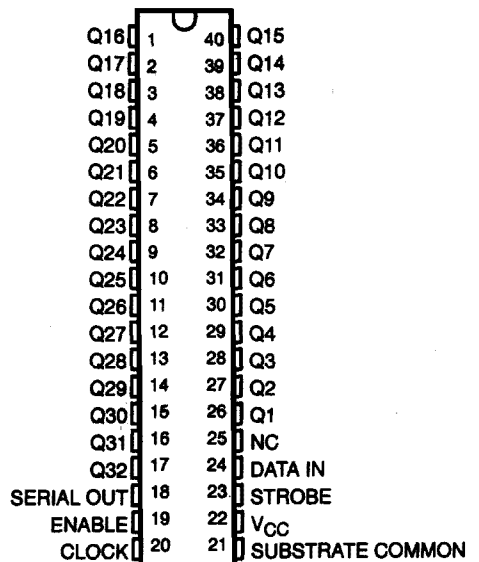

NC - No internal connection

† BIFDETT - Bipolar, double-diffused, N-channel and P-channel MOS transistors on same chip. This is a patented process.

PRODUCTION DATA Information is current as of publication date. Products conform to specifications per the terms of Texas Instruments standard warranty. Production processing does not necessarily include testing of all parameters.

**TEXAS  
INSTRUMENTS**

POST OFFICE BOX 655303 • DALLAS, TEXAS 75286

Copyright © 1993, Texas Instruments Incorporated

# SN65551, SN65552, SN75551, SN75552 ELECTROLUMINESCENT ROW DRIVERS

SLDS023B - D2743, MARCH 1983 - REVISED APRIL 1993

SN65551, SN75551 ... FN PACKAGE  
(TOP VIEW)

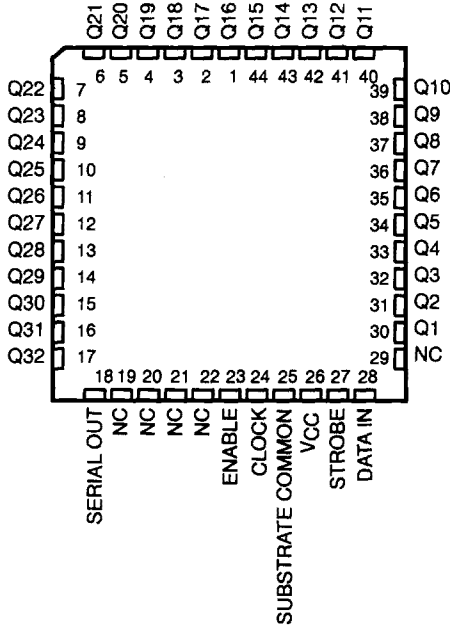

SN65552, SN75552 ... FN PACKAGE  
(TOP VIEW)

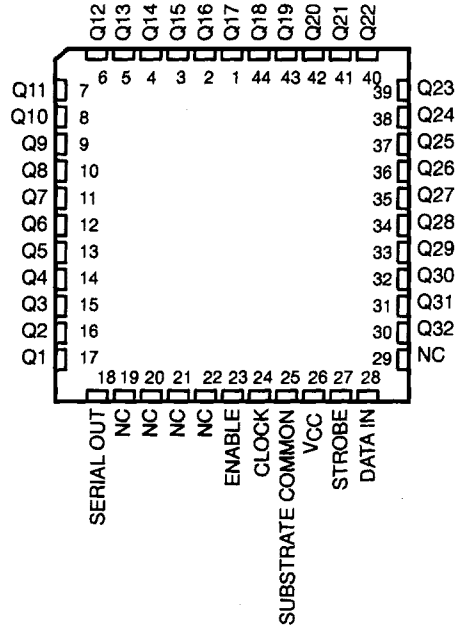

NC - No internal connection

## Logic symbol†

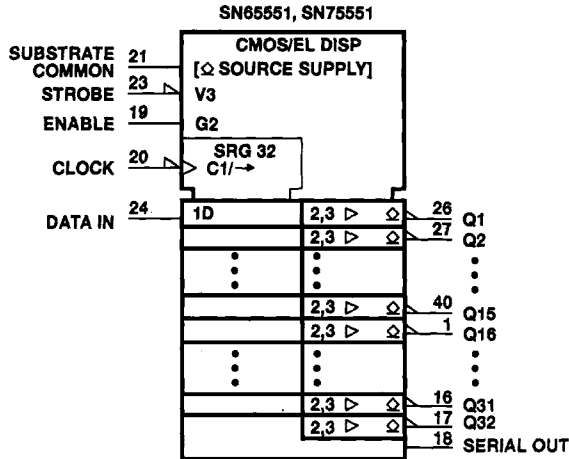

† This symbol is in accordance with ANSI/IEEE Std 91-1984 and IEC Publication 617-12. The symbol  $\Delta$  here indicates an n-channel open-drain output.

Pin numbers shown are for the N package.

# SN65551, SN65552, SN75551, SN75552 ELECTROLUMINESCENT ROW DRIVERS

SLDS023B - D2743, MARCH 1983 - REVISED APRIL 1983

## logic diagram (positive logic)

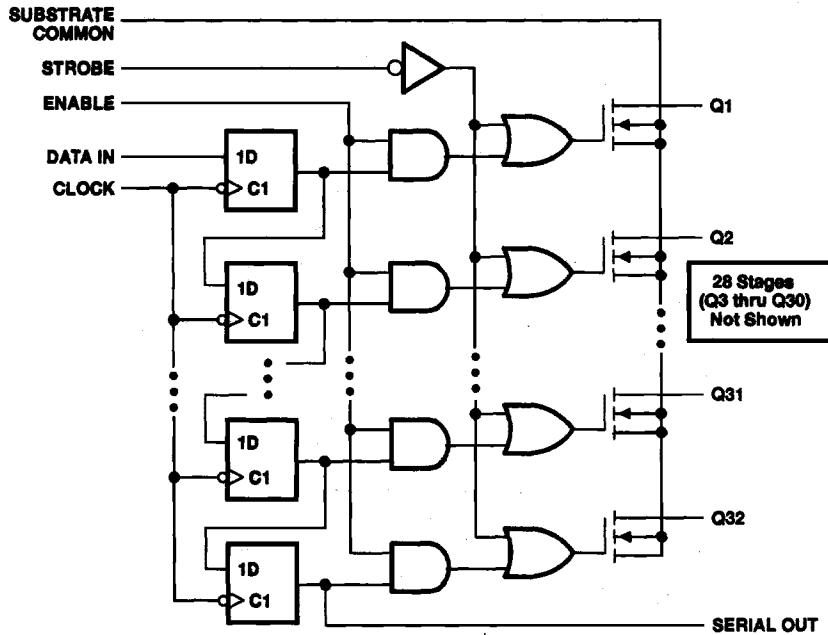

FUNCTION TABLE

FUNCTION	CONTROL INPUTS			SHIFT REGISTERS R1 THRU R32	OUTPUTS	
	CLOCK	ENABLE	STROBE		SERIAL	Q1 THRU Q32
Load	↓	X	X	Load and shift†	R32	Determined by ENABLE and STROBE
	No ↓	X	X	No change	R32	Determined by ENABLE and STROBE
Enable	X	L	H	As determined above	R32	All Q outputs off
	X	H	H	As determined above	R32	Determined by R1 through R32
Strobe	X	X	L	As determined above	R32	All Q outputs on

H = high level, L = low level, X = irrelevant, ↓ = high-to-low transition.

† Register R32 takes on the state of R31, R31 takes on the state of R30, ... R2 takes on the state of R1, and R1 takes on the state of the data input.

# SN65551, SN65552, SN75551, SN75552 ELECTROLUMINESCENT ROW DRIVERS

SLDS023B - D2743, MARCH 1983 - REVISED APRIL 1993

## typical operating sequence

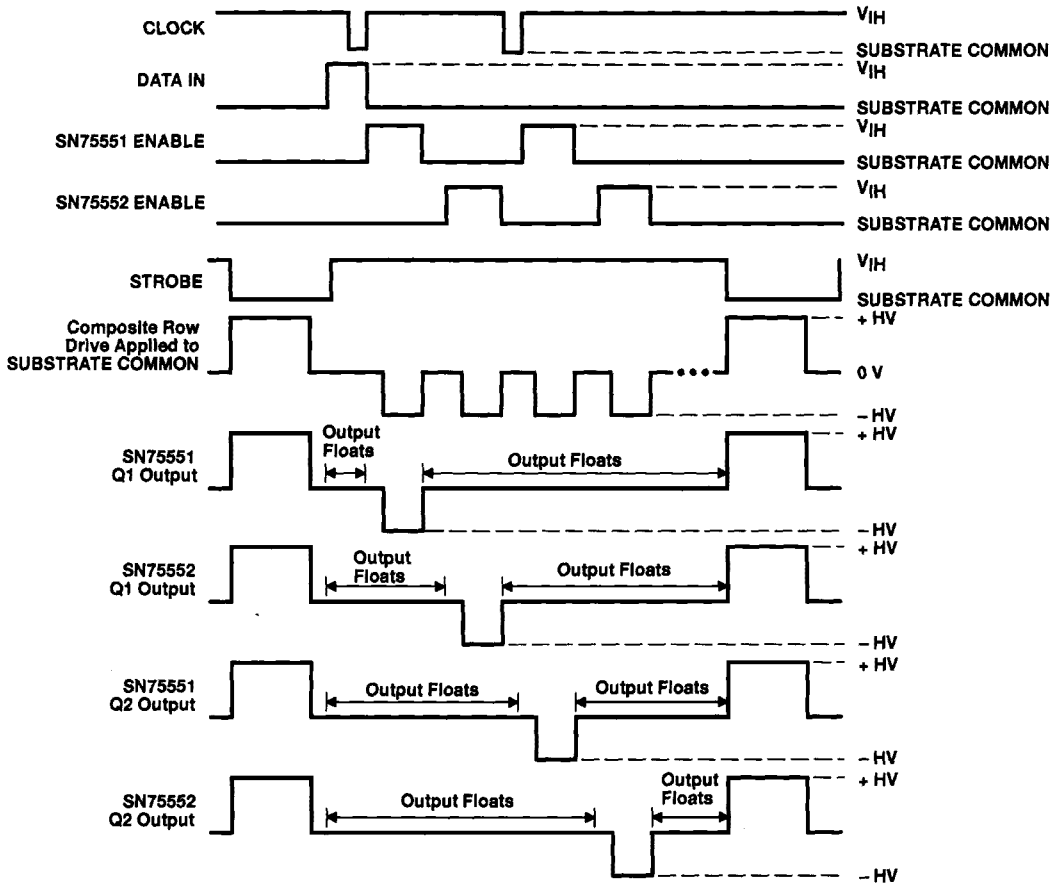

HV = high voltage

NOTE: During operation, CLOCK, DATA IN, ENABLE, and STROBE are referenced to the composite row drive signal received at SUBSTRATE COMMON of the device.

# SN65551, SN65552, SN75551, SN75552 ELECTROLUMINESCENT ROW DRIVERS

SLDS023B - D2743, MARCH 1983 - REVISED APRIL 1993

## schematics of inputs and outputs

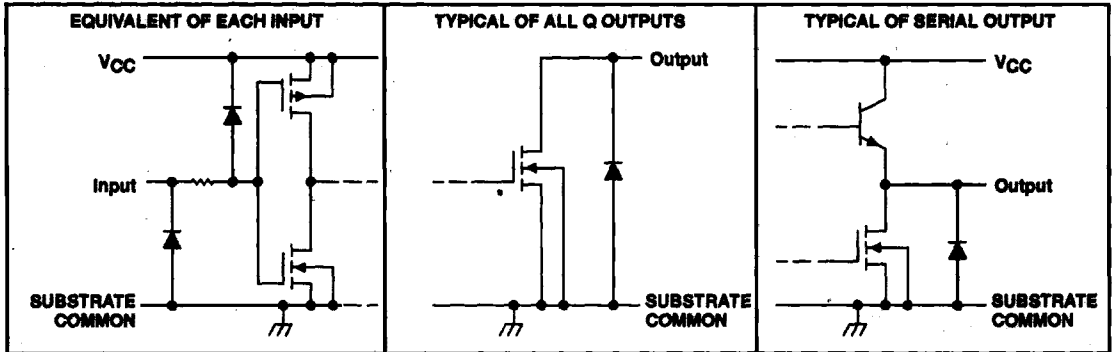

## absolute maximum ratings over operating free-air temperature range (unless otherwise noted)

Supply voltage, $V_{CC}$ (see Note 1)	18 V
Off-state Q output voltage, $V_{O(off)}$	225 V
Input voltage	$V_{CC} + 0.3$ V
Substrate common terminal current (see Note 2)	1.5 A
Continuous total power dissipation	See Dissipation Rating Table
Operating free-air temperature range: SN65551, SN65552	-40°C to 85°C
SN75551, SN75552	0°C to 70°C
Storage temperature range	-65°C to 150°C
Case temperature for 10 seconds: FN package	260°C
Lead temperature 1,6 mm (1/16 inch) from case for 10 seconds: N package	260°C

- NOTES: 1. Voltage values are with respect to SUBSTRATE COMMON.  
2. Duty cycle is limited by package dissipation.

DISSIPATION RATING TABLE

PACKAGE	$T_A \leq 25^\circ\text{C}$	DERATING FACTOR ABOVE $T_A = 25^\circ\text{C}$	$T_A = 70^\circ\text{C}$	$T_A = 85^\circ\text{C}$
	POWER RATING		POWER RATING	POWER RATING
FN	1700 mW	13.8 mW/°C	1088 mW	884 mW
N	1250 mW	10.0 mW/°C	800 mW	650 mW

# SN65551, SN65552, SN75551, SN75552 ELECTROLUMINESCENT ROW DRIVERS

SLDS023B - D2743, MARCH 1983 - REVISED APRIL 1993

## recommended operating conditions

		MIN	NOM	MAX	UNIT
Supply voltage, $V_{CC}$		10.8	12	15	V
High-level input voltage, $V_{IH}$ (see Figure 1)	$V_{CC} = 10.8\text{ V}$	8.1		11.1	V
	$V_{CC} = 15\text{ V}$	11.25		15.3	
Low-level input voltage, $V_{IL}$ (see Figure 1)	$V_{CC} = 10.8\text{ V}$	-0.3		2.7	V
	$V_{CC} = 15\text{ V}$	-0.3		3.75	
Off-state Q output voltage, $V_{O(off)}$		0		200	V
On-state output current, duty cycle $\leq 1\%$ , $I_{O(on)}$ (see Figures 2, 3, and 4)	$V_{CC} = 10.8\text{ V}$ , $T_A = 25^\circ\text{C}$			50	mA
	$V_{CC} = 15\text{ V}$ , $T_A = 25^\circ\text{C}$			80	
Output clamp current, $I_{OK}$				-45	mA
Clock frequency, $f_{clock}$		0		4	MHz
Pulse duration, CLOCK high or low, $t_w$		125			ns
Setup time, DATA IN before CLOCK, $t_{su}$ (see Figure 5)		50			ns
Hold time, DATA IN after CLOCK, $t_h$ (see Figure 5)		100			ns
Operating free-air temperature, $T_A$	SN65551, SN65552	-40		85	$^\circ\text{C}$
	SN75551, SN75552	0		70	

## electrical characteristics over recommended operating free-air temperature range

PARAMETER		TEST CONDITIONS		MIN	MAX	UNIT
$V_{OH}$	High-level output voltage	SERIAL OUT	$I_O = -100\ \mu\text{A}$	$V_{CC} - 1.5$		V
$V_{OL}$	Low-level output voltage	Q outputs	$I_{OL} = 50\text{ mA}$ , See Figure 3		30	V
		SERIAL OUT	$I_{OL} = 100\ \mu\text{A}$		1	
$I_{O(off)}$	Off-state Q-output current		$V_O = 200\text{ V}$		10	$\mu\text{A}$
$I_{IH}$	High-level input current		$V_I = V_{CC}$		1	$\mu\text{A}$
$I_{IL}$	Low-level input current		$V_I = 0$		-1	$\mu\text{A}$
$I_{CC}$	Supply current from $V_{CC}$				250	mA

## switching characteristics, $V_{CC} = 12\text{ V}$ , $T_A = 25^\circ\text{C}$

PARAMETER		TEST CONDITIONS		MIN	MAX	UNIT
$t_{PHL}$	Propagation delay time, high-to-low level, SERIAL OUT from CLOCK	$C_L = 20\ \text{pF}$ to GND, See Figure 6			200	ns
$t_{PLH}$	Propagation delay time, low-to-high level, SERIAL OUT from CLOCK				200	
$t_{d(on)}$	Turn-on delay time, Q outputs from ENABLE	$I_{OL} = 50\text{ mA}$ , $R_L = 1.4\ \text{k}\Omega$ to 100 V,	STROBE at $V_{CC}$ , See Figure 7		500	ns



RECOMMENDED OPERATING CONDITIONS

INPUT VOLTAGE LOGIC-LEVEL LIMITS  
vs  
SUPPLY VOLTAGE  $V_{CC}$

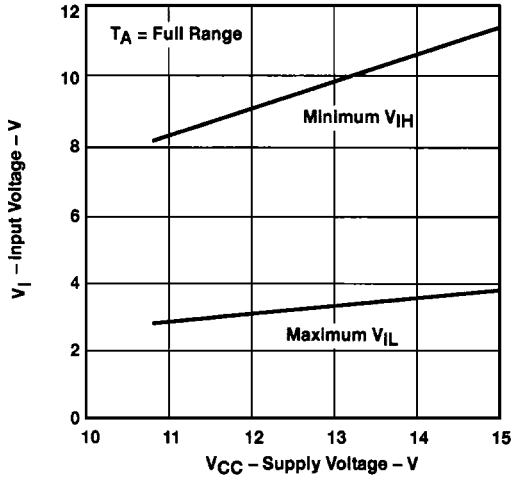

Figure 1

MAXIMUM ON-STATE Q OUTPUT CURRENT  
vs  
SUPPLY VOLTAGE

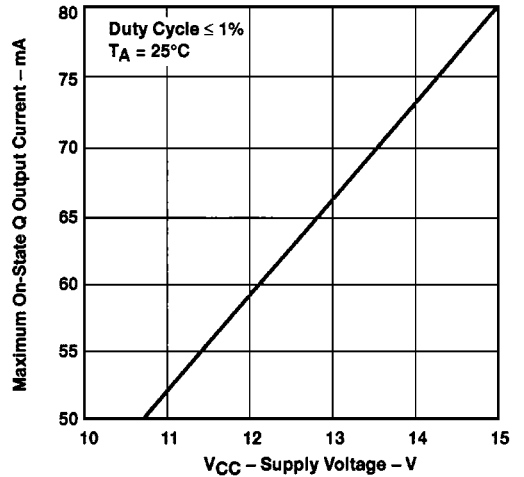
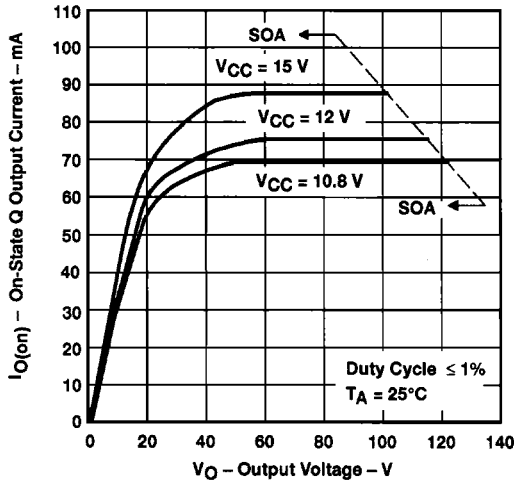

Figure 2

ON-STATE Q OUTPUT CURRENT  
vs  
OUTPUT VOLTAGE



SOA = Safe Operating Area

Figure 3

OUTPUT SATURATION CURRENT  
vs  
FREE-AIR TEMPERATURE†

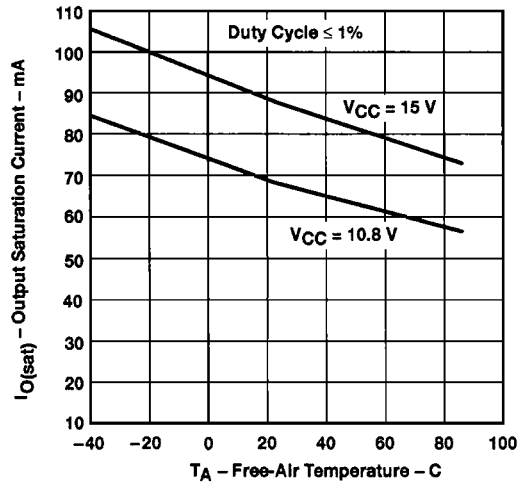

Figure 4

† Data for temperatures between 0°C and 70°C apply only for the SN75551 and SN75552 devices.



**SN65551, SN65552, SN75551, SN75552  
ELECTROLUMINESCENT ROW DRIVERS**

SLDS023B - D2743, MARCH 1983 - REVISED APRIL 1993

**PARAMETER MEASUREMENT INFORMATION**

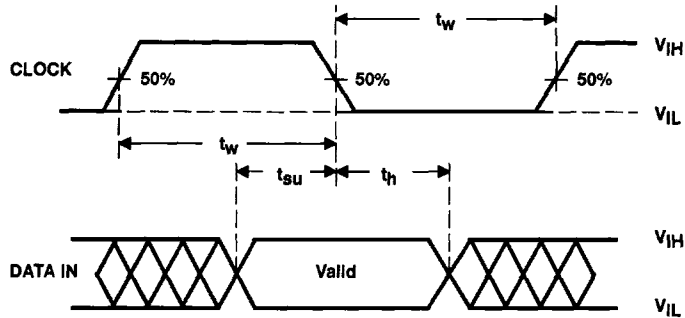

**Figure 5. Input Timing Voltage Waveforms**

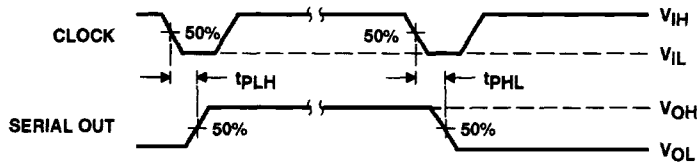

**Figure 6. Voltage Waveforms, SERIAL OUT**

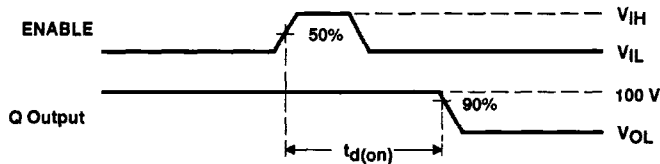

**Figure 7. Voltage Waveforms, Q Outputs**