

TLC2272M-MIL Advanced LinCMOS Rail-to-Rail Operational Amplifier

1 Features

- Output Swing Includes Both Supply Rails
- Low Noise: 9 nV/ $\sqrt{\text{Hz}}$ Typical at $f = 1$ kHz
- Low-Input Bias Current: 1-pA Typical
- Fully-Specified for Both Single-Supply and Split-Supply Operation
- Common-Mode Input Voltage Range Includes Negative Rail
- High-Gain Bandwidth: 2.2-MHz Typical
- High Slew Rate: 3.6-V/ μs Typical
- Low Input Offset Voltage: 2.5 mV Maximum at $T_A = 25^\circ\text{C}$
- Macromodel Included
- Performance Upgrades for the TLC272 and TLC274
- Available in Q-Temp Automotive

2 Applications

- White Goods (Refrigerators, Washing Machines)
- Hand-held Monitoring Systems
- Configuration Control and Print Support
- Transducer Interfaces
- Battery-Powered Applications

3 Description

The TLC2272M-MIL device is a dual operational amplifier from Texas Instruments. The device exhibits rail-to-rail output performance for increased dynamic range in single- or split-supply applications. The TLC2272M-MIL device offers 2 MHz of bandwidth and 3 V/ μs of slew rate for higher-speed applications. This device offers comparable ac performance while having better noise, input offset voltage, and power dissipation than existing CMOS operational amplifiers. The TLC2272M-MIL device has a noise voltage of 9 nV/ $\sqrt{\text{Hz}}$, two times lower than competitive solutions.

The TLC2272M-MIL device, exhibiting high input impedance and low noise, is excellent for small-signal conditioning for high-impedance sources such as piezoelectric transducers. Because of the micropower dissipation levels, the device works well in hand-held monitoring and remote-sensing applications. In addition, the rail-to-rail output feature, with single- or split-supplies, makes this device a great choice when interfacing with analog-to-digital converters (ADCs). For precision applications, the TLC2272AM-MIL device is available with a maximum input offset voltage of 950 μV . This device is fully characterized at 5 V and ± 5 V.

The TLC2272M-MIL device also makes a great upgrade to the TLC272 in standard designs, offering increased output dynamic range, lower noise voltage, and lower input offset voltage. This enhanced feature set allows the device to be used in a wider range of applications. For applications that require higher output drive and wider input voltage range, see the TLV2432 and TLV2442 devices.

If the design requires single amplifiers, see the TLV2211, TLV2221 and TLV2231 family. These devices are single rail-to-rail operational amplifiers in the SOT-23 package. Their small size and low power consumption make them ideal for high density, battery-powered equipment.

Device Information⁽¹⁾

PART NUMBER	PACKAGE	BODY SIZE (NOM)
TLC2272M-MIL	SOIC (8)	3,91 mm x 4,90 mm
	CDIP (8)	6,67 mm x 9,60 mm
	LCCC (20)	8,89 mm x 8,89 mm
	CFP (10)	6,35 mm x 6,35 mm

(1) For all available packages, see the orderable addendum at the end of the data sheet.

Maximum Peak-to-Peak Output Voltage vs Supply Voltage

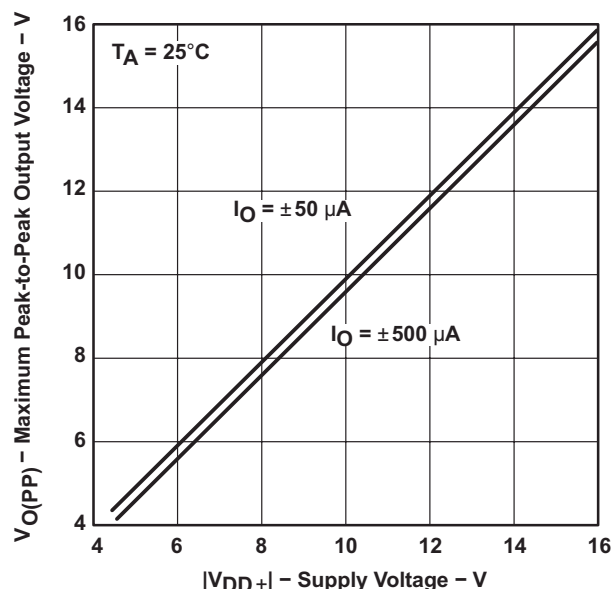

Table of Contents

1 Features	1	7.3 Feature Description	20
2 Applications	1	7.4 Device Functional Modes	20
3 Description	1	8 Application and Implementation	21
4 Revision History	2	8.1 Application Information	21
5 Pin Configuration and Functions	3	8.2 Typical Application	22
6 Specifications	5	9 Power Supply Recommendations	24
6.1 Absolute Maximum Ratings	5	10 Layout	25
6.2 ESD Ratings	5	10.1 Layout Guidelines	25
6.3 Recommended Operating Conditions	5	10.2 Layout Example	25
6.4 Thermal Information	5	11 Device and Documentation Support	26
6.5 TLC2272M-MIL Electrical Characteristics $V_{DD} = 5\text{ V}$	6	11.1 Receiving Notification of Documentation Updates	26
6.6 TLC2272M-MIL Electrical Characteristics $V_{DD\pm} = \pm 5\text{ V}$	8	11.2 Community Resources	26
6.7 Typical Characteristics	10	11.3 Trademarks	26
7 Detailed Description	20	11.4 Electrostatic Discharge Caution	26
7.1 Overview	20	11.5 Glossary	26
7.2 Functional Block Diagram	20	12 Mechanical, Packaging, and Orderable Information	26

4 Revision History

DATE	REVISION	NOTE
June 2017	*	Initial release

5 Pin Configuration and Functions

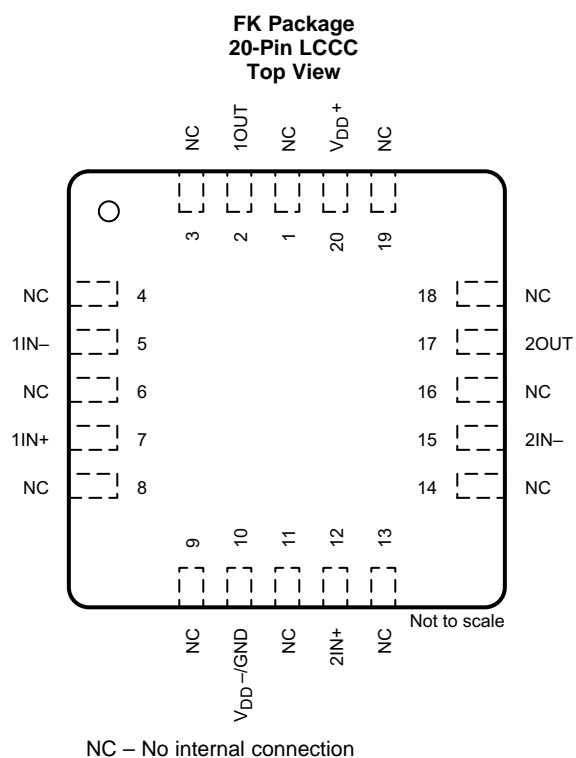
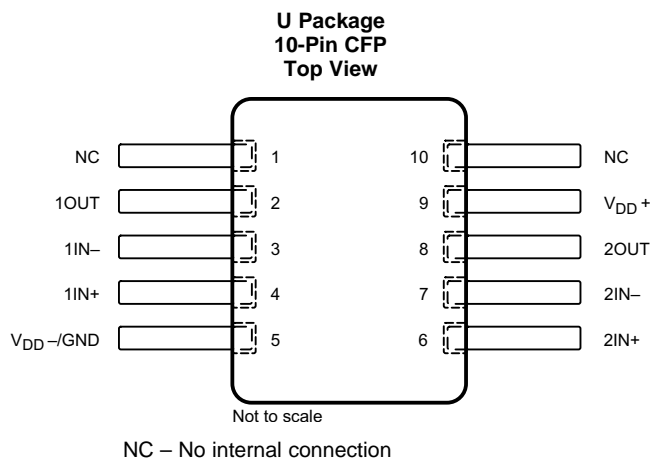
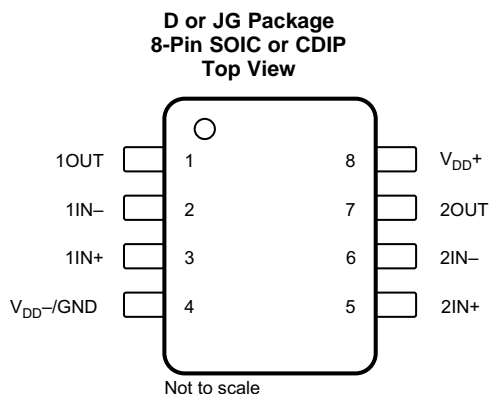

Pin Functions

NAME	PIN			I/O	DESCRIPTION
	NO.				
	D or JG	FK	U		
1IN+	3	7	4	I	Non-inverting input, Channel 1
1IN–	2	5	3	I	Inverting input, Channel 1
1OUT	1	2	2	O	Output, Channel 1
2IN+	5	12	6	I	Non-inverting input, Channel 2
2IN–	6	15	7	I	Inverting input, Channel 2
2OUT	7	17	8	O	Output, Channel 2
V _{DD} +	8	20	9	—	Positive (highest) supply
V _{DD} –	—	—	—	—	Negative (lowest) supply
V _{DD} –/GND	4	10	5	—	Negative (lowest) supply
NC	—	1, 3, 4, 6, 8, 9, 11, 13, 14, 16, 18, 19	1, 10	—	No connection

6 Specifications

6.1 Absolute Maximum Ratings

over operating ambient temperature range (unless otherwise noted)⁽¹⁾

	MIN	MAX	UNIT
Supply voltage, V_{DD+} ⁽²⁾		8	V
V_{DD-} ⁽²⁾	–8		V
Differential input voltage, V_{ID} ⁽³⁾		±16	V
Input voltage, V_I (any input) ⁽²⁾	$V_{DD-} - 0.3$	V_{DD+}	V
Input current, I_I (any input)		±5	mA
Output current, I_O		±50	mA
Total current into V_{DD+}		±50	mA
Total current out of V_{DD-}		±50	mA
Duration of short-circuit current at (or below) 25°C ⁽⁴⁾		Unlimited	
Operating ambient temperature range, T_A	–55	125	
Storage temperature, T_{stg}	–65	150	°C

- (1) Stresses beyond those listed under *Absolute Maximum Ratings* may cause permanent damage to the device. These are stress ratings only, which do not imply functional operation of the device at these or any other conditions beyond those indicated under *Recommended Operating Conditions*. Exposure to absolute-maximum-rated conditions for extended periods may affect device reliability.
- (2) All voltage values, except differential voltages, are with respect to the midpoint between V_{DD+} and V_{DD-} .
- (3) Differential voltages are at IN+ with respect to IN–. Excessive current will flow if input is brought below $V_{DD-} - 0.3$ V.
- (4) The output may be shorted to either supply. Temperature or supply voltages must be limited to ensure that the maximum dissipation rating is not exceeded.

6.2 ESD Ratings

			VALUE	UNIT
$V_{(ESD)}$ Electrostatic discharge	Human-body model (HBM), per AEC Q100-002 ⁽¹⁾	Devices in D packages	±2000	V
	Charged-device model (CDM), per AEC Q100-011	Devices in D packages	±1000	

- (1) AEC Q100-002 indicates that HBM stressing shall be in accordance with the ANSI/ESDA/JEDEC JS-001 specification.

6.3 Recommended Operating Conditions

		MIN	MAX	UNIT
$V_{DD±}$	Supply voltage	±2.2	±8	V
V_I	Input voltage	V_{DD-}	$V_{DD+} - 1.5$	V
V_{IC}	Common-mode input voltage	V_{DD-}	$V_{DD+} - 1.5$	V
T_A	Operating ambient temperature	–55	125	°C

6.4 Thermal Information

THERMAL METRIC ⁽¹⁾		TLC2272M-MIL				UNIT
		D (SOIC)	JG (CDIP)	FK (LCCC)	U (CFP)	
		8-PIN		20-PIN	10-PIN	
$R_{θJA}$	Junction-to-ambient thermal resistance ⁽²⁾⁽³⁾	115.6		—	—	°C/W
$R_{θJC(top)}$	Junction-to-case (top) thermal resistance ⁽²⁾⁽³⁾	61.8		18	121.3	°C/W
$R_{θJB}$	Junction-to-board thermal resistance	55.9		—	—	°C/W
$ψ_{JT}$	Junction-to-top characterization parameter	14.3		—	—	°C/W
$ψ_{JB}$	Junction-to-board characterization parameter	55.4		—	—	°C/W
$R_{θJC(bot)}$	Junction-to-case (bottom) thermal resistance	—		—	8.68	°C/W

- (1) For more information about traditional and new thermal metrics, see *Semiconductor and IC Package Thermal Metrics*.
- (2) Maximum power dissipation is a function of $T_{J(max)}$, $R_{θJA}$, and T_A . The maximum allowable power dissipation at any allowable ambient temperature is $P_D = (T_{J(max)} - T_A) / R_{θJA}$. Operating at the absolute maximum T_J of 150°C can affect reliability.
- (3) The package thermal impedance is calculated in accordance with JESD 51-7 (plastic) or MIL-STD-883 Method 1012 (ceramic).

6.5 TLC2272M-MIL Electrical Characteristics $V_{DD} = 5\text{ V}$

at specified ambient temperature, $V_{DD} = 5\text{ V}$; $T_A = 25^\circ\text{C}$, unless otherwise noted.

PARAMETER		TEST CONDITIONS		MIN	TYP	MAX	UNIT	
V_{IO}	Input offset voltage	$V_{IC} = 0\text{ V}$, $V_{DD\pm} = \pm 2.5\text{ V}$, $V_O = 0\text{ V}$, $R_S = 50\ \Omega$	$T_A = 25^\circ\text{C}$		300	2500	μV	
			$T_A = -55^\circ\text{C}$ to 125°C			3000		
α_{VIO}	Temperature coefficient of input offset voltage	$V_{IC} = 0\text{ V}$, $V_{DD\pm} = \pm 2.5\text{ V}$, $V_O = 0\text{ V}$, $R_S = 50\ \Omega$			2		$\mu\text{V}/^\circ\text{C}$	
	Input offset voltage long-term drift ⁽¹⁾	$V_{IC} = 0\text{ V}$, $V_{DD\pm} = \pm 2.5\text{ V}$, $V_O = 0\text{ V}$, $R_S = 50\ \Omega$			0.002		$\mu\text{V}/\text{mo}$	
I_{IO}	Input offset current	$V_{IC} = 0\text{ V}$, $V_{DD\pm} = \pm 2.5\text{ V}$, $V_O = 0\text{ V}$, $R_S = 50\ \Omega$	$T_A = 25^\circ\text{C}$		0.5	60	pA	
			$T_A = -55^\circ\text{C}$ to 125°C			800		
I_{IB}	Input bias current	$V_{IC} = 0\text{ V}$, $V_{DD\pm} = \pm 2.5\text{ V}$, $V_O = 0\text{ V}$, $R_S = 50\ \Omega$	$T_A = 25^\circ\text{C}$		1	60	pA	
			$T_A = -55^\circ\text{C}$ to 125°C			800		
V_{ICR}	Common-mode input voltage	$R_S = 50\ \Omega$; $ V_{IO} \leq 5\text{ mV}$	$T_A = 25^\circ\text{C}$		-0.3	2.5	4	V
			$T_A = -55^\circ\text{C}$ to 125°C		0	2.5	3.5	
V_{OH}	High-level output voltage		$I_{OH} = -20\ \mu\text{A}$		4.99		V	
			$I_{OH} = -200\ \mu\text{A}$	$T_A = 25^\circ\text{C}$	4.85	4.93		
				$T_A = -55^\circ\text{C}$ to 125°C	4.85			
			$I_{OH} = -1\text{ mA}$	$T_A = 25^\circ\text{C}$	4.25	4.65		
$T_A = -55^\circ\text{C}$ to 125°C	4.25							
V_{OL}	Low-level output voltage	$V_{IC} = 2.5\text{ V}$	$I_{OL} = 50\ \mu\text{A}$	$T_A = 25^\circ\text{C}$	0.01		V	
				$T_A = -55^\circ\text{C}$ to 125°C	0.09	0.15		
			$I_{OL} = 500\ \mu\text{A}$	$T_A = 25^\circ\text{C}$		0.15		
				$T_A = -55^\circ\text{C}$ to 125°C	0.9	1.5		
A_{VD}	Large-signal differential voltage amplification	$V_{IC} = 2.5\text{ V}$, $V_O = 1\text{ V}$ to 4 V , $R_L = 10\text{ k}\Omega^{(2)}$	$T_A = 25^\circ\text{C}$		10	35	V/mV	
			$T_A = -55^\circ\text{C}$ to 125°C		10			
		$V_{IC} = 2.5\text{ V}$, $V_O = 1\text{ V}$ to 4 V , $R_L = 1\text{ M}\Omega^{(2)}$			175			
r_{id}	Differential input resistance				10^{12}		Ω	
r_i	Common-mode input resistance				10^{12}		Ω	
c_i	Common-mode input capacitance	$f = 10\text{ kHz}$, P package			8		pF	
z_o	Closed-loop output impedance	$f = 1\text{ MHz}$, $A_V = 10$			140		Ω	
CMRR	Common-mode rejection ratio	$V_{IC} = 0\text{ V}$ to 2.7 V , $V_O = 2.5\text{ V}$, $R_S = 50\ \Omega$	$T_A = 25^\circ\text{C}$		70	75	dB	
			$T_A = -55^\circ\text{C}$ to 125°C		70			
k_{SVR}	Supply-voltage rejection ratio ($\Delta V_{DD} / \Delta V_{IO}$)	$V_{DD} = 4.4\text{ V}$ to 16 V , $V_{IC} = V_{DD} / 2$, no load	$T_A = 25^\circ\text{C}$		80	95	dB	
			$T_A = -55^\circ\text{C}$ to 125°C		80			
I_{DD}	Supply current	$V_O = 2.5\text{ V}$, no load	$T_A = 25^\circ\text{C}$		2.2	3	mA	
			$T_A = -55^\circ\text{C}$ to 125°C			3		
SR	Slew rate at unity gain	$V_O = 0.5\text{ V}$ to 2.5 V , $R_L = 10\text{ k}\Omega^{(2)}$, $C_L = 100\text{ pF}^{(2)}$	$T_A = 25^\circ\text{C}$		2.3	3.6	$\text{V}/\mu\text{s}$	
			$T_A = -55^\circ\text{C}$ to 125°C		1.7			
V_n	Equivalent input noise voltage		$f = 10\text{ Hz}$		50		$\text{nV}/\sqrt{\text{Hz}}$	
			$f = 1\text{ kHz}$		9			
V_{NPP}	Peak-to-peak equivalent input noise voltage		$f = 0.1\text{ Hz}$ to 1 Hz		1		μV	
			$f = 0.1\text{ Hz}$ to 10 Hz		1.4			
I_n	Equivalent input noise current				0.6		$\text{fA}/\sqrt{\text{Hz}}$	
THD+N	Total harmonic distortion + noise	$V_O = 0.5\text{ V}$ to 2.5 V , $f = 20\text{ kHz}$, $R_L = 10\text{ k}\Omega^{(2)}$	$A_V = 1$		0.0013%			
			$A_V = 10$		0.004%			
			$A_V = 100$		0.03%			
	Gain-bandwidth product	$f = 10\text{ kHz}$, $R_L = 10\text{ k}\Omega^{(2)}$, $C_L = 100\text{ pF}^{(2)}$			2.18		MHz	
B_{OM}	Maximum output-swing bandwidth	$V_{O(PP)} = 2\text{ V}$, $A_V = 1$, $R_L = 10\text{ k}\Omega^{(2)}$, $C_L = 100\text{ pF}^{(2)}$			1		MHz	
t_s	Settling time	$A_V = -1$, $R_L = 10\text{ k}\Omega^{(2)}$, Step = 0.5 V to 2.5 V , $C_L = 100\text{ pF}^{(2)}$	To 0.1%		1.5		μs	
			To 0.01%		2.6			

(1) Typical values are based on the input offset voltage shift observed through 168 hours of operating life test at $T_A = 150^\circ\text{C}$ extrapolated to $T_A = 25^\circ\text{C}$ using the Arrhenius equation and assuming an activation energy of 0.96 eV .

(2) Referred to 0 V .

TLC2272M-MIL Electrical Characteristics $V_{DD} = 5\text{ V}$ (continued)

 at specified ambient temperature, $V_{DD} = 5\text{ V}$; $T_A = 25^\circ\text{C}$, unless otherwise noted.

PARAMETER		TEST CONDITIONS	MIN	TYP	MAX	UNIT
ϕ_m	Phase margin at unity gain	$R_L = 10\text{ k}\Omega^{(2)}$, $C_L = 100\text{ pF}^{(2)}$		50		$^\circ$
	Gain margin	$R_L = 10\text{ k}\Omega^{(2)}$, $C_L = 100\text{ pF}^{(2)}$		10		dB

6.6 TLC2272M-MIL Electrical Characteristics $V_{DD\pm} = \pm 5\text{ V}$

at specified ambient temperature, $V_{DD\pm} = \pm 5\text{ V}$; $T_A = 25^\circ\text{C}$, unless otherwise noted.

PARAMETER		TEST CONDITIONS		MIN	TYP	MAX	UNIT	
V_{IO}	Input offset voltage	$V_{IC} = 0\text{ V}$, $V_O = 0\text{ V}$, $R_S = 50\ \Omega$	$T_A = 25^\circ\text{C}$		300	2500	μV	
			$T_A = -55^\circ\text{C}$ to 125°C			3000		
α_{VIO}	Temperature coefficient of input offset voltage	$V_{IC} = 0\text{ V}$, $V_O = 0\text{ V}$, $R_S = 50\ \Omega$			2		$\mu\text{V}/^\circ\text{C}$	
	Input offset voltage long-term drift ⁽¹⁾	$V_{IC} = 0\text{ V}$, $V_O = 0\text{ V}$, $R_S = 50\ \Omega$			0.002		$\mu\text{V}/\text{mo}$	
I_{IO}	Input offset current	$V_{IC} = 0\text{ V}$, $V_O = 0\text{ V}$, $R_S = 50\ \Omega$	$T_A = 25^\circ\text{C}$		0.5	60	pA	
			$T_A = -55^\circ\text{C}$ to 125°C			800		
I_{IB}	Input bias current	$V_{IC} = 0\text{ V}$, $V_O = 0\text{ V}$, $R_S = 50\ \Omega$	$T_A = 25^\circ\text{C}$		1	60	pA	
			$T_A = -55^\circ\text{C}$ to 125°C			800		
V_{ICR}	Common-mode input voltage	$R_S = 50\ \Omega$; $ V_{IO} \leq 5\text{ mV}$	$T_A = 25^\circ\text{C}$		-5.3	0	4	V
			$T_A = -55^\circ\text{C}$ to 125°C		-5	0	3.5	
V_{OM+}	Maximum positive peak output voltage	$V_{IC} = 0\text{ V}$	$I_O = -20\ \mu\text{A}$		4.99		V	
			$I_O = -200\ \mu\text{A}$	$T_A = 25^\circ\text{C}$	4.85	4.93		
				$T_A = -55^\circ\text{C}$ to 125°C	4.85			
			$I_O = -1\text{ mA}$	$T_A = 25^\circ\text{C}$	4.25	4.65		
$T_A = -55^\circ\text{C}$ to 125°C	4.25							
V_{OM-}	Maximum negative peak output voltage	$V_{IC} = 0\text{ V}$	$I_O = 50\ \mu\text{A}$		-4.99		V	
			$I_O = 500\ \mu\text{A}$	$T_A = 25^\circ\text{C}$	-4.85	-4.91		
				$T_A = -55^\circ\text{C}$ to 125°C	-4.85			
			$I_O = 5\text{ mA}$	$T_A = 25^\circ\text{C}$	-3.5	-4.1		
$T_A = -55^\circ\text{C}$ to 125°C	-3.5							
A_{VD}	Large-signal differential voltage amplification	$V_O = \pm 4\text{ V}$; $R_L = 10\text{ k}\Omega$	$T_A = 25^\circ\text{C}$		20	50	V/mV	
			$T_A = -55^\circ\text{C}$ to 125°C		20			
		$V_O = \pm 4\text{ V}$; $R_L = 1\text{ M}\Omega$			300			
r_{id}	Differential input resistance				10^{12}		Ω	
r_i	Common-mode input resistance				10^{12}		Ω	
c_i	Common-mode input capacitance	$f = 10\text{ kHz}$, P package			8		pF	
z_o	Closed-loop output impedance	$f = 1\text{ MHz}$, $A_V = 10$			130		Ω	
CMRR	Common-mode rejection ratio	$V_{IC} = -5\text{ V}$ to 2.7 V , $V_O = 0\text{ V}$, $R_S = 50\ \Omega$	$T_A = 25^\circ\text{C}$		75	80	dB	
			$T_A = -55^\circ\text{C}$ to 125°C		75			
k_{SVR}	Supply-voltage rejection ratio ($\Delta V_{DD} / \Delta V_{IO}$)	$V_{DD+} = 2.2\text{ V}$ to $\pm 8\text{ V}$, $V_{IC} = 0\text{ V}$, no load	$T_A = 25^\circ\text{C}$		80	95	dB	
			$T_A = -55^\circ\text{C}$ to 125°C		80			
I_{DD}	Supply current	$V_O = 0\text{ V}$, no load	$T_A = 25^\circ\text{C}$		2.4	3	mA	
			$T_A = -55^\circ\text{C}$ to 125°C			3		
SR	Slew rate at unity gain	$V_O = \pm 2.3\text{ V}$, $R_L = 10\text{ k}\Omega$, $C_L = 100\text{ pF}$	$T_A = 25^\circ\text{C}$		2.3	3.6	$\text{V}/\mu\text{s}$	
			$T_A = -55^\circ\text{C}$ to 125°C		1.7			
V_n	Equivalent input noise voltage	$f = 10\text{ Hz}$			50		$\text{nV}/\sqrt{\text{Hz}}$	
		$f = 1\text{ kHz}$			9			
V_{NPP}	Peak-to-peak equivalent input noise voltage	$f = 0.1\text{ Hz}$ to 1 Hz			1		μV	
		$f = 0.1\text{ Hz}$ to 10 Hz			1.4			
I_n	Equivalent input noise current				0.6		$\text{fA}/\sqrt{\text{Hz}}$	
THD+N	Total harmonic distortion + noise	$V_O = \pm 2.3$, $f = 20\text{ kHz}$, $R_L = 10\text{ k}\Omega$	$A_V = 1$		0.0011%			
			$A_V = 10$		0.004%			
			$A_V = 100$		0.03%			
	Gain-bandwidth product	$f = 10\text{ kHz}$, $R_L = 10\text{ k}\Omega$, $C_L = 100\text{ pF}$			2.25		MHz	
B_{OM}	Maximum output-swing bandwidth	$V_{O(PP)} = 4.6\text{ V}$, $A_V = 1$, $R_L = 10\text{ k}\Omega$, $C_L = 100\text{ pF}$			0.54		MHz	
t_s	Settling time	$A_V = -1$, $R_L = 10\text{ k}\Omega$, Step = -2.3 V to 2.3 V , $C_L = 100\text{ pF}$	$T_O = 0.1\%$		1.5		μs	
			$T_O = 0.01\%$		3.2			
ϕ_m	Phase margin at unity gain	$R_L = 10\text{ k}\Omega$, $C_L = 100\text{ pF}$			52		$^\circ$	

(1) Typical values are based on the input offset voltage shift observed through 168 hours of operating life test at $T_A = 150^\circ\text{C}$ extrapolated to $T_A = 25^\circ\text{C}$ using the Arrhenius equation and assuming an activation energy of 0.96 eV .

TLC2272M-MIL Electrical Characteristics $V_{DD\pm} = \pm 5\text{ V}$ (continued)

 at specified ambient temperature, $V_{DD\pm} = \pm 5\text{ V}$; $T_A = 25^\circ\text{C}$, unless otherwise noted.

PARAMETER	TEST CONDITIONS	MIN	TYP	MAX	UNIT
Gain margin	$R_L = 10\text{ k}\Omega$, $C_L = 100\text{ pF}$		10		dB

6.7 Typical Characteristics

Table 1. Table of Graphs

			FIGURE⁽¹⁾
V_{IO}	Input offset voltage	Distribution	1, 2
		vs Common-mode voltage	3, 4
α_{VIO}	Input offset voltage temperature coefficient	Distribution	5, 6 ⁽²⁾
I_{IB} / I_{IO}	Input bias and input offset current	vs ambient temperature	7 ⁽²⁾
V_I	Input voltage	vs Supply voltage	8
		vs ambient temperature	9 ⁽²⁾
V_{OH}	High-level output voltage	vs High-level output current	10 ⁽²⁾
V_{OL}	Low-level output voltage	vs Low-level output current	11, 12 ⁽²⁾
V_{OM+}	Maximum positive peak output voltage	vs Output current	13 ⁽²⁾
V_{OM-}	Maximum negative peak output voltage	vs Output current	14 ⁽²⁾
$V_{O(PP)}$	Maximum peak-to-peak output voltage	vs Frequency	15
I_{OS}	Short-circuit output current	vs Supply voltage	16
		vs ambient temperature	17 ⁽²⁾
V_O	Output voltage	vs Differential input voltage	18, 19
A_{VD}	Large-signal differential voltage amplification	vs Load resistance	20
	Large-signal differential voltage amplification and phase margin	vs Frequency	21, 22
	Large-signal differential voltage amplification	vs ambient temperature	23 ⁽²⁾ , 24 ⁽²⁾
z_0	Output impedance	vs Frequency	25, 26
CMRR	Common-mode rejection ratio	vs Frequency	27
		vs ambient temperature	28
k_{SVR}	Supply-voltage rejection ratio	vs Frequency	29, 30
		vs ambient temperature	31 ⁽²⁾
I_{DD}	Supply current	vs Supply voltage	32 ⁽²⁾ , (2)
		vs ambient temperature	33 ⁽²⁾ , (2)
SR	Slew rate	vs Load Capacitance	34
		vs ambient temperature	35 ⁽²⁾
V_O	Inverting large-signal pulse response		36, 37
	Voltage-follower large-signal pulse response		38, 39
	Inverting small-signal pulse response		40, 41
	Voltage-follower small-signal pulse response		42, 43
V_n	Equivalent input noise voltage	vs Frequency	44, 45
	Noise voltage over a 10-second period		46
	Integrated noise voltage	vs Frequency	47
THD+N	Total harmonic distortion + noise	vs Frequency	48
		Gain-bandwidth product	vs Supply voltage
		vs ambient temperature	50 ⁽²⁾
ϕ_m	Phase margin	vs Load capacitance	51
	Gain margin	vs Load capacitance	52

(1) For all graphs where $V_{DD} = 5\text{ V}$, all loads are referenced to 2.5 V.

(2) Data at high and low temperatures are applicable only within the rated operating ambient temperature range of the device.

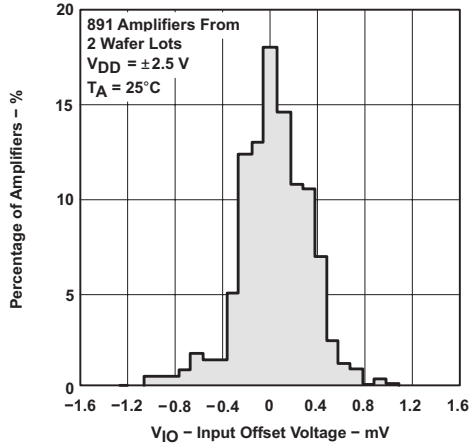

Figure 1. Distribution of Input Offset Voltage

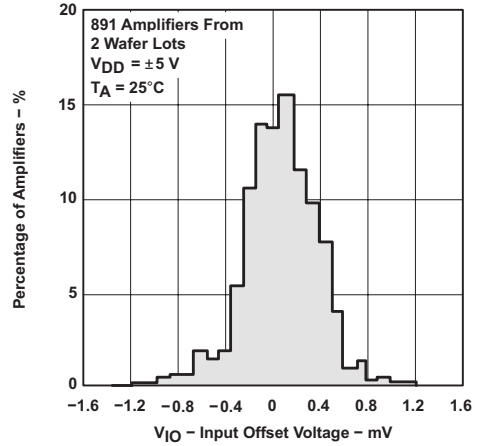

Figure 2. Distribution of Input Offset Voltage

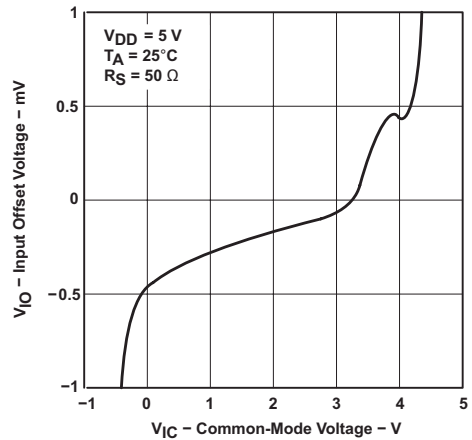

Figure 3. Input Offset Voltage vs Common-Mode Voltage

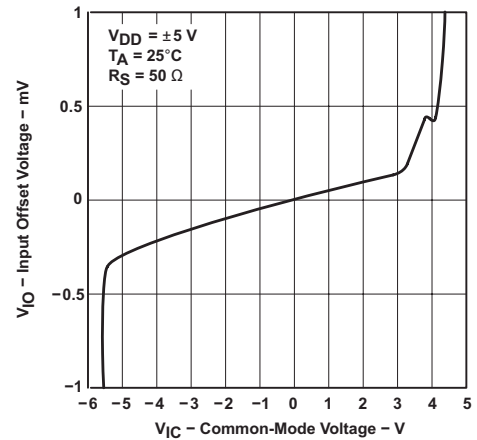

Figure 4. Input Offset Voltage vs Common-Mode Voltage

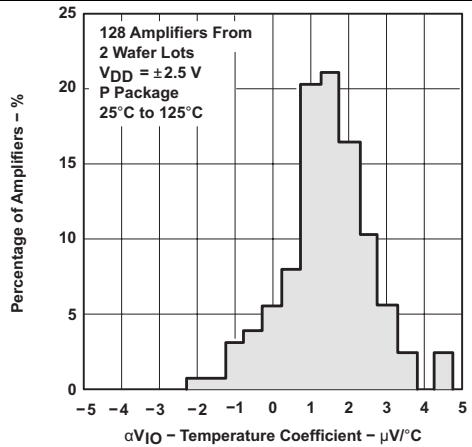

Figure 5. Distribution of Amplifiers vs Input Offset Voltage Temperature Coefficient

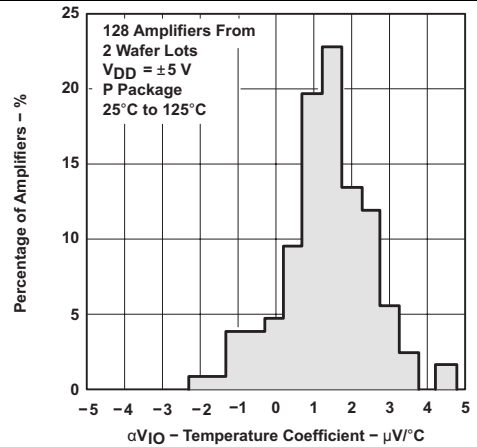

Figure 6. Distribution of Amplifiers vs Input Offset Voltage Temperature Coefficient

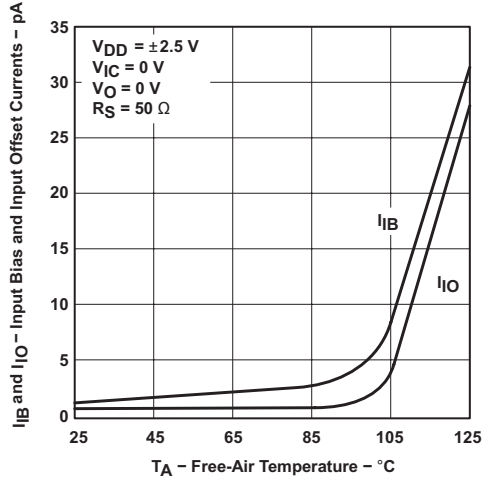

Figure 7. Input Bias and Input Offset Current vs Ambient Temperature

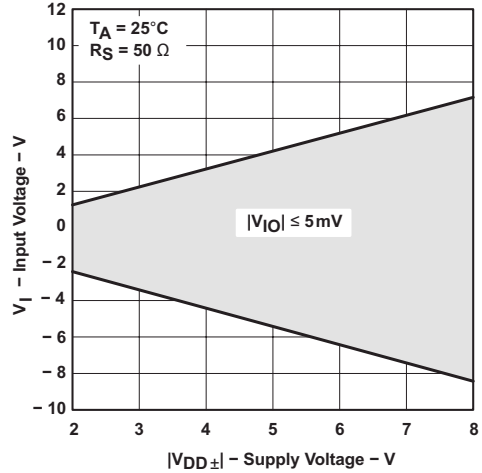

Figure 8. Input Voltage vs Supply Voltage

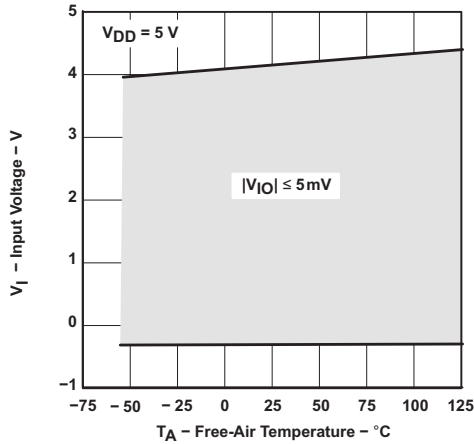

Figure 9. Input Voltage vs Ambient Temperature

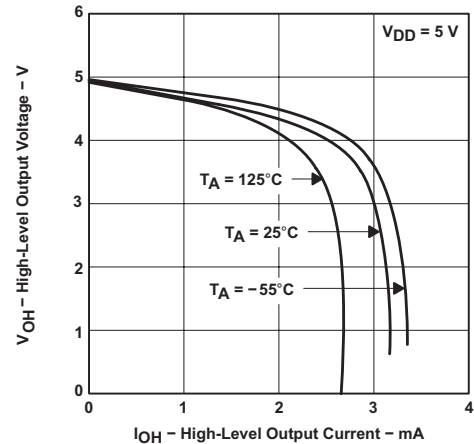

Figure 10. High-Level Output Voltage vs High-Level Output Current

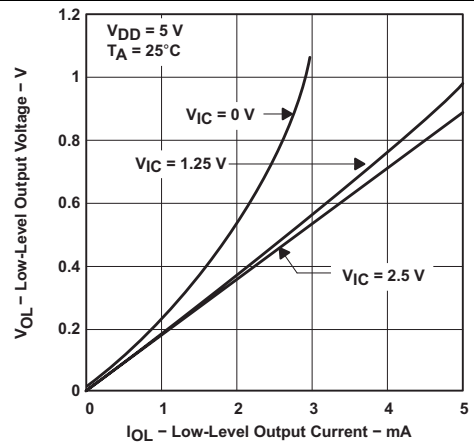

Figure 11. Low-Level Output Voltage vs Low-Level Output Current

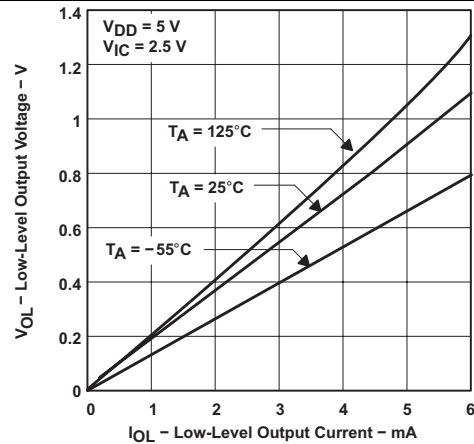

Figure 12. Low-Level Output Voltage vs Low-Level Output Current

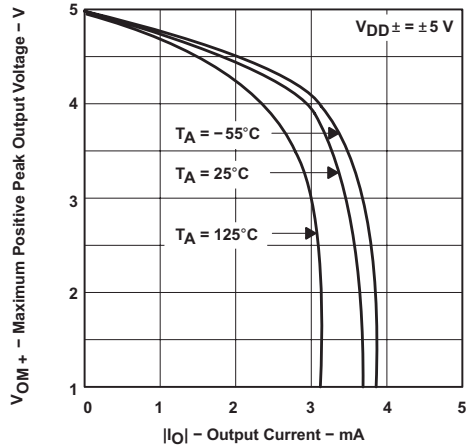

Figure 13. Maximum Positive Peak Output Voltage vs Output Current

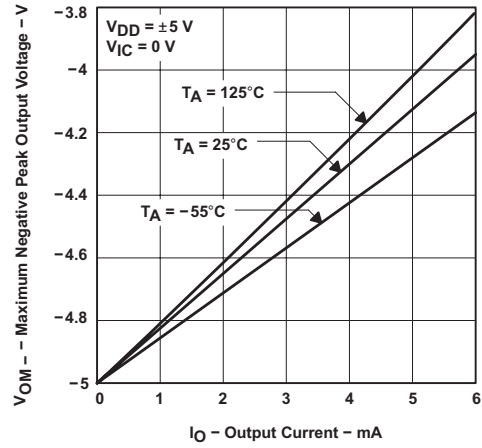

Figure 14. Maximum Negative Peak Output Voltage vs Output Current

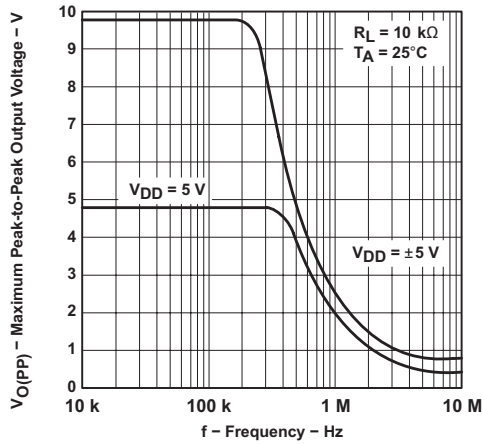

Figure 15. Maximum Peak-to-Peak Output Voltage vs Frequency

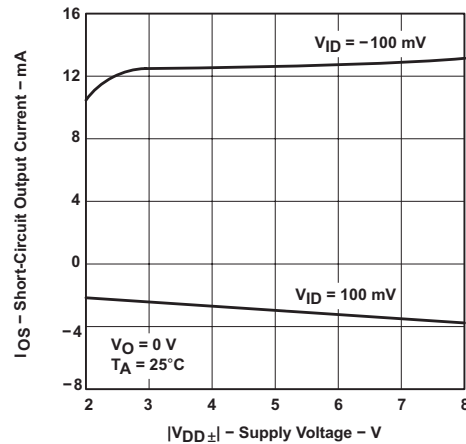

Figure 16. Short-Circuit Output Current vs Supply Voltage

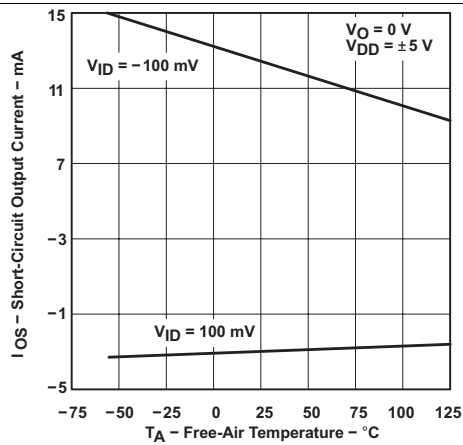

Figure 17. Short-Circuit Output Current vs Ambient Temperature

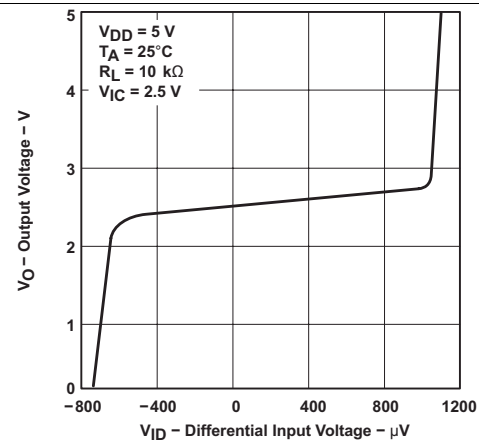

Figure 18. Output Voltage vs Differential Input Voltage

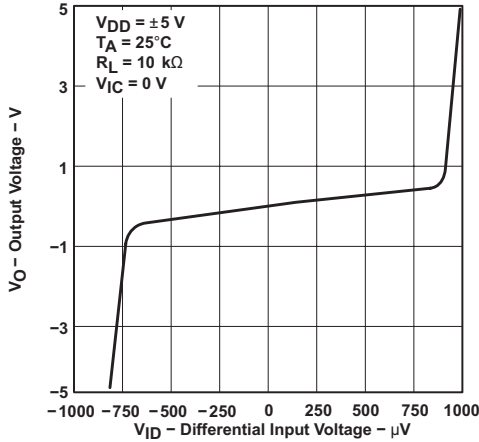

Figure 19. Output Voltage vs Differential Input Voltage

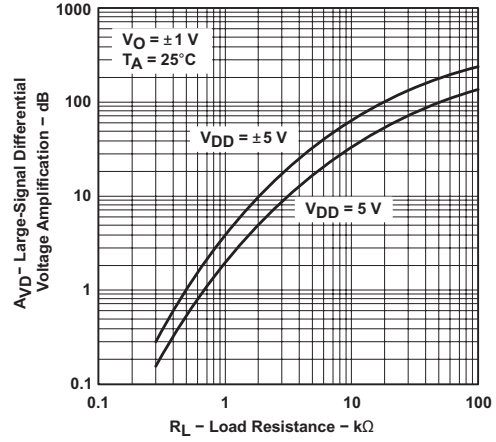

Figure 20. Large-Signal Differential Voltage Amplification vs Load Resistance

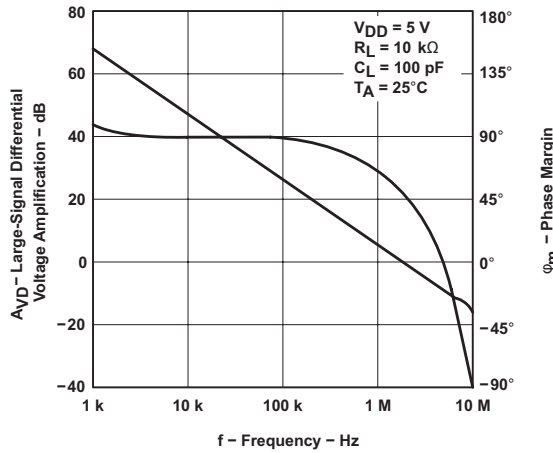

Figure 21. Large-Signal Differential Voltage Amplification and Phase Margin vs Frequency

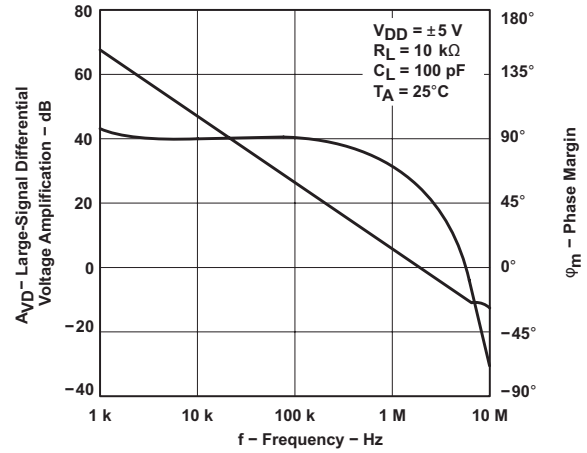

Figure 22. Large-Signal Differential Voltage Amplification and Phase Margin vs Frequency

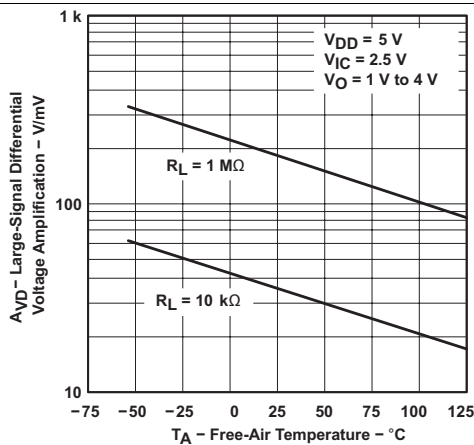

Figure 23. Large-Signal Differential Voltage Amplification vs Ambient Temperature

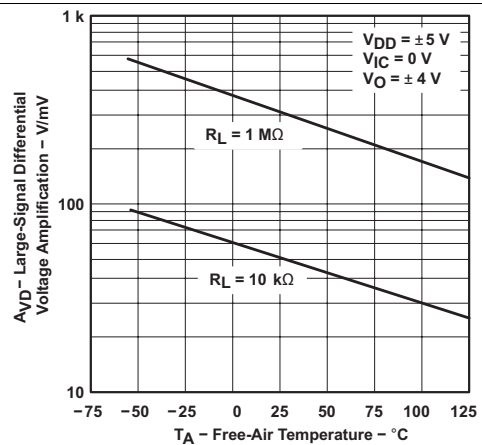

Figure 24. Large-Signal Differential Voltage Amplification vs Ambient Temperature

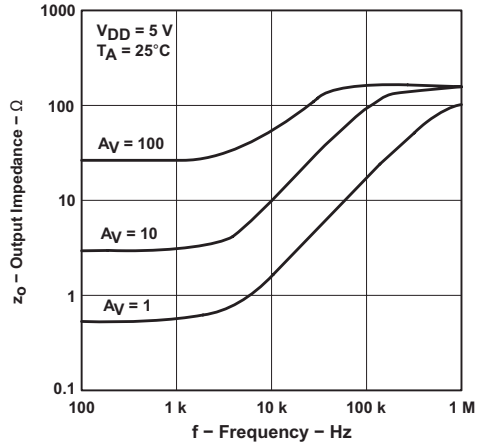

Figure 25. Output Impedance vs Frequency

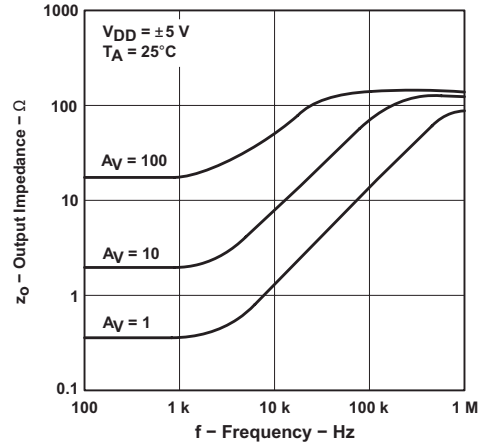

Figure 26. Output Impedance vs Frequency

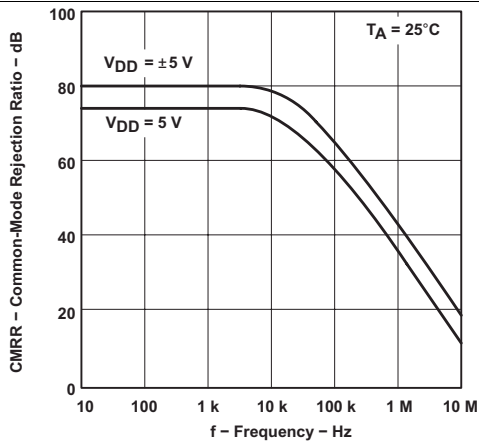

Figure 27. Common-Mode Rejection Ratio vs Frequency

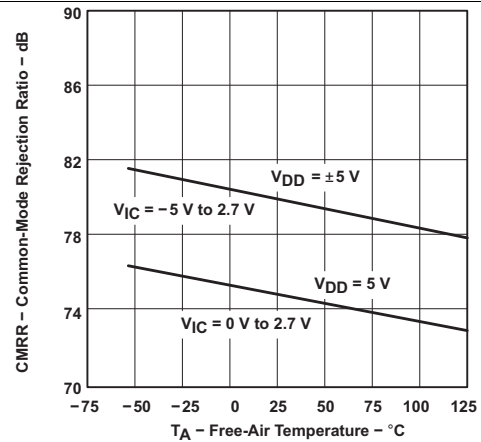

Figure 28. Common-Mode Rejection Ratio vs Ambient Temperature

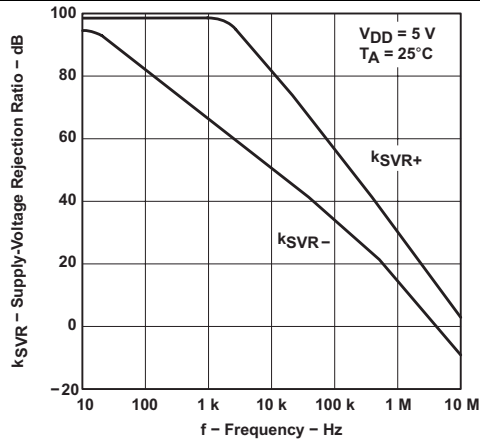

Figure 29. Supply-Voltage Rejection Ratio vs Frequency

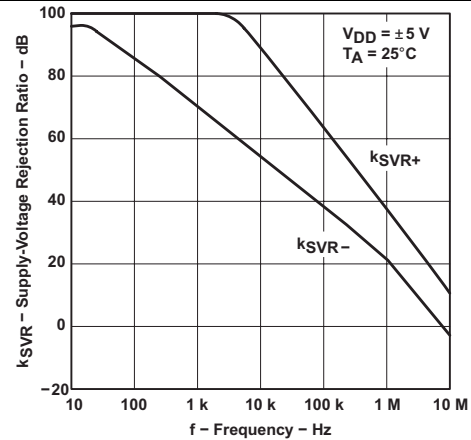

Figure 30. Supply-Voltage Rejection Ratio vs Frequency

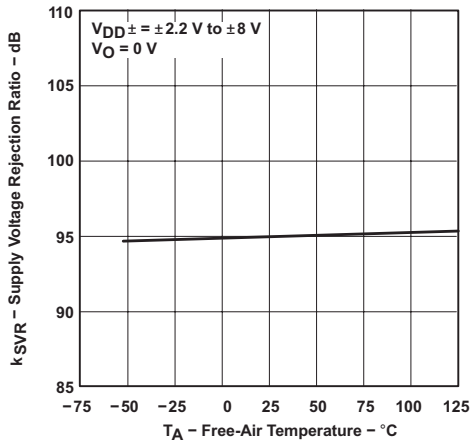

Figure 31. Supply-Voltage Rejection Ratio vs Ambient Temperature

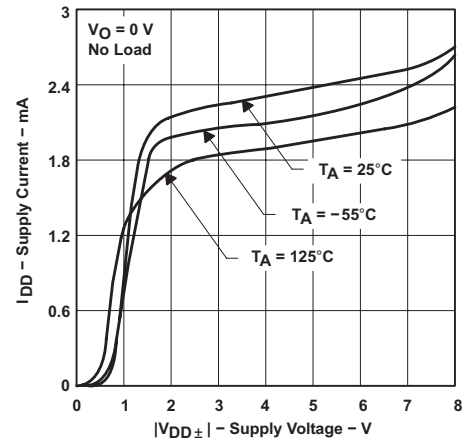

Figure 32. Supply Current vs Supply Voltage

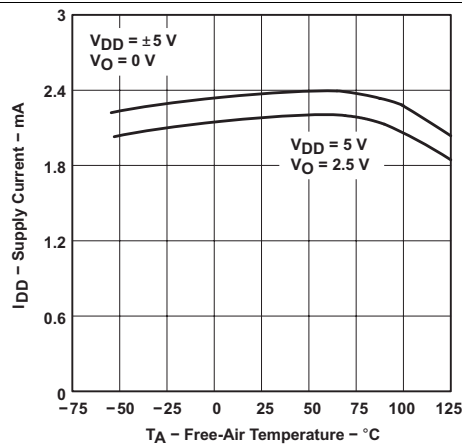

Figure 33. Supply Current vs Ambient Temperature

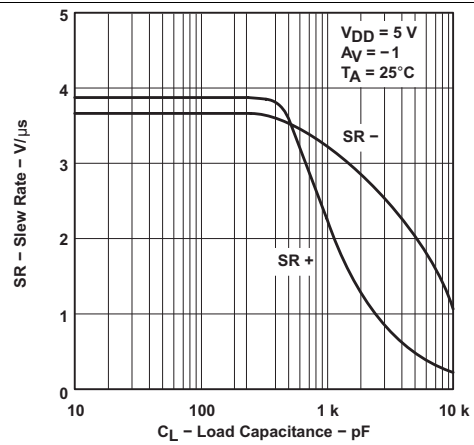

Figure 34. Slew Rate vs Load Capacitance

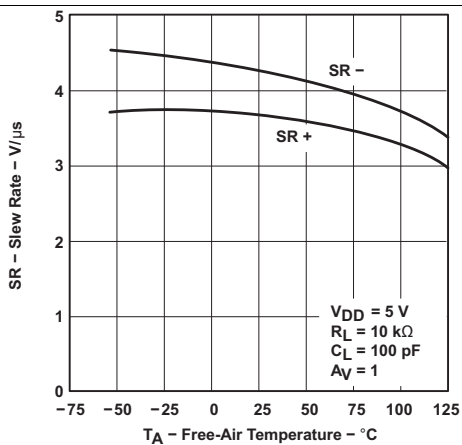

Figure 35. Slew Rate vs Ambient Temperature

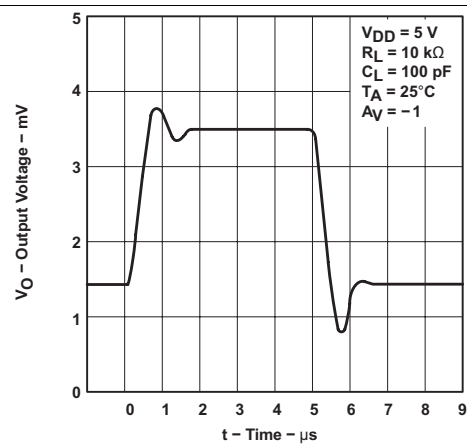

Figure 36. Inverting Large-Signal Pulse Response

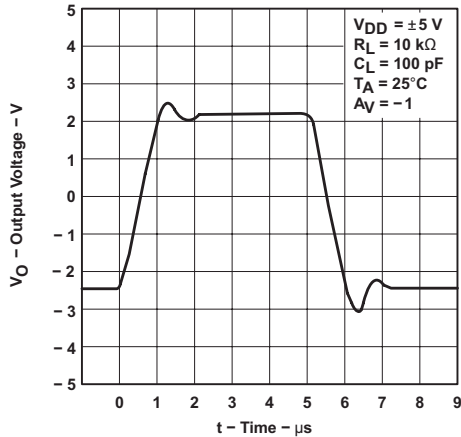

Figure 37. Inverting Large-Signal Pulse Response

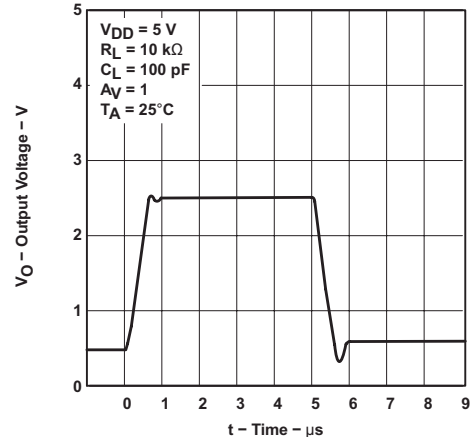

Figure 38. Voltage-Follower Large-Signal Pulse Response

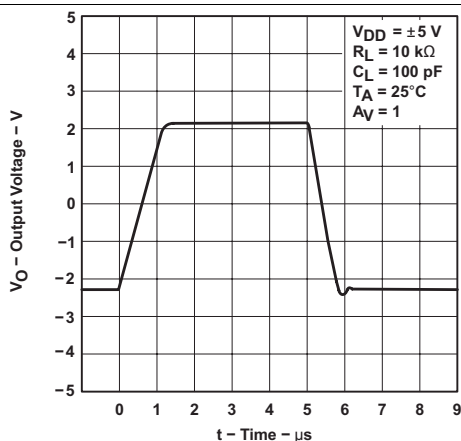

Figure 39. Voltage-Follower Large-Signal Pulse Response

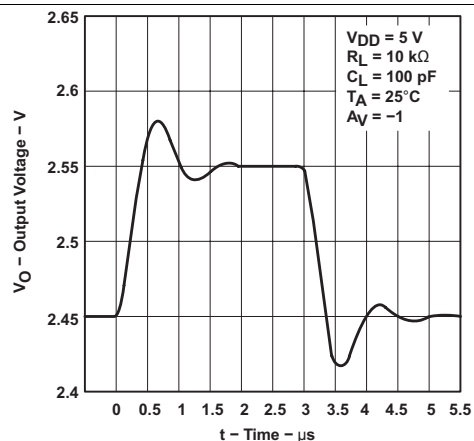

Figure 40. Inverting Small-Signal Pulse Response

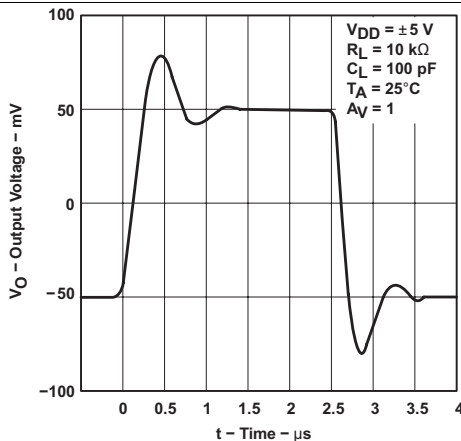

Figure 41. Inverting Small-Signal Pulse Response

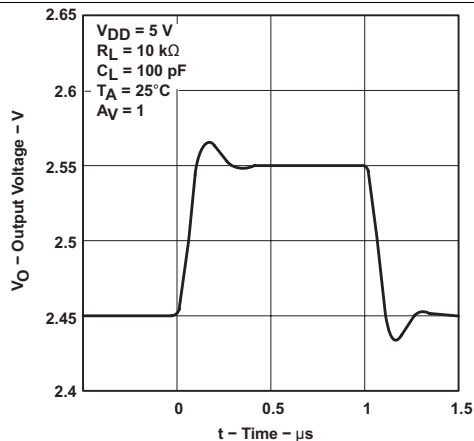

Figure 42. Voltage-Follower Small-Signal Pulse Response

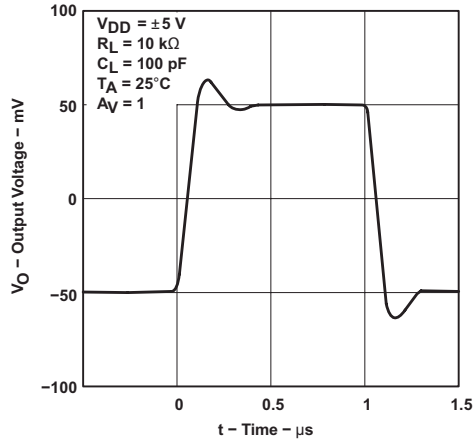

Figure 43. Voltage-Follower Small-Signal Pulse Response

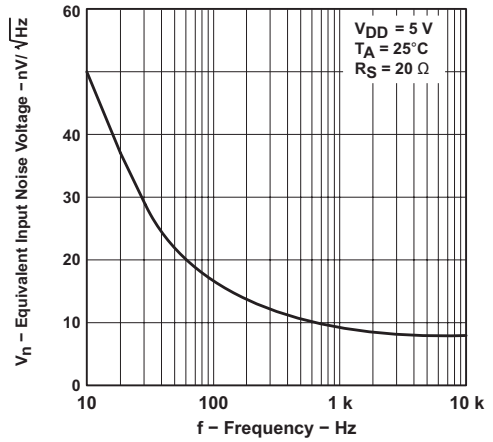

Figure 44. Equivalent Input Noise Voltage vs Frequency

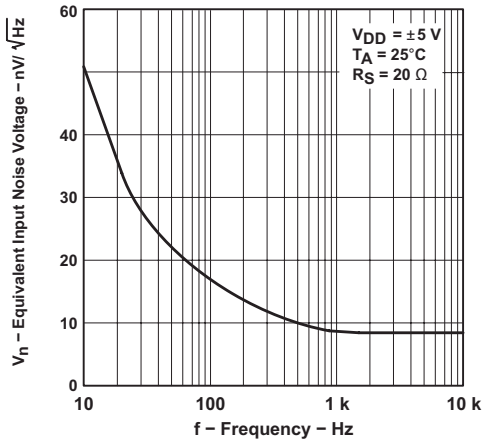

Figure 45. Equivalent Input Noise Voltage vs Frequency

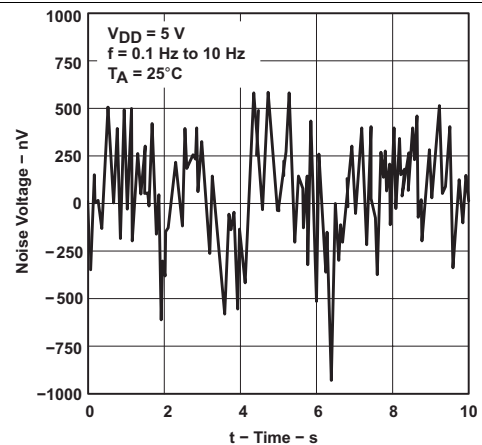

Figure 46. Noise Voltage Over a 10-Second Period

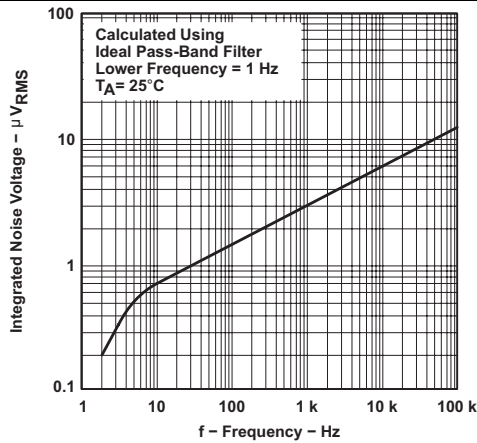

Figure 47. Integrated Noise Voltage vs Frequency

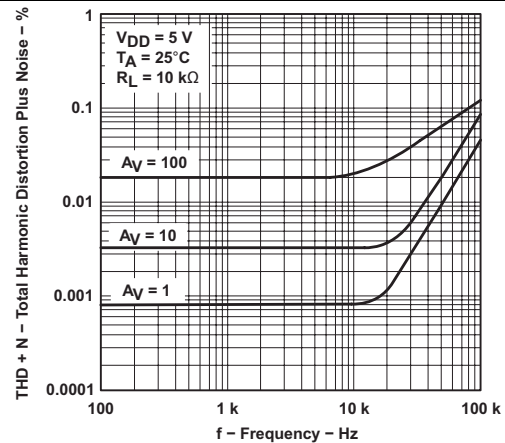

Figure 48. Total Harmonic Distortion + Noise vs Frequency

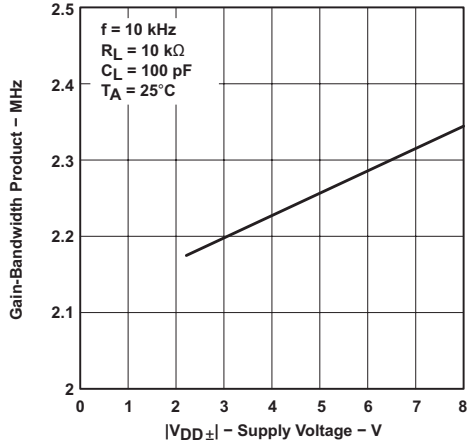

Figure 49. Gain-Bandwidth Product vs Supply Voltage

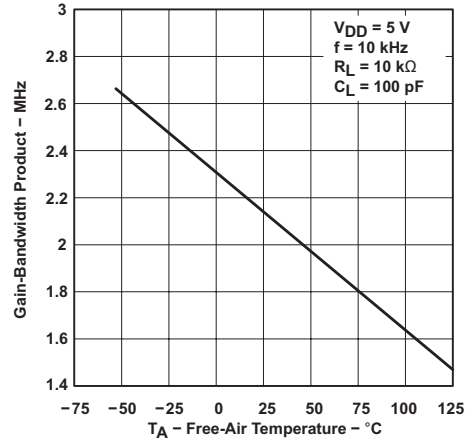

Figure 50. Gain-Bandwidth Product vs Ambient Temperature

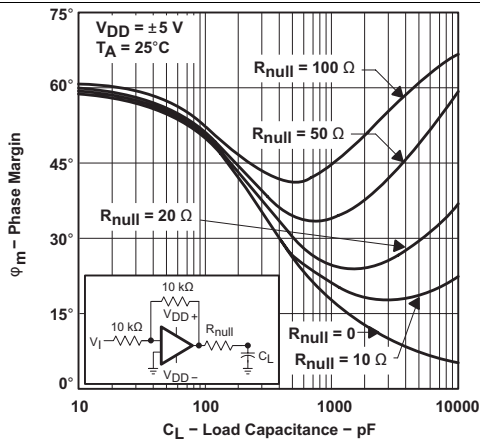

Figure 51. Phase Margin vs Load Capacitance

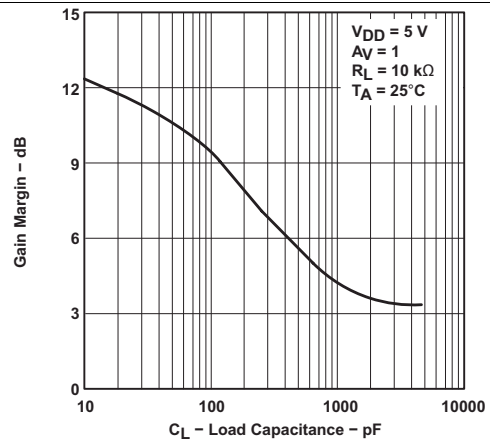

Figure 52. Gain Margin vs Load Capacitance

7 Detailed Description

7.1 Overview

The TLC2272M-MIL device is a rail-to-rail output operational amplifier. The device operates from a 4.4-V to 16-V single supply or ± 2.2 -V to ± 8 -V dual supply, is unity-gain stable, and is suitable for a wide range of general-purpose applications.

7.2 Functional Block Diagram

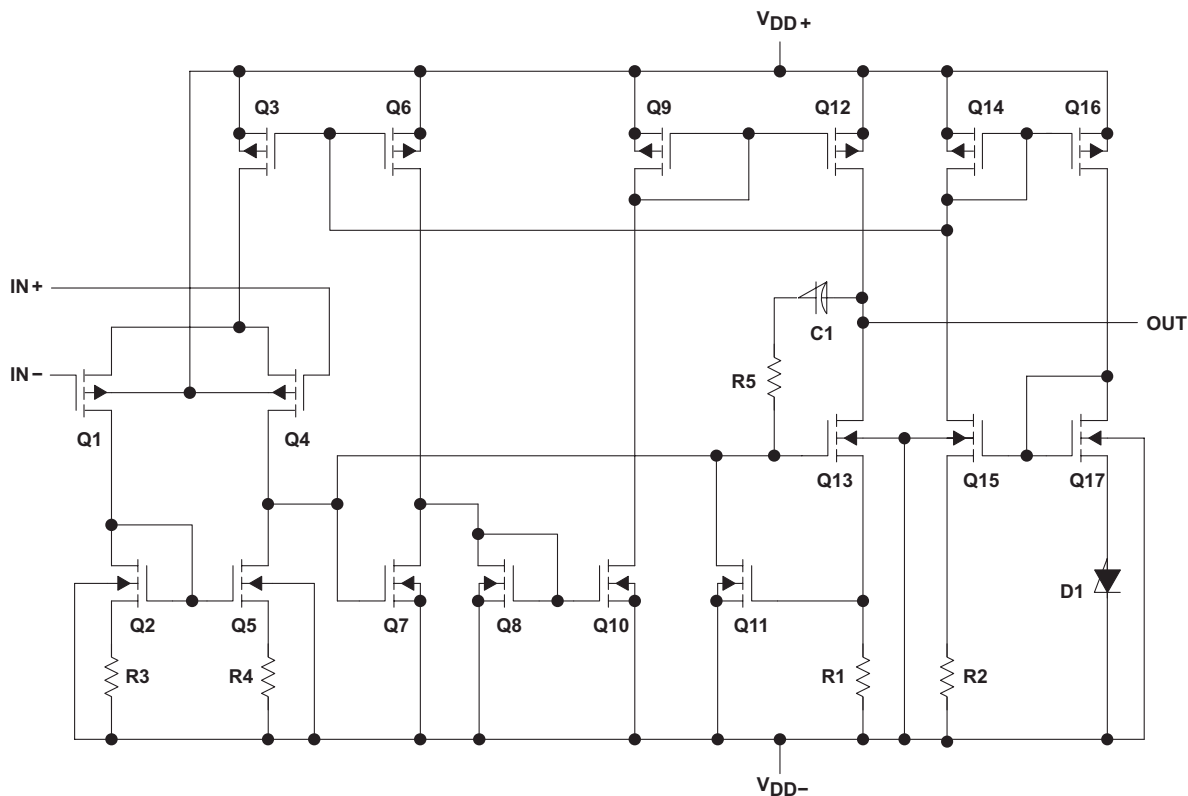

Table 2. Device Component Count⁽¹⁾

COMPONENT	COUNT
Transistors	38
Resistors	26
Diodes	9
Capacitors	3

(1) Includes both amplifiers and all ESD, bias, and trim circuitry.

7.3 Feature Description

The TLC2272M-MIL device features 2-MHz bandwidth and voltage noise of $9 \text{ nV}/\sqrt{\text{Hz}}$ with performance rated from 4.4 V to 16 V across a temperature range of -55°C to 125°C). LinMOS suits a wide range of audio, automotive, industrial, and instrumentation applications.

7.4 Device Functional Modes

The TLC2272M-MIL device is powered on when the supply is connected. The device may operate with single or dual supply, depending on the application. The device is in its full-performance mode once the supply is above the recommended value.

8 Application and Implementation

NOTE

Information in the following applications sections is not part of the TI component specification, and TI does not warrant its accuracy or completeness. TI's customers are responsible for determining suitability of components for their purposes. Customers should validate and test their design implementation to confirm system functionality.

8.1 Application Information

8.1.1 Macromodel Information

Macromodel information provided was derived using MicroSim Parts™, the model generation software used with MicroSim PSpice™. The Boyle macromodel ⁽¹⁾ and subcircuit in Figure 53 were generated using the TLC2272M-MIL typical electrical and operating characteristics at $T_A = 25^\circ\text{C}$. Using this information, output simulations of the following key parameters can be generated to a tolerance of 20% (in most cases):

- Maximum positive output voltage swing
- Maximum negative output voltage swing
- Slew rate
- Quiescent power dissipation
- Input bias current
- Open-loop voltage amplification
- Unity-gain frequency
- Common-mode rejection ratio
- Phase margin
- DC output resistance
- AC output resistance
- Short-circuit output current limit

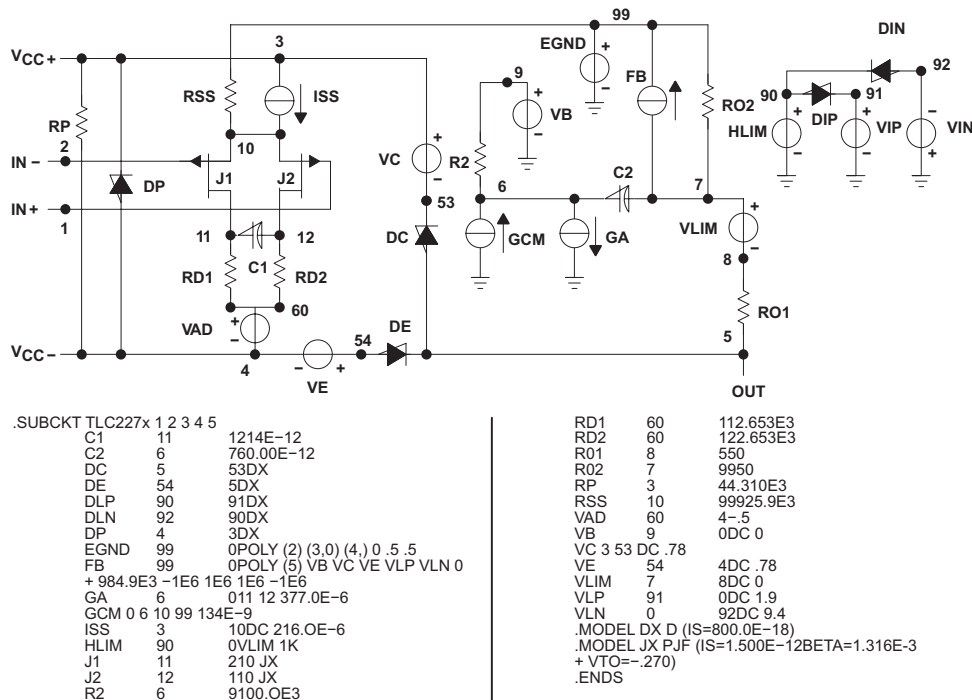

Figure 53. Boyle Macromodel and Subcircuit

(1) *Macromodeling of Integrated Circuit Operational Amplifiers*, IEEE Journal of Solid-State Circuits, SC-9, 353 (1974).

8.2 Typical Application

8.2.1 High-Side Current Monitor

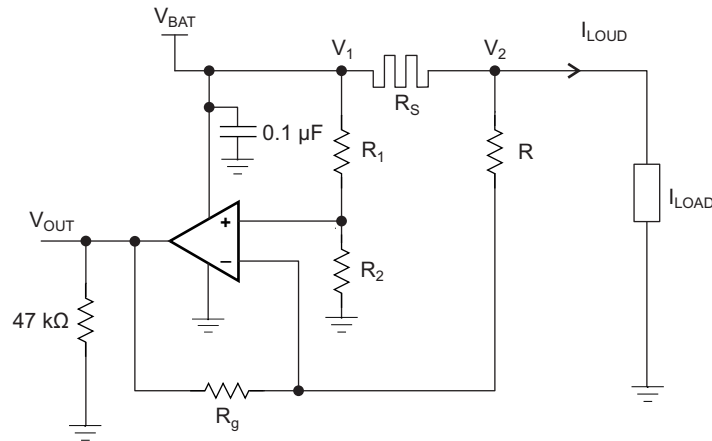

Figure 54. Equivalent Schematic (Each Amplifier)

8.2.1.1 Design Requirements

For this design example, use the parameters listed in [Table 3](#) as the input parameters.

Table 3. Design Parameters

PARAMETER	VALUE
V_{BAT}	Battery voltage 12 V
R_{SENSE}	Sense resistor 0.1 Ω
I_{LOAD}	Load current 0 A to 10 A
Operational amplifier	Set in differential configuration with gain = 10

8.2.1.2 Detailed Design Procedure

This circuit is designed for measuring the high-side current in automotive body control modules with a 12-V battery or similar applications. The operational amplifier is set as differential with an external resistor network.

8.2.1.2.1 Differential Amplifier Equations

[Equation 1](#) and [Equation 2](#) are used to calculate V_{OUT} .

$$V_{OUT} = \frac{R_g}{R} \left(\frac{\frac{R}{R_g} - \frac{R_1}{R_2}}{1 + \frac{R_1}{R_2}} \times \frac{V_1 + V_2}{2} + \frac{1 + \frac{1}{2} \left(\frac{R_1}{R_2} + \frac{R}{R_g} \right)}{1 + \frac{R_1}{R_2}} (V_1 - V_2) \right) \quad (1)$$

$$V_{OUT} = \frac{R_g}{R} \left(\frac{\frac{R}{R_g} - \frac{R_1}{R_2}}{1 + \frac{R_1}{R_2}} \times V_{BAT} + \frac{1 + \frac{1}{2} \left(\frac{R_1}{R_2} + \frac{R}{R_g} \right)}{1 + \frac{R_1}{R_2}} \times R_S \times I_{LOAD} \right) \quad (2)$$

In an ideal case $R_1 = R$ and $R_2 = R_g$, and V_{OUT} can then be calculated using [Equation 3](#):

$$V_{OUT} = \frac{R_g}{R} \times R_S \times I_{LOAD} \quad (3)$$

However, as the resistors have tolerances, they cannot be perfectly matched.

$$\begin{aligned}
 R_1 &= R \pm \Delta R_1 \\
 R_2 &= R_2 \pm \Delta R_2 \\
 R &= R \pm \Delta R \\
 R_g &= R_g \pm \Delta R_g \\
 \text{Tol} &= \frac{\Delta R}{R}
 \end{aligned}
 \tag{4}$$

By developing the equations and neglecting the second order, the worst case is when the tolerances add up. This is shown by [Equation 5](#).

$$V_{\text{OUT}} = \pm (4 \text{ Tol}) \frac{R_g}{R + R_g} \times V_{\text{BAT}} + \left(1 \pm 2 \text{ Tol} \left(1 + \frac{2R}{R + R_g} \right) \right) \frac{R_g}{R} \times R_S \times I_{\text{LOAD}}$$

where

- Tol = 0.01 for 1%
 - Tol = 0.001 for 0.1%
- (5)

If the resistors are perfectly matched, then Tol = 0 and V_{OUT} is calculated using [Equation 6](#).

$$V_{\text{OUT}} = \frac{R_g}{R} \times R_S \times I_{\text{LOAD}}
 \tag{6}$$

The highest error is from the common mode, as shown in [Equation 7](#).

$$4 (\text{Tol}) \frac{R_g}{R + R_g} \times V_{\text{BAT}}
 \tag{7}$$

Gain of 10, $R_g / R = 10$, and Tol = 1%:

$$\text{Common mode error} = ((4 \times 0.01) / 1.1) \times 12 \text{ V} = 0.436 \text{ V}$$

Gain of 10 and Tol = 0.1%:

$$\text{Common mode error} = 43.6 \text{ mV}$$

The resistors were chosen from 2% batches.

R_1 and R 12 k Ω

R_2 and R_g 120 k Ω

Ideal Gain = 120 / 12 = 10

The measured value of the resistors:

$R_1 = 11.835 \text{ k}\Omega$

R = 11.85 k Ω

$R_2 = 117.92 \text{ k}\Omega$

$R_g = 118.07 \text{ k}\Omega$

8.2.1.3 Application Curves

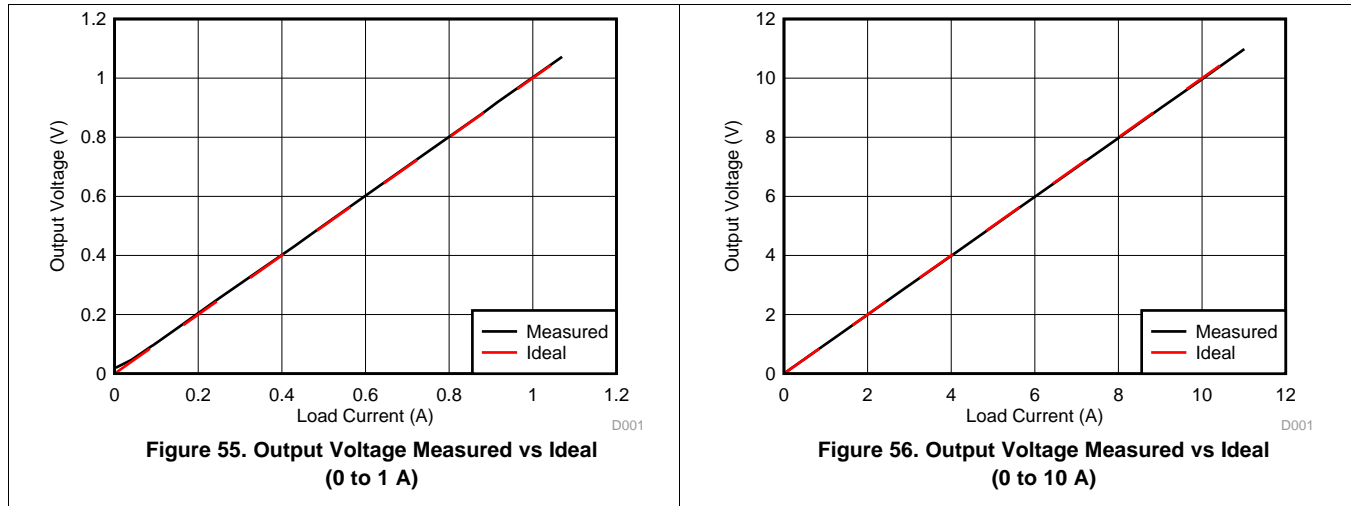

9 Power Supply Recommendations

Supply voltage for a single supply is from 4.4 V to 16 V, and from ± 2.2 V to ± 8 V for a dual supply. In the high-side sensing application, the supply is connected to a 12-V battery.

10 Layout

10.1 Layout Guidelines

The TLC2272M-MIL device is a wideband amplifier. To realize the full operational performance of the device, good high-frequency printed-circuit-board (PCB) layout practices are required. Low-loss 0.1- μ F bypass capacitors must be connected between each supply pin and ground as close to the device as possible. The bypass capacitor traces should be designed for minimum inductance.

10.2 Layout Example

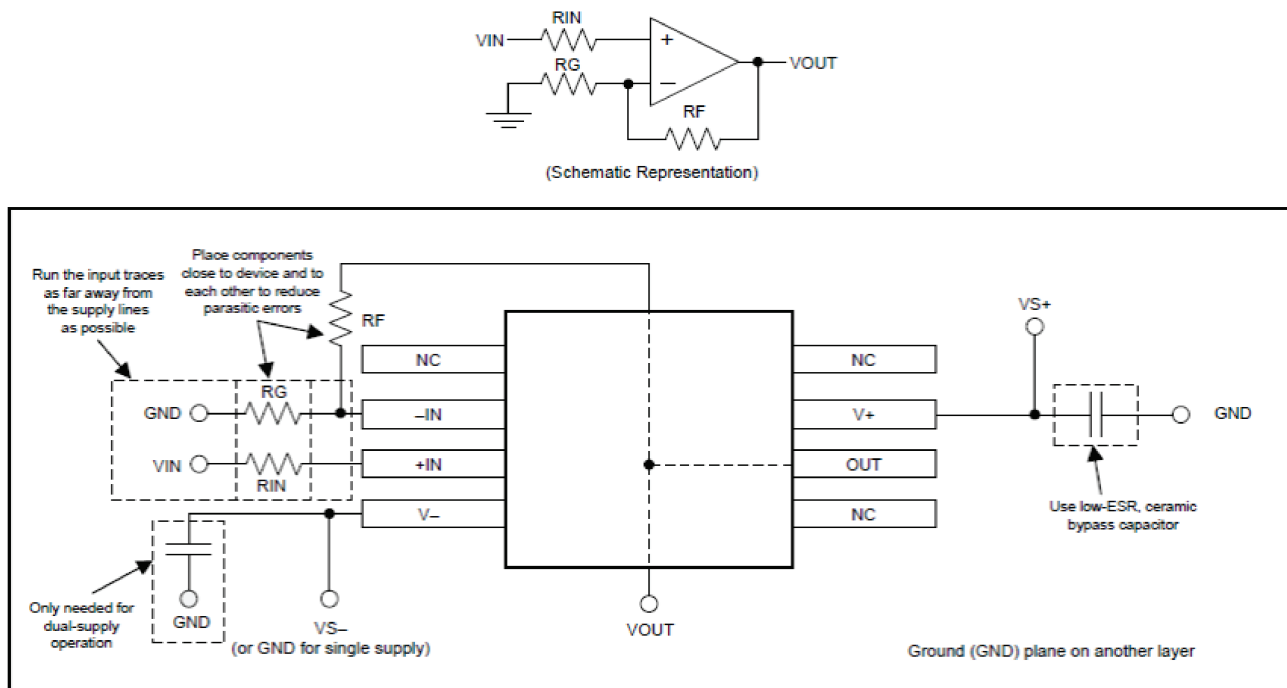

Figure 57. Layout Example

11 Device and Documentation Support

11.1 Receiving Notification of Documentation Updates

To receive notification of documentation updates, navigate to the device product folder on ti.com. In the upper right corner, click on *Alert me* to register and receive a weekly digest of any product information that has changed. For change details, review the revision history included in any revised document.

11.2 Community Resources

The following links connect to TI community resources. Linked contents are provided "AS IS" by the respective contributors. They do not constitute TI specifications and do not necessarily reflect TI's views; see TI's [Terms of Use](#).

TI E2E™ Online Community *TI's Engineer-to-Engineer (E2E) Community*. Created to foster collaboration among engineers. At e2e.ti.com, you can ask questions, share knowledge, explore ideas and help solve problems with fellow engineers.

Design Support *TI's Design Support* Quickly find helpful E2E forums along with design support tools and contact information for technical support.

11.3 Trademarks

E2E is a trademark of Texas Instruments.
MicroSim Parts, PSpice are trademarks of MicroSim.
All other trademarks are the property of their respective owners.

11.4 Electrostatic Discharge Caution



These devices have limited built-in ESD protection. The leads should be shorted together or the device placed in conductive foam during storage or handling to prevent electrostatic damage to the MOS gates.

11.5 Glossary

[SLYZ022](#) — *TI Glossary*.

This glossary lists and explains terms, acronyms, and definitions.

12 Mechanical, Packaging, and Orderable Information

The following pages include mechanical, packaging, and orderable information. This information is the most current data available for the designated devices. This data is subject to change without notice and revision of this document. For browser-based versions of this data sheet, refer to the left-hand navigation.

PACKAGING INFORMATION

Orderable Device	Status (1)	Package Type	Package Drawing	Pins	Package Qty	Eco Plan (2)	Lead/Ball Finish (6)	MSL Peak Temp (3)	Op Temp (°C)	Device Marking (4/5)	Samples
5962-9555201NXD	ACTIVE	SOIC	D	8	2500	Green (RoHS & no Sb/Br)	NIPDAU	Level-1-260C-UNLIM	-55 to 125	Q2272M	Samples
5962-9555201NXDR	ACTIVE	SOIC	D	8	2500	Green (RoHS & no Sb/Br)	NIPDAU	Level-1-260C-UNLIM	-55 to 125	Q2272M	Samples
5962-9555201Q2A	ACTIVE	LCCC	FK	20	1	TBD	POST-PLATE	N / A for Pkg Type	-55 to 125	5962-9555201Q2A TLC2272 MFKB	Samples
5962-9555201QHA	ACTIVE	CFP	U	10	1	TBD	Call TI	N / A for Pkg Type	-55 to 125	9555201QHA TLC2272M	Samples
5962-9555201QPA	ACTIVE	CDIP	JG	8	1	TBD	Call TI	N / A for Pkg Type	-55 to 125	9555201QPA TLC2272M	Samples
TLC2272MFKB	ACTIVE	LCCC	FK	20	1	TBD	POST-PLATE	N / A for Pkg Type	-55 to 125	5962-9555201Q2A TLC2272 MFKB	Samples
TLC2272MJG	ACTIVE	CDIP	JG	8	1	TBD	Call TI	N / A for Pkg Type	-55 to 125	TLC2272MJG	Samples
TLC2272MJGB	ACTIVE	CDIP	JG	8	1	TBD	Call TI	N / A for Pkg Type	-55 to 125	9555201QPA TLC2272M	Samples
TLC2272MUB	ACTIVE	CFP	U	10	1	TBD	Call TI	N / A for Pkg Type	-55 to 125	9555201QHA TLC2272M	Samples

(1) The marketing status values are defined as follows:

ACTIVE: Product device recommended for new designs.

LIFEBUY: TI has announced that the device will be discontinued, and a lifetime-buy period is in effect.

NRND: Not recommended for new designs. Device is in production to support existing customers, but TI does not recommend using this part in a new design.

PREVIEW: Device has been announced but is not in production. Samples may or may not be available.

OBSOLETE: TI has discontinued the production of the device.

(2) **RoHS:** TI defines "RoHS" to mean semiconductor products that are compliant with the current EU RoHS requirements for all 10 RoHS substances, including the requirement that RoHS substance do not exceed 0.1% by weight in homogeneous materials. Where designed to be soldered at high temperatures, "RoHS" products are suitable for use in specified lead-free processes. TI may reference these types of products as "Pb-Free".

RoHS Exempt: TI defines "RoHS Exempt" to mean products that contain lead but are compliant with EU RoHS pursuant to a specific EU RoHS exemption.

Green: TI defines "Green" to mean the content of Chlorine (Cl) and Bromine (Br) based flame retardants meet JS709B low halogen requirements of <=1000ppm threshold. Antimony trioxide based flame retardants must also meet the <=1000ppm threshold requirement.

- (3) MSL, Peak Temp. - The Moisture Sensitivity Level rating according to the JEDEC industry standard classifications, and peak solder temperature.
- (4) There may be additional marking, which relates to the logo, the lot trace code information, or the environmental category on the device.
- (5) Multiple Device Markings will be inside parentheses. Only one Device Marking contained in parentheses and separated by a "-" will appear on a device. If a line is indented then it is a continuation of the previous line and the two combined represent the entire Device Marking for that device.
- (6) Lead/Ball Finish - Orderable Devices may have multiple material finish options. Finish options are separated by a vertical ruled line. Lead/Ball Finish values may wrap to two lines if the finish value exceeds the maximum column width.

Important Information and Disclaimer:The information provided on this page represents TI's knowledge and belief as of the date that it is provided. TI bases its knowledge and belief on information provided by third parties, and makes no representation or warranty as to the accuracy of such information. Efforts are underway to better integrate information from third parties. TI has taken and continues to take reasonable steps to provide representative and accurate information but may not have conducted destructive testing or chemical analysis on incoming materials and chemicals. TI and TI suppliers consider certain information to be proprietary, and thus CAS numbers and other limited information may not be available for release.

In no event shall TI's liability arising out of such information exceed the total purchase price of the TI part(s) at issue in this document sold by TI to Customer on an annual basis.

TAPE AND REEL INFORMATION



QUADRANT ASSIGNMENTS FOR PIN 1 ORIENTATION IN TAPE



*All dimensions are nominal

Device	Package Type	Package Drawing	Pins	SPQ	Reel Diameter (mm)	Reel Width W1 (mm)	A0 (mm)	B0 (mm)	K0 (mm)	P1 (mm)	W (mm)	Pin1 Quadrant
5962-9555201NXDR	SOIC	D	8	2500	330.0	12.4	6.4	5.2	2.1	8.0	12.0	Q1

TAPE AND REEL BOX DIMENSIONS



*All dimensions are nominal

Device	Package Type	Package Drawing	Pins	SPQ	Length (mm)	Width (mm)	Height (mm)
5962-9555201NXDR	SOIC	D	8	2500	350.0	350.0	43.0



D0008A

PACKAGE OUTLINE

SOIC - 1.75 mm max height

SMALL OUTLINE INTEGRATED CIRCUIT



4214825/C 02/2019

NOTES:

- Linear dimensions are in inches [millimeters]. Dimensions in parenthesis are for reference only. Controlling dimensions are in inches. Dimensioning and tolerancing per ASME Y14.5M.
- This drawing is subject to change without notice.
- This dimension does not include mold flash, protrusions, or gate burrs. Mold flash, protrusions, or gate burrs shall not exceed $.006$ [0.15] per side.
- This dimension does not include interlead flash.
- Reference JEDEC registration MS-012, variation AA.

EXAMPLE BOARD LAYOUT

D0008A

SOIC - 1.75 mm max height

SMALL OUTLINE INTEGRATED CIRCUIT



LAND PATTERN EXAMPLE
 EXPOSED METAL SHOWN
 SCALE:8X



SOLDER MASK DETAILS

4214825/C 02/2019

NOTES: (continued)

- 6. Publication IPC-7351 may have alternate designs.
- 7. Solder mask tolerances between and around signal pads can vary based on board fabrication site.

EXAMPLE STENCIL DESIGN

D0008A

SOIC - 1.75 mm max height

SMALL OUTLINE INTEGRATED CIRCUIT



SOLDER PASTE EXAMPLE
BASED ON .005 INCH [0.125 MM] THICK STENCIL
SCALE:8X

4214825/C 02/2019

NOTES: (continued)

8. Laser cutting apertures with trapezoidal walls and rounded corners may offer better paste release. IPC-7525 may have alternate design recommendations.
9. Board assembly site may have different recommendations for stencil design.

JG (R-GDIP-T8)

CERAMIC DUAL-IN-LINE

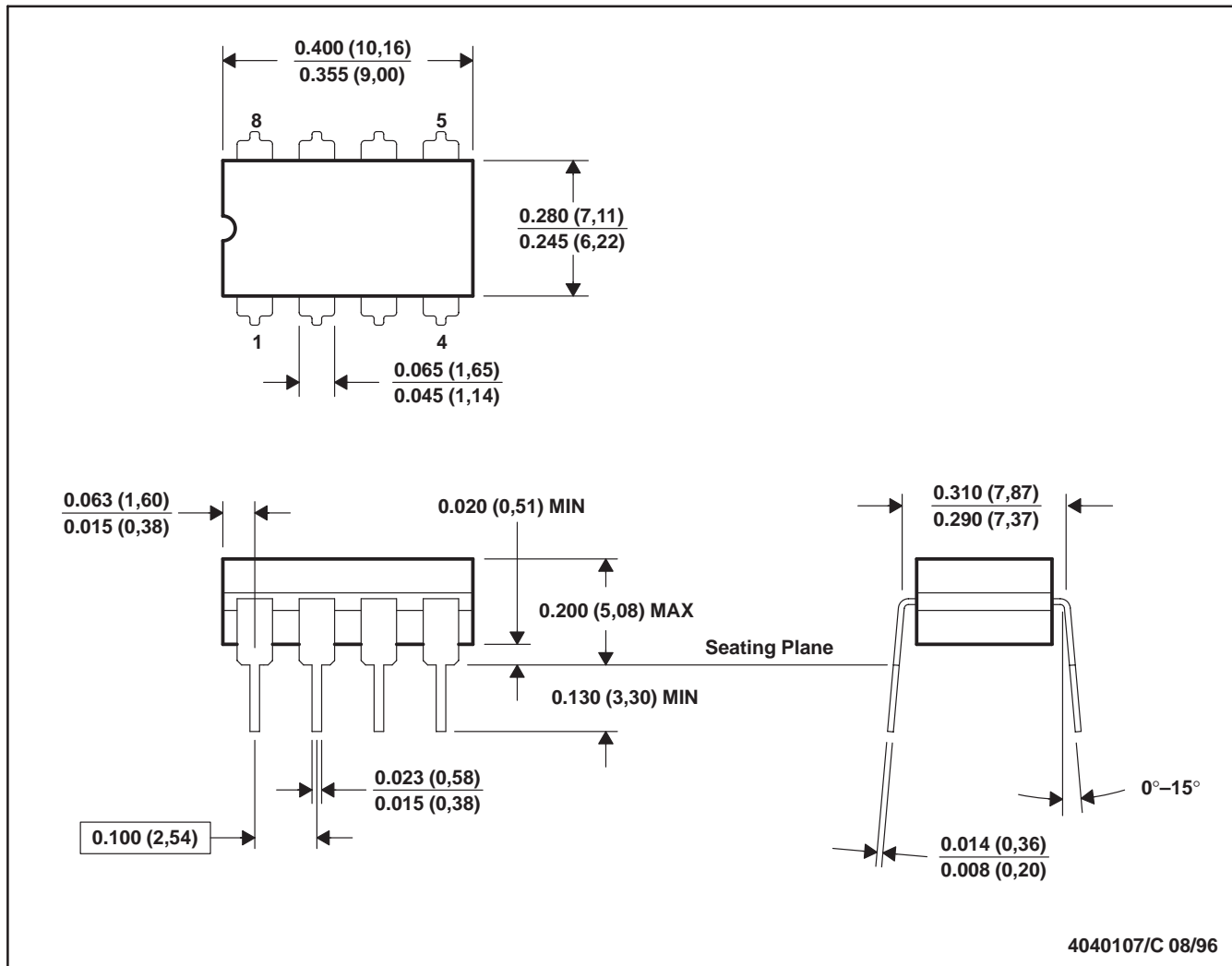

- NOTES: A. All linear dimensions are in inches (millimeters).
 B. This drawing is subject to change without notice.
 C. This package can be hermetically sealed with a ceramic lid using glass frit.
 D. Index point is provided on cap for terminal identification.
 E. Falls within MIL STD 1835 GDIP1-T8

U0010A



PACKAGE OUTLINE

CFP - 2.03 mm max height

CERAMIC FLATPACK

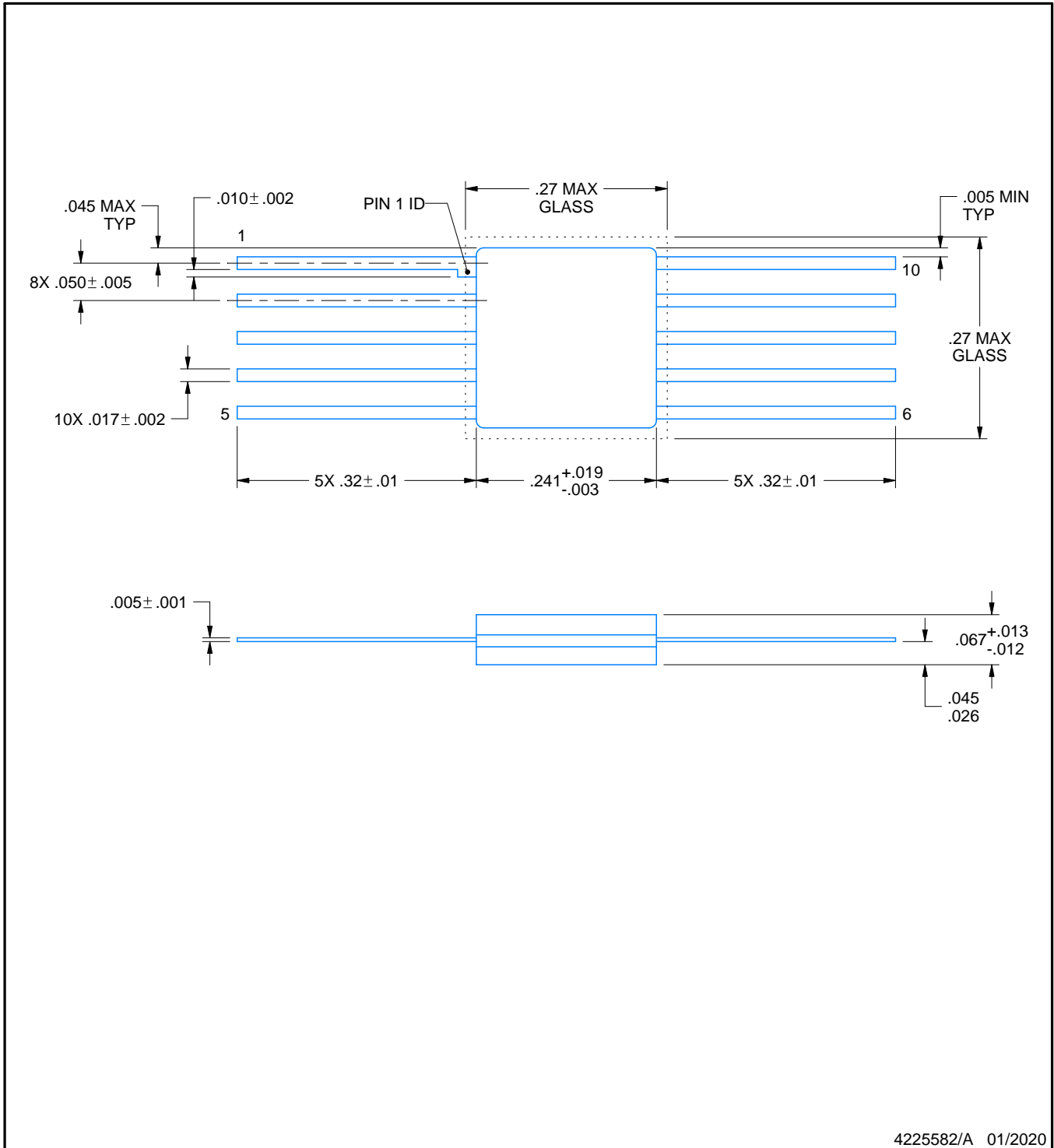

4225582/A 01/2020

NOTES:

1. All linear dimensions are in inches. Any dimensions in parenthesis are for reference only. Dimensioning and tolerancing per ASME Y14.5M.
2. This drawing is subject to change without notice.

FK (S-CQCC-N**)

LEADLESS CERAMIC CHIP CARRIER

28 TERMINAL SHOWN



NO. OF TERMINALS **	A		B	
	MIN	MAX	MIN	MAX
20	0.342 (8,69)	0.358 (9,09)	0.307 (7,80)	0.358 (9,09)
28	0.442 (11,23)	0.458 (11,63)	0.406 (10,31)	0.458 (11,63)
44	0.640 (16,26)	0.660 (16,76)	0.495 (12,58)	0.560 (14,22)
52	0.740 (18,78)	0.761 (19,32)	0.495 (12,58)	0.560 (14,22)
68	0.938 (23,83)	0.962 (24,43)	0.850 (21,6)	0.858 (21,8)
84	1.141 (28,99)	1.165 (29,59)	1.047 (26,6)	1.063 (27,0)

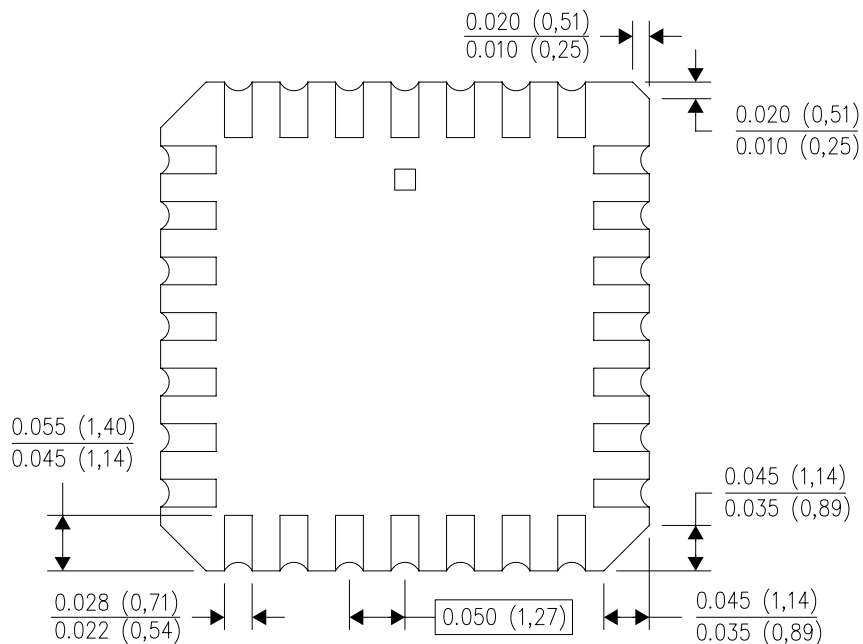

4040140/D 01/11

- NOTES:
- A. All linear dimensions are in inches (millimeters).
 - B. This drawing is subject to change without notice.
 - C. This package can be hermetically sealed with a metal lid.
 - D. Falls within JEDEC MS-004

IMPORTANT NOTICE AND DISCLAIMER

TI PROVIDES TECHNICAL AND RELIABILITY DATA (INCLUDING DATASHEETS), DESIGN RESOURCES (INCLUDING REFERENCE DESIGNS), APPLICATION OR OTHER DESIGN ADVICE, WEB TOOLS, SAFETY INFORMATION, AND OTHER RESOURCES "AS IS" AND WITH ALL FAULTS, AND DISCLAIMS ALL WARRANTIES, EXPRESS AND IMPLIED, INCLUDING WITHOUT LIMITATION ANY IMPLIED WARRANTIES OF MERCHANTABILITY, FITNESS FOR A PARTICULAR PURPOSE OR NON-INFRINGEMENT OF THIRD PARTY INTELLECTUAL PROPERTY RIGHTS.

These resources are intended for skilled developers designing with TI products. You are solely responsible for (1) selecting the appropriate TI products for your application, (2) designing, validating and testing your application, and (3) ensuring your application meets applicable standards, and any other safety, security, or other requirements. These resources are subject to change without notice. TI grants you permission to use these resources only for development of an application that uses the TI products described in the resource. Other reproduction and display of these resources is prohibited. No license is granted to any other TI intellectual property right or to any third party intellectual property right. TI disclaims responsibility for, and you will fully indemnify TI and its representatives against, any claims, damages, costs, losses, and liabilities arising out of your use of these resources.

TI's products are provided subject to TI's Terms of Sale (www.ti.com/legal/termsofsale.html) or other applicable terms available either on ti.com or provided in conjunction with such TI products. TI's provision of these resources does not expand or otherwise alter TI's applicable warranties or warranty disclaimers for TI products.

Mailing Address: Texas Instruments, Post Office Box 655303, Dallas, Texas 75265
Copyright © 2020, Texas Instruments Incorporated