

HA-2510, HA-2512, HA-2515

12MHz, High Input Impedance,
Operational Amplifiers

November 1996

Features

- Slew Rate 60V/ μ s
- Fast Settling 250ns
- Full Power Bandwidth 1MHz
- Gain Bandwidth 12MHz
- High Input Impedance 100M Ω
- Low Offset Current 10nA
- Internally Compensated for Unity Gain Stability

Applications

- Data Acquisition Systems
- RF Amplifiers
- Video Amplifiers
- Signal Generators
- Pulse Amplification

Description

HA-2510/12/15 are a series of high performance operational amplifiers which set the standards for maximum slew rate, highest accuracy and widest bandwidths for internally compensated devices. In addition to excellent dynamic characteristics, these dielectrically isolated amplifiers also offer low offset current and high input impedance.

The $\pm 60\text{V}/\mu\text{s}$ slew rate and 250ns (0.1%) settling time of these amplifiers is ideally suited for high speed D/A, A/D, and pulse amplification designs. HA-2510/12/15's superior 12MHz gain bandwidth and 1000kHz power bandwidth is extremely useful in RF and video applications. For accurate signal conditioning these amplifiers also provide 10nA offset current, coupled with 100M Ω input impedance, and offset trim capability.

MIL-STD-883 product and data sheets available upon request.

Ordering Information

PART NUMBER	TEMP. RANGE ($^{\circ}\text{C}$)	PACKAGE	PKG. NO.
HA2-2510-2	-55 to 125	8 Pin Metal Can	T8.C
HA2-2512-2	-55 to 125	8 Pin Metal Can	T8.C
HA2-2515-5	0 to 75	8 Pin Metal Can	T8.C
HA3-2515-5	0 to 75	8 Ld PDIP	E8.3
HA7-2510-2	-55 to 125	8 Ld CERDIP	F8.3A
HA7-2512-2	-55 to 125	8 Ld CERDIP	F8.3A
HA7-2515-5	0 to 75	8 Ld CERDIP	F8.3A

Pinouts

HA-2510/12 (CERDIP)
HA-2515 (PDIP, CERDIP)
TOP VIEW

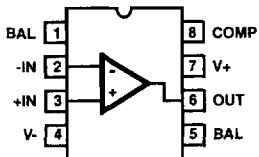

HA-2510/12/15
(METAL CAN)
TOP VIEW

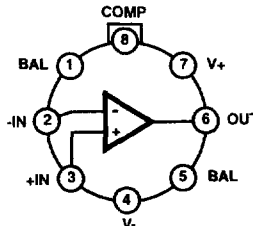

HA-2510, HA-2512, HA-2515

Absolute Maximum Ratings

Voltage Between V+ and V- Terminals	40V
Differential Input Voltage	15V
Peak Output Current	50mA

Operating Conditions

Temperature Range	
HA-2510/12-2	-55°C to 125°C
HA-2515-5	0°C to 75°C

Thermal Information

Thermal Resistance (Typical, Note 1)	θ_{JA} (°C/W)	θ_{JC} (°C/W)
Metal Can Package	165	80
PDIP Package	96	N/A
CERDIP Package	135	50
Maximum Junction Temperature (Hermetic Package)	175°C	
Maximum Junction Temperature (Plastic Package)	150°C	
Maximum Storage Temperature Range	-65°C to 150°C	
Maximum Lead Temperature (Soldering 10s)	300°C	

CAUTION: Stresses above those listed in "Absolute Maximum Ratings" may cause permanent damage to the device. This is a stress only rating and operation of the device at these or any other conditions above those indicated in the operational sections of this specification is not implied.

NOTE:

- θ_{JA} is measured with the component mounted on an evaluation PC board in free air.

Electrical Specifications $V_{SUPPLY} = \pm 15V$

PARAMETER	TEMP (°C)	HA-2510-2			HA-2512-2			HA-2515-5			UNITS
		MIN	TYP	MAX	MIN	TYP	MAX	MIN	TYP	MAX	
INPUT CHARACTERISTICS											
Offset Voltage	25	-	4	8	-	5	10	-	5	10	mV
	Full	-	-	11	-	-	14	-	-	14	mV
Offset Voltage Average Drift	Full	-	20	-	-	25	-	-	30	-	$\mu V/^\circ C$
Bias Current	25	-	100	200	-	125	250	-	125	250	nA
	Full	-	-	400	-	-	500	-	-	500	nA
Offset Current	25	-	10	25	-	20	50	-	20	50	nA
	Full	-	-	50	-	-	100	-	-	100	nA
Input Resistance (Note 2)	25	50	100	-	40	100	-	40	100	-	M Ω
Common Mode Range	Full	± 10.0	-	-	± 10.0	-	-	± 10.0	-	-	V
TRANSFER CHARACTERISTICS											
Large Signal Voltage Gain (Notes 3, 6)	25	10	15	-	7.5	15	-	7.5	15	-	kV/V
	Full	7.5	-	-	5	-	-	5	-	-	kV/V
Common Mode Rejection Ratio (Note 4)	Full	80	90	-	74	90	-	74	90	-	dB
Gain Bandwidth Product (Note 5)	25	-	12	-	-	12	-	-	12	-	MHz
OUTPUT CHARACTERISTICS											
Output Voltage Swing (Note 3)	Full	± 10.0	± 12.0	-	± 10.0	± 12.0	-	± 10.0	± 12.0	-	V
Output Current (Note 6)	25	± 10	± 20	-	± 10	± 20	-	± 10	± 20	-	mA
Full Power Bandwidth (Notes 6, 11)	25	750	1000	-	600	1000	-	600	1000	-	kHz
TRANSIENT RESPONSE											
Rise Time (Notes 3, 7, 8, 9)	25	-	25	50	-	25	50	-	25	50	ns
Overshoot (Notes 3, 7, 8, 9)	25	-	25	40	-5	25	50	-	25	50	%
Slew Rate (Notes 3, 7, 9, 12)	25	± 50	± 65	-	± 40	± 60	-	± 40	± 60	-	V/ μs
Settling Time to 0.1% (Notes 3, 7, 9, 12)	25	-	0.25	-	-	0.25	-	-	0.25	-	μs

HA-2510, HA-2512, HA-2515

Electrical Specifications $V_{SUPPLY} = \pm 15V$ (Continued)

PARAMETER	TEMP (°C)	HA-2510-2			HA-2512-2			HA-2515-5			UNITS
		MIN	TYP	MAX	MIN	TYP	MAX	MIN	TYP	MAX	
POWER SUPPLY CHARACTERISTICS											
Supply Current	25	-	4	6	-	4	6	-	4	6	mA
Power Supply Rejection Ratio (Note 10)	Full	80	90	-	74	90	-	74	90	-	dB

NOTES:

- This parameter value is based on design calculations.
- $R_L = 2k\Omega$.
- $V_{CM} = \pm 10V$.
- $A_V > 10$.
- $V_O = \pm 10V$.
- $C_L = 50pF$.
- $V_O = \pm 200mV$.
- See Transient Response Test Circuits and Waveforms.
- $\Delta V = \pm 5V$.
- Full Power Bandwidth guaranteed based on slew rate measurement using: $FPBW = \text{Slew Rate} / 2\pi V_{PEAK}$.
- $V_{OUT} = \pm 5V$.

Test Circuits and Waveforms

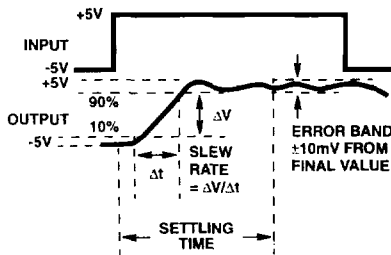

NOTE: Measured on both positive and negative transitions from 0V to +200mV and 0V to -200mV at the output.

FIGURE 1. SLEW RATE AND SETTLING TIME

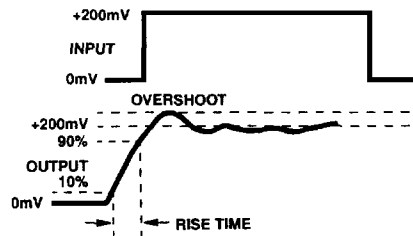

NOTE: Measured on both positive and negative transitions from 0V to +200mV and 0V to -200mV at the output.

FIGURE 2. TRANSIENT RESPONSE

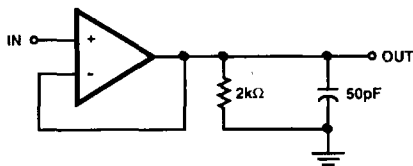

NOTE: Measured on both positive and negative transitions from 0V to +200mV and 0V to -200mV at the output.

FIGURE 3. SLEW RATE AND TRANSIENT RESPONSE

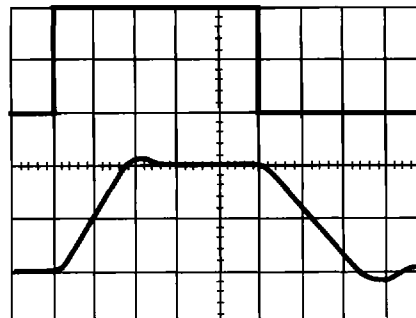

$R_L = 2k\Omega$, $C_L = 50pF$ Vertical = 5V/Div.
Upper Trace: Input Horizontal = 200ns/Div.
Lower Trace: Output $T_A = 25^\circ C$, $V_S = \pm 15V$

FIGURE 4. VOLTAGE FOLLOWER PULSE RESPONSE

Test Circuits and Waveforms (Continued)

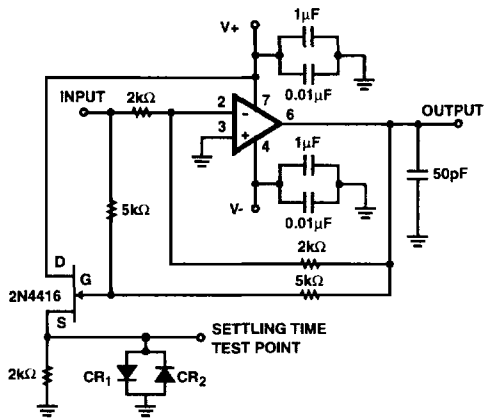

NOTES:

13. $A_V = -1$.
14. Feedback and summing resistor ratios should be 0.1% matched.
15. Clipping diodes CR₁ and CR₂ are optional. HP5082-2810 recommended.

FIGURE 5. SETTLING TIME TEST CIRCUIT

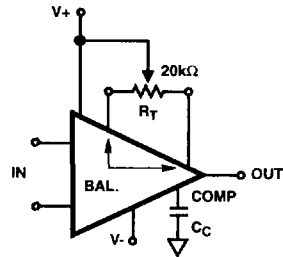

NOTE: Tested offset adjustment range is $IVOS + 1mV$ minimum referred to output. Typical ranges are $\pm 6mV$ with $R_T = 20k\Omega$.

FIGURE 6. SUGGESTED V_{OS} ADJUSTMENT AND COMPENSATION HOOK UP

Schematic

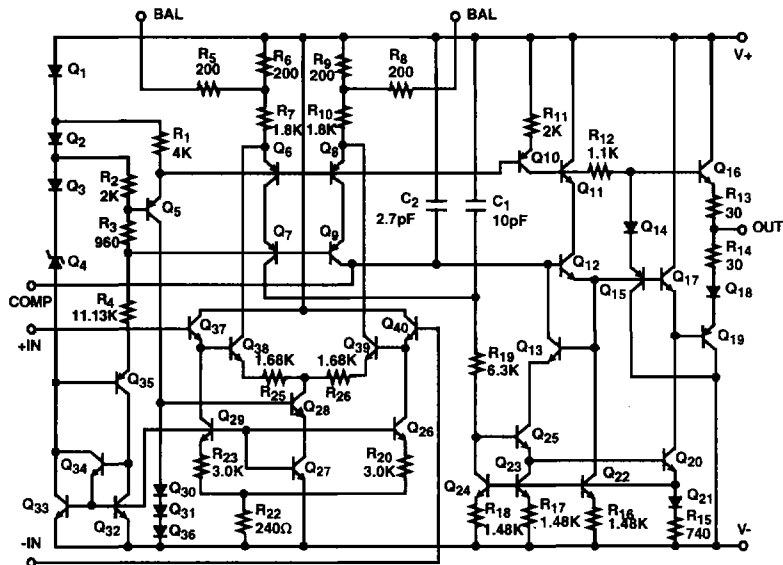

Typical Performance Curves

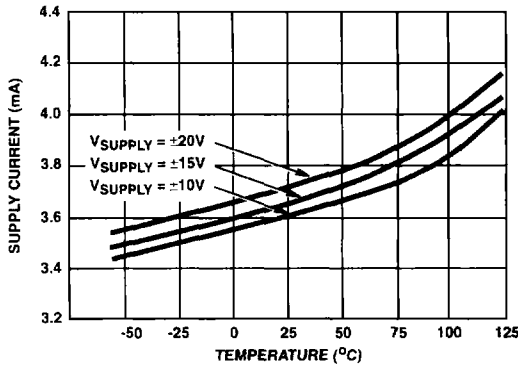

FIGURE 7. POWER SUPPLY CURRENT vs TEMPERATURE

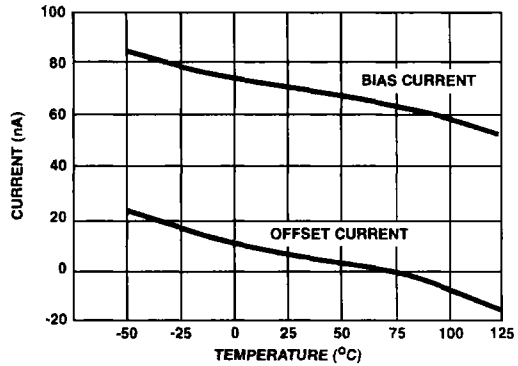

FIGURE 8. INPUT BIAS AND OFFSET CURRENT vs TEMPERATURE

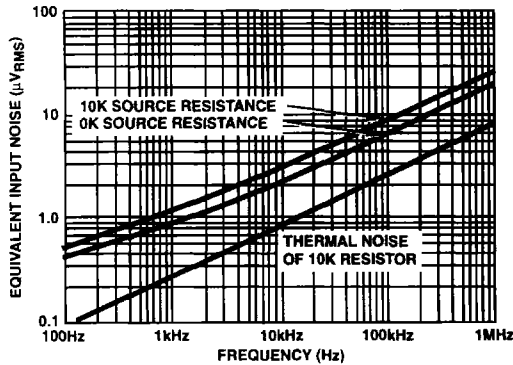

FIGURE 9. EQUIVALENT INPUT NOISE vs BANDWIDTH (WITH 10Hz HIGH PASS FILTER)

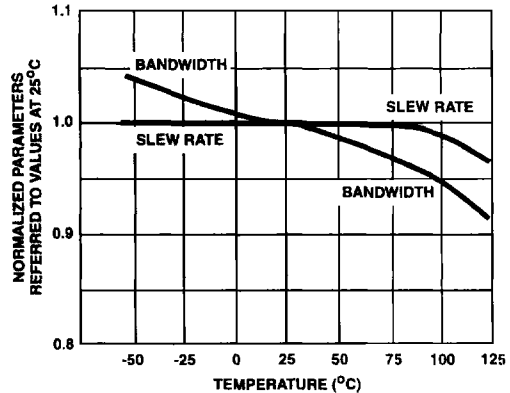

FIGURE 10. NORMALIZED AC PARAMETERS vs TEMPERATURE

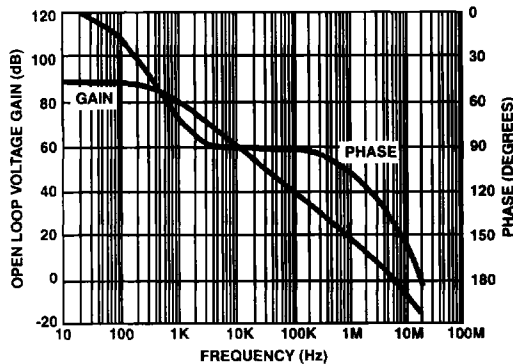

FIGURE 11. OPEN LOOP GAIN AND PHASE RESPONSE

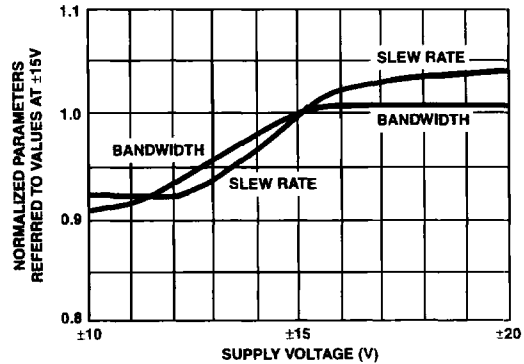

FIGURE 12. NORMALIZED AC PARAMETERS vs SUPPLY VOLTAGE AT 25°C

Typical Performance Curves (Continued)

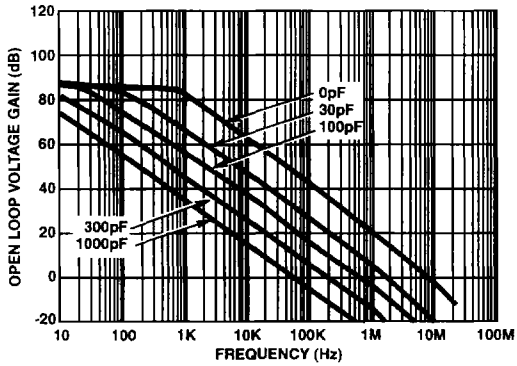

FIGURE 13. OPEN LOOP GAIN RESPONSE FOR VARIOUS VALUES OF CAPACITORS FROM COMPENSATION PIN TO GROUND

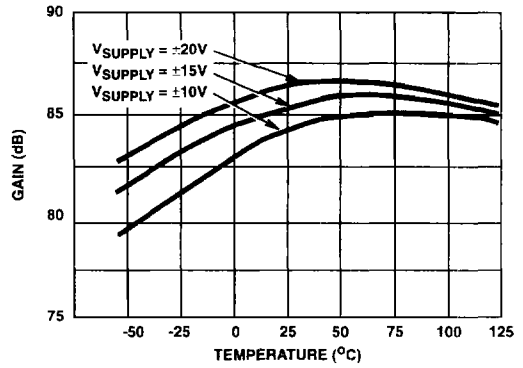

FIGURE 14. OPEN LOOP VOLTAGE GAIN vs TEMPERATURE

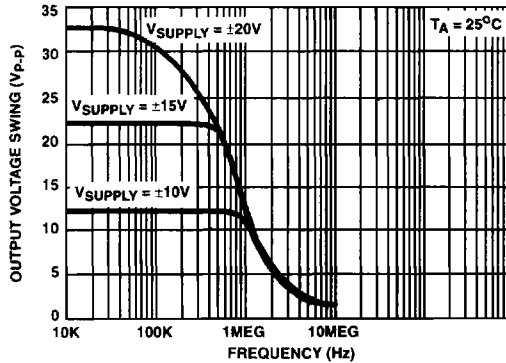

FIGURE 15. OUTPUT VOLTAGE SWING vs FREQUENCY

HA-2510, HA-2512, HA-2515

Die Characteristics

DIE DIMENSIONS:

65 mils x 57 mils x 19 mils
1650 μ m x 1450 μ m x 483 μ m

METALLIZATION:

Type: Al, 1% Cu
Thickness: 16k Å \pm 2k Å

PASSIVATION:

Type: Nitride (Si_3N_4) over Silox (SiO_2 , 5% Phos.)
Silox Thickness: 12k Å \pm 2k Å
Nitride Thickness: 3.5k Å \pm 1.5k Å

SUBSTRATE POTENTIAL (Powered Up):

Unbiased

TRANSISTOR COUNT:

40

PROCESS:

Bipolar Dielectric Isolation

Metallization Mask Layout

HA-2510, HA-2512, HA-2515

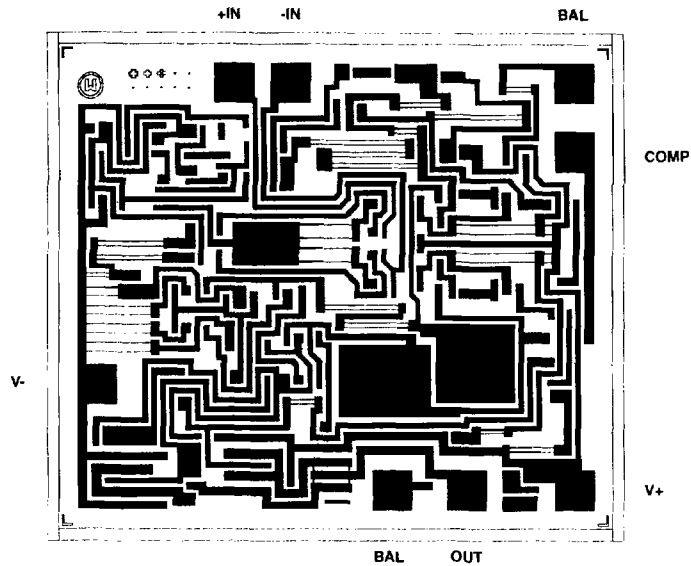

3

OPERATIONAL
AMPLIFIERS