



### Typical Applications

The HMC453ST89 / HMC453ST89E is ideal for applications requiring a high dynamic range amplifier:

- GSM, GPRS & EDGE
- CDMA & W-CDMA
- CATV/Cable Modem
- Fixed Wireless

### Features

- Output IP3: +49 dBm
- 20.5 dB Gain @ 400 MHz
- 7.5 dB Gain @ 2100 MHz
- 41% PAE @ +32.5 dBm Pout
- +26 dBm CDMA2000 Channel Power @ -45 dBc ACP
- Included in the HMC-DK002 Designer's Kit

### Functional Diagram

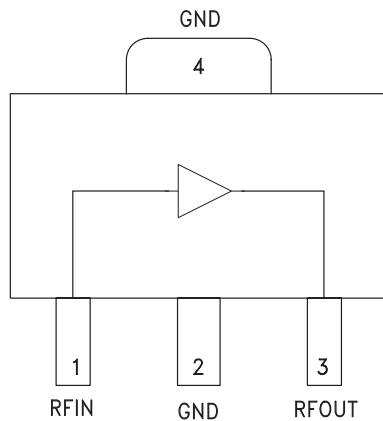

### General Description

The HMC453ST89 & HMC453ST89E are high dynamic range GaAs InGaP HBT 1.6 Watt MMIC power amplifiers operating from 0.4 to 2.2 GHz and packaged in industry standard SOT89 packages. Utilizing a minimum number of external components and a single +5V supply, the amplifier output IP3 can be optimized to +47 dBm at 0.4 GHz or +49 dBm at 2.1 GHz. The high output IP3 and PAE make the HMC453ST89 & HMC453ST89E ideal power amplifiers for Cellular/PCS/3G and Fixed Wireless applications.

### Electrical Specifications, $T_A = +25^\circ\text{C}$ , $V_s = +5\text{V}$ [1]

Parameter	Min.	Typ.	Max.	Min.	Typ.	Max.	Min.	Typ.	Max.	Min.	Typ.	Max.	Min.	Typ.	Max.	Units
Frequency Range	400 - 410			450 - 496			810 - 960			1710 - 1990			2010 - 2170			MHz
Gain	18	20.5		16.5	19		12	14.5		6	8.5		6	7.5		dB
Gain Variation Over Temperature		0.012	0.02		0.012	0.02		0.012	0.02		0.012	0.02		0.012	0.02	dB / °C
Input Return Loss		20			14			20			15			13		dB
Output Return Loss		12			12			13			15			18		dB
Output Power for 1dB Compression (P1dB)	28.5	31.5		29	32		28.5	31.5		29	32		29.5	32.5		dBm
Saturated Output Power (Psat)		32			32.25			31.75			32.5			32.75		dBm
Output Third Order Intercept (IP3) [2]	44	47		45	48		44	47		46	49		46	49		dBm
Noise Figure		9			9			6.5			7			6.5		dB
Supply Current (Icq)		725			725			725			725			725		mA

[1] Specifications and data reflect HMC453ST89 measured using the respective application circuits for each designated frequency band found herein. Contact the HMC Applications Group for assistance in optimizing performance for your application.

[2] Two-tone input power of 0 dBm per tone, 1 MHz spacing.



# HMC453ST89 / 453ST89E

## InGaP HBT 1.6 WATT POWER AMPLIFIER, 0.4 - 2.2 GHz

### Broadband Gain & Return Loss @ 400

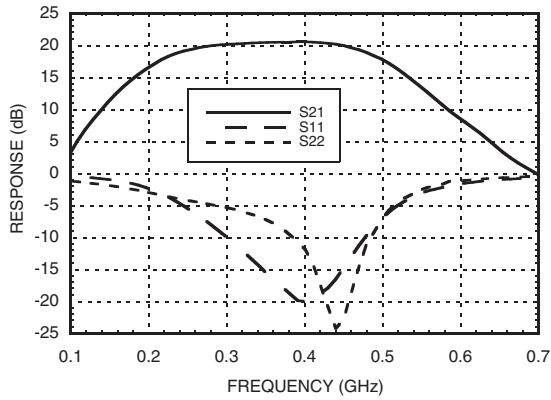

### Gain vs. Temperature @ 400 MHz

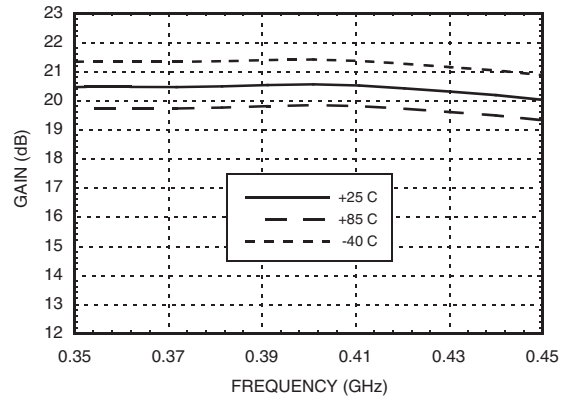

### Input Return Loss vs. Temperature @ 400 MHz

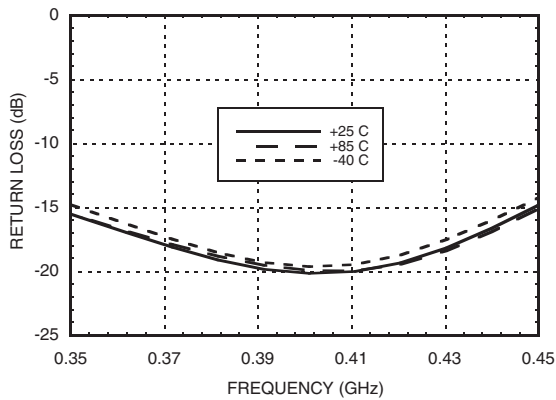

### Output Return Loss vs. Temperature @ 400 MHz

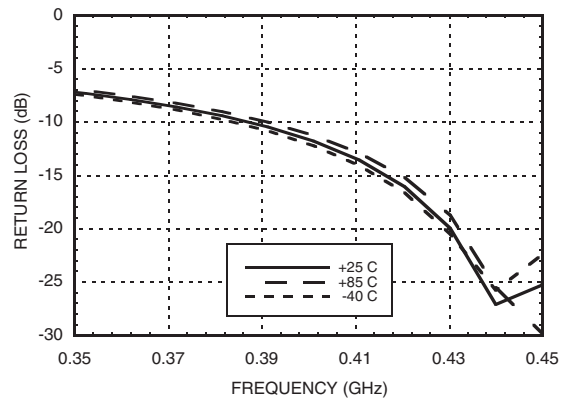

### P1dB vs. Temperature @ 400 MHz

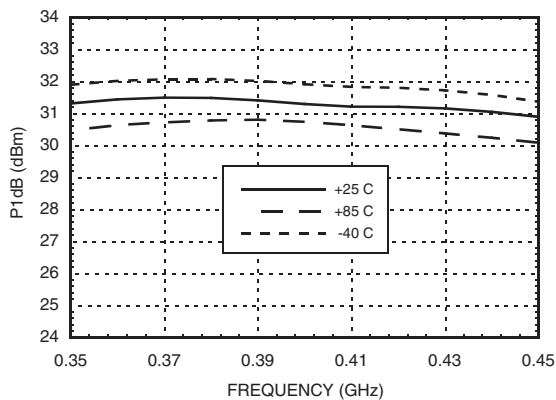

### Psat vs. Temperature @ 400 MHz

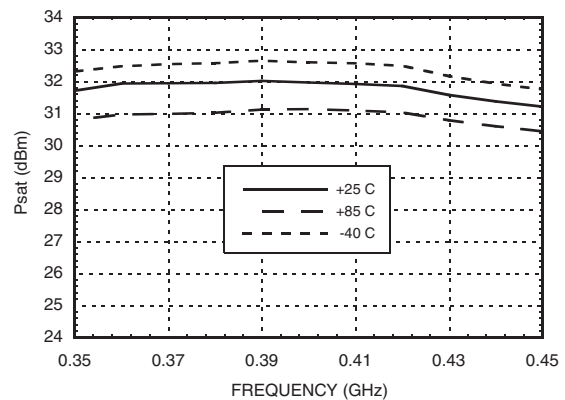



**HMC453ST89 / 453ST89E**

**InGaP HBT 1.6 WATT POWER  
AMPLIFIER, 0.4 - 2.2 GHz**

**Output IP3 vs. Temperature @ 400 MHz**

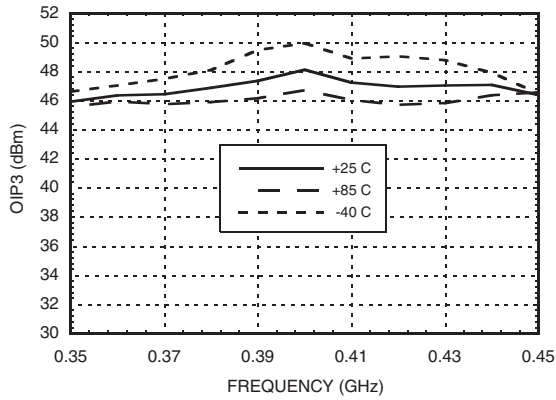

**Noise Figure vs. Temperature @ 400 MHz**

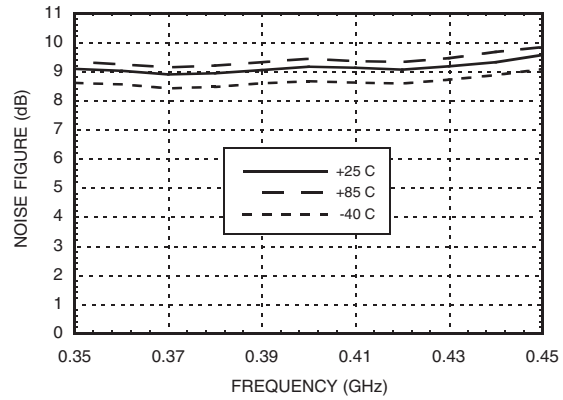

**Reverse Isolation vs. Temperature @ 400 MHz**

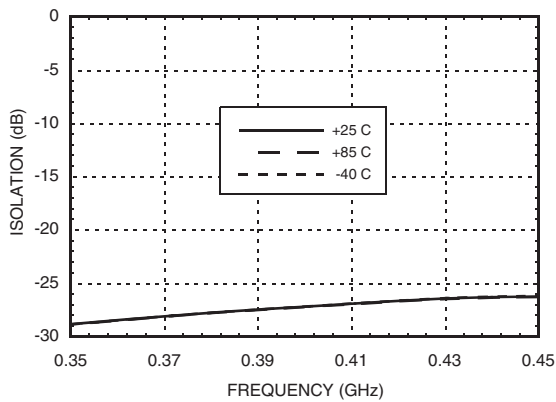

**Gain, Power & IP3 vs. Supply Voltage @ 400 MHz**

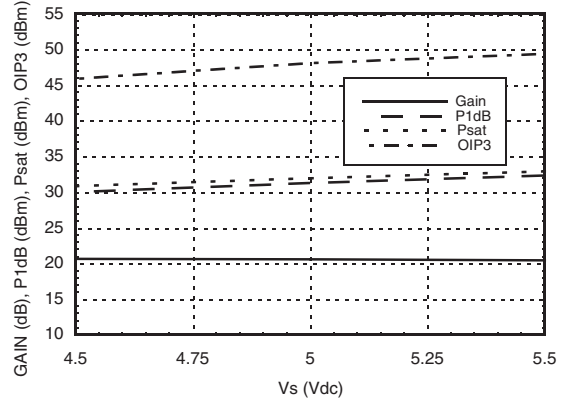

**Power Compression @ 400 MHz**

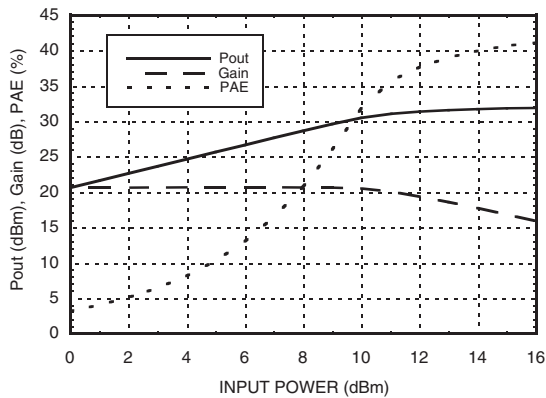

**ACPR vs. Supply Voltage @ 400 MHz  
W-CDMA, 64 DPCH**

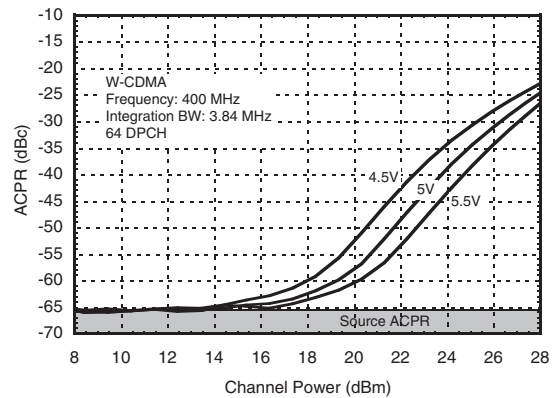



# HMC453ST89 / 453ST89E

## InGaP HBT 1.6 WATT POWER AMPLIFIER, 0.4 - 2.2 GHz

### Broadband Gain & Return Loss @ 470 MHz

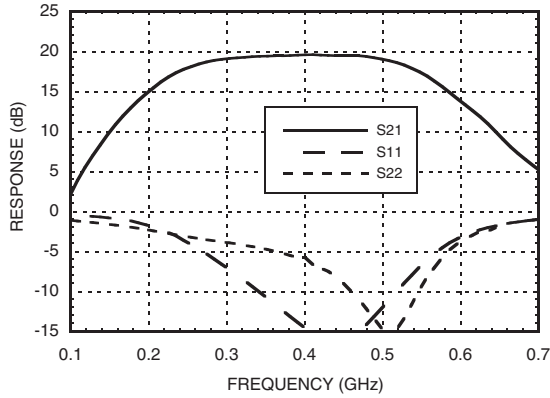

### Gain vs. Temperature @ 470 MHz

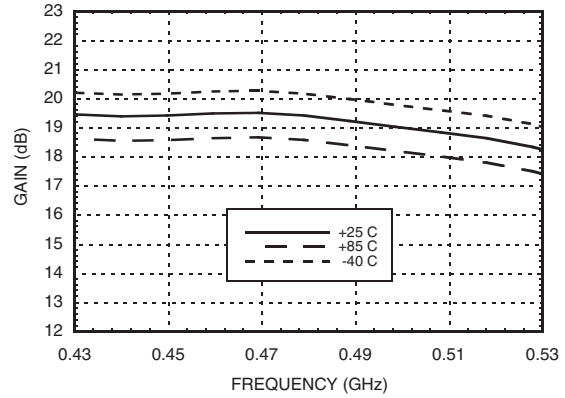

### Input Return Loss vs. Temperature @ 470 MHz

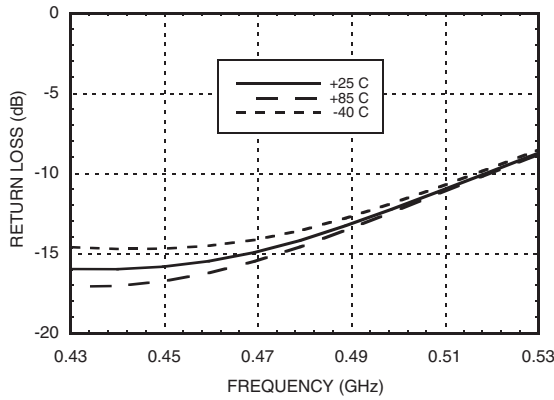

### Output Return Loss vs. Temperature @ 470 MHz

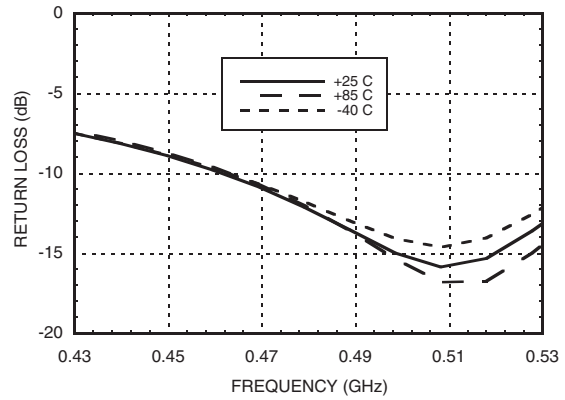

### P1dB vs. Temperature @ 470 MHz

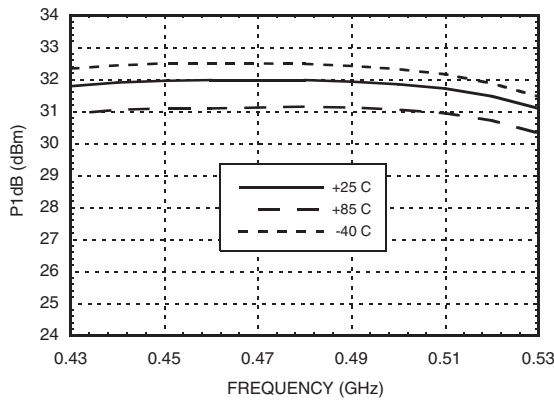

### Psat vs. Temperature @ 470 MHz

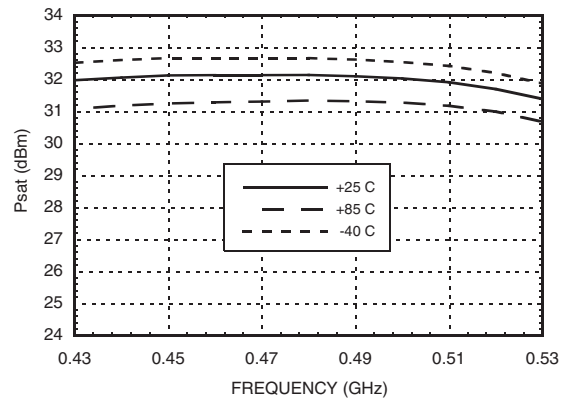



# HMC453ST89 / 453ST89E

## InGaP HBT 1.6 WATT POWER AMPLIFIER, 0.4 - 2.2 GHz

**Output IP3 vs. Temperature @ 470 MHz**

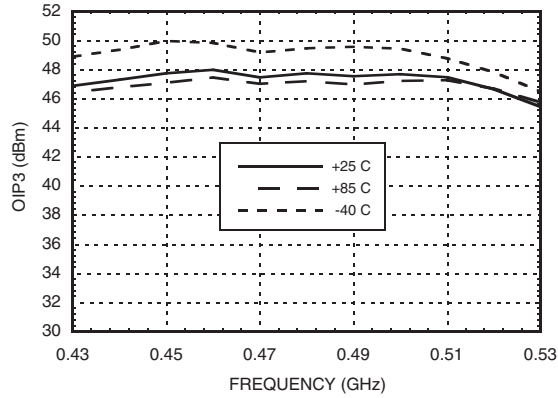

**Noise Figure vs. Temperature @ 470 MHz**

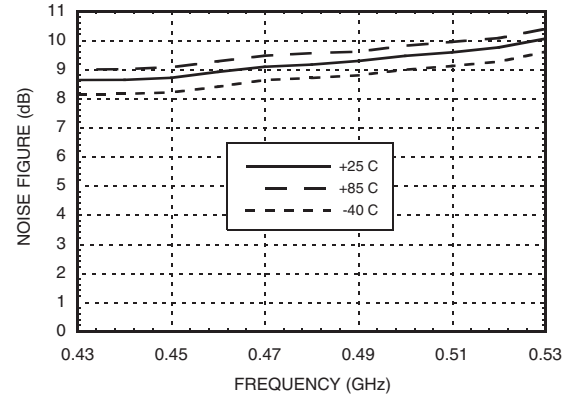

**Reverse Isolation vs. Temperature @ 470 MHz**

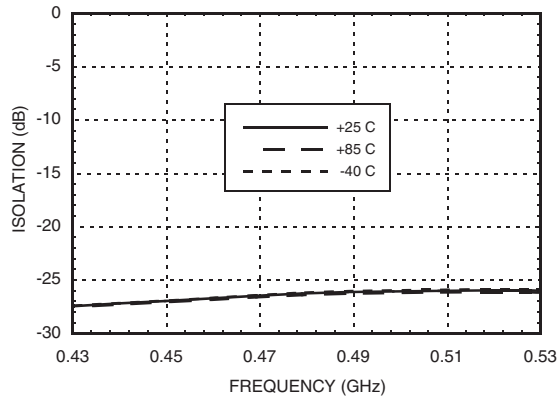

**Gain, Power & IP3 vs. Supply Voltage @ 470 MHz**

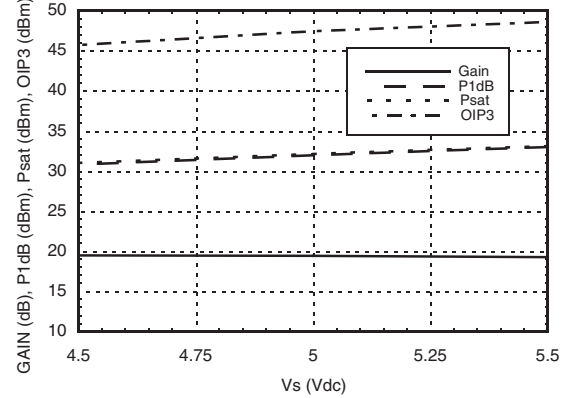

**Power Compression @ 470 MHz**

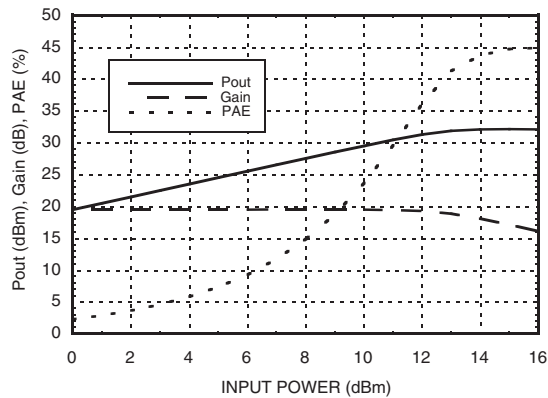

**ACPR vs. Supply Voltage @ 470 MHz W-CDMA, 64 DPCH**

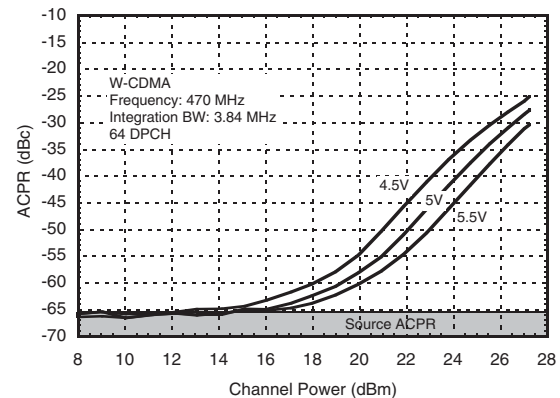



# HMC453ST89 / 453ST89E

## InGaP HBT 1.6 WATT POWER AMPLIFIER, 0.4 - 2.2 GHz

### Broadband Gain & Return Loss @ 900 MHz

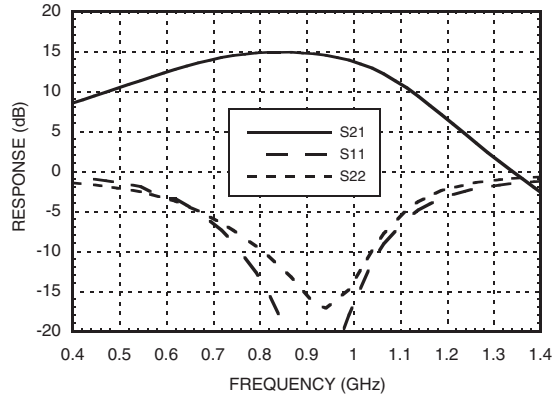

### Gain vs. Temperature @ 900 MHz

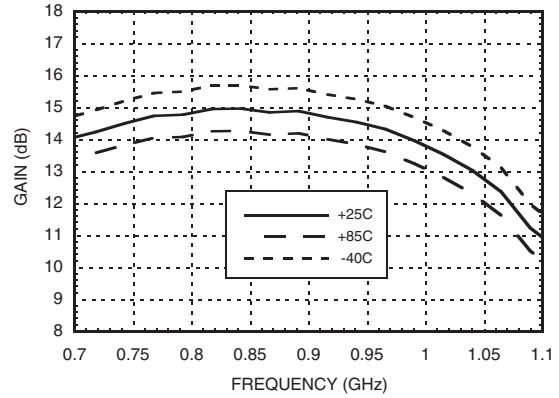

### Input Return Loss vs. Temperature @ 900 MHz

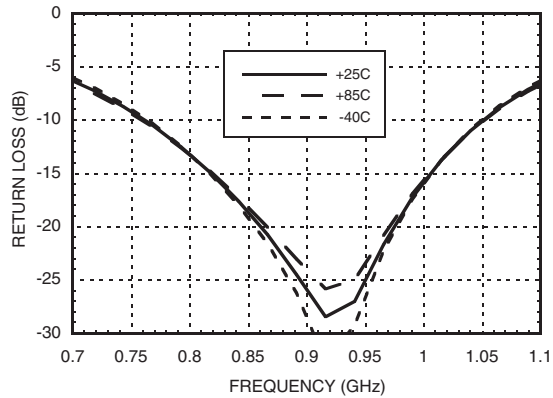

### Output Return Loss vs. Temperature @ 900 MHz

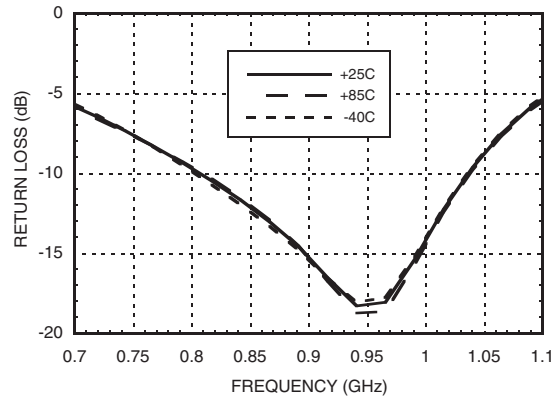

### P1dB vs. Temperature @ 900 MHz

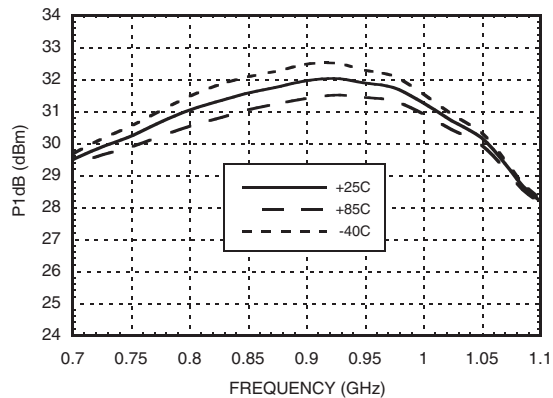

### Psat vs. Temperature @ 900 MHz

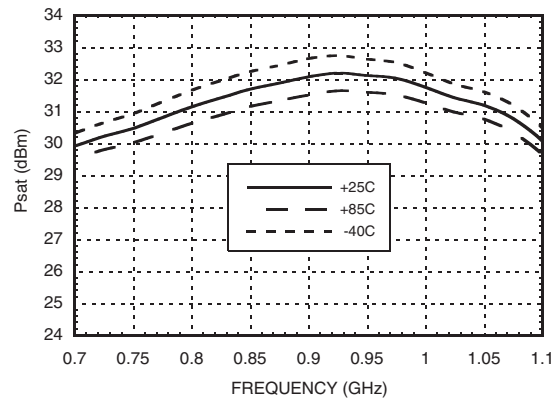



**Output IP3 vs. Temperature @ 900 MHz**

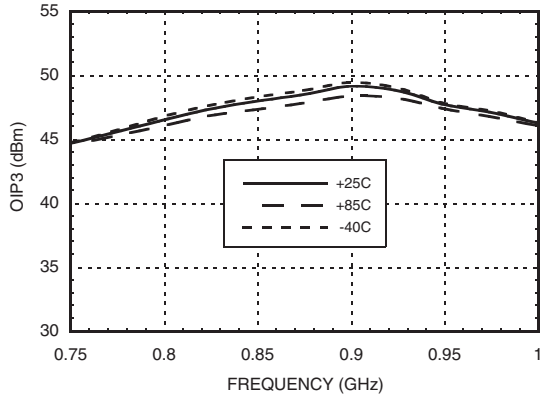

**Noise Figure vs. Temperature @ 900 MHz**

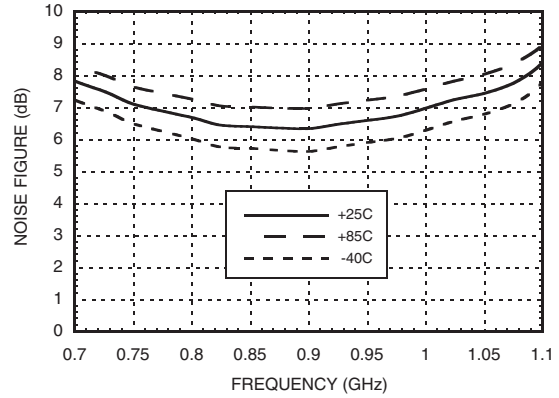

**Reverse Isolation vs. Temperature @ 900 MHz**

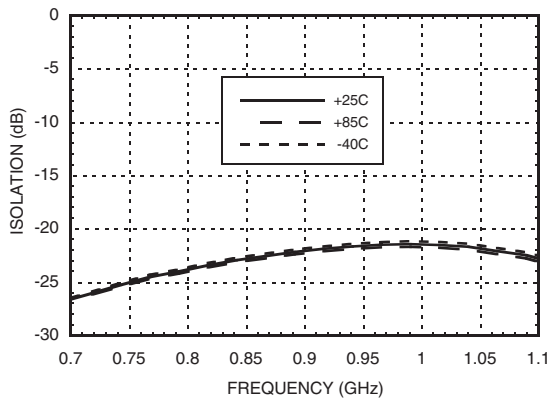

**Gain, Power & IP3 vs. Supply Voltage @ 900 MHz**

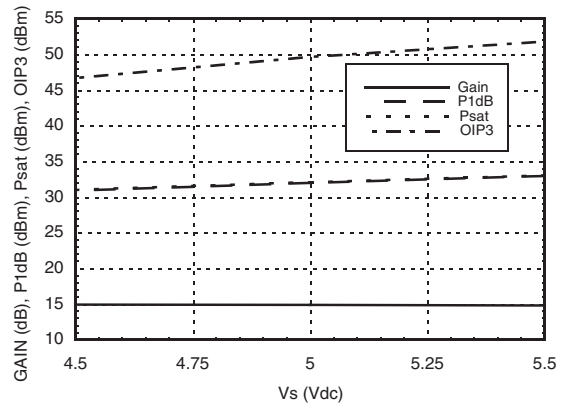

**Power Compression @ 900 MHz**

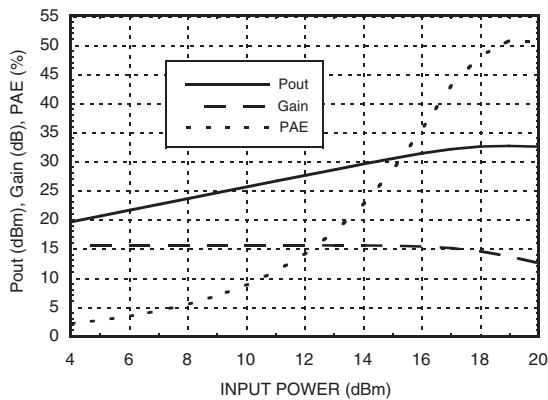

**ACPR vs. Supply Voltage @ 910 MHz CDMA IS95, 9 Channels Forward**

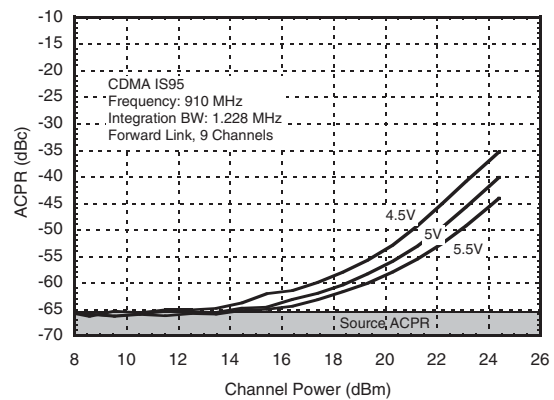



### Broadband Gain & Return Loss @ 1900 MHz

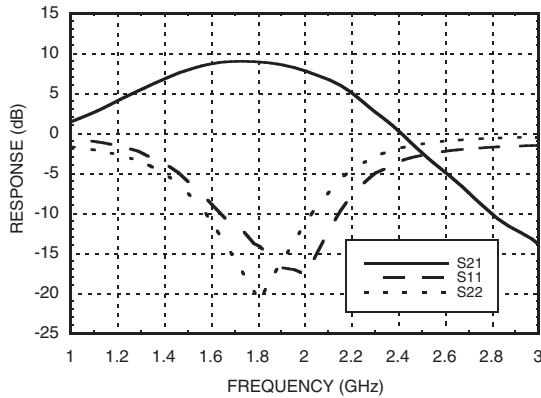

### Gain vs. Temperature @ 1900 MHz

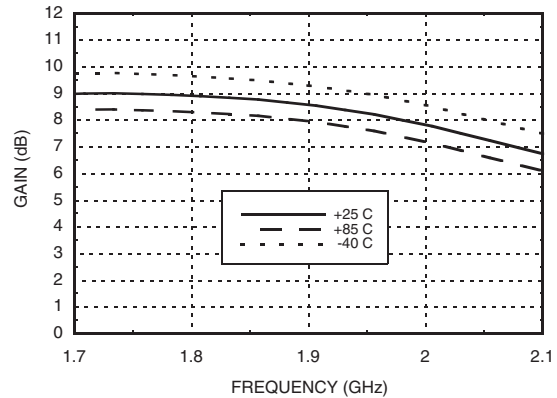

### Input Return Loss vs. Temperature @ 1900 MHz

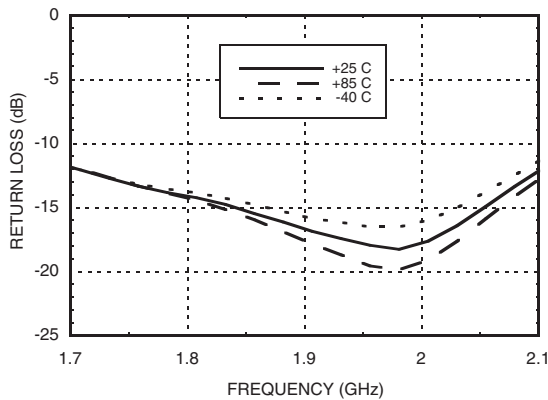

### Output Return Loss vs. Temperature @ 1900 MHz

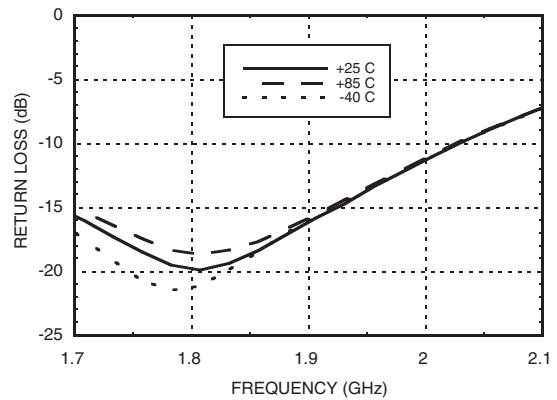

### P1dB vs. Temperature @ 1900 MHz

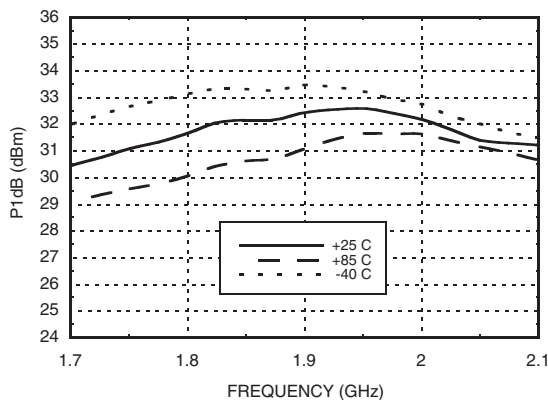

### Psat vs. Temperature @ 1900 MHz

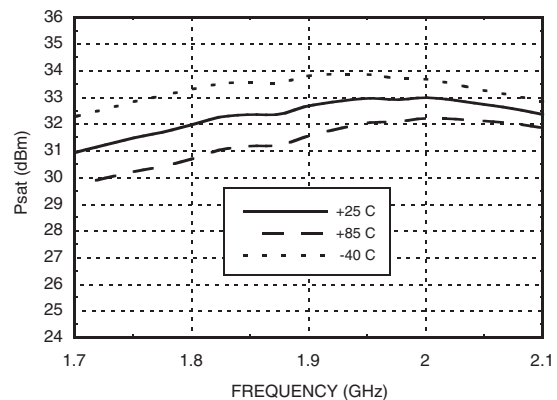





# HMC453ST89 / 453ST89E

## InGaP HBT 1.6 WATT POWER AMPLIFIER, 0.4 - 2.2 GHz

9

AMPLIFIERS - LINEAR & POWER - SMT

**Output IP3 vs. Temperature @ 1900 MHz**

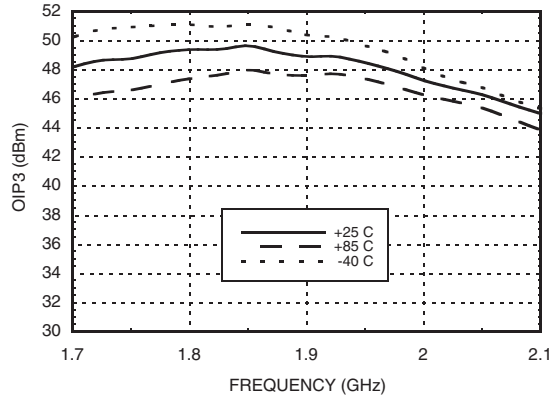

**Noise Figure vs. Temperature @ 1900 MHz**

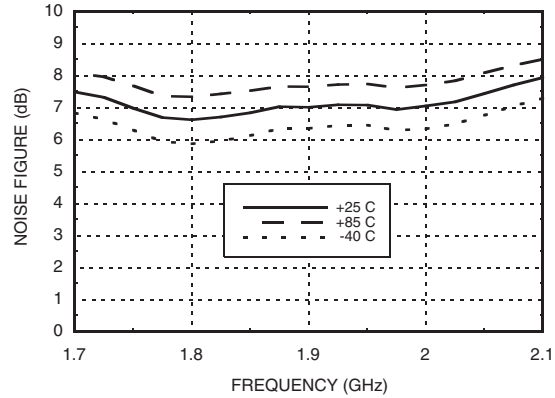

**Reverse Isolation vs. Temperature @ 1900 MHz**

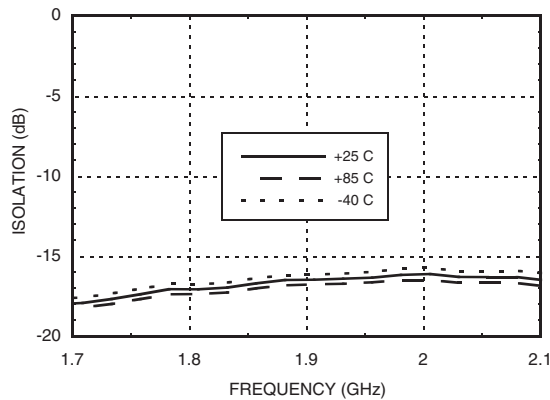

**Gain, Power & IP3 vs. Supply Voltage @ 1900 MHz**

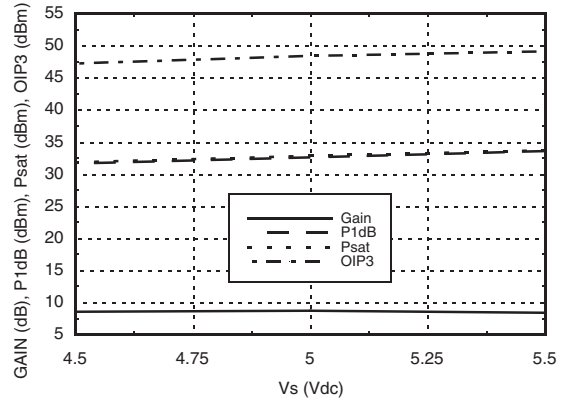

**Power Compression @ 1900 MHz**

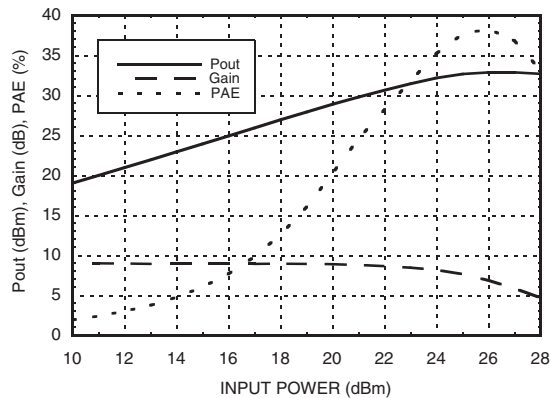

**ACPR vs. Supply Voltage @ 1960 MHz CDMA 2000, 9 Channels Forward**

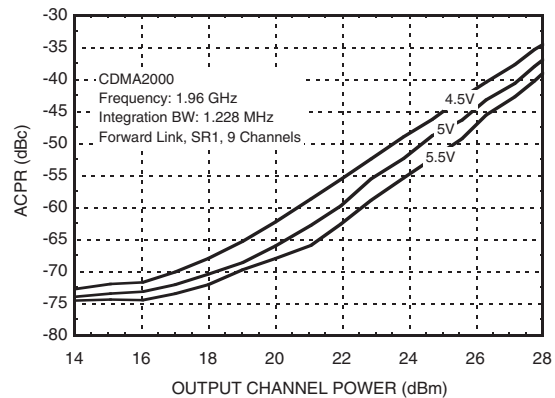



### Broadband Gain & Return Loss @ 2100 MHz

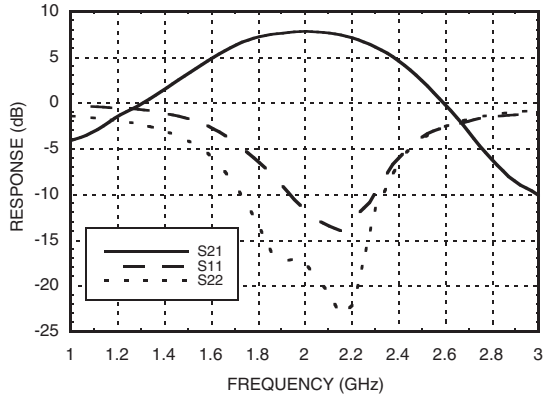

### Gain vs. Temperature @ 2100 MHz

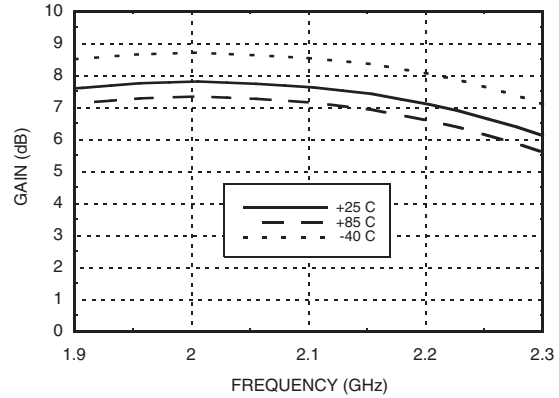

### Input Return Loss vs. Temperature @ 2100 MHz

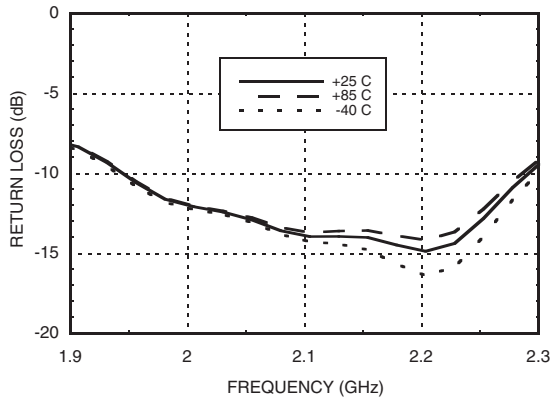

### Output Return Loss vs. Temperature @ 2100 MHz

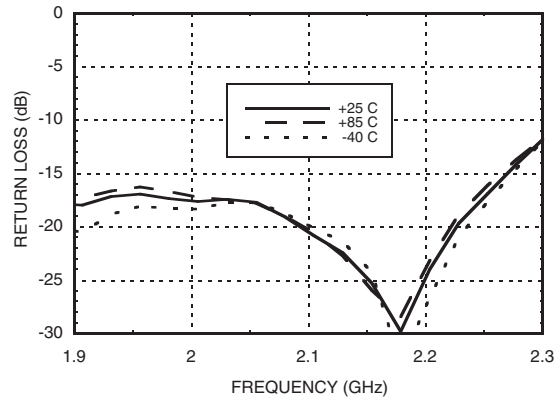

### P1dB vs. Temperature @ 2100 MHz

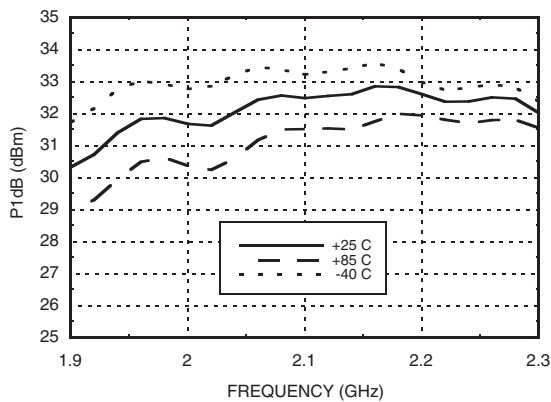

### Psat vs. Temperature @ 2100 MHz

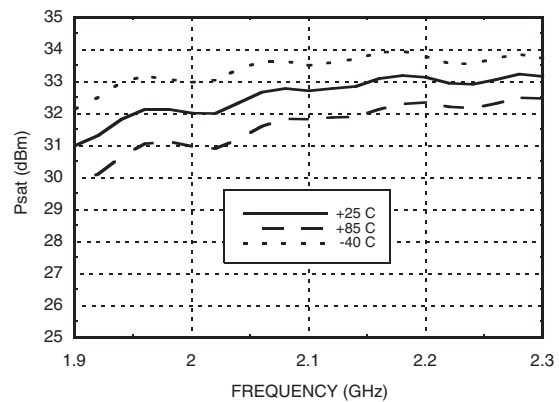

**Output IP3 vs. Temperature @ 2100 MHz**

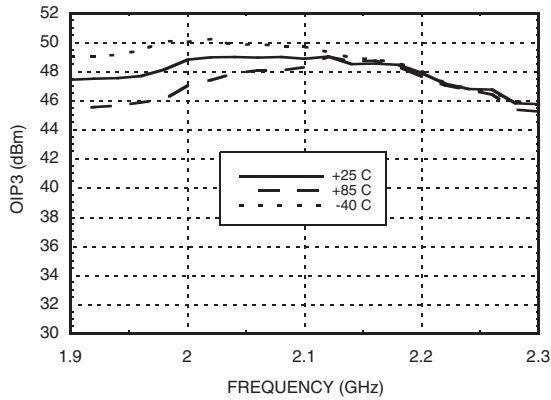

**Noise Figure vs. Temperature @ 2100 MHz**

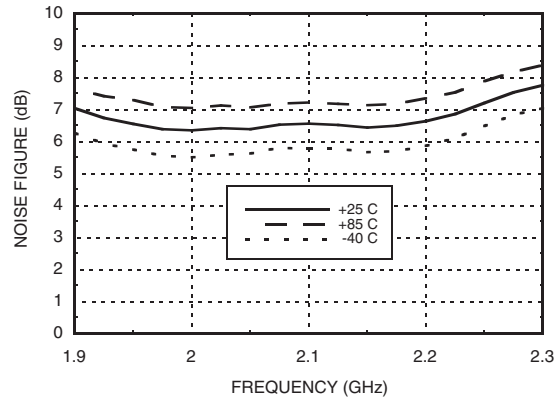

**Reverse Isolation vs. Temperature @ 2100 MHz**

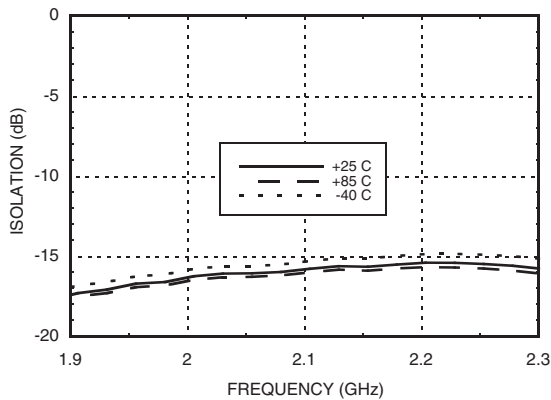

**Gain, Power & IP3 vs. Supply Voltage @ 2100 MHz**

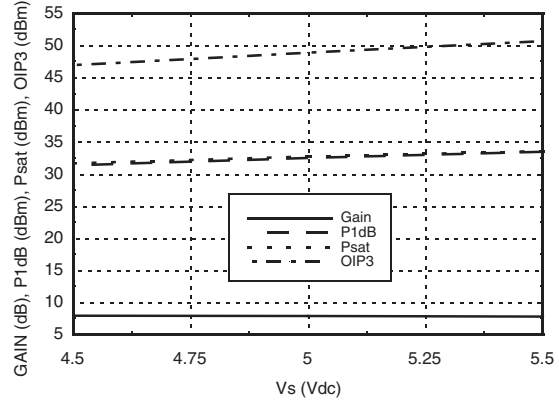

**Power Compressions @ 2100 MHz**

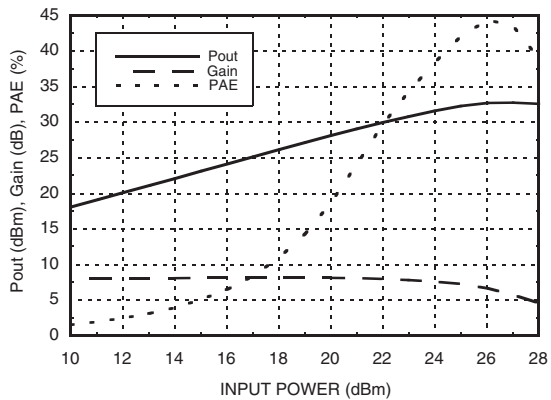

**ACPR vs. Supply Voltage @ 2140 MHz W-CDMA, 64 DPCH**

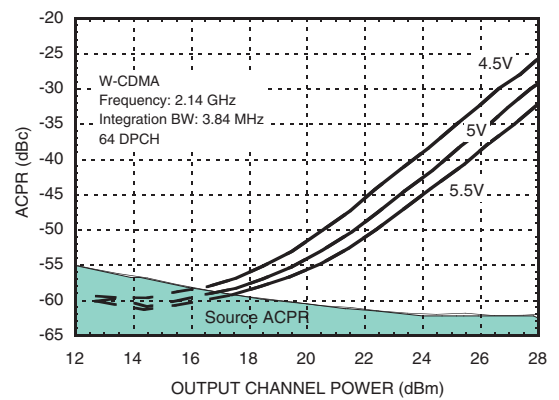

# HMC453ST89 / 453ST89E

## InGaP HBT 1.6 WATT POWER AMPLIFIER, 0.4 - 2.2 GHz

### Power Dissipation

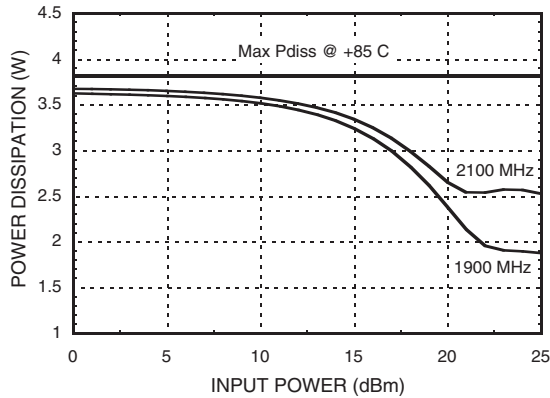

### Absolute Maximum Ratings

Collector Bias Voltage (Vcc)	+6.0 Vdc
RF Input Power (RFIN)(Vs +5Vdc)	+32 dBm
Junction Temperature	150 °C
Continuous Pdiss (T = 85 °C) (derate 58.5 mW/°C above 85 °C)	3.8 W
Thermal Resistance (junction to ground paddle)	17.1 °C/W
Storage Temperature	-65 to +150 °C
Operating Temperature	-40 to +85 °C



ELECTROSTATIC SENSITIVE DEVICE  
OBSERVE HANDLING PRECAUTIONS

### Outline Drawing

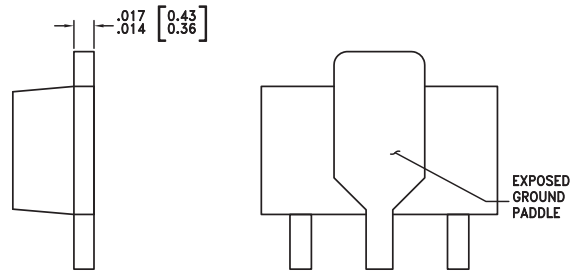
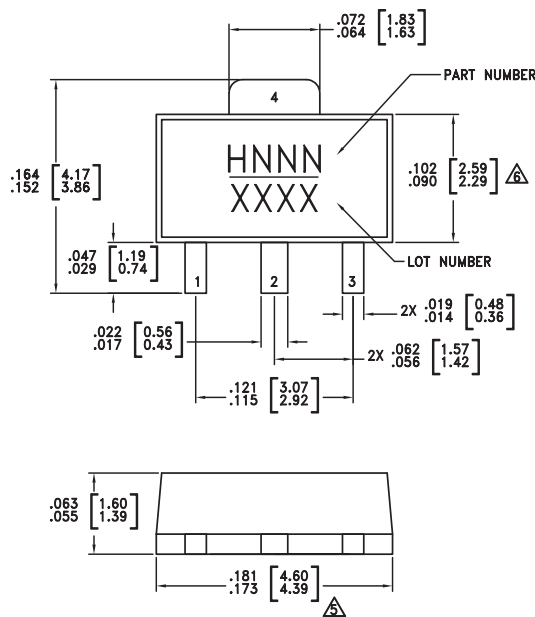

#### NOTES:

- PACKAGE BODY MATERIAL:  
MOLDING COMPOUND MP-180S OR EQUIVALENT.
- LEAD MATERIAL: Cu w/ Ag SPOT PLATING.
- LEAD PLATING: 100% MATTE TIN.
- DIMENSIONS ARE IN INCHES [MILLIMETERS]
- $\triangle$  DIMENSION DOES NOT INCLUDE MOLDFLASH OF 0.15mm PER SIDE.
- $\triangle$  DIMENSION DOES NOT INCLUDE MOLDFLASH OF 0.25mm PER SIDE.
- ALL GROUND LEADS MUST BE SOLDERED TO PCB RF GROUND.

### Package Information

Part Number	Package Body Material	Lead Finish	MSL Rating	Package Marking <sup>[3]</sup>
HMC453ST89	Low Stress Injection Molded Plastic	Sn/Pb Solder	MSL1 <sup>[1]</sup>	H453 XXXX
HMC453ST89E	RoHS-compliant Low Stress Injection Molded Plastic	100% matte Sn	MSL1 <sup>[2]</sup>	H453 XXXX

[1] Max peak reflow temperature of 235 °C

[2] Max peak reflow temperature of 260 °C

[3] 4-Digit lot number XXXX

### Pin Descriptions

Pin Number	Function	Description	Interface Schematic
1	RFIN	This pin is DC coupled. Off chip matching components are required. See Application Circuit herein.	
3	RFOUT	RF output and DC Bias input for the amplifier. Off chip matching components are required. See Application Circuit herein.	
2, 4	GND	These pins & package bottom must be connected to RF/DC ground.	

### 400 MHz Application Circuit

This circuit was used to specify the performance for 400-410 MHz operation. Contact the HMC Applications Group for assistance in optimizing performance for your application.

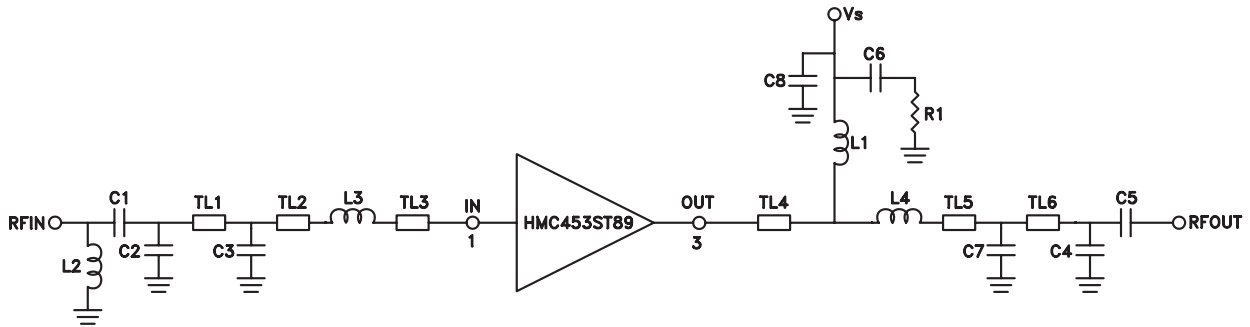

	TL1	TL2	TL3	TL4	TL5	TL6
Impedance	50 Ohm	50 Ohm	50 Ohm	50 Ohm	50 Ohm	50 Ohm
Physical Length	0.16"	0.04"	0.06"	0.21"	0.04"	0.10"
Electrical Length	4°	1°	1°	5°	1°	2°
PCB Material: 10 mil Rogers 4350, Er = 3.48						

Recommended Component Values	
C1, C4	10 pF
C2, C3	8.2 pF
C5	39 pF
C6	100 pF
C7	12 pF
C8	2.2 μF
L1	47 nH
L2	40 nH
L3	4.3 nH
L4	5.1 nH
R1	5.1 Ohm

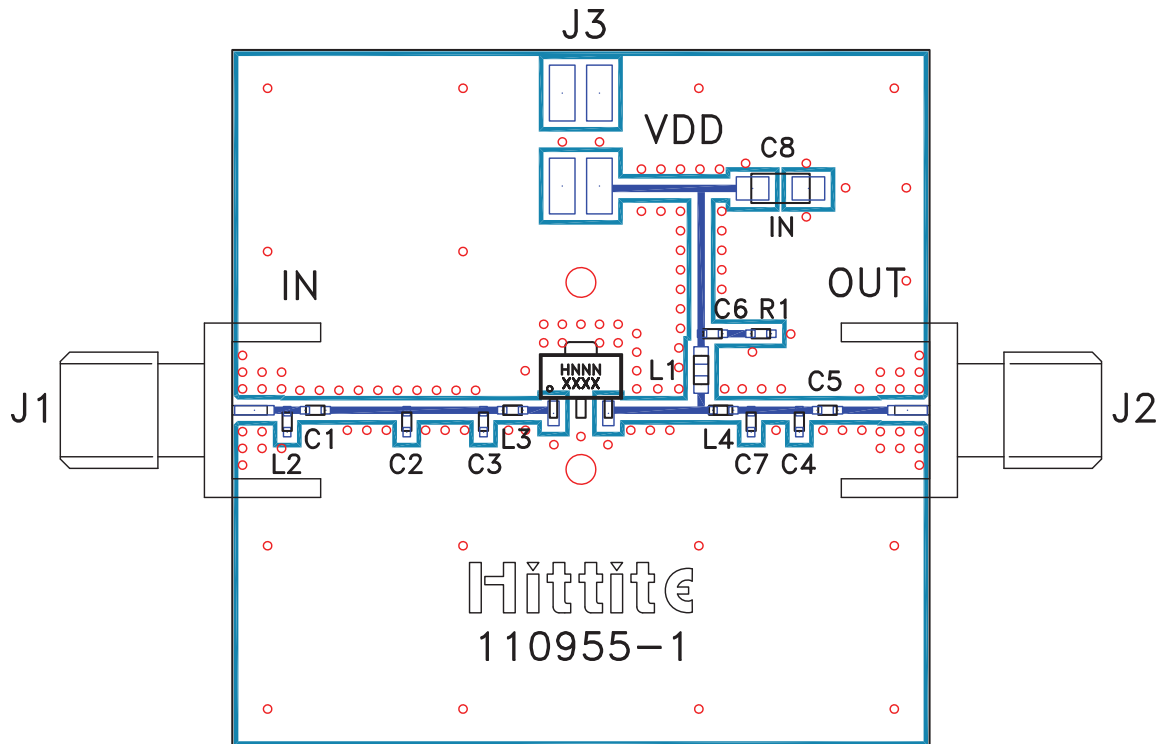
**400 MHz Evaluation PCB**

**List of Materials for Evaluation PCB 110957-400 [1]**

Item	Description
J1 - J2	PCB Mount SMA Connector
J3	2 mm DC Header
C1, C4	10 pF Capacitor, 0402 Pkg.
C2, C3	8.2 pF Capacitor, 0402 Pkg.
C5	39 pF Capacitor, 0402 Pkg.
C6	100 pF Capacitor, 0402 Pkg.
C7	12 pF Capacitor, 0402 Pkg.
C8	2.2 $\mu$ F Capacitor, Tantalum
L1	47 nH Inductor, 0603 Pkg.
L2	40 nH Inductor, 0402 Pkg.
L3	4.3 nH Inductor, 0402 Pkg.
L4	5.1 nH Inductor, 0402 Pkg.
R1	5.1 Ohm Resistor, 0402 Pkg.
U1	HMC453ST89 / HMC453ST89E Linear Amp
PCB [2]	110955 Evaluation PCB, 10 mils

[1] Reference this number when ordering complete evaluation PCB

[2] Circuit Board Material: Rogers 4350, Er = 3.48

The circuit board used in this application should use RF circuit design techniques. Signal lines should have 50 Ohm impedance while the package ground leads and exposed paddle should be connected directly to the ground plane similar to that shown. A sufficient number of via holes should be used to connect the top and bottom ground planes. The evaluation board should be mounted to an appropriate heat sink. The evaluation circuit board shown is available from Hittite upon request.

### 470 MHz Application Circuit

This circuit was used to specify the performance for 450-496 MHz operation. Contact the HMC Applications Group for assistance in optimizing performance for your application.

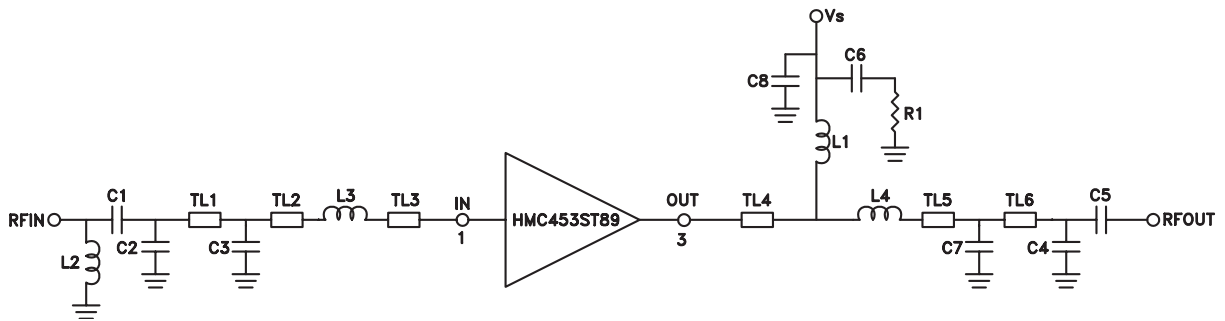

	TL1	TL2	TL3	TL4	TL5	TL6
Impedance	50 Ohm	50 Ohm	50 Ohm	50 Ohm	50 Ohm	50 Ohm
Physical Length	0.16"	0.04"	0.06"	0.21"	0.04"	0.10"
Electrical Length	4°	1°	2°	6°	1°	3°
PCB Material: 10 mil Rogers 4350, Er = 3.48						

Recommended Component Values	
C1	10 pF
C2, C3	6.8 pF
C4	12 pF
C5	39 pF
C6	100 pF
C7	5.6 pF
C8	2.2 μF
L1	47 nH
L2	40 nH
L3	4.7 nH
L4	2.4 nH
R1	5.1 Ohm

### 470 MHz Evaluation PCB

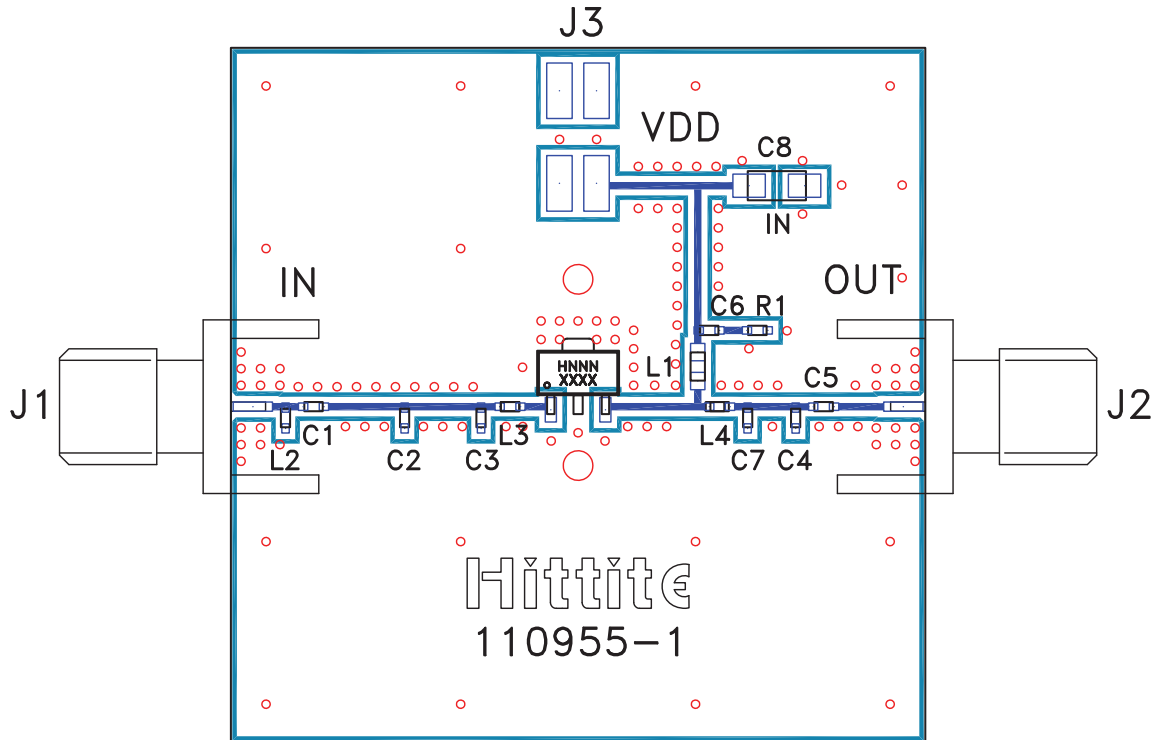

### List of Materials for Evaluation PCB 110961-470 [1]

Item	Description
J1 - J2	PCB Mount SMA Connector
J3	2 mm DC Header
C1	10 pF Capacitor, 0402 Pkg.
C2, C3	6.8 pF Capacitor, 0402 Pkg.
C4	12 pF Capacitor, 0402 Pkg.
C5	39 pF Capacitor, 0402 Pkg.
C6	100 pF Capacitor, 0402 Pkg.
C7	5.6 pF Capacitor, 0402 Pkg.
C8	2.2 $\mu$ F Capacitor, Tantalum
L1	47 nH Inductor, 0603 Pkg.
L2	40 nH Inductor, 0402 Pkg.
L3	4.7 nH Inductor, 0402 Pkg.
L4	2.4 nH Inductor, 0402 Pkg.
R1	5.1 Ohm Resistor, 0402 Pkg.
U1	HMC453ST89 / HMC453ST89E Linear Amp
PCB [2]	110955 Evaluation PCB, 10 mils

[1] Reference this number when ordering complete evaluation PCB

[2] Circuit Board Material: Rogers 4350, Er = 3.48

The circuit board used in this application should use RF circuit design techniques. Signal lines should have 50 Ohm impedance while the package ground leads and exposed paddle should be connected directly to the ground plane similar to that shown. A sufficient number of via holes should be used to connect the top and bottom ground planes. The evaluation board should be mounted to an appropriate heat sink. The evaluation circuit board shown is available from Hittite upon request.



**900 MHz Application Circuit**

This circuit was used to specify the performance for 810-960 MHz operation. Contact the HMC Applications Group for assistance in optimizing performance for your application.

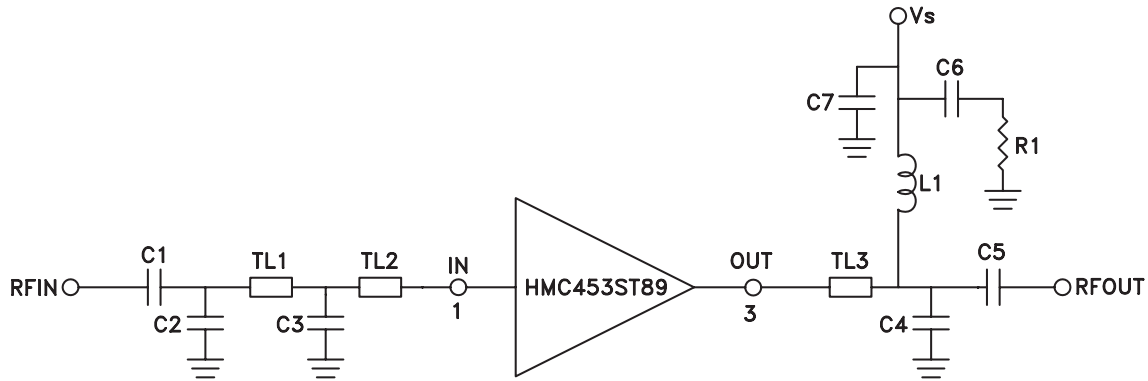

	TL1	TL2	TL3
Impedance	50 Ohm	50 Ohm	50 Ohm
Physical Length	0.25"	0.08"	0.31"
Electrical Length	13°	4°	16°
PCB Material: 10 mil Rogers 4350, Er = 3.48			

Recommended Component Values	
C1	5 pF
C2	3.3 pF
C3	2.7 pF
C4	8.2 pF
C5	12 pF
C6	100 pF
C7	2.2 μF
L1	15 nH
R1	5.1 Ohm

### 900 MHz Evaluation PCB

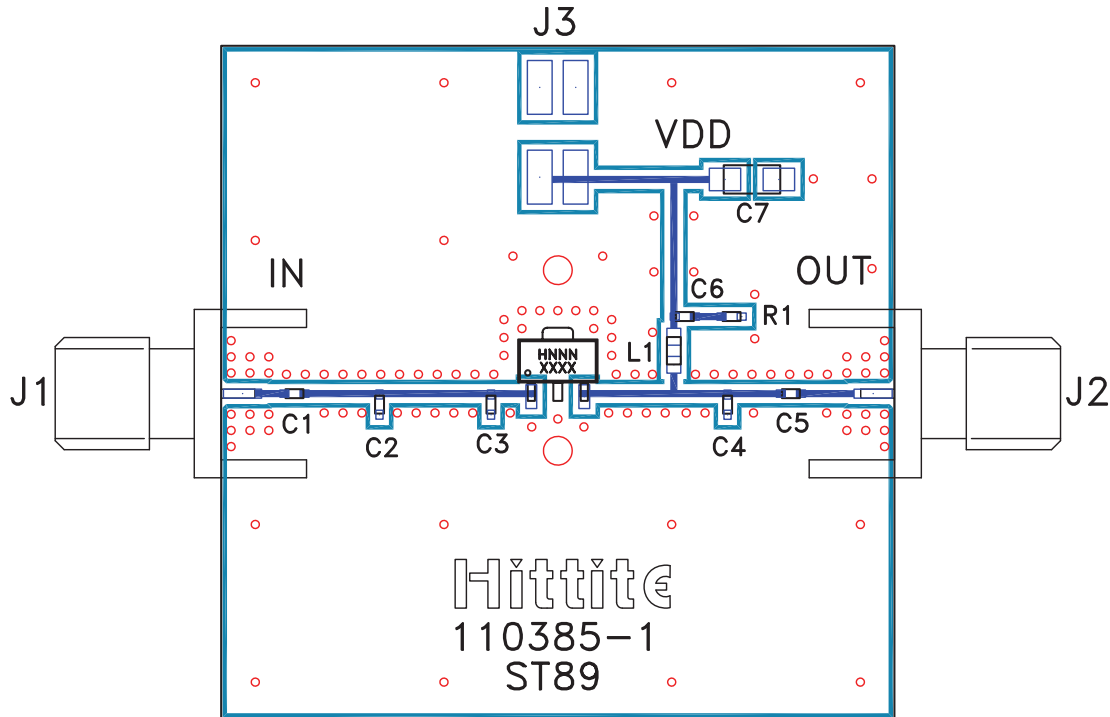

### List of Materials for Evaluation PCB 110387-900 [1]

Item	Description
J1 - J2	PCB Mount SMA Connector
J3	2 mm DC Header
C1	5 pF Capacitor, 0402 Pkg.
C2	3.3 pF Capacitor, 0402 Pkg.
C3	2.7 pF Capacitor, 0402 Pkg.
C4	8.2 pF Capacitor, 0402 Pkg.
C5	12 pF Capacitor, 0402 Pkg.
C6	100 pF Capacitor, 0402 Pkg.
C7	2.2 μF Capacitor, Tantalum
L1	15 nH Inductor, 0603 Pkg.
R1	5.1 Ohm Resistor, 0402 Pkg.
U1	HMC453ST89 / HMC453ST89E Linear Amp
PCB [2]	110385 Evaluation PCB, 10 mils

[1] Reference this number when ordering complete evaluation PCB

[2] Circuit Board Material: Rogers 4350, Er = 3.48

The circuit board used in this application should use RF circuit design techniques. Signal lines should have 50 Ohm impedance while the package ground leads and exposed paddle should be connected directly to the ground plane similar to that shown. A sufficient number of via holes should be used to connect the top and bottom ground planes. The evaluation board should be mounted to an appropriate heat sink. The evaluation circuit board shown is available from Hittite upon request.



### 1900 MHz Application Circuit

This circuit was used to specify the performance for 1710-1990 MHz operation. Contact the HMC Applications Group for assistance in optimizing performance for your application.

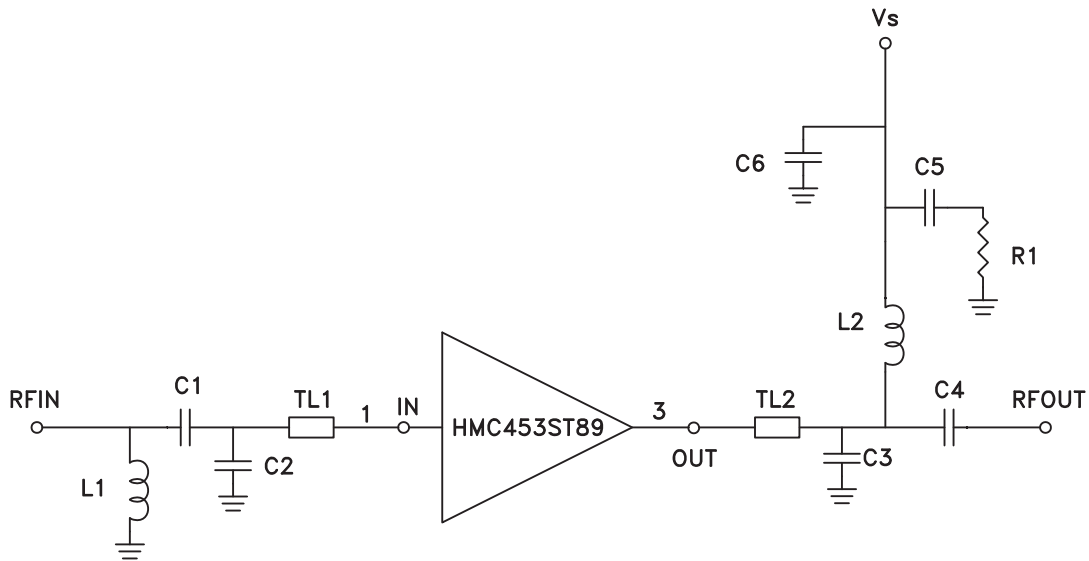

	TL1	TL2
Impedance	50 Ohm	50 Ohm
Physical Length	0.04"	0.07"
Electrical Length	4°	8°
PCB Material: 10 mil Rogers 4350, Er = 3.48		

Recommended Component Values	
C1	1.2 pF
C2	1.5 pF
C3	3.9 pF
C4	15 pF
C5	100 pF
C6	2.2 μF
L1	20 nH
L2	12 nH
R1	5.1 Ohm



**1900 MHz Evaluation PCB**

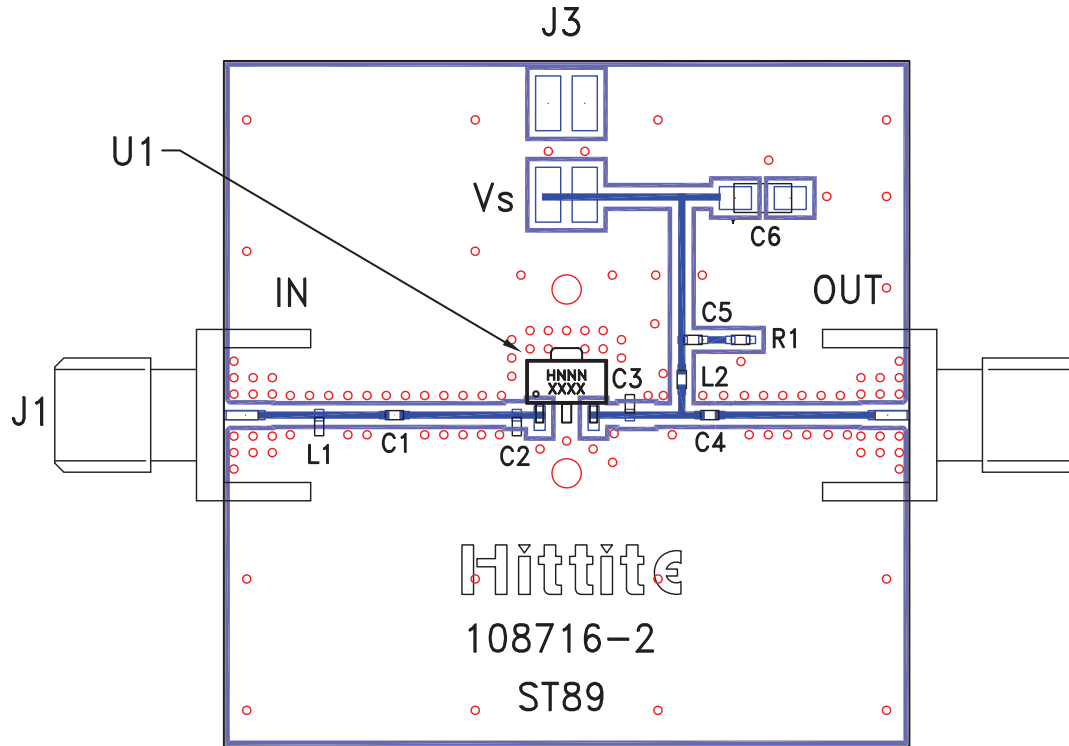

**List of Materials for Evaluation PCB 108718-1900 [1]**

Item	Description
J1 - J2	PCB Mount SMA Connector
J3	2 mm DC Header
C1	1.2 pF Capacitor, 0402 Pkg.
C2	1.5 pF Capacitor, 0402 Pkg.
C3	3.9 pF Capacitor, 0402 Pkg.
C4	15 pF Capacitor, 0402 Pkg.
C5	100 pF Capacitor, 0402 Pkg.
C6	2.2 $\mu$ F Capacitor, Tantalum
L1	20 nH Inductor, 0402 Pkg.
L2	12 nH Inductor, 0402 Pkg.
R1	5.1 Ohm Resistor, 0402 Pkg.
U1	HMC453ST89 / HMC453ST89E Linear Amp
PCB [2]	108716 Evaluation PCB, 10 mils

[1] Reference this number when ordering complete evaluation PCB

[2] Circuit Board Material: Rogers 4350, Er = 3.48

The circuit board used in this application should use RF circuit design techniques. Signal lines should have 50 Ohm impedance while the package ground leads and exposed paddle should be connected directly to the ground plane similar to that shown. A sufficient number of via holes should be used to connect the top and bottom ground planes. The evaluation board should be mounted to an appropriate heat sink. The evaluation circuit board shown is available from Hittite upon request.

### 2100 MHz Application Circuit

This circuit was used to specify the performance for 2010-2170 MHz operation. Contact the HMC Applications Group for assistance in optimizing performance for your application.

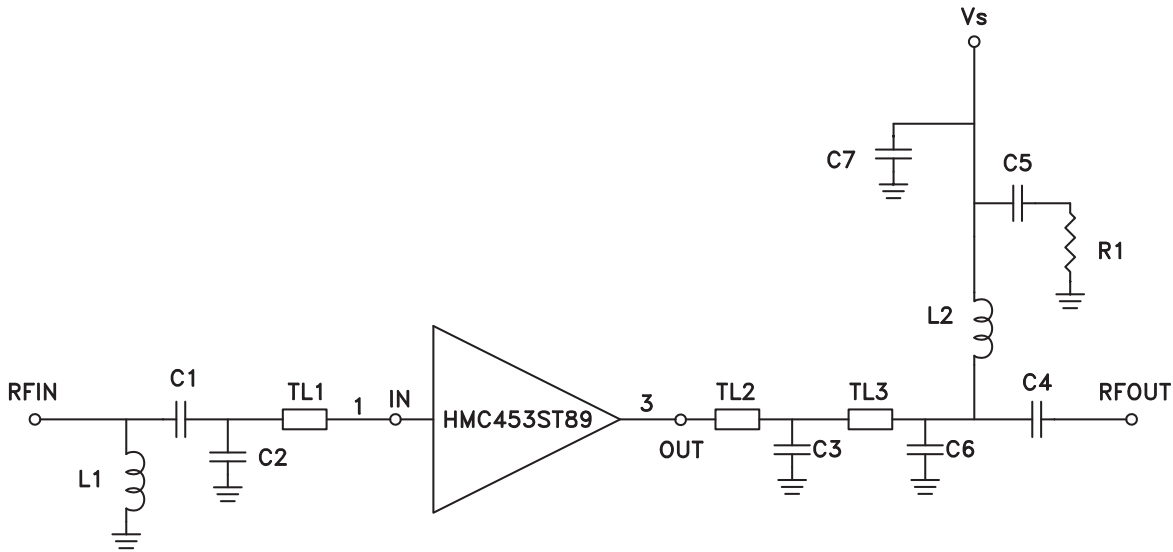

Note: C2 and C3 should be placed as close to pins as possible.

	TL1	TL2	TL3
Impedance	50 Ohm	50 Ohm	50 Ohm
Physical Length	0.04"	0.04"	0.04"
Electrical Length	5°	5°	5°
PCB Material: 10 mil Rogers 4350, Er = 3.48			

Recommended Component Values	
C1	0.8 pF
C2	1 pF
C3	3.3 pF
C4	15 pF
C5	100 pF
C6	0.5 pF
C7	2.2 μF
L1	20 nH
L2	12 nH
R1	5.1 Ohm



**2100 MHz Evaluation PCB**

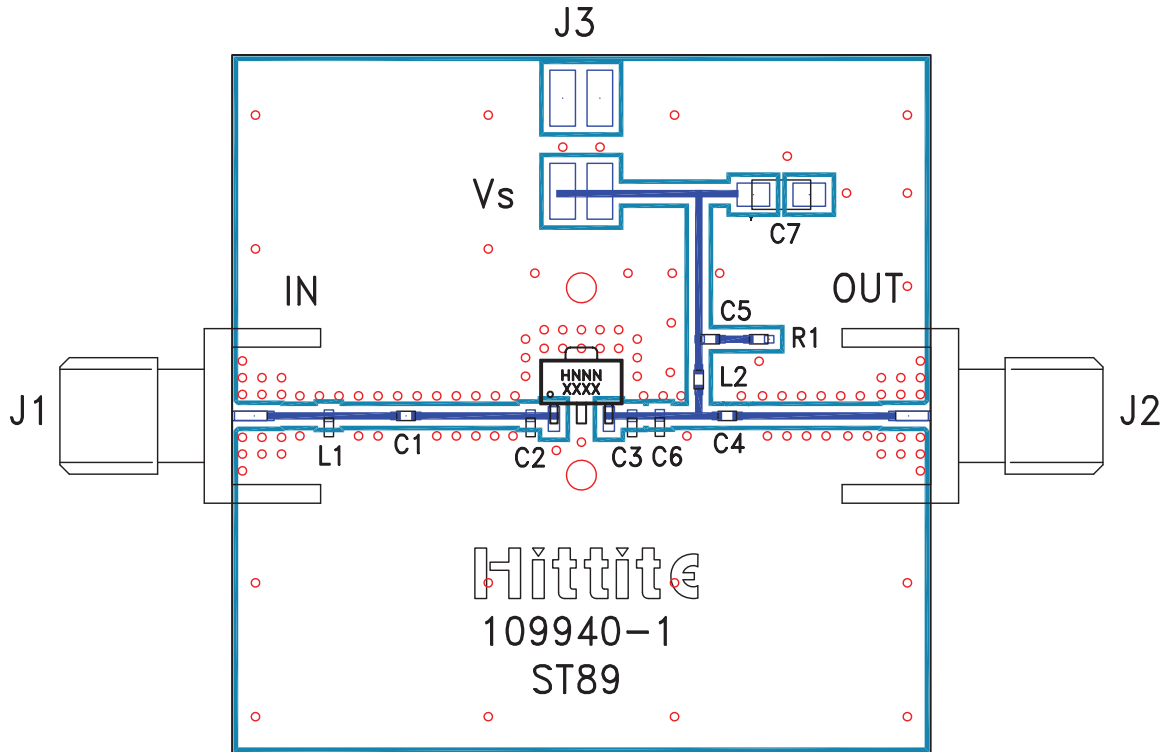

**List of Materials for Evaluation PCB 109942-2100 [1]**

Item	Description
J1 - J2	PCB Mount SMA Connector
J3	2 mm DC Header
C1	0.8 pF Capacitor, 0402 Pkg.
C2	1 pF Capacitor, 0402 Pkg.
C3	3.3 pF Capacitor, 0402 Pkg.
C4	15 pF Capacitor, 0402 Pkg.
C5	100 pF Capacitor, 0402 Pkg.
C6	0.5 pF Capacitor, 0402 Pkg.
C7	2.2 $\mu$ F Capacitor, Tantalum
L1	20 nH Inductor, 0402 Pkg.
L2	12 nH Inductor, 0402 Pkg.
R1	5.1 Ohm Resistor, 0402 Pkg.
U1	HMC453ST89 / HMC453ST89E Linear Amp
PCB [2]	109940 Evaluation PCB, 10 mils

[1] Reference this number when ordering complete evaluation PCB

[2] Circuit Board Material: Rogers 4350, Er = 3.48

The circuit board used in this application should use RF circuit design techniques. Signal lines should have 50 Ohm impedance while the package ground leads and exposed paddle should be connected directly to the ground plane similar to that shown. A sufficient number of via holes should be used to connect the top and bottom ground planes. The evaluation board should be mounted to an appropriate heat sink. The evaluation circuit board shown is available from Hittite upon request.