



IGT™ TRANSISTORS

Insulated Gate Bipolar Transistor

IGT6D11, E11

10 AMPERES
400, 500 VOLTS
EQUIV. R_{DS(ON)} = 0.27 Ω

This IGT™ Transistor (Insulated Gate Bipolar Transistor) is a new type of MOS-gate turn on/off power switching device combining the best advantages of power MOSFETS and bipolar transistors. The result is a device that has the high input impedance of MOSFETS and the low on-state conduction losses similar to bipolar transistors. The device design and gate characteristics of the IGT™ Transistor are also similar to power MOSFETS. An important difference is the equivalent R_{DS(ON)} drain resistance which is modulated to a low value (10 times lower) when the gate is turned on. The much lower on-state voltage drop also varies only moderately between 25°C and 150°C offering extended power handling capability.

The IGT™ Transistor is ideal for many high voltage switching applications operating at low frequencies and where low conduction losses are essential, such as; AC and DC motor controls, power supplies and drivers for solenoids, relays and contactors.

Features:

- Low V_{CE(SAT)} — 2.5V typ @ 10A
- Ultra-fast turn-on — 100 ns typical
- Polysilicon MOS gate — Voltage controlled turn on/off
- High current handling — 10 amps @ 100°C

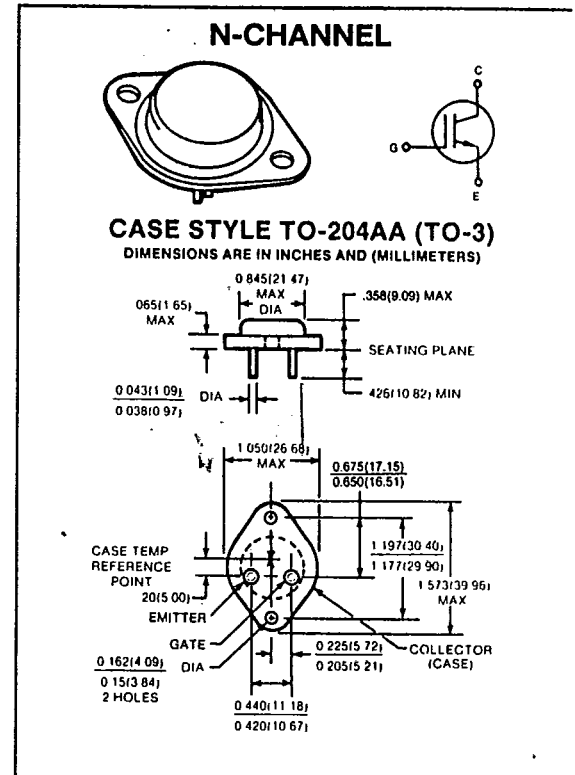

maximum ratings (T_C = 25°C) (unless otherwise specified)

RATING	SYMBOL	IGT6D11	IGT6E11	UNITS
Collector-Emitter Voltage, V _{GE} = 0V	V _{CES}	400	500	Volts
Collector-Gate Voltage, R _{GE} = 1MΩ	V _{CGR}	400	500	Volts
Continuous Drain Current @ T _C = 100°C	I _C	10	10	A
@ T _C = 25°C		18	18	A
Pulsed Collector Current ⁽¹⁾	I _{CM}	40	40	A
Gate-Emitter Voltage	V _{GE}	±25	±25	Volts
Total Power Dissipation @ T _C = 25°C	P _D	75	75	Watts
Derate Above 25°C		0.6	0.6	W/°C
Operating and Storage Junction Temperature Range	T _J , T _{STG}	-55 to 150	-55 to 150	°C

thermal characteristics

Thermal Resistance, Junction to Case	R _{θJC}	1.67	1.67	°C/W
Maximum Lead Temperature for Soldering Purposes: 1/8" from Case for 5 Seconds	T _L	260	260	°C

(1) Repetitive Rating: Pulse width limited by max. junction temperature.

electrical characteristics ($T_C = 25^\circ C$) (unless otherwise specified)

CHARACTERISTIC	SYMBOL	MIN	TYP	MAX	UNIT
----------------	--------	-----	-----	-----	------

off characteristics

Collector-Emitter Breakdown Voltage ($V_{GE} = 0V, I_C = 250\mu A$)	IGT6D11 IGT6E11	BV _{CES}	400 500	— —	— —	Volts
Collector Cut-off Current ($V_{CE} = \text{Max Rating}, V_{GE} = 0V, T_C = 25^\circ C$) ($V_{CE} = \text{Max Rating}, \times 0.8, V_{GE} = 0V, T_C = 150^\circ C$) ⁽²⁾		I _{CES}	— —	— —	250 4.0	μA mA
Gate-Emitter Leakage Current ($V_{GE} = \pm 20V$)		I _{GES}	—	—	±500	nA

(2) Applies for 3.3°C per watt maximum thermal resistance, case to ambient.

on characteristics⁽³⁾

Gate Threshold Voltage ($V_{CE} = V_{GE}, I_C = 250\mu A$)	$T_C = 25^\circ C$ $T_C = 150^\circ C$	V _{GE(TH)}	2 —	4.0 2.5	5 —	Volts
Collector-Emitter Saturation Voltage $I_C = 10 A, T_C = 25^\circ C, V_{GE} = 15V$ $I_C = 10 A, T_C = 150^\circ C, V_{GE} = 15V$ $I_C = 10 A, T_C = 25^\circ C, V_{GE} = 10V$		V _{CE(SAT)}	— — —	2.5 2.8 2.9	2.7 — —	Volts

dynamic characteristics

Input Capacitance	$V_{GE} = 0V$	C _{ies}	—	1050	—	pF
Output Capacitance	$V_{CE} = 25V$	C _{oes}	—	340	—	pF
Reverse Transfer Capacitance	$f = 1 \text{ MHz}$	C _{res}	—	10	—	pF

switching characteristics⁽³⁾ (see figures 8 & 9)

Turn-on Delay Time	Resistive Load, $T_C = 125^\circ C$	t _{d(on)}	—	100	—	ns
Rise Time	$I_C = 10A, V_{CE} = \text{Rated } V_{CES}$	t _r	—	100	—	ns
Turn-off Delay Time	$V_{GE} = 15V$	t _{d(off)}	—	0.4	—	μs
Fall Time	$R_{G(on)} = 50\Omega, R_{GE} = 100\Omega$	t _f	—	2.5	—	μs
Turn-off Delay Time	Inductive Load, $T_C = 125^\circ C,$ $L = 550\mu H, I_C = 10A,$	t _{d(off)}	—	0.8	1.2	μs
Fall Time	$V_{CE(CLAMP)} = \text{Rated } V_{CES}$	t _f	—	0.8	1.0	μs
Equivalent Fall Time	$V_{GE} = 15V$	t _{f(eq)}	—	0.6	0.8	μs
Turn-off Switching Losses	$R_{G(on)} = 50\Omega, R_{GE} = 100\Omega$	E _f	—	1.3 1.6	1.6 2.0	mJ

(3) Pulse test: Pulse widths $\leq 300 \mu sec$, duty cycle $\leq 2\%$.

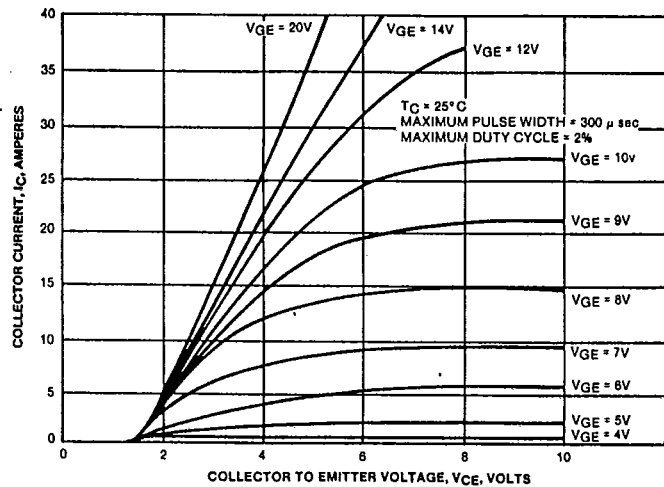

FIGURE 1. TYPICAL OUTPUT CHARACTERISTICS

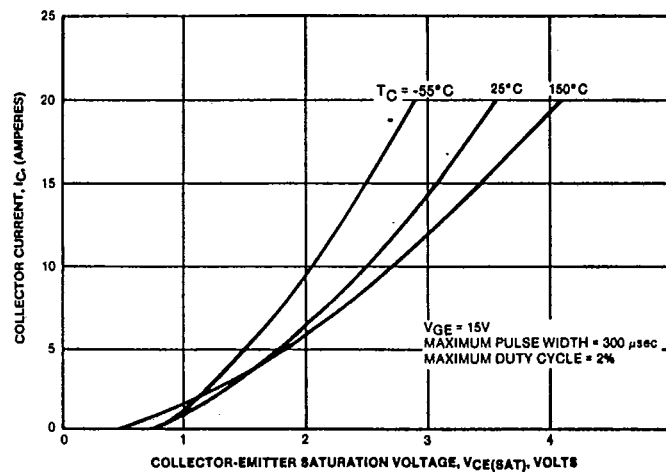

FIGURE 2. TYPICAL COLLECTOR-EMITTER SATURATION VOLTAGE

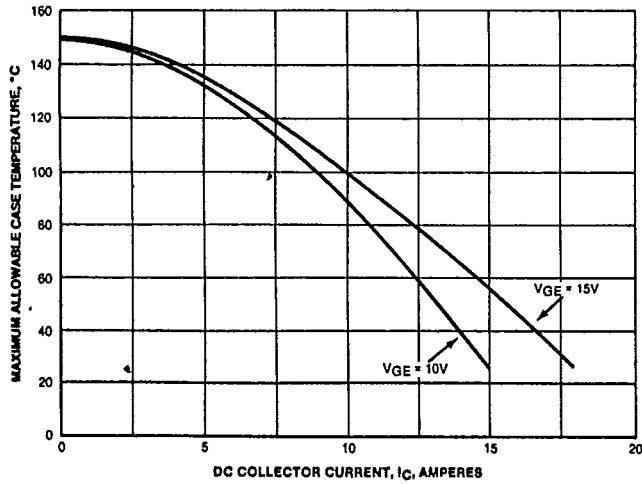

FIGURE 3. MAXIMUM ALLOWABLE CASE TEMPERATURE VS. DC COLLECTOR CURRENT

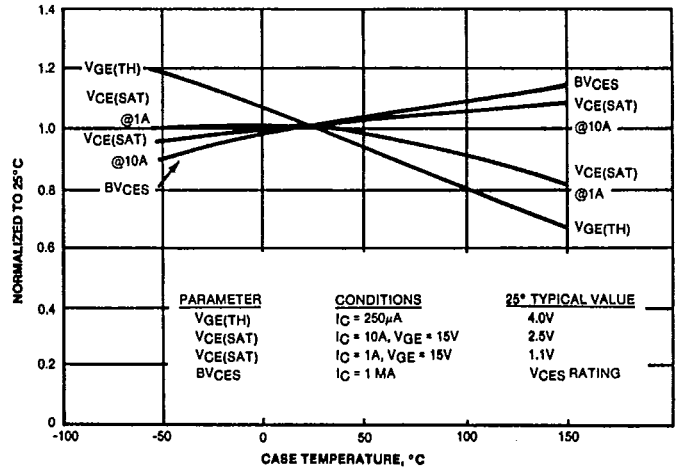

FIGURE 4. TYPICAL TEMPERATURE DEPENDENCE OF PARAMETERS

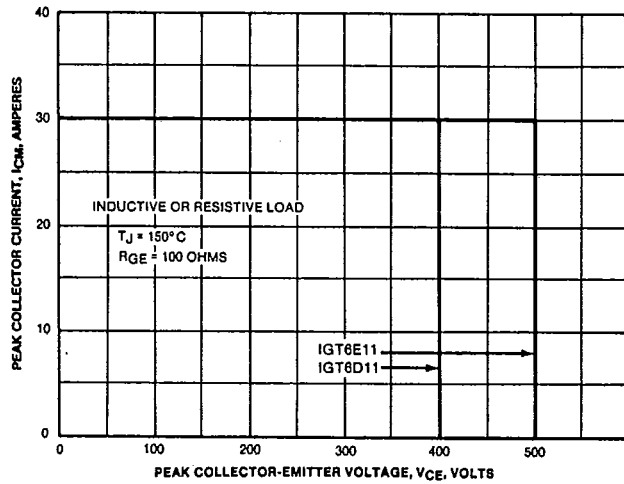

FIGURE 5. TURN-OFF SAFE OPERATING AREA

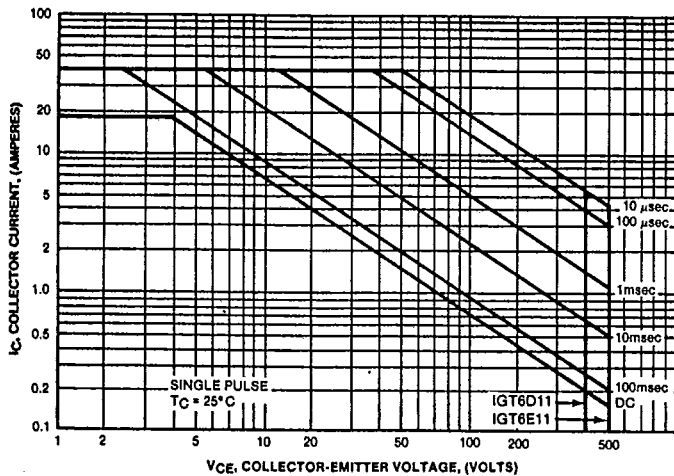

FIGURE 6. TURN-ON SAFE OPERATING AREA

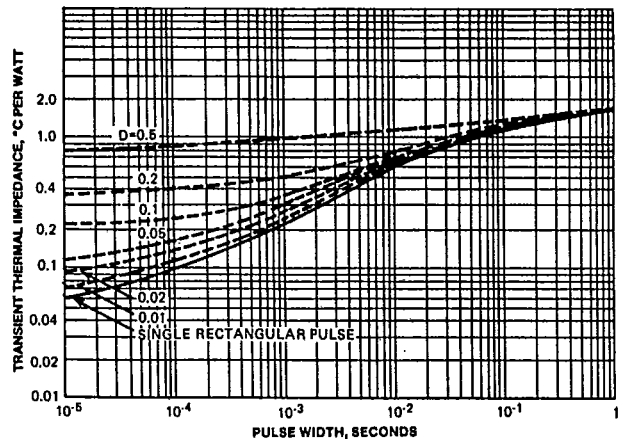
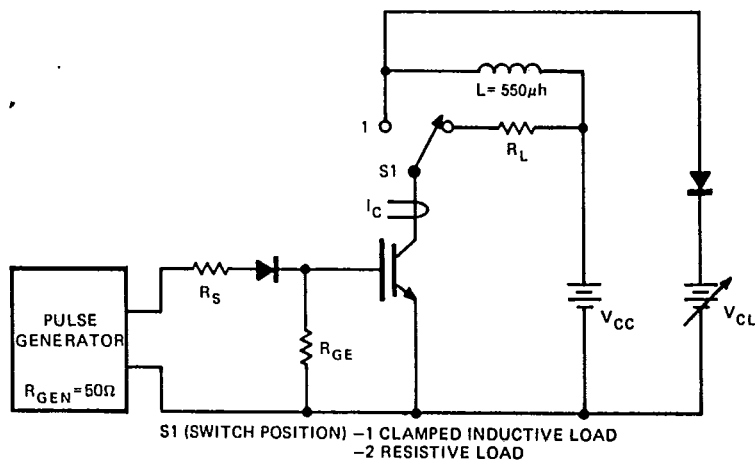
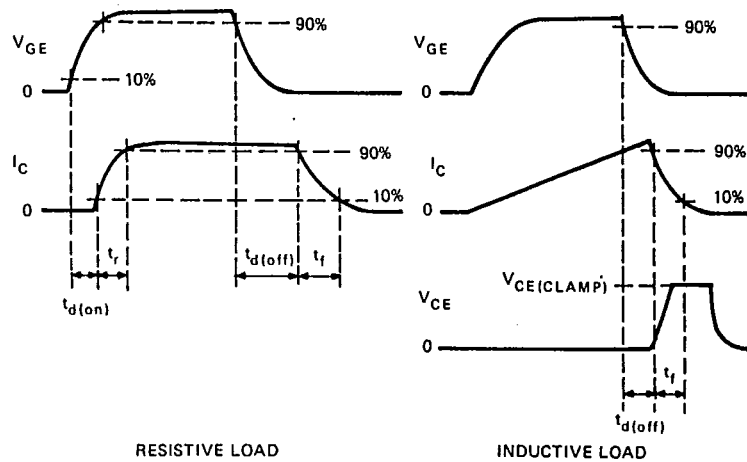

FIGURE 7. MAXIMUM TRANSIENT THERMAL IMPEDANCE



$$R_{G(ON)} = \frac{(R_{GEN} + R_S)(R_{GE})}{R_{GEN} + R_S + R_{GE}}, \text{ PULSE WIDTH} \geq 60\mu\text{sec}, V_{CC} = \frac{L \cdot I_C (\text{MAXIMUM})}{\text{PULSE WIDTH}}$$

FIGURE 8. BASIC SWITCHING TEST CIRCUIT



(WAVEFORMS NOT TO SCALE)

FIGURE 9. SWITCHING WAVEFORMS