

FEATURES

- Advanced New Design
- Advanced Rugged Technology
- Rugged Gate Oxide Technology
- Very Low Intrinsic Capacitances
- Excellent Switching Characteristics
- Unrivalled Gate Charge: 28nC (Typ.)
- Extended Safe Operating Area
- Lower $R_{DS(ON)}$: 0.58Ω (Typ.)

$BV_{DSS} = 500V$
 $R_{DS(ON)} = 0.73\Omega$
 $I_D = 9.6A$

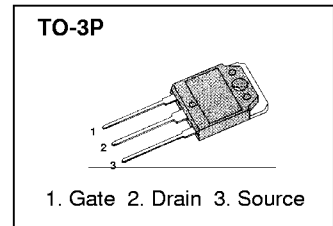

ABSOLUTE MAXIMUM RATINGS

Symbol	Characteristics	Value	Units
V_{DSS}	Drain-to-Source Voltage	500	V
I_D	Continuous Drain Current ($T_C = 25^\circ C$)	9.6	A
	Continuous Drain Current ($T_C = 100^\circ C$)	6.1	
I_{DM}	Drain Current-Pulsed ①	38	V
V_{GS}	Gate-to-Source Voltage	± 30	J
E_{AS}	Single Pulsed Avalanche Energy ②	360	mJ
I_{AR}	Avalanche Current ①	9.6	A
E_{AR}	Repetitive Avalanche Energy ①	16	mJ
dv/dt	Peak Diode Recovery dv/dt ③	4.5	V/ns
P_D	Total Power Dissipation ($T_C = 25^\circ C$)	160	W W/°C
	Linear Derating Factor	1.28	
T_J, T_{STG}	Operating Junction and Storage Temperature Range	-55 to +150	°C
T_L	Maximum Lead Temp. for Soldering Purposes, 1/8" from case for 5-seconds	300	

THERMAL RESISTANCE

Symbol	Characteristics	Typ.	Max.	Units
$R_{\theta JC}$	Junction-to-Case	-	0.78	°C/W
$R_{\theta CS}$	Case-to-Sink	0.24	-	
$R_{\theta JA}$	Junction-to-Ambient	-	40	

ELECTRICAL CHARACTERISTICS ($T_C = 25^\circ\text{C}$ unless otherwise specified)

Symbol	Characteristics	Min.	Typ.	Max.	Units	Test Conditions
BV_{DSS}	Drain-Source Breakdown Voltage	500	–	–	V	$V_{GS}=0V, I_D=250\mu A$
$\Delta BV/\Delta T_J$	Breakdown Voltage Temp. Coeff.	–	0.55	–	V/°C	$I_D=250\mu A$, See Fig 7
$V_{GS(th)}$	Gate Threshold Voltage	3.0	–	5.0	V	$V_{DS}=5V, I_D=250\mu A$
I_{GSS}	Gate-Source Leakage, Forward	–	–	100	nA	$V_{GS}=30V$
	Gate-Source Leakage, Reverse	–	–	–100		$V_{GS}= -30V$
I_{DSS}	Drain-to-Source Leakage Current	–	–	1	μA	$V_{DS}=500V$
		–	–	10		$V_{DS}=400V, T_C=125^\circ\text{C}$
$R_{DS(on)}$	Static Drain-Source On-State Resistance	–	0.58	0.73	Ω	$V_{GS}=10V, I_D=4.8A$ ④
g_{fs}	Forward Transconductance	–	8.4	–	S	$V_{DS}=50V, I_D=4.8A$ ④
C_{iss}	Input Capacitance	–	1100	1450	pF	$V_{GS}=0V, V_{DS}=25V$ $f=1\text{MHz}$ See Fig 5
C_{oss}	Output Capacitance	–	160	210		
C_{rss}	Reverse Transfer Capacitance	–	20	30		
$t_{d(on)}$	Turn-On Delay Time	–	25	60	ns	$V_{DD}=250V, I_D=9.0A$ $R_G=50\Omega$ See Fig 13 ④ ⑤
t_r	Rise Time	–	95	200		
$t_{d(off)}$	Turn-Off Delay Time	–	55	120		
t_f	Fall Time	–	60	130		
Q_g	Total Gate Charge	–	28	36	nC	$V_{DS}=400V, V_{GS}=10V$ $I_D=9.0A$ See Fig 6 & Fig 12 ④ ⑤
Q_{gs}	Gate-Source Charge	–	7.0	–		
Q_{gd}	Gate-Drain (Miller) Charge	–	12.5	–		

SOURCE-DRAIN DIODE RATINGS AND CHARACTERISTICS

Symbol	Characteristics	Min.	Typ.	Max.	Units	Test Conditions
I_S	Continuous Source Current	–	–	9.6	A	Integral reverse pn-diode in the MOSFET
I_{SM}	Pulsed-Source Current ①	–	–	38		
V_{SD}	Diode Forward Voltage ④	–	–	1.4	V	$T_J=25^\circ\text{C}, I_S=9.6A, V_{GS}=0V$
Q_{rr}	Reverse Recovery Time	–	300	–	ns	$T_J=25^\circ\text{C}, I_F=9.0A, V_{DD}=400V$ $di_F/dt=100A/\mu s$ ④
	Reverse Recovery Charge	–	2.2	–	μC	

Notes:

- ① Repetitive Rating: Pulse Width Limited by Maximum Junction Temperature
- ② $L=7\text{mH}, I_{AS}=9.6A, V_{DD}=50V, R_G=25\Omega$, Starting $T_J=25^\circ\text{C}$
- ③ $I_{SD} \leq 9.0A, di/dt \leq 200A/\mu s, V_{DD} \leq BV_{DSS}$, Starting $T_J=25^\circ\text{C}$
- ④ Pulse Test: Pulse Width $\leq 300\mu s$, Duty Cycle $\leq 2\%$
- ⑤ Essentially Independent of Operating Temperature

Fig 1. Output Characteristics

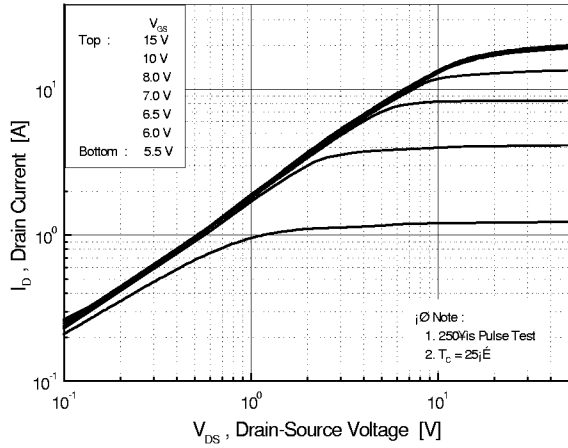

Fig 2. Transfer Characteristics

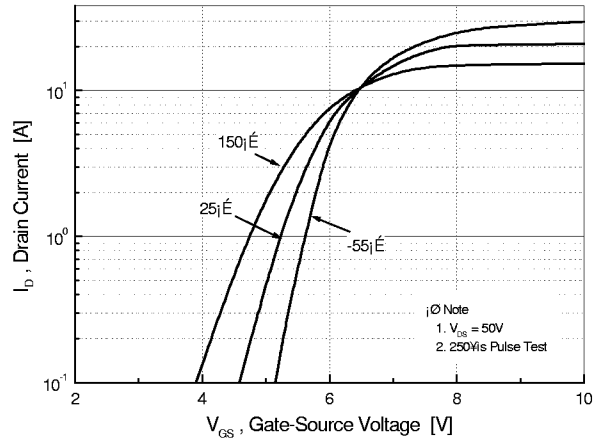

Fig 3. On-Resistance vs. Drain Current

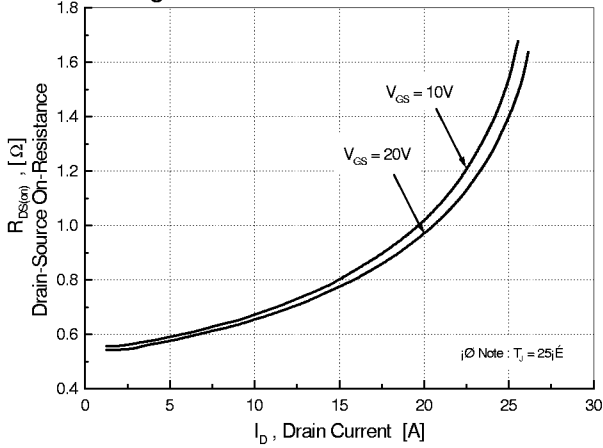

Fig 4. Source-Drain Diode Forward Voltage

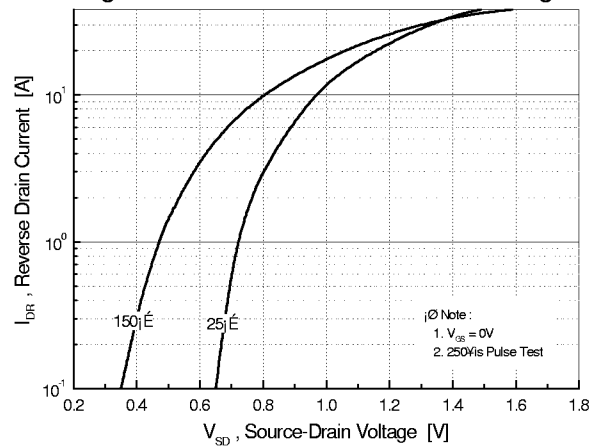

Fig 5. Capacitance vs. Drain-Source Voltage

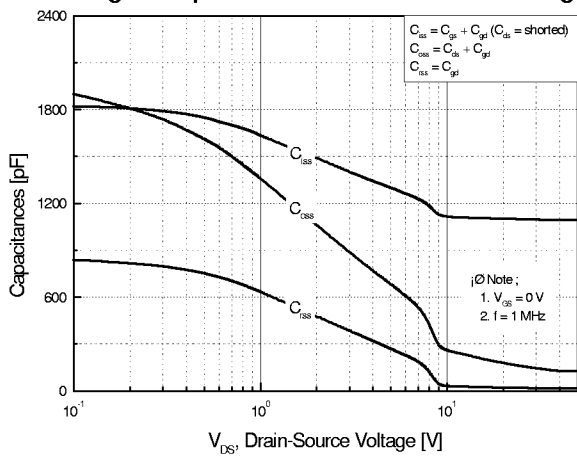

Fig 6. Gate Charge vs. Gate-Source Voltage

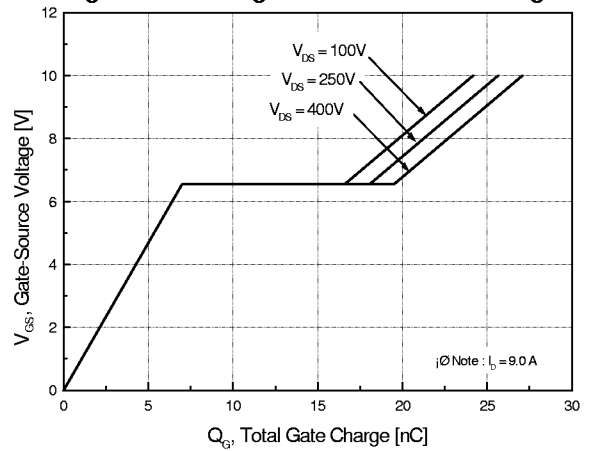

Fig 7. Breakdown Voltage vs. Temperature

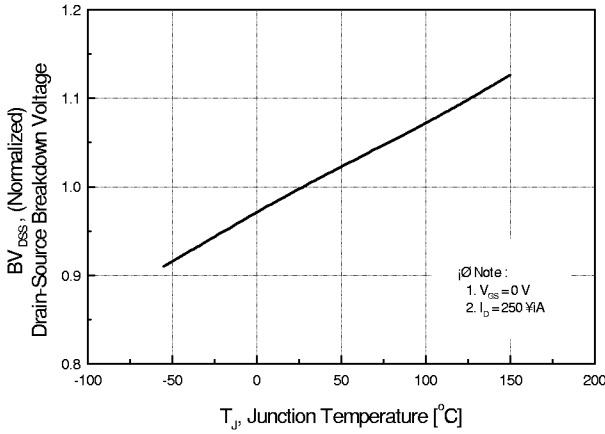

Fig 8. On-Resistance vs. Temperature

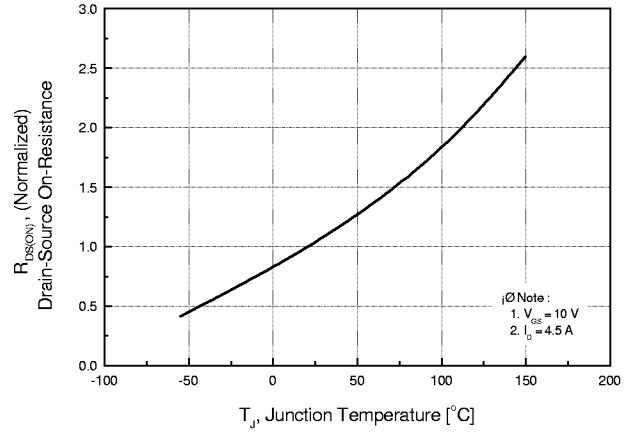

Fig 9. Max. Safe Operating Area

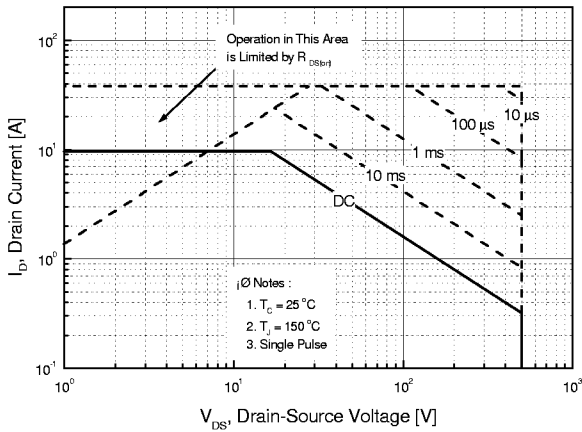

Fig 10. Max. Drain Current vs. Case Temperature

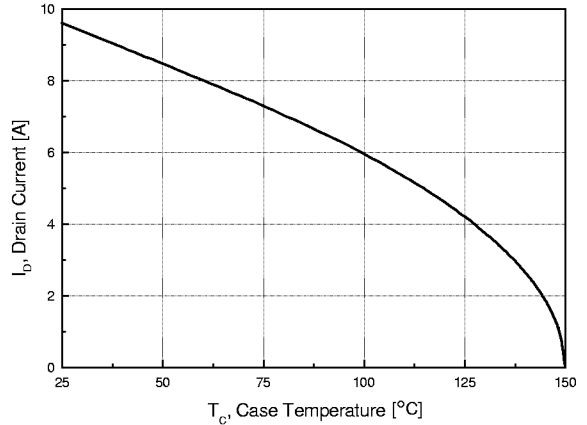

Fig 11. Thermal Response

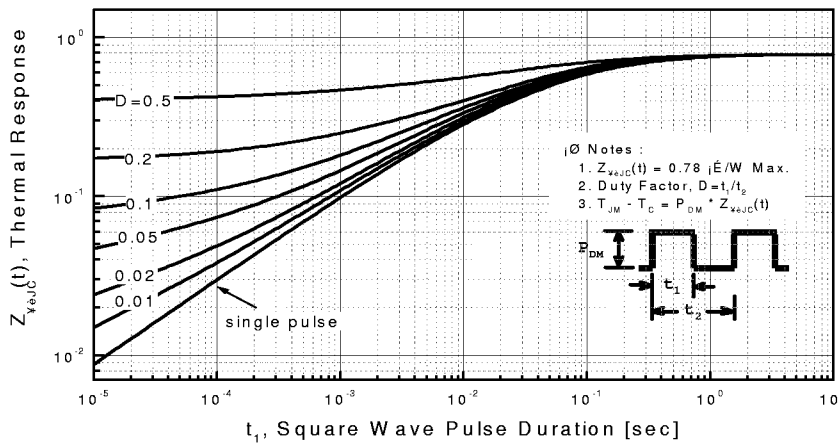

Fig 12. Gate Charge Test Circuit & Waveform

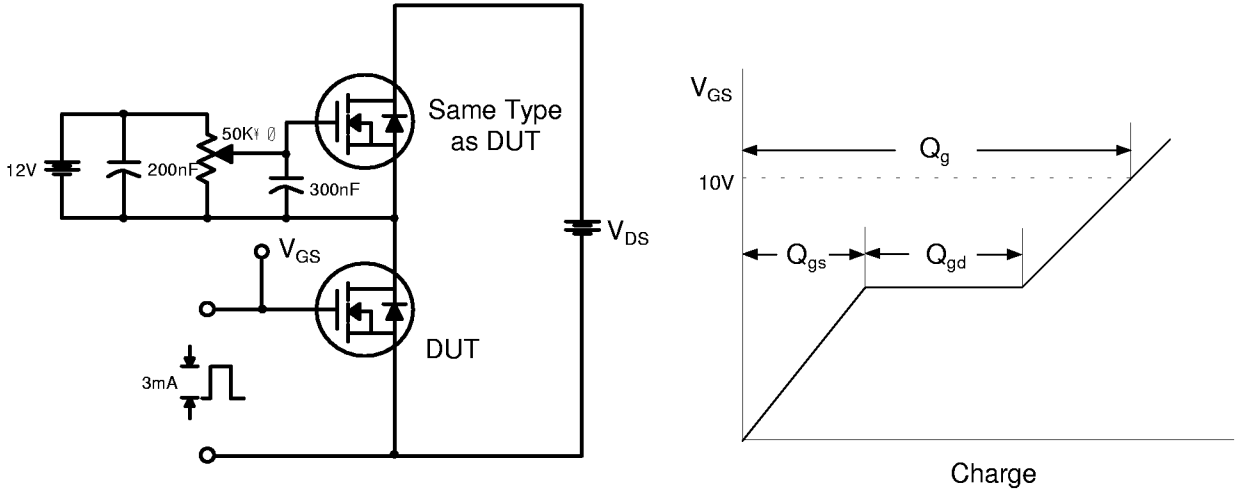

Fig 13. Resistive Switching Test Circuit & Waveforms

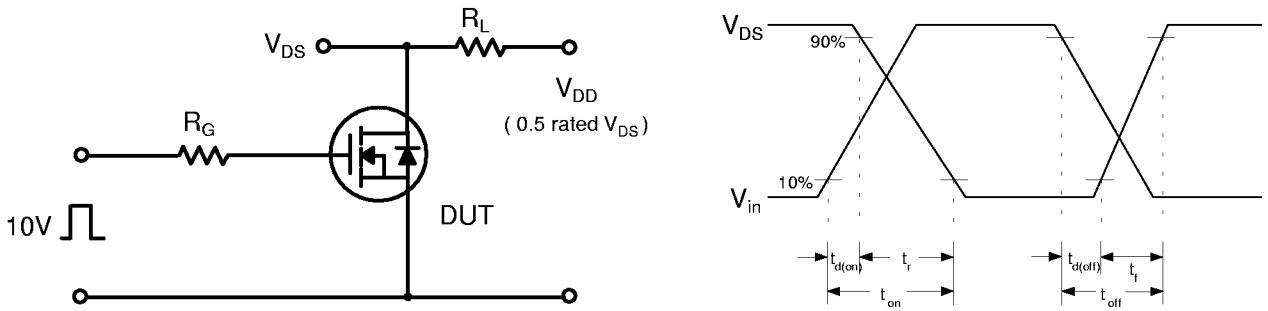

Fig 14. Unclamped Inductive Switching Test Circuit & Waveforms

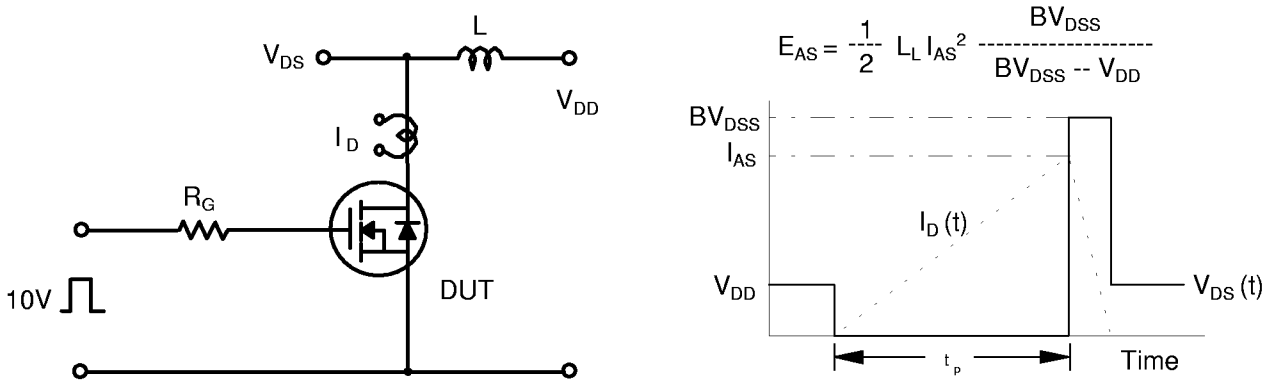

Fig 15. Peak Diode Recovery dv/dt Test Circuit & Waveforms

