

FEATURES

Part of SoundMAX® audio solution for desktop computers
Mono 1.5 W differential or stereo 250 mW output
Single-supply operation: 2.7 V to 6 V
Low shutdown current = 60 μ A
PC99 compliant
Low distortion: 0.2% THD at 1.5 W
Wide bandwidth: 4 MHz
Unity-gain stable

APPLICATIONS

Desktop, portable, and palmtop computers
 Sound cards
 Communication headsets
 2-way communications
 Hand-held games

GENERAL DESCRIPTION

The SSM2250 is intended for use in desktop computers that have basic audio functions. It is also ideal for any audio system that needs to provide both an internal monaural speaker and a stereo line or headphone output. Combined with an AC97 codec, it provides a PC audio system that meets the PC99 requirements. The SSM2250 is compact and requires a minimum of external components.

The SSM2250 features an audio amplifier capable of delivering 1.5 W of low distortion power into a mono 4 Ω bridge-tied load (BTL) or 2 \times 90 mW into stereo 32 Ω single-ended load (SE) headphones. Both amplifiers provide rail-to-rail outputs for maximum dynamic range from a single supply. The balanced output provides maximum output from a 5 V supply and eliminates the need for a coupling capacitor.

The SSM2250 can automatically switch between an internal mono speaker and external headphones. The device can run from a single supply, ranging from 2.7 V to 6 V, with an active supply current of 9 mA typical. The ability to shut down the amplifiers (60 μ A shutdown current) makes the SSM2250 an ideal speaker amplifier for battery-powered applications.

The SSM2250 is specified over the industrial (-40°C to $+85^{\circ}\text{C}$) temperature range. It is available in a 14-lead TSSOP and a 10-lead, surface mount MSOP package.

PIN CONFIGURATIONS

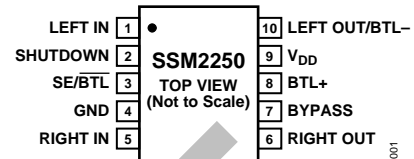

Figure 1. 10-Lead MSOP Pin Configuration (RM Suffix)

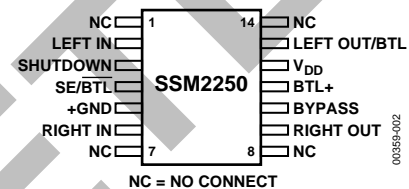

Figure 2. 14-Lead TSSOP Pin Configuration (RU Suffix)

FUNCTIONAL BLOCK DIAGRAM

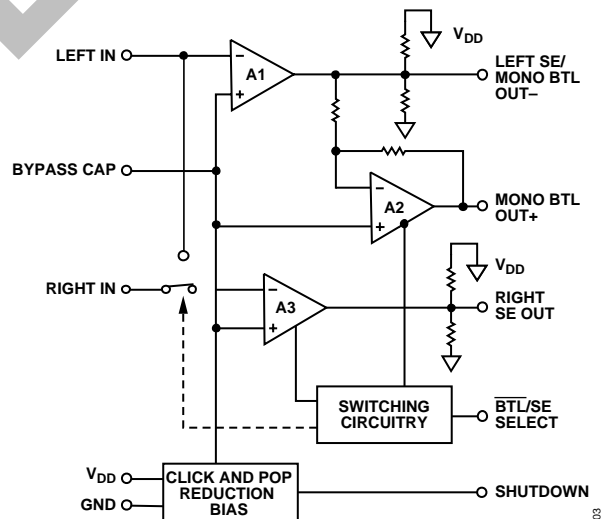

Figure 3.

Rev. A

Information furnished by Analog Devices is believed to be accurate and reliable. However, no responsibility is assumed by Analog Devices for its use, nor for any infringements of patents or other rights of third parties that may result from its use. Specifications subject to change without notice. No license is granted by implication or otherwise under any patent or patent rights of Analog Devices. Trademarks and registered trademarks are the property of their respective owners.

TABLE OF CONTENTS

Features	1	Electrical Characteristics, $V_s = 2.7\text{ V}$	3
Applications	1	Absolute Maximum Ratings	4
General Description	1	ESD Caution	4
Pin Configurations	1	Typical Performance Characteristics	5
Functional Block Diagram	1	Product Overview	7
Revision History	2	Typical Application	7
Specifications	3	Outline Dimensions	12
Electrical Characteristics, $V_s = 5.0\text{ V}$	3	Ordering Guide	12

REVISION HISTORY

6/05—Rev. 0 to Rev. A

Updated Format	Universal
Updated Ordering Guide	12

10/99—Revision 0: Initial Version

OBSOLETE

SPECIFICATIONS

ELECTRICAL CHARACTERISTICS, $V_S = 5.0\text{ V}$

$V_S = 5.0\text{ V}$, $V_{CM} = 2.5\text{ V}$, $T_A = 25^\circ\text{C}$, unless otherwise noted.

Table 1.

Parameter	Symbol	Conditions	Min	Typ	Max	Unit
DEVICE CHARACTERISTICS						
Output Offset Voltage	V_{OS}	BTL mode; $A_V = 2$; BTL+ to BTL-		4	100	mV
Large Signal Voltage Gain	A_{VO}	$R_L = 2\text{ k}\Omega$		2		V/mV
Output Power	P_{OUT}	SE mode: $R_L = 32\ \Omega$, THD < 1% BTL mode: $R_L = 8\ \Omega$, THD < 1%		90		mW
Output Impedance	Z_{OUT}			1,000		mW
				0.1		Ω
SHUTDOWN INPUT						
Input Voltage High	V_{IH}	$I_S < 100\ \mu\text{A}$	2.0			V
Input Voltage Low	V_{IL}	$I_S > 1\text{ mA}$			0.8	V
POWER SUPPLY						
Supply Current	I_S	BTL mode		6.4		mA
		SE mode		6.4		mA
Supply Current/Amplifier	I_S			60		μA
DYNAMIC PERFORMANCE						
Slew Rate	SR	$R_L = 100\text{ k}\Omega$, $C_L = 50\text{ pF}$		4		V/ μs
Gain Bandwidth Product	GBP			4		MHz
Phase Margin	Φ_o			84		Degrees
NOISE PERFORMANCE						
Voltage Noise Density	e_n	$f = 1\text{ kHz}$		45		nV/ $\sqrt{\text{Hz}}$

ELECTRICAL CHARACTERISTICS, $V_S = 2.7\text{ V}$

$V_S = 2.7\text{ V}$, $V_{CM} = 1.35\text{ V}$, $T_A = 25^\circ\text{C}$, unless otherwise noted.

Table 2.

Parameter	Symbol	Conditions	Min	Typ	Max	Unit
DEVICE CHARACTERISTICS						
Output Offset Voltage	V_{OS}	BTL mode; $A_V = 2$; BTL+ to BTL-		4	100	mV
Large Signal Voltage Gain	A_{VO}	$R_L = 2\text{ k}\Omega$		2		V/mV
Output Power	P_{OUT}	SE mode: $R_L = 32\ \Omega$, THD < 1% BTL mode: $R_L = 8\ \Omega$, THD < 1%		25		mW
Output Impedance	Z_{OUT}			300		mW
				0.1		Ω
SHUTDOWN INPUT						
Input Voltage High	V_{IH}	$I_S < 100\ \mu\text{A}$	2.0			V
Input Voltage Low	V_{IL}	$I_S > 1\text{ mA}$			0.8	V
POWER SUPPLY						
Supply Current	I_S	BTL mode		6.4		mA
		SE mode		6.4		mA
Supply Current/Amplifier	I_S			32		μA
DYNAMIC PERFORMANCE						
Slew Rate	SR	$R_L = 100\text{ k}\Omega$, $C_L = 50\text{ pF}$		4		V/ μs
Gain Bandwidth Product	GBP			4		MHz
Phase Margin	Φ_o			84		Degrees
NOISE PERFORMANCE						
Voltage Noise Density	e_n	$f = 1\text{ kHz}$		45		nV/ $\sqrt{\text{Hz}}$

SSM2250

ABSOLUTE MAXIMUM RATINGS

Table 3.

Parameter	Rating
Supply Voltage	6 V
Differential Input Voltage ¹	±5 V
Common-Mode Input Voltage	±6 V
ESD Susceptibility	2000 V
Storage Temperature Range	
All Packages	–65°C to +150°C
Operating Temperature Range	
All Packages	–40°C to +85°C
Junction Temperature Range	
All Packages	–65°C to +165°C
Lead Temperature Range (Soldering, 60 sec)	300°C

¹ Differential input voltage or ±V_s, whichever is lower.

ESD CAUTION

ESD (electrostatic discharge) sensitive device. Electrostatic charges as high as 4000 V readily accumulate on the human body and test equipment and can discharge without detection. Although this product features proprietary ESD protection circuitry, permanent damage may occur on devices subjected to high energy electrostatic discharges. Therefore, proper ESD precautions are recommended to avoid performance degradation or loss of functionality.

Stresses above those indicated under Absolute Maximum Ratings may cause permanent damage to the device. This is a stress rating only; functional operation of the device at these or any other conditions above those indicated in the operational section of this specification is not implied. Exposure to absolute maximum rating conditions for extended periods may affect device reliability.

Table 4.

Package Type	θ_{JA} ¹	θ_{JC}	Unit
10-Lead MSOP (RM)	200	44	°C/W
14-Lead TSSOP (RU)	180	35	°C/W

¹ θ_{JA} is specified for worst-case conditions; that is, θ_{JA} is specified for the device soldered in circuit board for surface mount packages.



TYPICAL PERFORMANCE CHARACTERISTICS

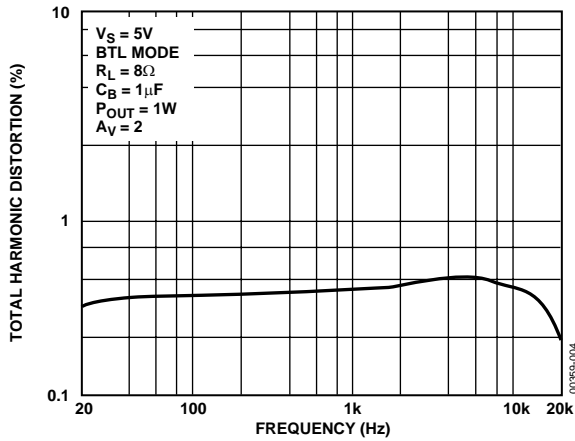

Figure 4. BTL Out THD + N vs. Frequency

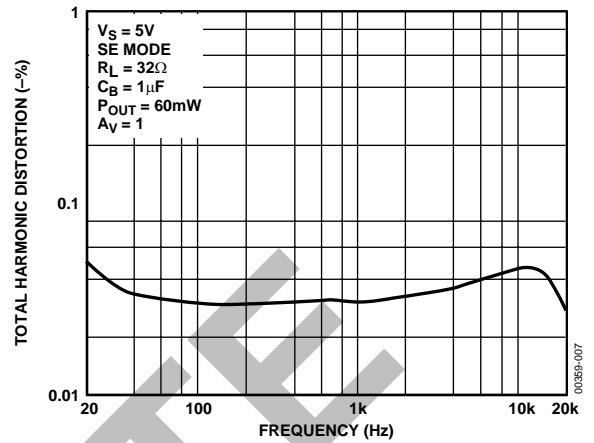

Figure 7. SE Out THD + N vs. Frequency

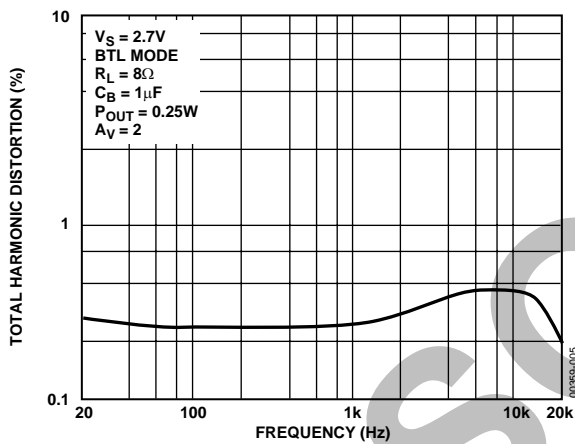

Figure 5. BTL Out THD + N vs. Frequency

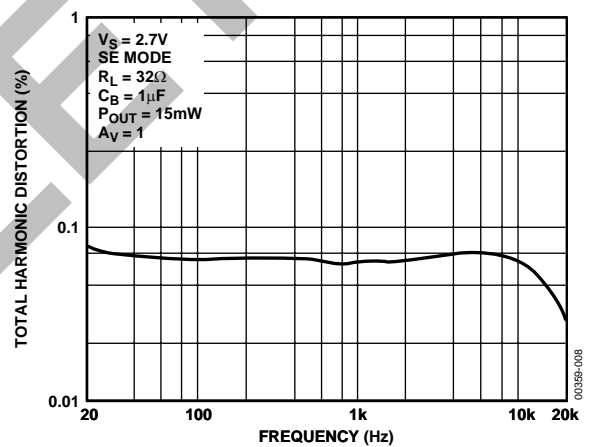

Figure 8. SE Out THD + N vs. Frequency

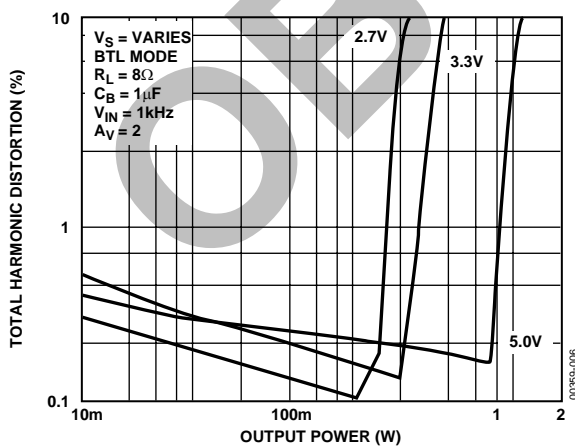

Figure 6. THD + N vs. Output Power

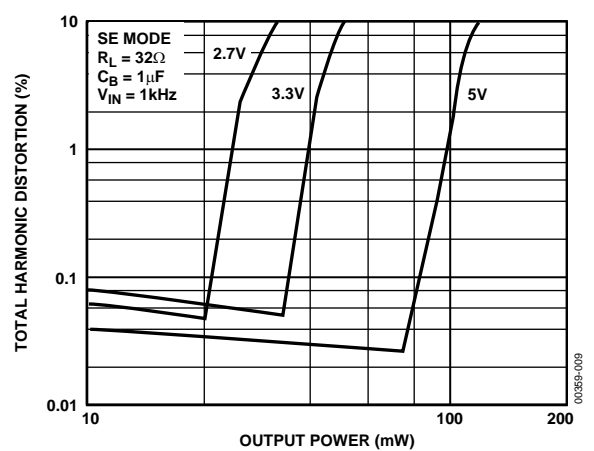

Figure 9. BTL Out THD + N vs. Output Power

SSM2250

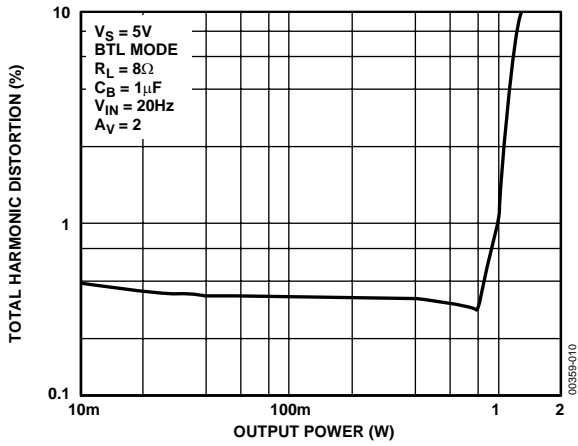

Figure 10. BTL Out THD + N vs. Output Power at 20 Hz

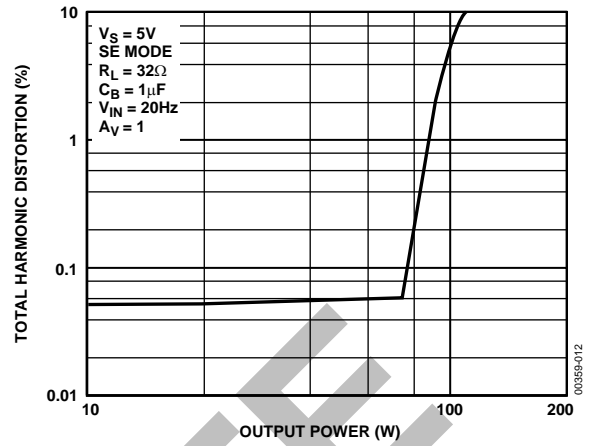

Figure 12. SE Out THD + N vs. Output Power at 20 Hz

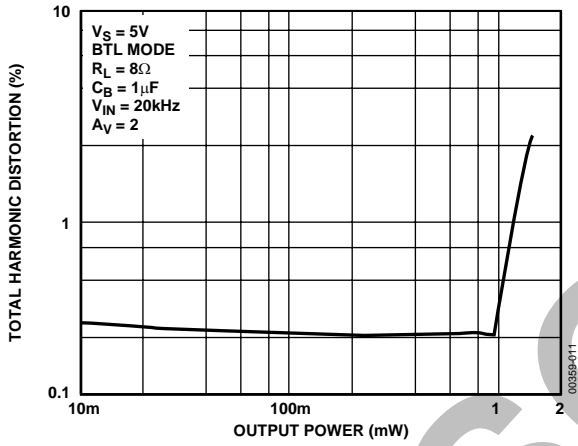

Figure 11. BTL Out THD + N vs. Output Power at 20 kHz

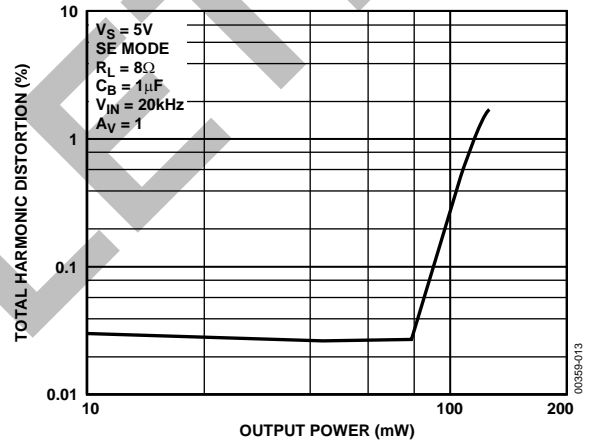

Figure 13. SE Out THD + N vs. Output Power at 20 kHz

PRODUCT OVERVIEW

The SSM2250 is a low distortion power amplifier that can drive a set of stereo headphones or a single 8 Ω loudspeaker. It contains three rail-to-rail output op amps, click-and-pop reduction biasing, and all necessary switching circuitry. In SE (single-ended) mode, the device automatically mutes the internal 8 Ω speaker. In BTL (bridge-tied load) mode, the internal speaker is activated.

The SSM2250 can operate from a 2.7 V to a 5.5 V single supply. The rail-to-rail outputs can be driven to within 400 mV of either supply rail while supplying a sustained output current of 350 mA into 8 Ω. The device is unity-gain stable and requires no external compensation capacitors. The SSM2250 can be configured for gains of up to 40 dB.

TYPICAL APPLICATION

In SE mode, the device operates similarly to a high current output, dual op amp. A1 and A3 are independent amplifiers with a gain of $-R2/R1$. The outputs of A1 and A3 are used to drive the external headphones plugged into the headphone jack. Amplifier A2 is shut down to a high output impedance state. This prevents current from flowing through the 8 Ω internal speaker, thereby muting it.

Although the gains of A1 and A3 can be set independently, it is recommended that the feedback and feedforward resistor around both amplifiers be equal. This prevents one channel from becoming louder than the other.

In BTL mode, the current into the right in pin is directed to the input of A1. This effectively sums the left in and right in audio signals. The A2 amplifier is activated and configured with a fixed gain of $A_v = -1$. This produces a balanced output configuration that drives the internal speaker. Because the BTL output voltages swing opposite to each other, the gain to the speaker in BTL mode is twice the gain of SE mode. The voltage across the internal speaker can be written

$$V_{SPEAKER} = (V_{LEFT} + V_{RIGHT}) \times 2 \times \frac{R2}{R1} \quad (1)$$

The bridged output configuration offers the advantage of a more efficient power transfer from the input to the speaker. Because both outputs are symmetric, the dc voltage bias across the 8 Ω internal speaker is 0. This eliminates the need for a coupling capacitor at the output. In BTL mode, the A3 amplifier is shut down to conserve power.

In BTL mode, the SSM2250 can achieve 1 W continuous output into 8 Ω at ambient temperatures up to 40°C. The power derating curve shown in Figure 17 should be observed for proper operation at higher ambient temperatures. For a standard 14-lead TSSOP package, typical junction-to-ambient temperature thermal resistance (θ_{JA}) is 180°C/W on a 2-layer board and 140°C/W on a 4-layer board.

Internal Speaker/External Headphones Automatic Switching

Pin 4 on the SSM2250 controls the switching between the BTL mode and the SE mode. Logic low to Pin 4 activates BTL mode, while logic high activates SE mode. The configuration shown in Figure 14 provides the appropriate logic voltages to Pin 4, muting the internal speaker when headphones are plugged into the jack.

A stereo headphone jack with a normalizing pin is required for the application. With no plug inserted, a mechanical spring connects the normalizing pin to the output pin in the jack. Once a plug is inserted, this connection is broken.

In Figure 14, Pin 4 of the SSM2250 is connected to the normalizing pin for the right channel output. This pin, located in the headphone jack, hits the ring on the headphone plug. A 100 kΩ pull-up resistor to 5 V is also connected at this point.

With a headphone plug inserted, the normalizing pin disconnects from the output pin, and Pin 4 is pulled up to 5 V, activating SE mode on the SSM2250. This mutes the internal speaker while driving the stereo headphones.

Once the headphone plug is removed, the normalizing pin connects to the output pin. This drives the voltage at Pin 4 to 50 mV, as this point is pulled low by the 1 kΩ resistor now connected to the node. The SSM2250 goes into BTL mode, deactivating the right SE amplifier to prevent the occurrence of any false mode switching.

It is important to connect Pin 4 and the 100 kΩ pull-up resistor to the normalizing pin for the right output in the headphone jack. Connecting them to the left output normalizing pin results in improper operation from the device. The normalizing pin to the left output in the headphone jack should be left open.

Coupling Capacitors

Output coupling capacitors are not required to drive the internal speaker from the BTL outputs. However, coupling capacitors are required between the amplifier's SE outputs and the headphone jack to drive external headphones. This prevents dc current from flowing through the headphone speakers, whose resistances are typically about 80 Ω.

SSM2250

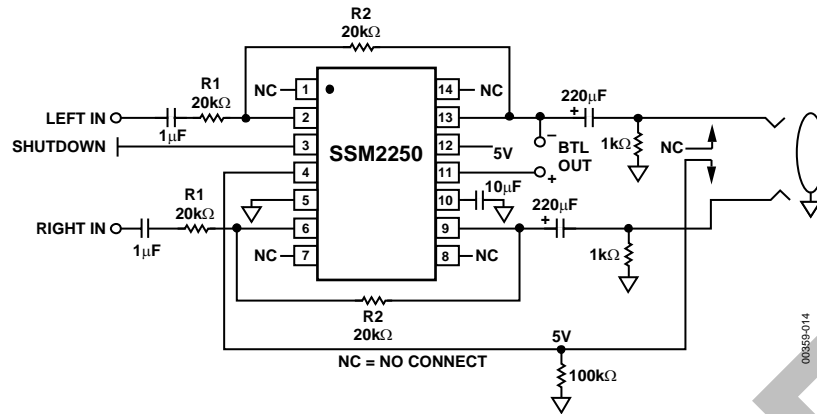

Figure 14. Typical Application

The output coupling capacitor creates a high-pass filter with a cutoff frequency of

$$f_{-3dB} = \frac{1}{2\pi R_L C_C} \quad (2)$$

where:

R_L is the resistance of the headphone.

C_C is the output coupling capacitor.

Although a majority of headphones have approximately 80 Ω of resistance, the resistance can vary between models and manufacturers. Headphone resistances are commonly between 32 Ω to 600 Ω . Using a 220 μF capacitor, as shown in Figure 14, the worst-case -3 dB corner frequency would be 22 Hz, with a 32 Ω headphone load. Smaller output capacitors could be used at the expense of low frequency response to the headphones.

An input coupling capacitor should be used to remove dc bias from the inputs to the SSM2250. Again, the input coupling capacitor in combination with the input resistor creates a high-pass filter with a corner frequency of

$$f_{-3dB} = \frac{1}{2\pi R_1 C_1} \quad (3)$$

Using the values shown in Figure 14, where $R_1 = 20 \text{ k}\Omega$ and $C_1 = 1 \mu\text{F}$, creates a corner frequency of 8 Hz. This is acceptable, as the PC99 audio requirement specifies the computer audio system bandwidth to be 20 Hz to 20 kHz.

Pin 10 on the SSM2250 provides the proper bias voltage for the amplifiers. A 0.1 μF capacitor should be connected here to reduce sensitivity to noise on the power supply. A larger capacitor can be used if more rejection from power supply noise is required.

The SSM2250 has excellent phase margin and is stable even under heavy loading. Therefore, a feedback capacitor in parallel with R_2 is not required, as it is in some competitors' products.

Power Dissipation

An important advantage in using a bridged output configuration is that bridged output amplifiers are more efficient than single-ended amplifiers in delivering power to a load.

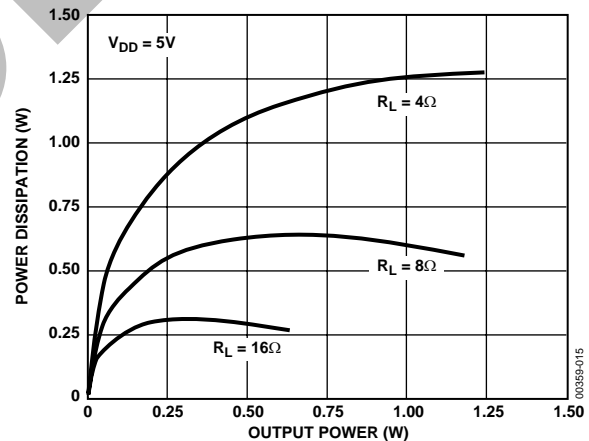

Figure 15. Power Dissipation vs. Output Power in BTL Mode

$$P_{DISS,MAX} = \frac{2V_{DD}^2}{\pi^2 R_L} \quad (4)$$

Using Equation 4 and the power derating curve in Figure 17, the maximum ambient temperature can be easily found. This ensures that the SSM2250 does not exceed its maximum junction temperature of 150°C.

The power dissipation for a single-ended output application where an output coupling capacitor is used is shown in Figure 16.

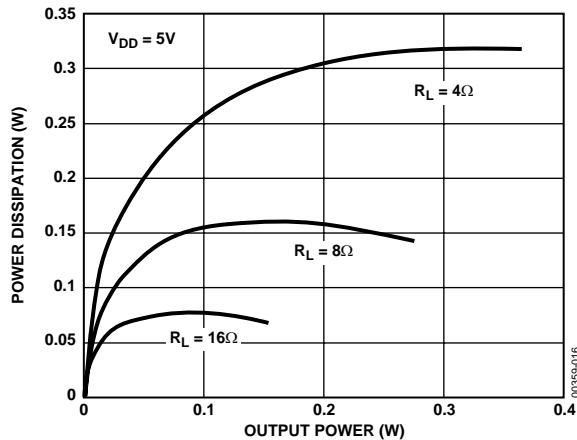

Figure 16. Power Dissipation vs. Single-Ended Output Power ($V_{DD} = 5 V$)

The maximum power dissipation for a single-ended output is

$$P_{DISS, MAX} = \frac{V_{DD}^2}{2\pi^2 R_L} \quad (5)$$

Because the SSM2250 is designed to drive two single-ended loads simultaneously, the worst-case maximum power dissipation in SE mode is twice the value of Equation 5.

A thorough mathematical explanation behind Equation 4 and Equation 5 is provided in the [SSM2211](#) data sheet.

Example

Given worst-case stereo headphone loads of 32Ω , the maximum power dissipation of the SSM2250 in SE mode with a 5 V supply is

$$P_{DISS, MAX} = \frac{(5 V)^2}{2\pi^2 32 \Omega} = 79 mW \quad (6)$$

With an 8Ω internal speaker attached, the maximum power dissipation in BTL mode is (from Equation 4)

$$P_{DISS, MAX} = \frac{2 \times (5 V)^2}{\pi^2 8 \Omega} = 633 mW \quad (7)$$

It can easily be seen that power dissipation from BTL mode operation is of greater concern than SE mode.

Solving for Maximum Ambient Temperature

To protect the SSM2250 against thermal damage, the junction temperature of the die should not exceed 150°C . The maximum allowable ambient temperature of the application can be easily found by solving for the expected maximum power dissipation in Equation 4 and Equation 5, and using Equation 8.

Continuing from the previous example, the θ_{JA} of the SSM2250 14-lead TSSOP package on a 4-layer board is $140^\circ\text{C}/\text{W}$. To ensure that the SSM2250 die junction temperature stays below 150°C , the maximum ambient temperature can be solved using Equation 8.

$$\begin{aligned} T_{AMB, MAX} &= +150^\circ\text{C} - \theta_{JA} \times P_{DISS, MAX} \\ &= +150^\circ\text{C} - (140^\circ\text{C}/\text{W} \times 0.633 \text{ W}) \\ &= +61^\circ\text{C} \end{aligned} \quad (8)$$

The maximum ambient temperature must remain below 61°C to protect the device against thermal damage.

Another method for finding the maximum allowable ambient temperature is to use the power derating curve in Figure 17. The y-axis corresponds to the expected maximum power dissipation, and the x-axis is the corresponding maximum ambient temperature. Either method returns the same answer.

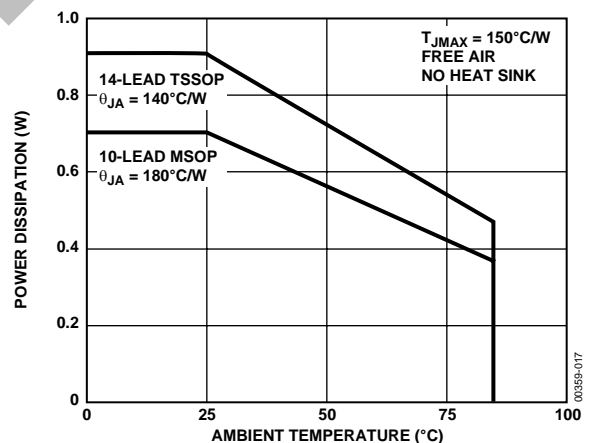

Figure 17. Maximum Power Dissipation vs. Ambient Temperature

Maximum Output Power

The maximum amount of power that can be delivered to a speaker is a function of the supply voltage and the resistance of the speaker. Figure 17 shows the maximum BTL output power possible from the SSM2250. Maximum output power is defined as the point at which the output has greater than 1% distortion.

SSM2250

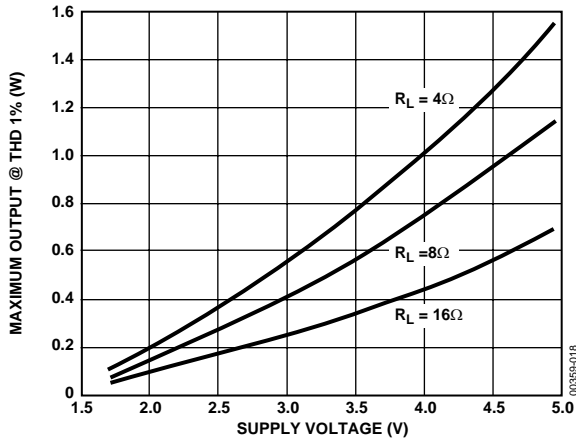

Figure 18. Maximum BTL Output Power vs. V_s

Use Figure 18 to find the minimum supply voltage needed to achieve a specified maximum undistorted output power.

The output power in SE mode is exactly one-fourth the equivalent output power in BTL mode. This is because twice the voltage swing across the two BTL outputs results in $4 \times$ the power delivered to the load. Figure 19 shows the maximum output power in SE mode vs. supply voltage for various headphone loads.

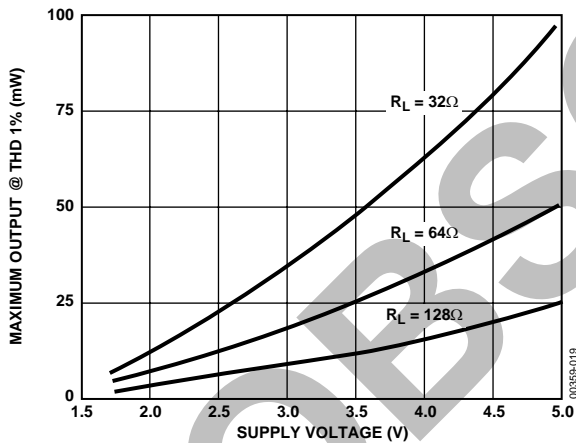

Figure 19. Maximum SE Output Power vs. V_s

Example

An application requires only 500 mW to be output in BTL mode into an 8Ω speaker. By inspection, the minimum supply voltage required is 3.3 V.

Speaker Efficiency and Loudness

The effective loudness of 1 W of power delivered into an 8Ω speaker is a function of the efficiency of the speaker. The efficiency of a speaker is typically rated at the sound pressure level (SPL) at 1 meter in front of the speaker with 1 W of power applied to the speaker. Most speakers are between 85 dB and 95 dB SPL at one meter at 1 W of power. Table 5 shows a comparison of the relative loudness of different sounds.

Table 5. Typical Sound Pressure Levels

Source of Sound	dB SPL
Threshold of Pain	120
Heavy Street Traffic	95
Cabin of Jet Aircraft	80
Average Conversation	65
Average Home at Night	50
Quiet Recording Studio	30
Threshold of Hearing	0

It can easily be seen that 1 W of power into a speaker can produce quite a bit of acoustic energy.

Shutdown Feature

The SSM2250 can be put into a low power consumption shutdown mode by connecting Pin 3 to V_{DD} . In shutdown mode, the SSM2250 has low supply current of 60 μ A.

Pin 3 should be connected to ground for normal operation. Connecting Pin 3 to V_{DD} shuts down all amplifiers and puts all outputs into a high impedance state, effectively muting the SSM2250. A pull-up or pull-down resistor is not required. Pin 3 should never be left floating, as this could produce unpredictable results.

PC99-Compliant Computer Audio Reference Design

The schematic shown in Figure 20 is a reference design for a complete audio system in a computer. The design is compliant with the PC99 standard for computer audio.

The AD1881A is an AC'97, version 2.1, audio codec, available from Analog Devices. The stereo output from the AD1881A is coupled into the SSM2250, which is used to drive a mono internal speaker and stereo headphones. The internal speaker switching is controlled by the SSM2250 through the normalizing pin on the headphone jack. The AD1881A controls the shutdown pin on the SSM2250, and is activated through the power management software drivers installed on the computer.

For more information, refer to the AD1881A data sheet.

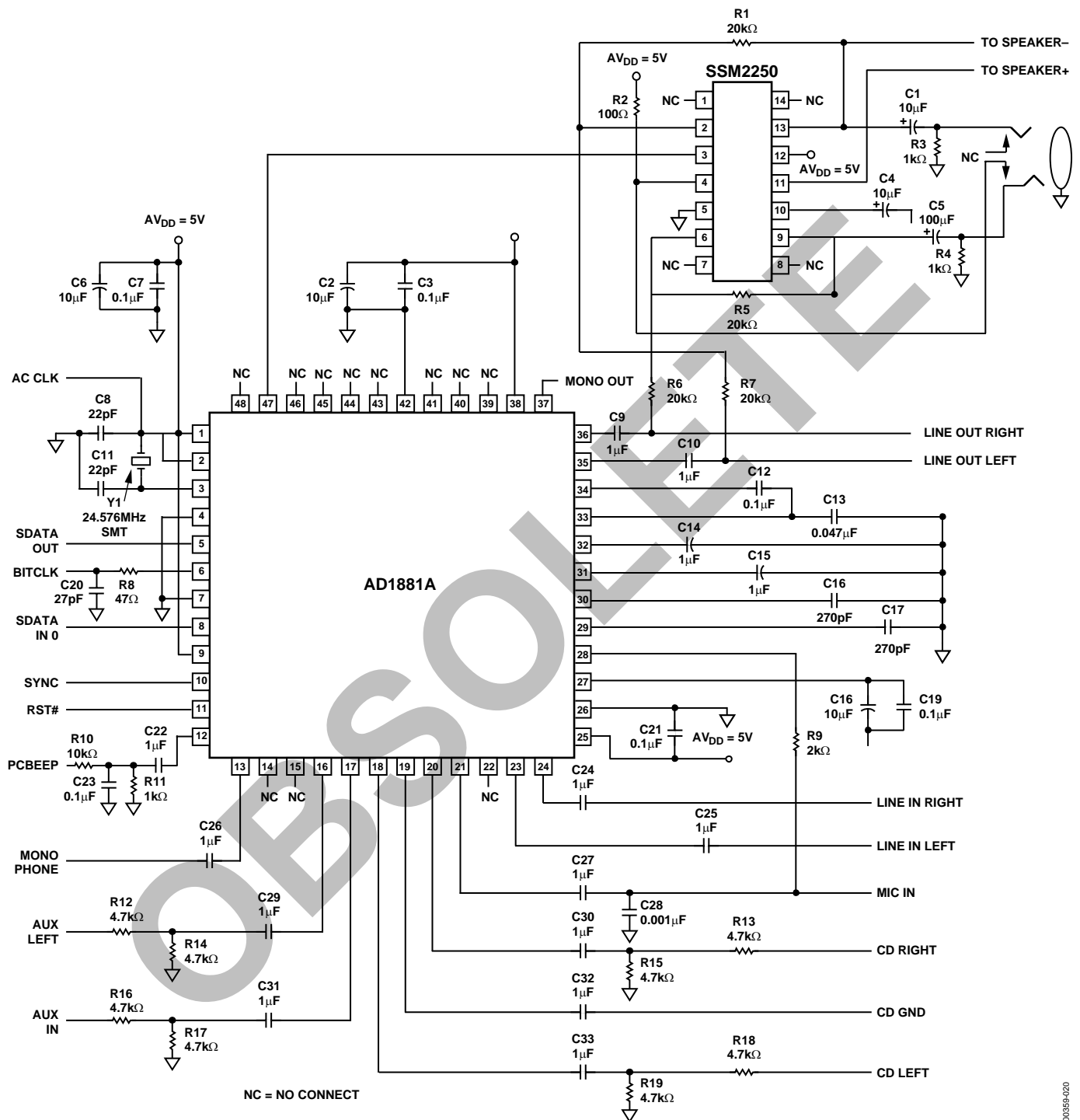
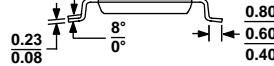
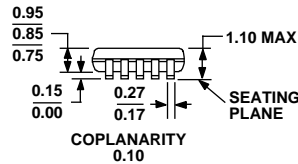
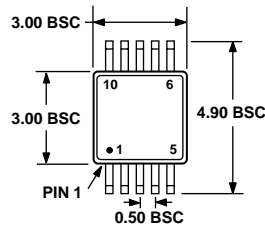

Figure 20. PC99 Compliant Audio System Reference Design

SSM2250

OUTLINE DIMENSIONS



COMPLIANT TO JEDEC STANDARDS MO-187-BA

Figure 21. 10-Lead Mini Small Outline Package [MSOP] (RM-10)
Dimensions shown in millimeters

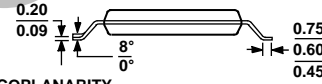
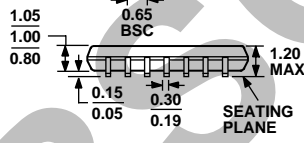
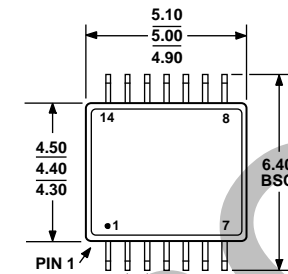

COMPLIANT TO JEDEC STANDARDS MO-153-AB-1

Figure 22. 14-Lead Thin Shrink Small Outline Package [TSSOP] (RU-14)
Dimensions shown in millimeters

ORDERING GUIDE

Model	Temperature Range	Package Description	Package Option	Branding
SSM2250RM-R2	-40°C to +85°C	10-Lead MSOP	RM-10	AK
SSM2250RM-REEL	-40°C to +85°C	10-Lead MSOP	RM-10	AK
SSM2250RMZ-R2 ¹	-40°C to +85°C	10-Lead MSOP	RM-10	AK#
SSM2250RMZ-REEL ¹	-40°C to +85°C	10-Lead MSOP	RM-10	AK#
SSM2250RU-REEL	-40°C to +85°C	14-Lead TSSOP	RU-14	
SSM2250RUZ-REEL ¹	-40°C to +85°C	14-Lead TSSOP	RU-14	

¹ Z = Pb-free part, # denotes Pb-free part; may be top or bottom marked.