

FEATURES

Ultrastable Unity Gain Bandwidth (100MHz)
Bandwidth Is Independent of Gain Settings
18ns Settling to 0.1%
Low Power Dissipation (630mW)
Complete Overdrive Protection
**Low Distortion (THD: -59dBc @ 20MHz,
 -78dBc @ 5MHz, -100dBc @ 10kHz)**

Excellent DC Specifications

Available Processed to MIL-STD 883

APPLICATIONS

Driving Flash Converters
High Speed DAC I/V Converters
Radar, IF Processors
Broadband, Digital Radio
Photodiode Preamps (FLIR)
ATE/Pulse Generators
Imaging/Display Drivers



GENERAL DESCRIPTION

The AD9610 is a fast settling, wide bandwidth, dc coupled, operational amplifier which combines superior dc specifications and exceptional dynamic performance with impeccable spectral purity (harmonic distortion, intermodulation distortion, noise, etc.) over the full bandwidth. This combination provides remarkable versatility and utility for high speed designers.

Thin-film technology and innovative design techniques help assure stable operation over the complete operating temperature range. Input offset voltage is $\pm 0.3\text{mV}$, with $5\mu\text{V}/^\circ\text{C}$ drift; input bias currents are $\pm 15\mu\text{A}$ with $\pm 30\text{nA}/^\circ\text{C}$ drift.

Unique internal architecture employing current feedback keeps the AD9610 inherently stable over its complete gain range and assures wide bandwidth at all gain settings. With $G = -1$, -3dB bandwidth is 120MHz; with $G = -10$, -3dB bandwidth is 100MHz. When $G = -50$, the -3dB bandwidth is 60MHz. Slew rate, fall time and settling time are also independent of gain.

Frequency domain performance for the AD9610 is unmatched. The part can be used in applications requiring wide spurious free dynamic range. At 10kHz total harmonic distortion (THD) is -100dBc; at 1MHz the THD is -85dBc; at 20MHz the THD is -59dBc. Third order intermodulation distortion is similarly impressive, which is often required in communications applications.

FUNCTIONAL BLOCK DIAGRAM

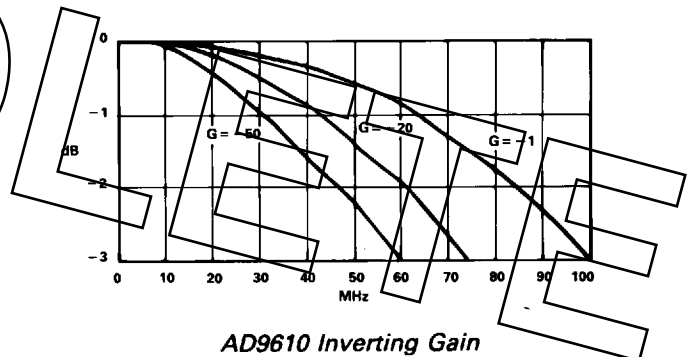
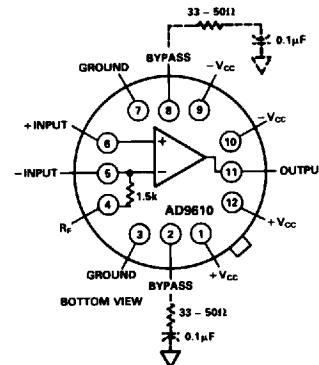

The design of the AD9610 makes it easy to apply. The unit requires no external compensation. An internal 1.5kΩ feedback resistor is available to the user by connecting Pin 4 to Pin 11. This resistor is trimmed for gain accuracy and should be used when the full bandwidth of the amplifier is required. To achieve higher gains, and for lower bandwidth applications, an external resistor can be used. Pins 2 and 8 are bypass pins and should be connected to ground through 33 - 50Ω resistors and 0.1μF ceramic capacitors; effective decoupling of the power supplies is also important to obtain optimum high frequency performance.

Two temperature ranges are available. The AD9610BH is guaranteed over a case temperature range of -25°C to $+85^\circ\text{C}$; the AD9610TH is for a range of -55°C to $+125^\circ\text{C}$. The AD9610 is available in versions compliant with MIL-STD-883. Refer to the *Analog Devices Military Products Databook* or current AD9610/883B data sheet for detailed specifications.

AD9610—SPECIFICATIONS

DC ELECTRICAL CHARACTERISTICS ($\pm V = \pm 15V$; $A_v = -10$; $R_M = 1500\Omega$; $R_F = 15k\Omega$; No R_{LOAD})

Parameter (Conditions)	AD9610BH/TH Typical @ +25°C	AD9610BH ¹ Min/Max @			AD9610TH ² Min/Max @			Units
		-25°C	+25°C	+85°C	-55°C	+25°C	+125°C	
✓ Offset Voltage	±0.3	±4.0	±1.0	±2.5	±4.0	±1.0	±2.5	mV
✓ Offset Voltage T_C^3	±5				±25		±25	$\mu V/^\circ C$
✓ Input Bias Current								
Inverting	±5	±56	±15	±35	±56	±15	±35	μA
Noninverting	±15	±75	±50	±62	±75	±50	±62	μA
✓ Input Bias Current T_C^3								
Inverting	±70				±330		±330	nA/°C
Noninverting	±30				±200		±200	nA/°C
# Noninverting Impedance	200k							Ω
Capacitance	2							pF
# Common-Mode Input								
Internal Feedback Resistor (R_F)	±5	±5	±5	±5	±5	±5	±5	V
R_F Temperature Coefficient	1500		1490/ 1510			1490/ 1510		Ω
✓ Common-Mode Rejection Ratio (CMRR) ⁴	>50	±25	±25	±25	±25	±25	±25	ppm/°C
CMRR ($R_F = 1500\Omega$; $R_{IN} = 150\Omega$; $\Delta V_S = 5V$)	>60	≥35	≥35	≥35	≥35	≥35	≥35	dB
✓ Common-Mode Sensitivity (CMS) ⁵								dB
Referred to Input ($\Delta V_S = 5V$)								
- CMS	3	8	8	8	8	8	8	$\mu A/V$
+ CMS	3	8	8	8	8	8	8	$\mu A/V$
CMS VOLTAGE	62	≥50	≥50	≥50	≥50	≥50	≥50	dB
# Output Impedance (dc to 100kHz)	0.05							Ω
✓ Output Voltage Swing ($R_{LOAD} = 200\Omega$)	±10	±9	±9	±9	±9	±9	±9	V
# Output Current (Continuous)	±50	±50	±50	±50	±50	±50	±50	mA
✓ Open Loop Transimpedance Gain (200 Ω Load)	>1.5	≥0.7	≥0.9	≥0.7	≥0.7	≥0.9	≥0.7	M Ω
✓ Supply Current ⁶	21	≤27	≤25	≤27	≤27	≤25	≤27	mA
Power Consumption ⁶	630	≤810	≤750	≤810	≤810	≤750	≤810	mW
✓ Power Supply Rejection Ratio (PSRR) ⁴	>50	≥35	≥35	≥35	≥35	≥35	≥35	dB
PSRR ($R_F = 1500\Omega$; $R_{IN} = 150\Omega$; $\Delta V_S = 10V$)	>60							dB
✓ Power Supply Sensitivity (PSS) ⁷								
Referred to Input ($\Delta V_S = 10V$)								
PSS VOLTAGE	65	50	50	50	50	50	50	dB
- PSS	3	8	8	8	8	8	8	$\mu A/V$
+ PSS	3	8	8	8	8	8	8	$\mu A/V$

AC ELECTRICAL CHARACTERISTICS ($\pm V = \pm 15V$; $A_v = -10$; $R_M = 150\Omega$; $R_F = 1.5k\Omega$; $R_{LOAD} = 200\Omega$)

Parameter (Conditions)	AD9610BH/TH	AD9610BH ¹	AD9610BH ¹	AD9610BH ¹	AD9610TH ²	AD9610TH ²	AD9610TH ²	Units
Bandwidth (-3dB) ($V_{OUT} = 100mV$ p-p)								
✓ $G = -10$	>100	≥80	≥80	≥80	≥80	≥80	≥80	MHz
Amplitude of Peaking:								
DC to 60MHz	0	≤0.4	≤0.2	≤1.0	≤0.4	≤0.2	≤1.0	dB
>60MHz	0	≤0.6	≤0.3	≤1.8	≤0.6	≤0.3	≤1.8	dB
# Phase Nonlinearity (dc to 45MHz)	1							°
# Rise (Fall) Time ($V_{OUT} = 5V$ Step)	<3.5	≤4	≤4	≤4.3	≤4	≤4	≤4.3	ns
# Slew Rate ($V_{OUT} = 18V$ Step)	>3.5	≥3	≥3	≥2.4	≥3	≥3	≥2.4	kV/ μs
# Settling Time to 0.1% ($G = -10$; 5V Output Step)	18	≤29	≤25	≤29	≤29	≤25	≤29	ns
# Settling Time to 0.02% ($G = -10$; 5V Output Step)	30							ns
# Overshoot Amplitude ($V_{OUT} = 5V$ Output Step)	<4	≤14	≤8	≤18	≤14	≤8	≤18	%
# Propagation Delay	3.3	≤4.0	≤4.0	≤4.0	≤4.0	≤4.0	≤4.0	ns
✓ Total Harmonic Distortion (Freq. = 20 MHz; Output Voltage = 2V p-p)	55	50	50	50	50	50	50	dB
# Input Noise ($R_{LOAD} = 100\Omega$)								
Voltage (5MHz to 150MHz)	0.7	≤1.2	≤1.5	≤2.0	≤1.2	≤1.5	≤2.0	nV/ \sqrt{Hz}
Current (5MHz to 150MHz)	23	≤29	≤30	≤35	≤29	≤30	≤35	pA/ \sqrt{Hz}

Parameter	Sub-Group	AD9610BH/TH	AD9610BH			AD9610TH			Units
		Typical @ +25°C	-25°C	+25°C	+85°C	-55°C	+25°C	+125°C	
OTHER INFORMATION									
Case to Ambient, θ_{CA} ⁸ (Still Air; No Heat Sink)		65	*	*	*	*	*	*	°C/W
Case to Ambient, θ_{CA} ⁸ (500 LFM Air; No Heat Sink)		38	*	*	*	*	*	*	°C/W
MTBF ⁹		$\geq 1.48 \times 10^6$	*	*	*	*	*	*	hours

NOTES

✓ 100% tested (See Notes 1 and 2).

Specifications guaranteed by design; not tested.

*Specification same as AD9610BH/TH typical specification.

¹AD9610BH parameters preceded by a check (✓) are tested at +25°C ambient temperature; performance is guaranteed over the industrial temperature range (-25°C to +85°C) case temperature.

²AD9610TH parameters preceded by a check (✓) are tested at -55°C case, +25°C ambient, and +125°C case temperatures.

Mil-processed versions are available.

³Offset voltage T_C and bias current T_C are guaranteed over the respective temperature ranges.

⁴CMRR and PSRR apply only for stated conditions.

⁵CMS values can be used to determine the CMRR for specific gain settings according to the following worst case relationships:

$$\Delta V_{OUT} = [-CMS] [R_F] [\Delta V_{SUPPLY}] + [+CMS] [R_2] \left[1 + \frac{R_F}{R_1} \right] [\Delta V_{SUPPLY}] + [CMS_{VOLT}] \left[1 + \frac{R_F}{R_1} \right] [\Delta V_{SUPPLY}]$$

WHERE $\Delta V_{SUPPLY} = \Delta -V_{SUPPLY}$ AND $\Delta +V_{SUPPLY}$

$$CMRR = -20 \text{ LOG} \left[\frac{\Delta V_{OUT}}{\left(1 + \frac{R_F}{R_1} \right) \Delta V_{SUPPLY}} \right]$$

⁶Supply current and power dissipation numbers are for quiescent operation (input is grounded). Values increase with higher frequency operation.

⁷PSS values can be used to determine the PSRR for specific gain settings according to the following worst case relationships (See diagram in 5 above):

$$\Delta V_{OUT} = [-PSS] [R_F] [\Delta V_{SUPPLY}] + [+PSS] [R_2] \left[1 + \frac{R_F}{R_1} \right] [\Delta V_{SUPPLY}] + [PSS_{VOLT}] \left[1 + \frac{R_F}{R_1} \right] [\Delta V_{SUPPLY}]$$

WHERE $\Delta V_{SUPPLY} = \Delta -V_{SUPPLY}$ OR $\Delta +V_{SUPPLY}$

$$PSRR = -20 \text{ LOG} \left[\frac{\Delta V_{OUT}}{\left(1 + \frac{R_F}{R_1} \right) \Delta V_{SUPPLY}} \right]$$

⁸Recommended maximum junction temperature is +165°C. See Thermal Model.

⁹MTBF calculated using MIL-HNBK 217D; Ground Fixed; Temperature (case) = +70°C.

Specifications subject to change without notice.

ABSOLUTE MAXIMUM RATINGS

Supply Voltages ($\pm V_S$)	$\pm 18V$	Power Dissipation	See Thermal Model
Operating Temperature Range (case)		Junction Temperature	+165°C
AD9610BH	-25°C to +85°C	Storage Temperature Range	-65°C to +150°C
AD9610TH/TH/883B	-55°C to +125°C	Lead Temperature (soldering, 10 sec)	+300°C

ORDERING GUIDE

Model	Temperature Range	Package Description	Package Option*
AD9610BH	-25°C to +85°C	TO-8 Style Metal Can	H-12A
AD9610TH	-55°C to +125°C	TO-8 Style Metal Can	H-12A
AD9610TH/883B	-55°C to +125°C	TO-8 Style Metal Can	H-12A

*For outline information see Package Information section.

LIFE TEST/BURN-IN CIRCUIT

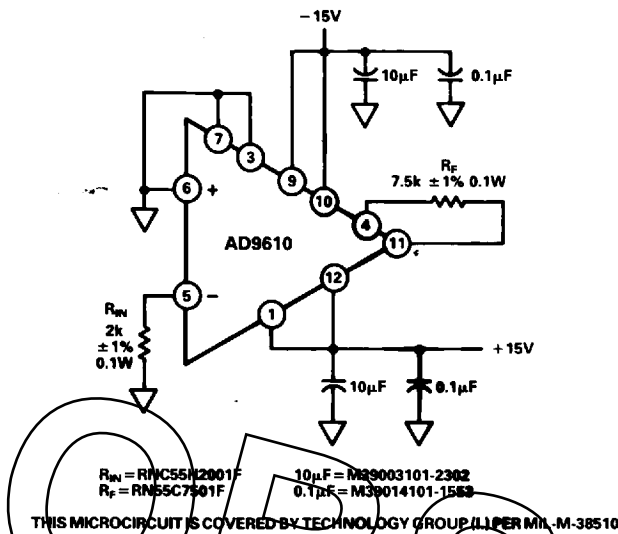

THEORY OF OPERATION

The advantages of the transimpedance AD9610 Operational Amplifier become easier to understand when its operation is compared to the operation of conventional high-speed op amps.

The operation of the AD9610 Operational Amplifier is similar to a standard voltage-input differential amplifier in terms of setting gain and calculating noise. The primary difference between the two types is a low-impedance inverting input on the AD9610; this causes the unit to use current feedback, rather than voltage feedback, to achieve signal amplification.

Figure 1 and the discussion which follows help make a comparison between the AD9610 and "conventional" devices.

Two equations are necessary to describe the amplifier shown in Figure 1.

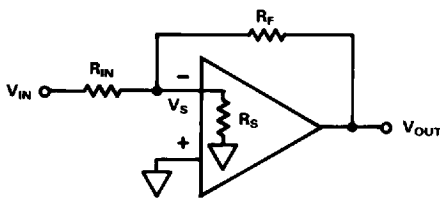

Figure 1.

One equation is a rudimentary amplifier transfer function:

$$-V_{OUT} = A(\omega) V_S \quad (\text{Equation A})$$

and the other sums the currents at the inverting input:

$$\frac{V_S - V_{IN}}{R_{IN}} + \frac{V_S}{R_S} + \frac{V_S - V_{OUT}}{R_F} = 0 \quad (\text{Equation B})$$

Rearranging and reducing Equation B; and substituting from Equation A results in a third equation:

$$\frac{V_{OUT}}{V_{IN}} = \frac{-A(\omega)R_S R_F / (R_S R_F + R_{IN} R_F + R_{IN} R_S)}{1 + A(\omega)R_{IN} R_S / (R_S R_F + R_{IN} R_F + R_{IN} R_S)} \quad (\text{Equation C})$$

For purposes of discussion, assume the amplifier shown in Figure 1 exhibits a single-pole frequency response. When it does, $A(\omega) = A_O / (1 + j\omega\tau)$ where A_O = open loop gain; and $1/\tau$ = the roll-off frequency. When these terms are substituted into Equation C, the result is:

$$\frac{V_{OUT}}{V_{IN}} = \frac{-A_O R_S R_F / (R_S R_F + R_{IN} R_F + R_{IN} R_S)}{1 + j\omega\tau + [A_O R_{IN} R_S / (R_S R_F + R_{IN} R_F + R_{IN} R_S)]}$$

Based on the idea that

$$1 + [A_O R_{IN} R_S / (R_S R_F + R_{IN} R_F + R_{IN} R_S)]$$

is approximately equal to

$$A_O R_{IN} R_S / (R_S R_F + R_{IN} R_F + R_{IN} R_S)$$

and G (closed loop gain) = R_F / R_{IN} , it becomes possible to simplify and substitute terms in the above equation to obtain:

$$\frac{V_{OUT}}{V_{IN}} = \frac{-G}{1 + \frac{j\omega\tau R_F}{A_O} \left[\frac{1}{R_{IN}} + \frac{1}{R_S} + \frac{1}{R_F} \right]}$$

The fundamental difference between the AD9610 and traditional amplifiers becomes apparent at this point.

In traditional voltage-input amplifiers, the input resistance (R_S) approaches infinity. Consequently, $1/R_S$ approaches zero; and the term $R_F (1/R_{IN} + 1/R_S + 1/R_F)$ simplifies to the term $R_F (1/R_{IN} + 1/R_F)$. The latter can be reduced further to $(G+1)$. When substitutions are made, the gain/frequency relationship for a traditional amplifier design is expressed as:

$$\frac{V_{OUT}}{V_{IN}} = \frac{-G}{1 + \frac{j\omega\tau}{A_O} [G+1]}$$

There is a dramatically different result for the AD9610.

This difference is because the value of R_S in the transimpedance amplifier is only 20Ω. This is important when one realizes $R_S \parallel R_{IN} \parallel R_F$; and $R_S \ll R_{IN}$ and/or R_F . In this case, $(1/R_S + 1/R_{IN} + 1/R_F) \approx 1/R_S$. Substituting terms, a direct comparison with traditional amplifier relationships can be made:

$$\frac{V_{OUT}}{V_{IN}} = \frac{-G}{1 + \frac{j\omega\tau}{A_O} \left[\frac{R_F}{R_S} \right]}$$

Both amplifier types yield similar algebraic results, but there is one critical difference in how they are obtained.

As shown above, the closed loop gain (G) of the traditional amplifier is multiplied by the frequency-dependent term of the denominator; this means increasing frequencies or closed loop gain accelerates the gain roll-off.

In the AD9610, however, the constant R_F/R_S is multiplied by the frequency-dependent term; this means bandwidth remains relatively constant for any given value of gain.

Inside the AD9610, the design includes a $1.5k\Omega$ feedback resistor to help reduce the effect of stray capacitances and make it easier to apply the amplifier. This internal R_F means *the gain of the AD9610 is set by varying R_{IN} .*

The differences in the architecture of the AD9610 vis-a-vis a traditional op amp cause its closed-loop frequency response to be considerably different from conventional units.

Figure 2 pictures a typical plot for a traditional single-pole amplifier.

As shown, increasing the closed loop gain of a traditional op amp decreases the bandwidth of the amplifier; the precise amount

of change will be determined by the actual roll-off characteristics of the op amp.

By contrast, the frequency response of the AD9610 changes very little when the gain is changed. Refer to Figure 3.

Variations in gain (established by varying values of R_{IN}) have only a negligible effect on the bandwidth of the amplifier.

(NOTE: For a more complete explanation of the mathematics involved in comparing conventional op amps and the AD9610, refer to the Analog Devices application note entitled "Using the AD9610 Transimpedance Amplifier.")

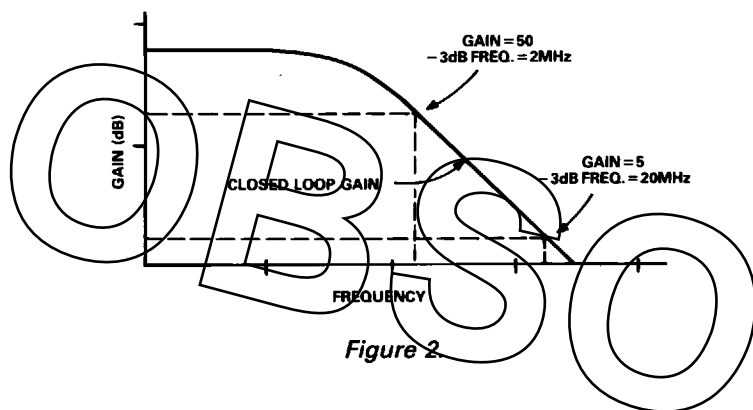

Figure 2

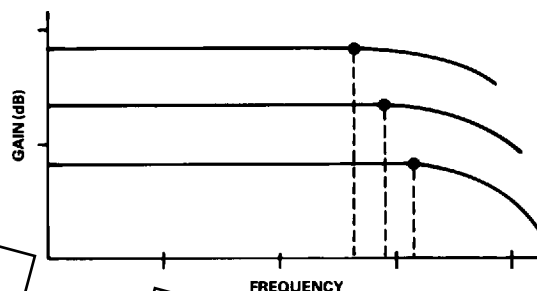

Figure 3

AD9610 FUNCTIONAL DESCRIPTION

Refer to Figure 4, AD9610 Functional Circuit.

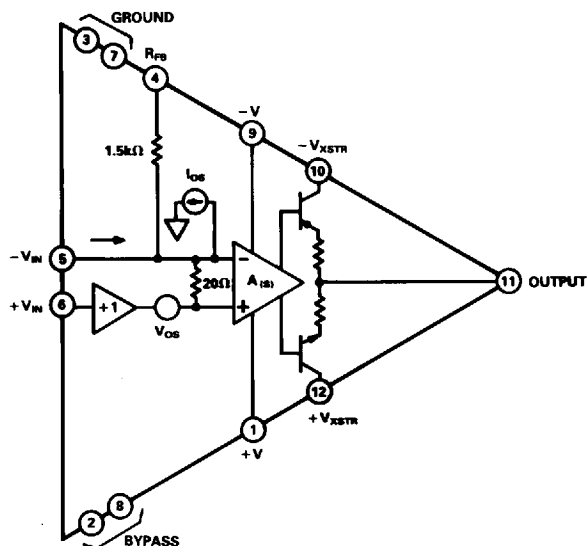

Figure 4. AD9610 Functional Circuit

The most prominent characteristic illustrated in this model of the unit is the combination of a high-impedance noninverting terminal and a low-impedance inverting terminal. This is achieved by buffering the noninverting terminal to create a high-impedance input; while maintaining a low impedance through the 20Ω characteristic of the inverting input.

Because of the low input impedance of the inverting input, all of the input signal voltage is impressed across the input resistor

(R_{IN} in Figure 6); this causes a direct voltage-to-current conversion to take place.

Conventional op amps use a volts/volts transfer function, while the transfer function of the AD9610 is volts/ μ A (or resistance).

Signal current flowing in the inverting terminal (Pin 5) will flow through the 20Ω resistor. The voltage developed across this input impedance becomes the input signal for the internal amplifier.

As a result of this action, the input current is converted to an output voltage; this is the reason for the open loop transfer function being expressed in ohms.

To compensate for variations in offset voltage and current in the AD9610, both a voltage source and a current source are included in the unit. Input offset voltage (V_{OS}) is a dc error which appears at the output as $[V_{OS} (1 + R_F/R_{IN})]$. In a similar fashion, the input bias current (I_{OS}) reflects as a dc error which appears at the output as $[I_{OS} (R_F)]$.

The current source connected to the inverting terminal effectively models the input offset current; and although bias currents flow in both terminals, the inverting input bias current is dominant. The combined actions of the internal voltage and current sources effectively compensate for discrepancies in offset voltage and current.

Power supply voltages applied to the AD9610 are separated, with one set of terminals designated for the output transistors (Pins 10 and 12) and another set for the internal amplifier (Pins 1 and 9). This splitting of the voltages makes it possible to limit voltage swings and current at the output, and helps regulate the junction temperatures of the output transistors.

AD9610

APPLYING THE AD9610 OP AMP

In applying the AD9610 op amp, there are certain precautions which **must** be observed to protect the unit from damage:

1. Shorting either power supply input pin (Pin 10 or Pin 12) to the output (Pin 11) will destroy the device.
2. Shorting the output (Pin 11) to ground will destroy the device; no internal protection is provided.

As explained earlier, the noninverting input of the AD9610 Operational Amplifier is a high impedance. This requires that it be driven from a low-impedance source, or connected to ground. Driving this input from a high impedance detracts from the wide bandwidth performance; connecting it to ground avoids the possibility of closed-loop ac peaking.

Because the internal biasing network of the AD9610 is connected to the +V and -V supply pins, it is important that these pins have adequate decoupling. Nominal supply voltages for the AD9610 are $\pm 15V$, but this can be reduced to a lower limit of $\pm 12V$ without serious degradation of high-speed performance. When $\pm 12V$ supplies are used, output voltage swings from the amplifier must be reduced.

Bypass Pins 2 and 8 should be decoupled to ground through 33 - 50 Ω resistors and 0.1 μF capacitors to maintain stability on the bias network.

Feedback resistor R_F is internal to the AD9610 and has been precisely adjusted to allow the widest possible range of operating conditions. While it is possible to use an external feedback resistor for the device, the user is urged to avoid the temptation to "tune" performance with this technique because it will inevitably detract from ac performance.

A massive low-impedance ground plane is essential for optimum performance from the AD9610 because it provides a moderate level of shielding and helps reduce the effects of distributed capacitance.

But the benefits of a large ground plane can be diminished if components are grounded at multiple points on the ground plane. Single-point grounding is *always* preferred for high-speed circuits to avoid the possibility of voltage differentials which might result from multiple grounds.

The best high-frequency performance is obtained from the AD9610 when total output capacitance is minimized. Realistically, this is not always possible; but performance can be improved with a 5 - 30 Ω resistor in series with the output as shown in Figure 5.

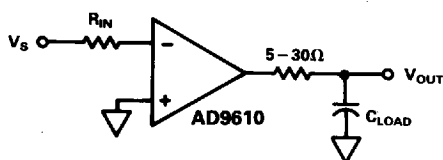

Figure 5.

Isolation provided by the series resistor makes it possible for the AD9610 to drive loads well outside its design limits, but at some loss of speed. Isolating the capacitive load from the output of the amplifier is particularly useful when driving flash A/D converters.

The power supplies for the AD9610 must be decoupled effectively to obtain maximum performance from the device. Recommended choices are a 0.1 μF ceramic capacitor and a 10 μF tantalum capacitor in parallel on each supply. These connections show up in Figures 6 and 7 which illustrate the connections for inverting and noninverting operation, respectively. Decoupling components should always be connected as closely as possible to the amplifier's voltage supply pins.

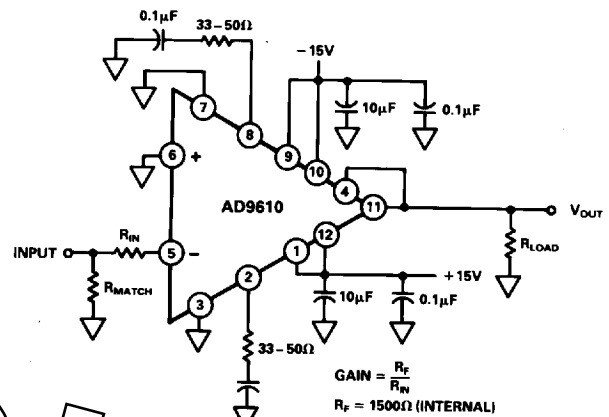

Figure 6. AD9610 Inverting Operation

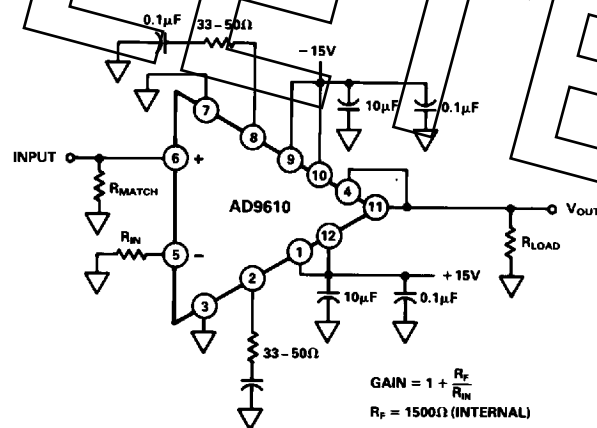

Figure 7. AD9610 Noninverting Operation

If the expected output voltage swings are small, it is possible to operate the output stages from $\pm 5V$ supplies; this will reduce power dissipation and junction temperatures on the output transistors. For this, the $\pm 5V$ and $\pm 15V$ supplies must be decoupled separately.

As shown in Figures 6 and 7, bypass Pins 2 and 8 should be decoupled individually with a 33 - 50 Ω resistor and 0.1 μF capacitor in series to ground. Without this decoupling, power supply and common-mode rejection ratios (PSRR and CMRR) may be degraded. In some applications, the lack of this decoupling may show up as very high-frequency "ringing" on the output. R_{MATCH} in Figures 6 and 7 is used to match the output impedance of the driving source.

AD9610 POWER DISSIPATION

Quiescent power supply currents for the AD9610 are $\pm 21\text{mA}$. Supply currents this low allow the unit to be operated over a wide temperature range without damage. For high-temperature operation and long-term stability, however, the user is urged to use a heat sink. Two acceptable models for TO-8 packages are the Thermalloy 2240 and the IERC Up-TO8-48CB.

Refer to Figure 8.

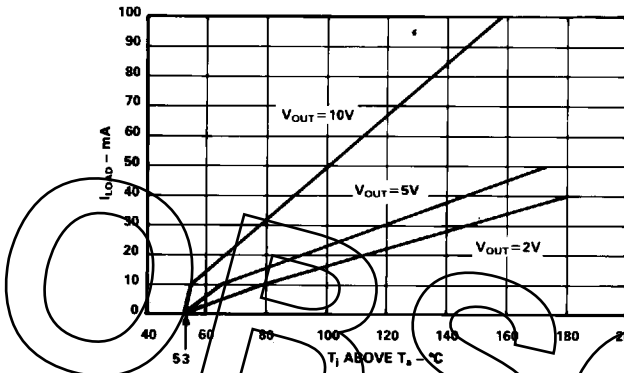
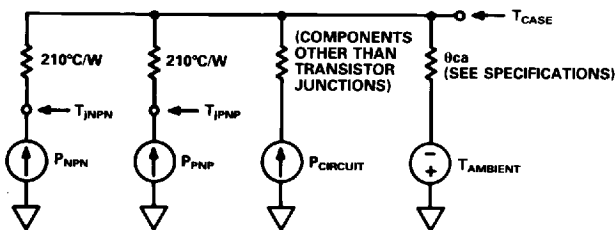

Figure 8. Junction Temp Rise vs. Load Current

The data in this illustration are typical characteristics when the AD9610 is operated from $\pm 15\text{V}$ supplies. Assume the desired output from the op amp is $\pm 10\text{V}$ swings at $\pm 50\text{mA}$ currents. For this combination, maximum junction temperature will be 100°C above the ambient temperature.

Since maximum allowable junction temperature is $+165^\circ\text{C}$, the maximum ambient temperature which can be tolerated is $+65^\circ\text{C}$. If there is a possibility the ambient may exceed this limit, heat sinking and/or heat removal is required. Additional details on the thermal characteristics of the unit are included in the AD9610 Thermal Model. (For more information on thermal protection, consult the Analog Devices application note "Using the AD9610 Transimpedance Amplifier".)



$$P_{\text{CIRCUIT}} = I_{\text{CC}} [+V_{\text{CC}} - (-V_{\text{CC}})] \text{ WHERE } I_{\text{CC}} = 21\text{mA (at } \pm 15\text{V)}$$

$$P_{\text{XXX}} = [(\pm V_{\text{CC}}) - V_{\text{OUT}} - I_{\text{COL}}(\theta)] (I_{\text{COL}}) (\% \text{ DUTY CYCLE})$$

NOTE: xxx = NPN OR PNP

(FOR POSITIVE V_{OUT} AND V_{CC} , THIS IS POWER IN NPN OUTPUT STAGE; FOR NEGATIVE V_{OUT} AND V_{CC} , THIS IS POWER IN PNP OUTPUT STAGE. $I_{\text{COL}} = V_{\text{OUT}}/R_{\text{LOAD}}$ OF 3.0mA , WHICHEVER IS GREATER. FEEDBACK RESISTOR R_F IS INCLUDED IN R_{LOAD} .)

$$T_{\text{J(NPN)}} = P_{\text{PNP}} (210 + \theta_{\text{ca}}) + (P_{\text{CIRCUIT}} + P_{\text{NPN}}) (\theta_{\text{ca}}) + T_{\text{a}}. \text{ SIMILAR FOR } T_{\text{J(PNP)}}$$

AD9610 Thermal Model

AD9610 PERFORMANCE

In the following section, graphs and photographs depict typical performance of the AD9610 for various characteristics.

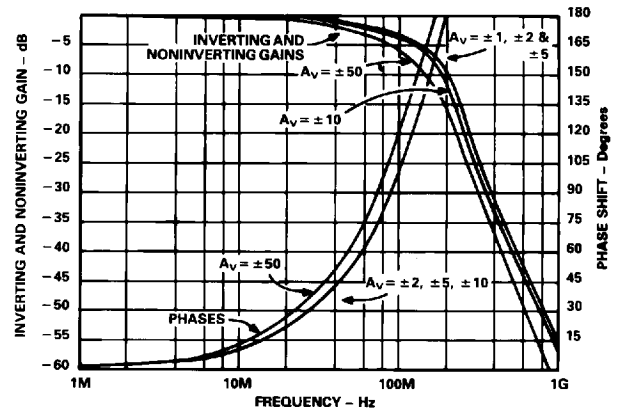

AD9610 Frequency Response ($A_V = \pm 1, \pm 2, \pm 5, \pm 10, \pm 50$)

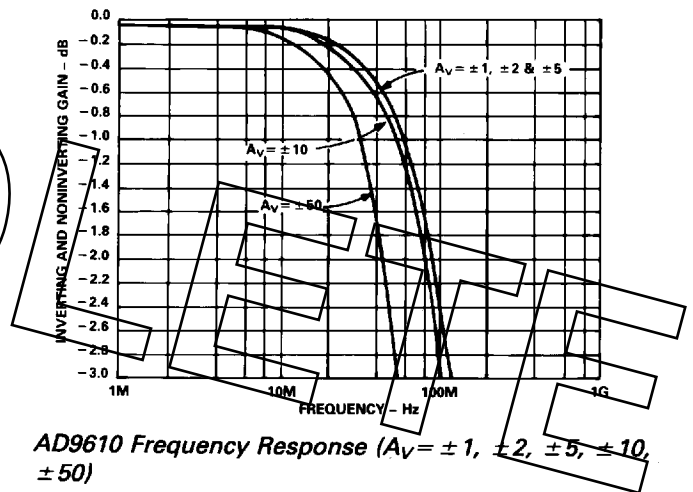

AD9610 Frequency Response ($A_V = \pm 1, \pm 2, \pm 5, \pm 10, \pm 50$)

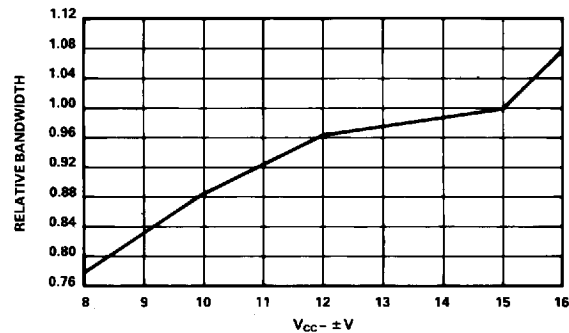

Bandwidth vs. V_{CC}

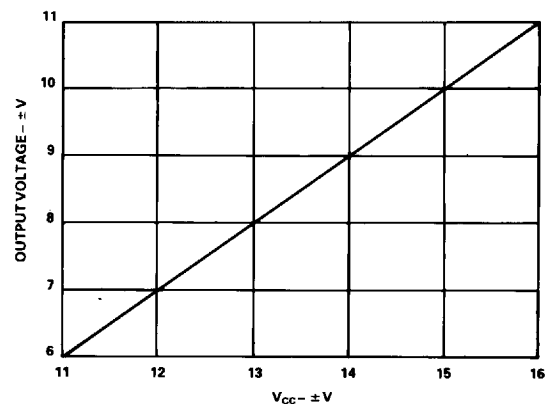

Output Voltage vs. V_{CC}

AD9610

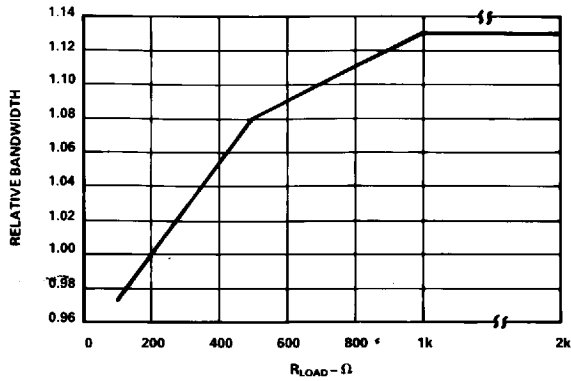

Bandwidth vs. Load

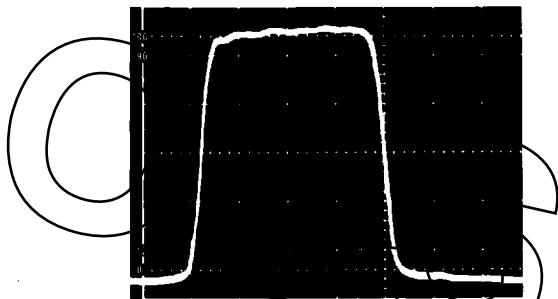

GAIN = -10; 136mV/DIV; 10ns/DIV

AD9610 Small-Signal Pulse Response



GAIN = -10; 3.4V/DIV; 10ns/DIV

AD9610 Large-Signal Pulse Response

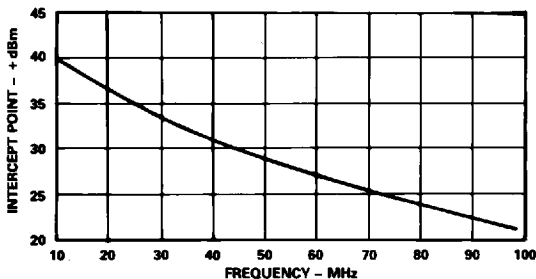

Two-Tone, 3rd Order IMD Intercept ($G = -5$; $R_L = 50\Omega$)

Information in graphs above can be used to obtain effective output impedance versus frequency.

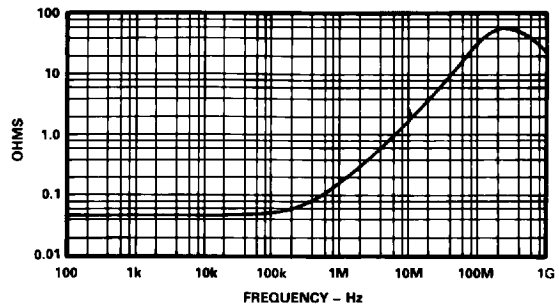

Small-Signal Output Resistance vs. Frequency ($G = -10$)

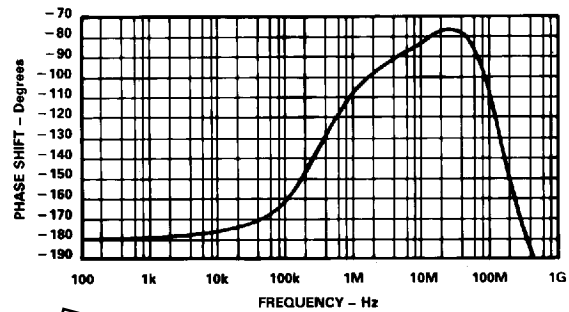

Small-Signal Output Phase Shift vs. Frequency ($G = -10$)

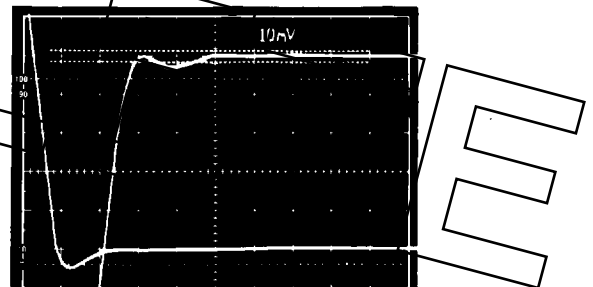

GAIN = -10; 5V OUTPUT; ERROR WINDOW ($\pm 5mV$) = 0.1%; 5ns/DIV

AD9610 Settling Time

ORDERING INFORMATION

The AD9610BH is specified for operation over a case temperature range of -25°C to $+85^{\circ}\text{C}$; the AD9610TH is intended for applications in which case temperature may be between -55°C and $+125^{\circ}\text{C}$. The AD9610TH/883B is processed per MIL-STD-883B.