

Am29C841/Am29C843 Am29C941/Am29C943

High-Performance CMOS Bus Interface Latches

Am29C841/Am29C843
Am29C941/Am29C943

DISTINCTIVE CHARACTERISTICS

- High-speed parallel latches
 - D-Y propagation delay = 7 ns typical
- Low standby power
- I_{OL} = 24 mA, Commercial and Military
- JEDEC FCT-compatible specs
- Extra-wide (9- and 10-bit) data paths
- Am29C900 DIP pinout option reduces lead inductance on V_{CC} and GND pins

GENERAL DESCRIPTION

The Am29C841 and Am29C843 CMOS Bus Interface Latches are designed to eliminate the extra devices required to buffer stand alone latches and to provide extra data width for wider address/data paths or buses carrying parity. The Am29C800 latches are produced with AMD's exclusive CS-11 CMOS process, and feature typical propagation delays of 7 ns, as well as an output current drive of 24 mA.

The Am29C841 is a buffered, 10-bit version of the popular '373 function. The Am29C843 is a 9-bit buffered latch with

Preset (\overline{PRE}) and Clear (\overline{CLR}) — ideal for parity bus interfacing in high-performance microprogrammed systems.

The Am29C841 and Am29C843 are available in the standard package options: DIPs, PLCCs, LCCs, SOICs, and Flatpacks. In addition, a DIP pinout option, featuring center V_{CC} and GND pins, reduces the lead inductance of the V_{CC} and GND pins. The ordering part numbers for CMOS latches with this pinout are the Am29C941 and Am29C943; their pinouts are shown later in this data sheet.

BLOCK DIAGRAMS

Am29C841

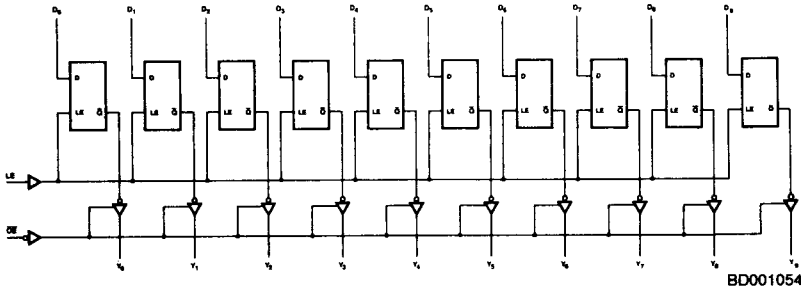

Am29C843

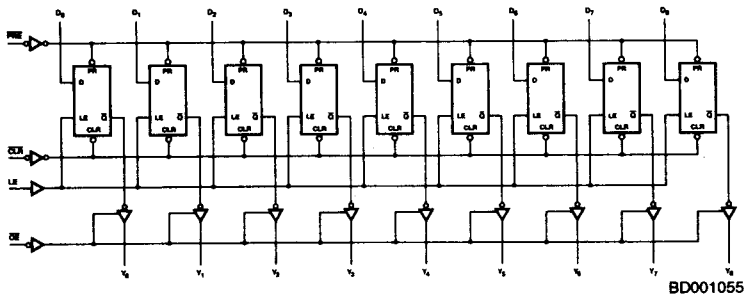

CONNECTION DIAGRAMS
Top View

Am29C841

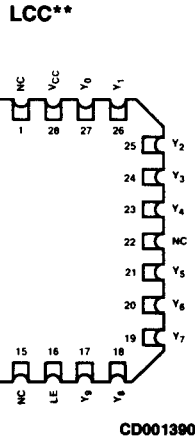
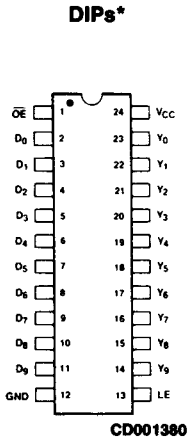

Am29C941

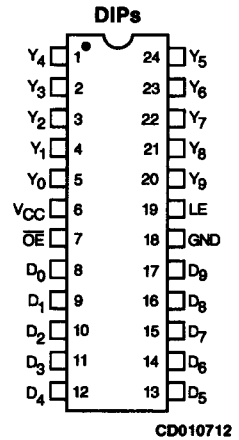

Am29C843

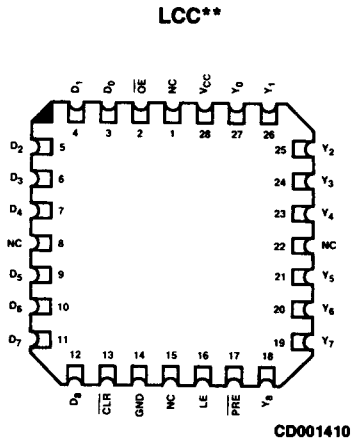
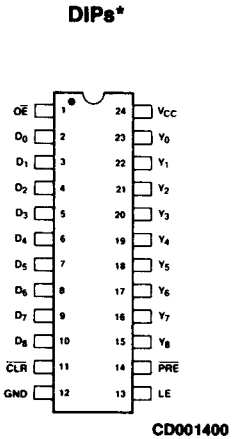

Am29C943

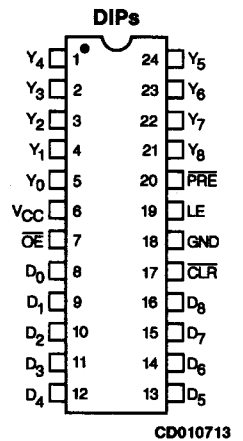

*Also available in 24-Pin Flatpack and Small Outline package; pinout identical to DIPs.

**Also available in 28-Pin PLCC; pinout identical to LCC.

LOGIC SYMBOLS

Am29C841

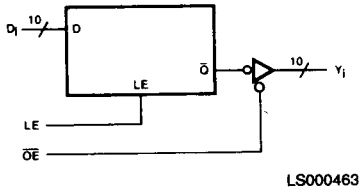

Am29C843

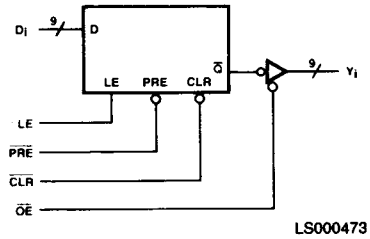

FUNCTION TABLES

Am29C841

Inputs			Internal	Outputs	Function
OE	LE	D1	Q1	Y1	
H	X	X	X	Z	Hi-Z
H	H	L	H	Z	Hi-Z
H	H	H	L	Z	Hi-Z
H	L	X	NC	Z	Latched (Hi-Z)
L	H	L	H	L	Transparent
L	H	H	L	H	Transparent
L	L	X	NC	NC	Latched

Am29C843

Inputs					Internal	Outputs	Function
CLR	PRE	OE	LE	D1	Q1	Y1	
H	H	H	X	X	X	Z	Hi-Z
H	H	H	H	H	L	Z	Hi-Z
H	H	H	H	L	H	Z	Hi-Z
H	H	H	L	X	NC	Z	Latched (Hi-Z)
H	H	L	H	H	L	H	Transparent
H	H	L	H	L	H	L	Transparent
H	H	L	L	X	NC	NC	Latched
H	L	L	X	X	L	H	Preset
L	H	L	X	X	H	L	Clear
L	L	L	X	X	H	H	Preset
L	H	H	L	X	L	Z	Latched (Hi-Z)
H	L	H	L	X	L	Z	Latched (Hi-Z)

H = HIGH
 L = LOW
 X = Don't Care
 NC = No Change
 Z = High Impedance

Am29C841/Am29C843
Am29C941/Am29C943

ORDERING INFORMATION
Standard Products

AMD products are available in several packages and operating ranges. The order number (Valid Combination) is formed by a combination of:

- a. Device Number
- b. Speed Option (if applicable)
- c. Package Type
- d. Temperature Range
- e. Optional Processing

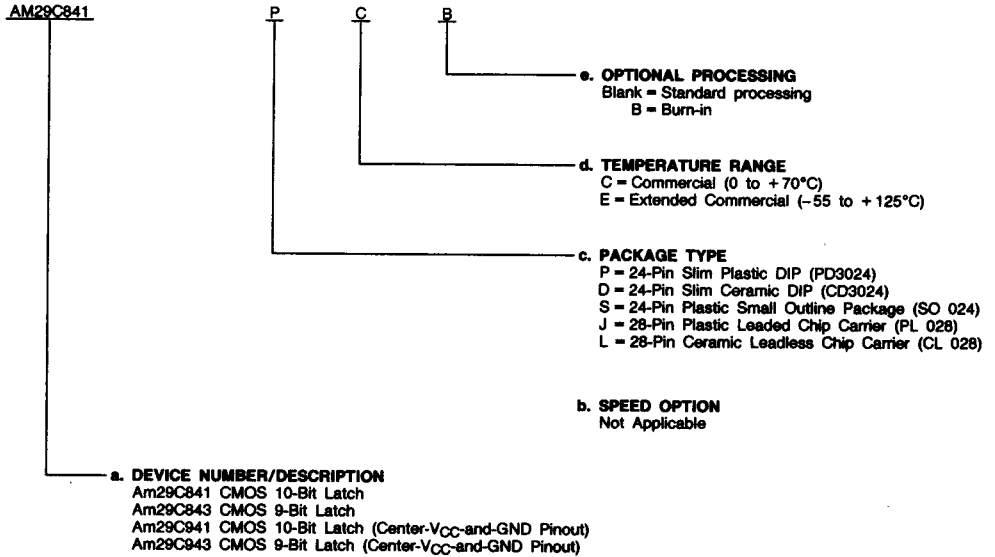

Valid Combinations	
AM29C841	PC, PCB, DC, DCB, DE, SC, JC, LC
AM29C843	PC, PCB, DC, DCB, DE
AM29C941	PC, PCB, DC, DCB, DE
AM29C943	PC, PCB, DC, DCB, DE

Valid Combinations

Valid Combinations list configurations planned to be supported in volume for this device. Consult the local AMD sales office to confirm availability of specific valid combinations, to check on newly released valid combinations, and to obtain additional data on AMD's standard military grade products.

ORDERING INFORMATION (Cont'd.)

APL Products

AMD products for Aerospace and Defense applications are available in several packages and operating ranges. APL (Approved Products List) products are fully compliant with MIL-STD-883C requirements. The order number (Valid Combination) for APL products is formed by a combination of:

- a. Device Number
- b. Speed Option (if applicable)
- c. Device Class
- d. Package Type
- e. Lead Finish

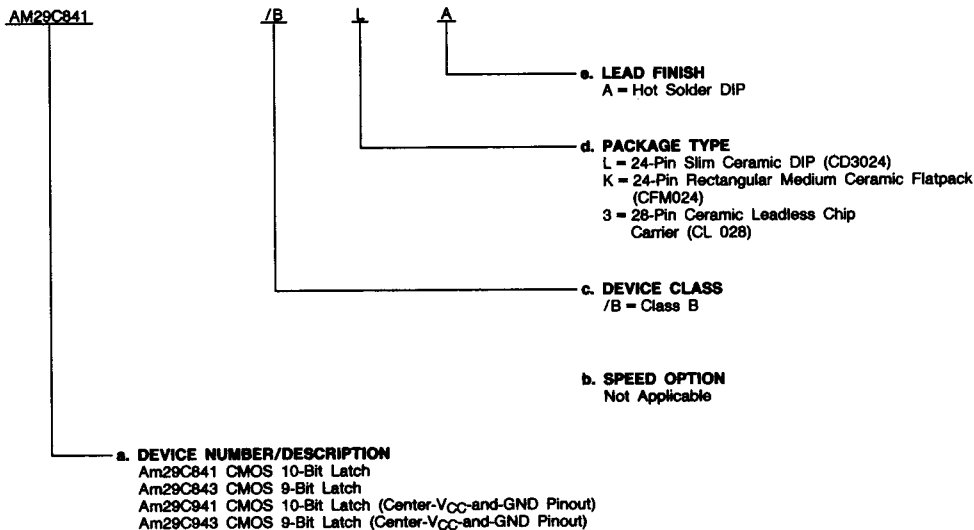

Valid Combinations	
AM29C841	/BLA, /BKA, /B3A
AM29C843	
AM29C841	/BLA
AM29C843	

Valid Combinations

Valid Combinations list configurations planned to be supported in volume for this device. Consult the local AMD sales office to confirm availability of specific valid combinations or to check for newly released valid combinations.

Group A Tests

Group A tests consist of Subgroups 1, 2, 3, 7, 8, 9, 10, 11.

PIN DESCRIPTION

Am29C841/Am29C843

D_i Data Inputs (Input)

D_i are the latch data inputs.

Y_i Data Outputs (Output)

Y_i are the three state data outputs.

LE Latch Enable (Input, Active HIGH)

The latches are transparent when LE is HIGH. Input data is latched on a HIGH-to-LOW transition.

\overline{OE} Output Enable (Input, Active LOW)

When \overline{OE} is LOW, the latch data is passed to the Y_i outputs. When \overline{OE} is HIGH, the Y_i outputs are in the high impedance state.

Am29C843 Only

\overline{PRE} Preset (Input, Active LOW)

When \overline{PRE} is LOW, the outputs are HIGH if \overline{OE} is LOW. \overline{PRE} overrides the \overline{CLR} pin. \overline{PRE} will set the latch independent of the state of \overline{OE} .

\overline{CLR} Clear (Input, Active LOW)

When \overline{CLR} is LOW, the internal latch is cleared. When \overline{CLR} is LOW, the outputs are LOW if \overline{OE} is LOW and \overline{PRE} is HIGH. When \overline{CLR} is HIGH, data can be entered into the latch.

ABSOLUTE MAXIMUM RATINGS

Storage Temperature	-65 to +150°C
Supply Voltage to Ground Potential	
Continuous	-0.5 V to +7.0 V
DC Output Voltage	-0.5 V to $V_{CC} + 0.5$ V
DC Input Voltage	-0.5 V to $+V_{CC} + 0.5$ V
DC Output Diode Current: Into Output	+50 mA
Out of Output	-50 mA
DC Input Diode Current: Into Input	+20 mA
Out of Input	-20 mA
DC Output Current per Pin: I_{SINK}	+48 mA ($2 \times I_{OL}$)
I_{SOURCE}	-30 mA ($2 \times I_{OH}$)
Total DC Ground Current ($n \times I_{OL} + m \times I_{CCT}$) mA (Note 1)	
Total DC V_{CC} Current ($n \times I_{OH} + m \times I_{CCT}$) mA (Note 1)	

Stresses above those listed under ABSOLUTE MAXIMUM RATINGS may cause permanent device failure. Functionality at or above these limits is not implied. Exposure to absolute maximum ratings for extended periods may affect device reliability.

OPERATING RANGES

Commercial (C) Devices	
Temperature (T_A)	0 to +70°C
Supply Voltage (V_{CC})	+4.5 V to +5.5 V
Military (M) and Extended Commercial (E) Devices	
Temperature (T_A)	-55 to +125°C
Supply Voltage (V_{CC})	+4.5 V to +5.5 V

Operating ranges define those limits between which the functionality of the device is guaranteed.





DC CHARACTERISTICS over operating range unless otherwise specified (for APL Products, Group A, Subgroups 1, 2, 3 are tested unless otherwise noted)

Parameter Symbol	Parameter Description	Test Conditions		Min.	Max.	Units
V_{OH}	Output HIGH Voltage	$V_{CC} = 4.5$ V $V_{IN} = V_{IH}$ or V_{IL}	$I_{OH} = -15$ mA	2.4		Volts
V_{OL}	Output LOW Voltage	$V_{CC} = 4.5$ V $V_{IN} = V_{IH}$ or V_{IL}	$I_{OL} = 24$ mA		0.5	Volts
V_{IH}	Input HIGH Voltage	Guaranteed Input Logical HIGH Voltage for All Inputs (Note 2)		2.0		Volts
V_{IL}	Input LOW Voltage	Guaranteed Input Logical LOW Voltage for All Inputs (Note 2)			0.8	Volts
V_I	Input Clamp Voltage	$V_{CC} = 4.5$ V, $I_{IN} = -18$ mA			-1.2	Volts
I_{IL}	Input LOW Current	$V_{CC} = 5.5$ V, $V_{IN} = GND$			-10	μ A
		$V_{CC} = 5.5$ V, $V_{IN} = 0.4$ V			-5	
I_{IH}	Input HIGH Current	$V_{CC} = 5.5$ V, $V_{IN} = 2.7$ V			5	μ A
		$V_{CC} = 5.5$ V, $V_{IN} = 5.5$ V			10	
I_{OZH}	Output Off-State Current (High Impedance)	$V_{CC} = 5.5$ V, $V_O = 5.5$ V or 2.7 V (Note 3)			+10	μ A
I_{OZL}		$V_{CC} = 5.5$ V, $V_O = 0.4$ V or GND (Note 3)			-10	μ A
I_{SC}	Output Short-Circuit Current	$V_{CC} = 5.5$ V, $V_O = 0$ V (Note 4)		-60		mA
I_{CCO}	Static Supply Current	$V_{CC} = 5.5$ V Outputs Open	$V_{IN} = V_{CC}$ or GND	MIL	160	μ A
				COM'L	120	
I_{CCT}			$V_{IN} = 3.4$ V	Data Input	1.5	mA/Bit
				OE, PRE, CLR, LE	3.0	
I_{CCD}^\dagger	Dynamic Supply Current	$V_{CC} = 5.5$ V (Note 5)			275	μ A/MHz/Bit

- Notes:**
1. n = number of outputs, m = number of inputs.
 2. Input thresholds are tested in combination with other DC parameters or by correlation.
 3. Off-state currents are only tested at worst-case conditions of $V_{OUT} = 5.5$ V or 0.0 V.
 4. Not more than one output shorted at a time. Duration should not exceed 100 milliseconds.
 5. Measured at a frequency ≤ 10 MHz with 50% duty cycle.

† Not included in Group A tests.

SWITCHING CHARACTERISTICS over operating range unless otherwise specified (for APL Products, Group A, Subgroups 9, 10, 11 are tested unless otherwise noted)

Parameter Symbol	Parameter Description	Test Conditions*	COMMERCIAL		MILITARY		Units
			Min.	Max.	Min.	Max.	
t _{PLH}	Data (D _i) to Output Y _i (LE = HIGH)	C _L = 50 pF R ₁ = 500 Ω R ₂ = 500 Ω		11		14	ns
t _{PHL}				11		14	ns
t _S	Data to LE Setup Time		3		3		ns
t _H	Data to LE Hold Time		4		4		ns
t _{PLH}	Latch Enable (LE) to Y _i			12		14	ns
t _{PHL}				12		14	ns
t _{PLH}	Propagation Delay, Preset to Y _i			13		15	ns
t _{PHL}				13		15	ns
t _{REC}	Preset (PRE ) to LE Setup Time		4		4		ns
t _{PLH}	Propagation Delay, Clear to Y _i			12		14	ns
t _{PHL}				12		14	ns
t _{REC}	Clear (CLR ) to LE Setup Time		3		3		ns
t _{PWH}	LE Pulse Width				9		ns
t _{PWL}	Preset Pulse Width				12		ns
t _{PWL}	Clear Pulse Width				12		ns
t _{ZH}	Output Enable Time \overline{OE}  to Y _i			12		14	ns
t _{ZL}					12		14
t _{HZ}	Output Disable Time \overline{OE}  to Y _i			12		14	ns
t _{LZ}					12		14

*See Test Circuit and Waveforms.

PACKAGE OUTLINES*

T-90-20

PD3024

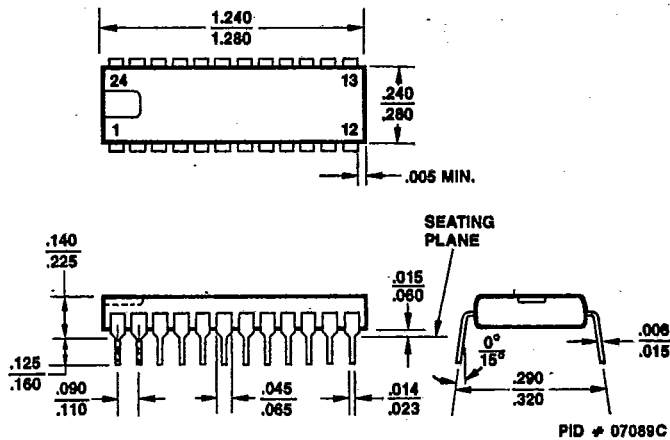

CD3024

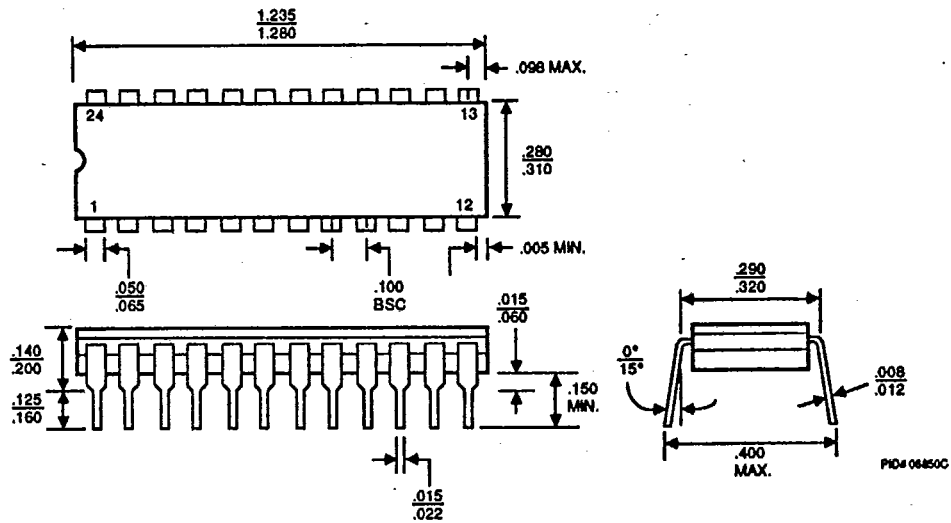

*For reference only.

PACKAGE OUTLINES (Cont'd.)

T-90-20

SO 024

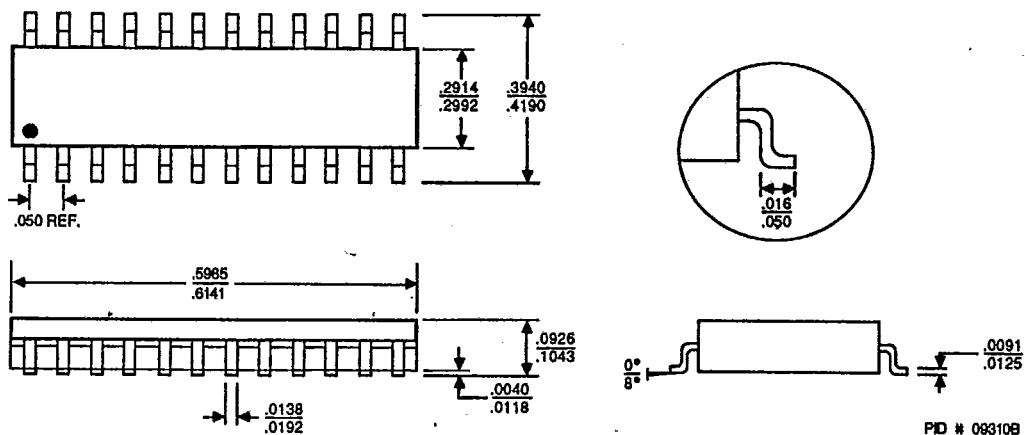

CFM024

