

National Semiconductor is now part of
Texas Instruments.

Search <http://www.ti.com/> for the latest technical
information and details on our current products and services.

Audio Sub-System with Stereo DAC, Mono Class AB Loudspeaker Amplifier, OCL/SE Stereo Headphone Output and RF Suppression

General Description

The LM49321 is an integrated audio sub-system designed for mono voice, stereo music cell phones connecting to base band processors with mono differential analog voice paths. Operating on a 3.3V supply, it combines a mono speaker amplifier delivering 520mW into an 8Ω load, a stereo headphone amplifier delivering 36mW per channel into a 32Ω load, and a mono earpiece amplifier delivering 55mW into a 32Ω load. The headphone amplifier can be configured for output capacitor-less (OCL) or single-ended (SE) mode. It integrates the audio amplifiers, volume control, mixer, and power management control all into a single package. In addition, the LM49321 routes and mixes the single-ended stereo and differential mono inputs into multiple distinct output modes. The LM49321 features an I²S serial interface for full range audio and an I²C or SPI compatible interface for control. The full range music path features an SNR of 85dB with up to 192kHz playback.

Boomer audio power amplifiers are designed specifically to provide high quality output power with a minimal amount of external components.

Key Specifications

■ P _{OUT} LS, 8Ω, 3.3V, 1% THD+N	520mW (typ)
■ P _{OUT} HP, 32Ω, 3.3V, 1% THD+N	36mW (typ)
■ P _{OUT} Mono Earpiece, 32Ω 1% THD+N	55mW (typ)
■ Shutdown current	0.6μA (typ)
■ SNR (DAC + Amplifier)	85dB (typ)

Features

- 18-bit stereo DAC with up to 192kHz sampling rate
- Multiple distinct output modes
- Mono class AB speaker amplifier
- Stereo OCL/SE headphone amplifier
- Mono earpiece amplifier
- Differential mono analog input
- Single-ended analog inputs
- Independent loudspeaker, headphone and mono earpiece volume controls
- I²C/SPI (selectable) compatible interface
- Ultra low shutdown current
- Click and Pop Suppression circuit

Applications

- Cell Phones
- PDAs
- Laptop computers
- Portable devices

Block Diagram

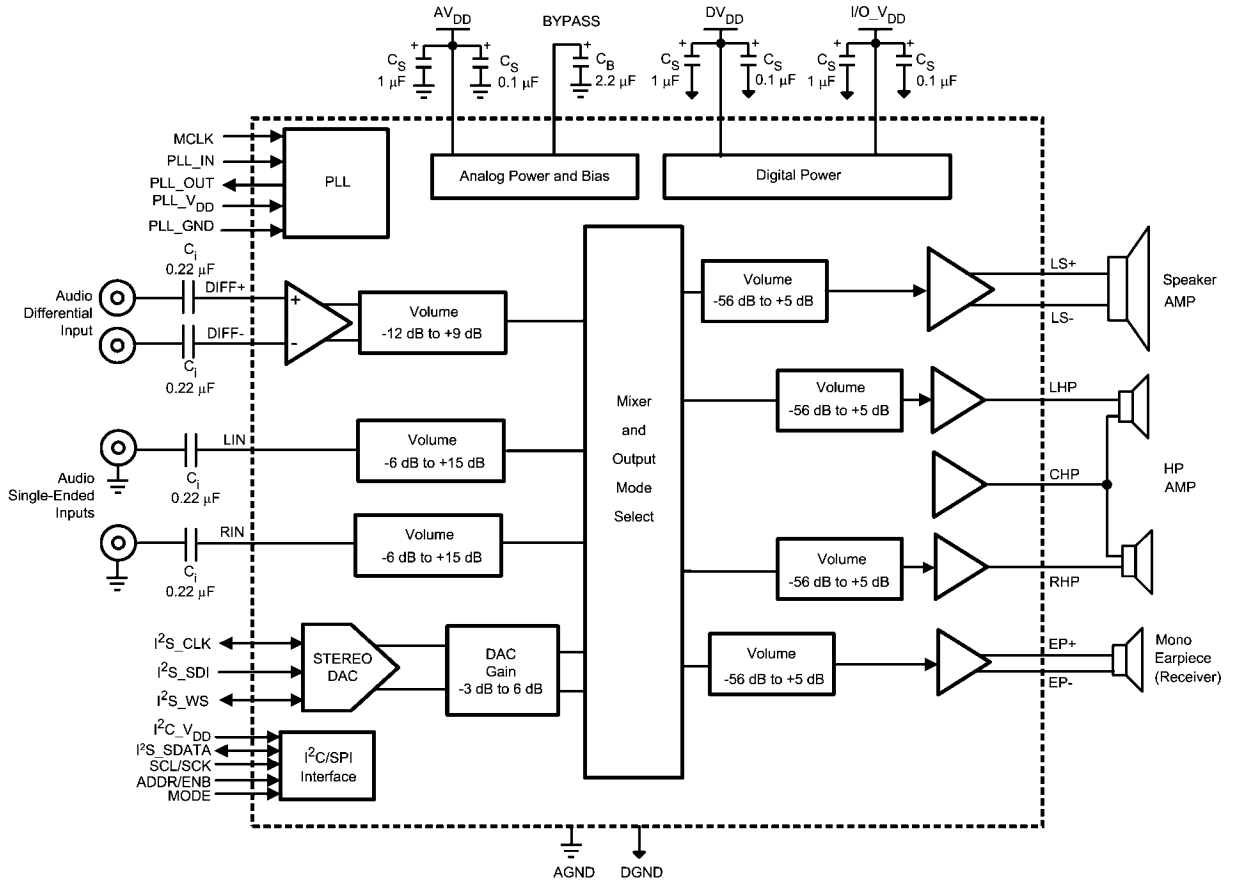

FIGURE 1A: Typical Audio Amplifier Subsystem Application circuit with Output Capacitor-less (OCL) Headphone configuration 30061832

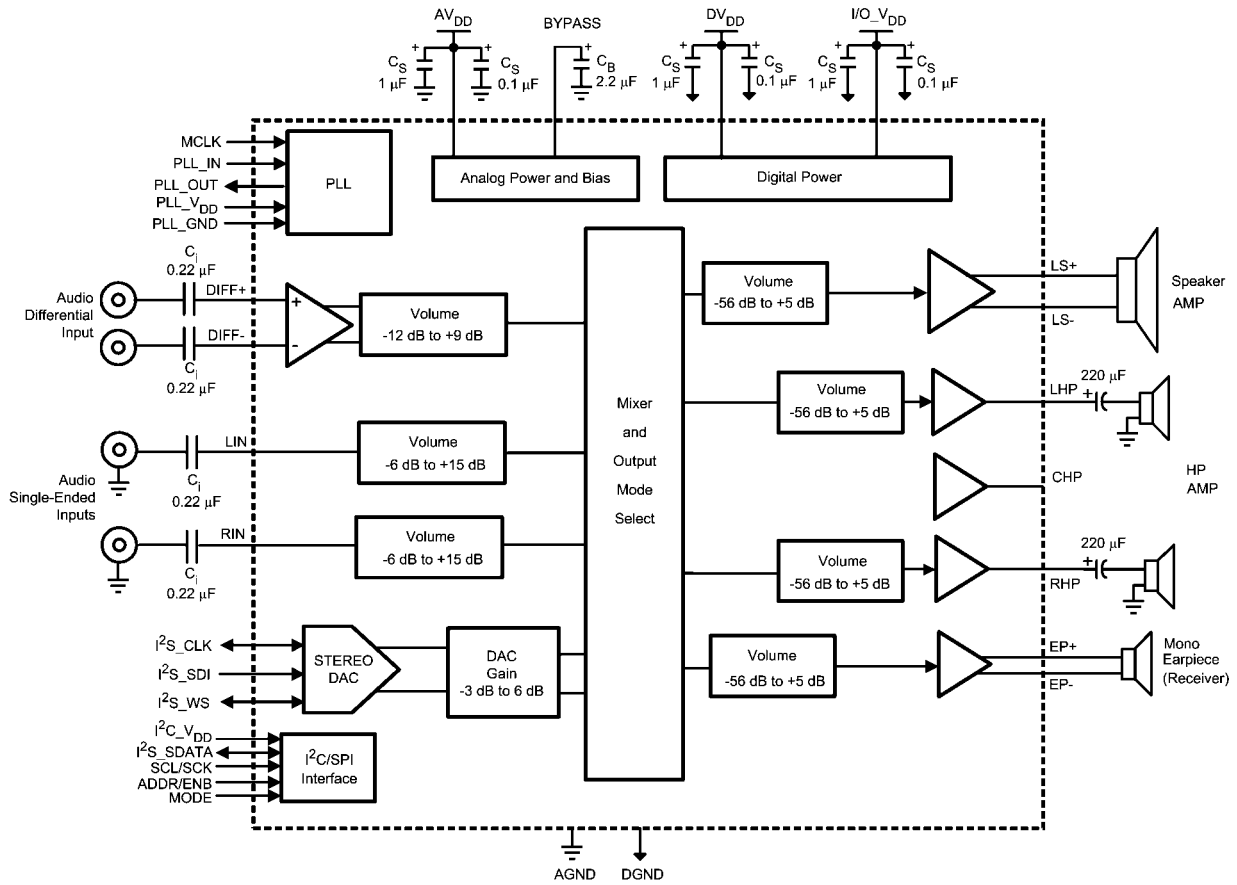
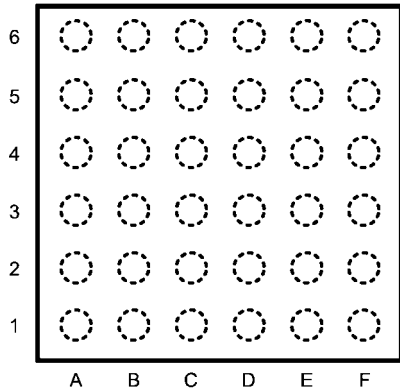

FIGURE 1B: Typical Audio Amplifier Subsystem Application circuit with Cap-Coupled single-ended (SE) Headphone configuration

30061833

Connection Diagrams

36 – Bump Micro SMD



30061858

Top View (Bump Side Down)
Order Number LM49321RL
See NS Package Number RLA36LVA

36 – Bump Micro SMD
Top Marking Drawing

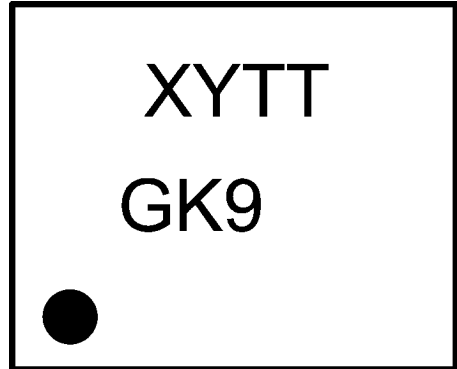

30061802

Top View
XY — 2 Digit Date Code
TT — Die Traceability
G — Boomer Family
K9 — LM49321RL

Pin Descriptions

Pin	Pin Name	Digital/ Analog	I/O, Power	Description
A1	DGND	D	P	DIGITAL GND
A2	MCLK	D	I	MASTER CLOCK
A3	I ² S_WS	D	I/O	I ² S WORD SELECT
A4	SDA/SDI	D	I/O	I ² C SDA OR SPI SDI
A5	DV _{DD}	D	P	DIGITAL SUPPLY VOLTAGE
A6	I/O_V _{DD}	D	P	I/O SUPPLY VOLTAGE
B1	PLL_VDD	D	P	PLL SUPPLY VOLTAGE
B2	I ² S_SDATA	D	I	I ² S SERIAL DATA INPUT
B3	I ² S_CLK	D	I/O	I ² S CLOCK SIGNAL
B4	GPIO	D	O	TEST PIN (MUST BE LEFT FLOATING)
B5	I ² C_V _{DD}	D	P	I ² C SUPPLY VOLTAGE
B6	SDL/SCK	D	I	I ² C_SCL OR SPI_SCK
C1	PLL_GND	D	P	PHASE LOCK LOOP GROUND
C2	PLL_OUT	D	O	PHASE LOCK LOOP FILTER OUTPUT
C3	PLL_IN	D	I	PLL FILTER INPUT
C4	ADDR/ENB	D	I	I ² C ADDRESS OR SPI ENB DEPENDING ON MODE
C5	BYPASS	A	I	HALF-SUPPLY BYPASS
C6	AV _{DD}	A	P	ANALOG SUPPLY VOLTAGE
D1	AGND	A	P	ANALOG GROUND
D2	AGND	A	P	ANALOG GROUND
D3	NC			NO CONNECT (MUST BE LEFT FLOATING)
D4	MODE	D	I	SELECTS BETWEEN I ² C OR SPI CONTROL
D5	RHP	A	O	RIGHT HEADPHONE OUTPUT
D6	CHP	A	O	HEADPHONE CENTER PIN OUTPUT (1/2 VDD or GND)
E1	DIFF-	A	I	ANALOG NEGATIVE DIFFERENTIAL INPUT
E2	LIN	A	I	ANALOG LEFT CHANNEL INPUT
E3	RIN	A	I	ANALOG RIGHT CHANNEL INPUT
E4	NC			NO CONNECT (MUST BE LEFT FLOATING)
E5	LHP	A	O	LEFT HEADPHONE OUTPUT
E6	AGND	A	P	ANALOG GROUND
F1	DIFF+	A	I	ANALOG POSITIVE DIFFERENTIAL INPUT
F2	EP-	A	O	MONO EARPIECE- OUTPUT
F3	EP+	A	O	MONO EARPIECE+ OUTPUT
F4	LS-	A	O	LOUDSPEAKER OUTPUT-
F5	AV _{DD}	A	P	ANALOG SUPPLY VOLTAGE
F6	LS+	A	O	LOUDSPEAKER OUTPUT+

Absolute Maximum Ratings (Note 1, Note 2)

2)

If Military/Aerospace specified devices are required, please contact the National Semiconductor Sales Office/Distributors for availability and specifications.

Analog Supply Voltage (Note 1)	6.0V
Digital Supply Voltage (Note 1)	6.0V
Storage Temperature	-65°C to +150°C
Input Voltage	-0.3V to $V_{DD} + 0.3V$
Power Dissipation (Note 3)	Internally Limited
ESD Ratings (Note 4)	2000V
ESD Ratings (Note 5)	200V
Junction Temperature (T_{JMAX})	150°C
Thermal Resistance	

 θ_{JA} (RLA36)

100°C/W

Soldering Information

See AN-1279 "Microfill Wafer Level Underfilled Chip Scale package."

Operating Ratings (Note 1, Note 2)

Temperature Range

 $T_{MIN} \leq T_A \leq T_{MAX}$ $-40^\circ\text{C} \leq T_A \leq +85^\circ\text{C}$

Supply Voltage

 $2.7V \leq AV_{DD} \leq 5.5V$ $2.7V \leq DV_{DD} \leq 4.0V$ $1.7V \leq I^2C_V_{DD} \leq 4.0V$ $1.7V \leq I/O_V_{DD} \leq 4.0V$

Audio Amplifier Electrical Characteristics $AV_{DD} = 3.0V$, $DV_{DD} = 3.0V$ (Note 1, Note 2)

2)

The following specifications apply for the circuit shown in Figure 1 with all programmable gain set at 0dB, unless otherwise specified. Limits apply for $T_A = 25^\circ\text{C}$.

Symbol	Parameter	Conditions	LM49321		Units (Limits)
			Typical (Note 6)	Limits (Note 7)	
I_{DD}	Supply Current	$V_{IN} = 0$, No Load All Amps On + DAC, OCL (Note 10)	13	18	mA (max)
		Headphone Mode Only, OCL, DAC off	4.6	6.25	mA (max)
		Headphone Mode Only, OCL, DAC Off STEREO_OUTPUT_ONLY = 1, STEREO_INPUT_ONLY = 1	4	5.5	mA
		Headphone Mode only OCL, DAC On, OSR = 64, DAC_INPUT_ONLY = 1 STEREO_OUTPUT_ONLY = 1	7.5	10	mA (max)
		Mono Loudspeaker Mode Only (Note 11)	6.5	11.5	mA (max)
		Mono Earpiece Speaker Mode Only MONO_ONLY = 1 (register 01h) MONO_ONLY = 0	3.7 3.3	5	mA (max) mA
		DAC Off, All Amps On (OCL) (Note 10)	10	13.5	mA (max)
I_{SD}	Shutdown Current	(Note 8)	0.6	1	μA (max)
P_O	Output Power	Speaker; THD = 1%; f = 1kHz, 8 Ω BTL	420	370	mW (min)
		Headphone; THD = 1%; f = 1kHz, 32 Ω SE	27	24	mW (min)
		Earpiece; THD = 1%; f = 1kHz, 32 Ω BTL	45	40	mW (min)
$V_{FS\ DAC}$	Full Scale DAC Output		2.4		V_{RMS}
THD+N	Total Harmonic Distortion+Noise	Speaker; $P_O = 200\text{mW}$; f = 1kHz, 8 Ω BTL	0.04		%
		Headphone; $P_O = 10\text{mW}$; f = 1kHz, 32 Ω SE	0.01		%
		Earpiece; $P_O = 20\text{mW}$; f = 1kHz, 32 Ω BTL	0.04		%
V_{OS}	Offset Voltage	Speaker	10	55	mV (max)
		Earpiece	8	50	mV (max)
		Headphone (OCL)	8	15	mV (max)
ϵ_O	Output Noise	A-weighted; 0dB gain	Table 1		
PSRR	Power Supply Rejection Ratio	f = 217Hz; $V_{RIPPLE} = 200\text{mV}_{P-P}$ $C_B = 2.2\mu\text{F}$	Table 2		

Symbol	Parameter	Conditions	LM49321		Units (Limits)
			Typical (Note 6)	Limits (Note 7)	
X _{TALK}	Crosstalk	Headphone; P _O = 10mW, f = 1kHz; OCL	-60		dB
T _{WU}	Wake-Up Time	C _B = 2.2μF, CD ₆ = 0	35		ms
		C _B = 2.2μF, CD ₆ = 1	85		ms
CMRR	Common-Mode Rejection Ratio	f = 217Hz, V _{RMS} = 200mV _{PP}	56		dB

Audio Amplifier Electrical Characteristics AV_{DD} = 5.0V, DV_{DD} = 3.3V (Note 1, Note 2)

The following specifications apply for the circuit shown in Figure 1 with all programmable gain set at 0dB, unless otherwise specified. Limits apply for T_A = 25°C.

Symbol	Parameter	Conditions	LM49321		Units (Limits)
			Typical (Note 6)	Limits (Note 7)	
I _{DD}	Supply Current	V _{IN} = 0, No Load All Amps On + DAC, OCL (Note 10)	17.5		mA (max)
		Headphone Mode Only, OCL, DAC Off	5.8		mA (max)
		Headphone Mode Only, OCL, DAC Off STEREO_OUTPUT_ONLY = 1, STEREO_INPUT_ONLY = 1	5.5		mA
		Headphone Mode Only, OCL, DAC On, OSR = 64, DAC_INPUT_ONLY = 1 STEREO_OUTPUT_ONLY = 1	9.5		mA
		Mono Loudspeaker Mode Only (Note 10)	11.6		mA
		Mono Earpiece Mode Only (Note 10)	5		mA
		DAC Off, All Amps On (OCL) (Note 10)	12.9		mA
I _{SD}	Shutdown Current	(Note 8)	1.6		μA
P _O	Output Power	Speaker; THD = 1%; f = 1kHz, 8Ω BTL	1.25		mW
		Headphone; THD = 1%; f = 1kHz, 32Ω SE	80		mW
		Earpiece; THD = 1%; f = 1kHz, 32Ω BTL	175		mW
V _{FS DAC}	Full Scale DAC Output		2.4		V _{RMS}
THD+N	Total Harmonic Distortion + Noise	Speaker; P _O = 500mW; f = 1kHz, 8Ω BTL	0.03		%
		Headphone; P _O = 30mW; f = 1kHz, 32Ω SE	0.01		%
		Earpiece; P _O = 40mW; f = 1kHz, 32Ω BTL	0.04		%
V _{OS}	Offset Voltage	Speaker	10		mV
		Earpiece	8		mV
		HP (OCL)	8		mV
ε _O	Output Noise	A-weighted; 0dB gain;	Table 1		
PSRR	Power Supply Rejection Ratio	f = 217Hz; V _{ripple} = 200mV _{P-P} C _B = 2.2μF	Table 3		
X _{TALK}	Crosstalk	Headphone; P _O = 15mW, f = 1kHz; OCL	-56		dB
T _{WU}	Wake-Up Time	C _B = 2.2μF, CD ₆ = 0	45		ms
		C _B = 2.2μF, CD ₆ = 1	130		ms

Volume Control Electrical Characteristics (Note 1, Note 2)

The following specifications apply for $3.0V \leq AV_{DD} \leq 5.0V$ and $2.7V \leq DV_{DD} \leq 4.0V$, unless otherwise specified. Limits apply for $T_A = 25^\circ C$.

Symbol	Parameter	Conditions	LM49321		Units (Limits)
			Typical (Note 6)	Limits (Note 7)	
PGR	Stereo Analog Inputs Pre-Amp Gain Setting Range	minimum gain setting	-6	-7	dB (min)
				-5	dB (max)
	Differential Mono Analog Input Pre-Amp Gain Setting Range	maximum gain setting	15	15.5	dB (max)
				14.5	dB (min)
		minimum gain setting	-12	-13	dB (min)
				-11	dB (max)
maximum gain setting	9	9.5	dB (max)		
		8.5	dB (min)		
VCR	Output Volume Control for Loudspeaker, Headphone Output, or Earpiece Output	minimum gain setting	-56	-59	dB (min)
				-53	dB (max)
	maximum gain setting	+5	4.5	dB (min)	
			5.5	dB (max)	
ΔA_{CH-CH}	Stereo Channel to Channel Gain Mismatch		0.3		dB
A_{MUTE}	Mute Attenuation	$V_{IN} = 1V_{RMS}$, Gain = 0dB with load, Headphone	-90		dB
R_{INPUT}	DIFF+, DIFF-, L_{IN} and R_{IN} Input Impedance		23	18	k Ω (min)
				28	k Ω (max)

Digital Section Electrical Characteristics (Note 1, Note 2)

The following specifications apply for $3.0V \leq AV_{DD} \leq 5.0V$ and $2.7V \leq DV_{DD} \leq 4.0V$, unless otherwise specified. Limits apply for $T_A = 25^\circ C$.

Symbol	Parameter	Conditions	LM49321		Units (Limits)
			Typical (Note 6)	Limits (Note 7)	
DI_{SD}	Digital Shutdown Current	Mode 0, $DV_{DD} = 3.0V$			
		No MCLK	0.01		μA
DI_{DD}	Digital Power Supply Current	$f_{MCLK} = 12MHz$, $DV_{DD} = 3.0V$ ALL MODES EXCEPT 0	5.3	6.5	mA (max)
$PLLI_{DD}$	PLL Quiescent Current	$f_{MCLK} = 12MHz$, $DV_{DD} = 3.0V$	4.8	6	mA (max)

Audio DAC (Typical numbers are with 6.144MHz audio clock and 48kHz sampling frequency)

R_{DAC}	Audio DAC Ripple	20Hz - 20kHz through headphone output	+/-0.1		dB
PB_{DAC}	Audio DAC Passband width	-3dB point	22.6		kHz
SBA_{DAC}	Audio DAC Stop band Attenuation	Above 24kHz	76		dB
DR_{DAC}	Audio DAC Dynamic Range	DC - 20kHz, -60dBFS; AES17 Standard	Table 4		dB
SNR	Audio DAC-AMP Signal to Noise Ratio	A-Weighted, Signal = V_O at 0dBFS, $f = 1kHz$ Noise = digital zero, A-weighted	Table 4		dB
SNR_{DAC}	Internal DAC SNR	A-weighted (Note 9)	95		dB

PLL

f_{IN}	Input Frequency on MCLK pin		12	10	MHz
				26	

SPI/I²C (1.7V \leq I²C_ $V_{DD} \leq$ 2.2V)

f_{SPI}	Maximum SPI Frequency			1000	kHz (max)
$t_{SPISETD}$	SPI Data Setup Time			250	ns (max)
$t_{SPISETENB}$	SPI ENB Setup Time			250	ns (max)

Symbol	Parameter	Conditions	LM49321		Units (Limits)
			Typical (Note 6)	Limits (Note 7)	
t_{SPIHOLDD}	SPI Data Hold Time			250	ns (max)
$t_{\text{SPIHOLDENB}}$	SPI ENB Hold Time			250	ns (max)
t_{SPICL}	SPI Clock Low Time			500	ns (max)
t_{SPICH}	SPI Clock High Time			500	ns (max)
$f_{\text{CLKI}^2\text{C}}$	I ² C_CLK Frequency			400	kHz (max)
$t_{\text{I}^2\text{C}}\text{HOLD}$	I ² C_DATA Hold Time			250	ns (max)
$t_{\text{I}^2\text{C}}\text{SET}$	I ² C_DATA Setup Time			250	ns (max)
V_{IH}	I ² C/SPI Input High Voltage		I ² C_V _{DD}	0.7 x I ² C_V _{DD}	V (min)
V_{IL}	I ² C/SPI Input Low Voltage		0	0.25 x I ² C_V _{DD}	V (max)
SPI/I²C (2.2V ≤ I²C_V_{DD} ≤ 4.0V)					
f_{SPI}	Maximum SPI Frequency			4000	kHz (max)
t_{SPISETD}	SPI Data Setup Time			100	ns (max)
$t_{\text{SPISETENB}}$	SPI ENB Setup Time			100	ns (max)
t_{SPIHOLDD}	SPI Data Hold Time			100	ns (max)
$t_{\text{SPIHOLENB}}$	SPI ENB Hold Time			100	ns (max)
t_{SPICL}	SPI Clock Low Time			125	ns (max)
t_{SPICH}	SPI Clock High Time			125	ns (max)
$f_{\text{CLKI}^2\text{C}}$	I ² C_CLK Frequency			400	kHz (max)
$t_{\text{I}^2\text{C}}\text{HOLD}$	I ² C_DATA Hold Time			100	ns (max)
$t_{\text{I}^2\text{C}}\text{SET}$	I ² C_DATA Setup Time			100	ns (max)
V_{IH}	I ² C/SPI Input High Voltage		I ² C_V _{DD}	0.7 x I ² C_V _{DD}	V (min)
V_{IL}	I ² C/SPI Input Low Voltage		0	0.3 x I ² C_V _{DD}	V (max)
I²S (1.7V ≤ I/O_V_{DD} ≤ 2.7V)					
$f_{\text{CLKI}^2\text{S}}$	I ² S_CLK Frequency	I ² S_RESOLUTION = 1	1536	6144	kHz (max)
		I ² S_RESOLUTION = 0	3072	12288	kHz (max)
	I ² S_WS Duty Cycle		50	40 60	% (min) % (max)
V_{IH}	Digital Input High Voltage			0.75 x I/O_V _{DD}	V (min)
V_{IL}	Digital Input Low Voltage			0.25 x I/O_V _{DD}	V (max)
I²S (2.7V ≤ I/O_V_{DD} ≤ 4.0V)					
$f_{\text{CLKI}^2\text{S}}$	I ² S_CLK Frequency	I ² S_RESOLUTION = 0	1536 3072	6144 12288	kHz (max) kHz (max)
	I ² S_WS Duty Cycle	I ² S_RESOLUTION = 1	50	40 60	% %
V_{IH}	Digital Input High Voltage			0.7 x I/O_V _{DD}	V (min)
V_{IL}	Digital Input Low Voltage			0.3 x I/O_V _{DD}	V (max)

Note 1: "Absolute Maximum Ratings" indicate limits beyond which damage to the device may occur, including inoperability and degradation of device reliability and/or performance. Functional operation of the device and/or non-degradation at the *Absolute Maximum Ratings* or other conditions beyond those indicated in the *Recommended Operating Conditions* is not implied. The *Recommended Operating Conditions* indicate conditions at which the device is functional and the device should not be operated beyond such conditions. All voltages are measured with respect to the ground pin, unless otherwise specified.

Note 2: The *Electrical Characteristics* tables list guaranteed specifications under the listed *Recommended Operating Conditions* except as otherwise modified or specified by the *Electrical Characteristics Conditions* and/or Notes. Typical specifications are estimations only and are not guaranteed.

Note 3: Maximum allowable power dissipation is $P_{\text{DMAX}} = (T_{\text{JMAX}} - T_{\text{A}}) / \theta_{\text{JA}}$ or the number given in *Absolute Maximum Ratings*, whichever is lower.

Note 4: Human body model, applicable std. JESD22-A114C.

Note 5: Machine model, applicable std. JESD22-A115-A.

Note 6: Typical values represent most likely parametric norms at $T_{\text{A}} = +25^{\circ}\text{C}$, and at the *Recommended Operation Conditions* at the time of product characterization and are not guaranteed.

Note 7: Datasheet min/max specification limits are guaranteed by test or statistical analysis.

Note 8: Shutdown current is measured in a normal room environment.

Note 9: Internal DAC only with DAC modes 00 and 01.

Note 10: Enabling mono bit (MONO_ONLY in Output Control Register 01h) will save 400 μA (typ) from specified current.

TABLE 1. Output Noise

Output Noise $AV_{DD} = 5.0V$ and $AV_{DD} = 3.0V$. All gains set to 0dB. Units in μV , A-weighted, Inputs terminated to ground.

MODE	EP	LS	HP OCL	Units
1	22	22	8	μV
2	22	22	8	μV
3	22	22	8	μV
4	68	88	46	μV
5	38	48	24	μV
6	29	34	18	μV
7	38	48	24	μV

TABLE 2. PSRR $AV_{DD} = 3.0V$ PSRR $AV_{DD} = 3.0V$, $f_{RIPPLE} = 217Hz$; $V_{RIPPLE} = 200mV_{p-p}$; $C_B = 2.2\mu F$; All gains set to 0dB..

MODE	EP(Typ)	LS (Typ)	LS (Limit)	HP (Typ)	HP (Limit)	Units
1	69	76		72		dB
2	69	76	67	72	68	dB
3	69	76		72		dB
4	63	62		55		dB
5	69	68		61		dB
6	69	70		64		dB
7	69	68		61		dB

TABLE 3. PSRR $AV_{DD} = 5.0V$ PSRR $AV_{DD} = 5.0V$, $f_{RIPPLE} = 217Hz$; $V_{RIPPLE} = 200mV_{p-p}$; $C_B = 2.2\mu F$; All gains set to 0dB,

MODE	EP (Typ)	LS (Typ)	HP (Typ)	Units
1	68	72	71	dB
2	68	72	71	dB
3	68	72	71	dB
4	68	66	69	dB
5	68	69	70	dB
6	69	72	71	dB
7	68	69	70	dB

TABLE 4. Dynamic Range and SNR

Dynamic Range and SNR. $3.0V \leq AV_{DD} \leq 5.0V$. All programmable gain set to 0dB. Units in dB.

	DR (Typ)	SNR (Typ)	Units
LS	95	85	dB
HP	95	85	dB
EP	97	85	dB

System Control

The LM49321 is controlled via either a two wire I²C compatible interface or three wire SPI interface, selectable with the MODE pin. This interface is used to configure the operating mode, interfaces, data converters, mixers and amplifiers. The LM49321 is controlled by writing 8 bit data into a series of write-only registers, the device is always a slave for both type of interfaces.

THREE WIRE, SPI INTERFACE (MODE = 1)

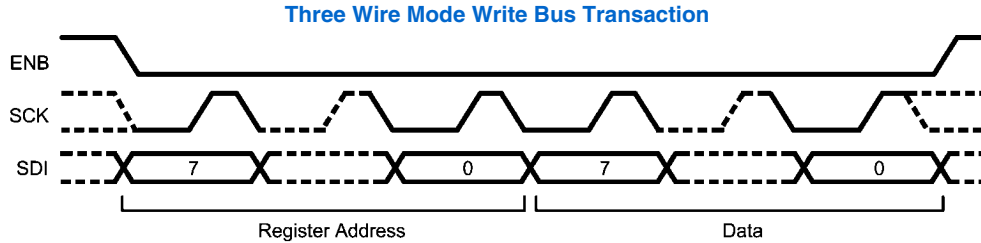

30061859

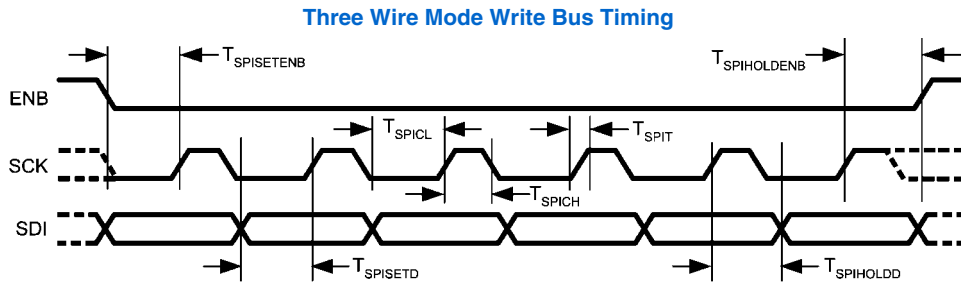

30061860

Three Wire Mode Write Bus

When the part is configured as an SPI device and the enable (ENB) line is lowered the serial data on SDI is clocked in on the rising edge of the SCK line. The protocol used is 16bit, MSB first. The upper 8 bits (15:8) are used to select an address within the device, the lower 8 bits (7:0) contain the updated data for this register.

TWO WIRE I²C COMPATIBLE INTERFACE (MODE = 0)

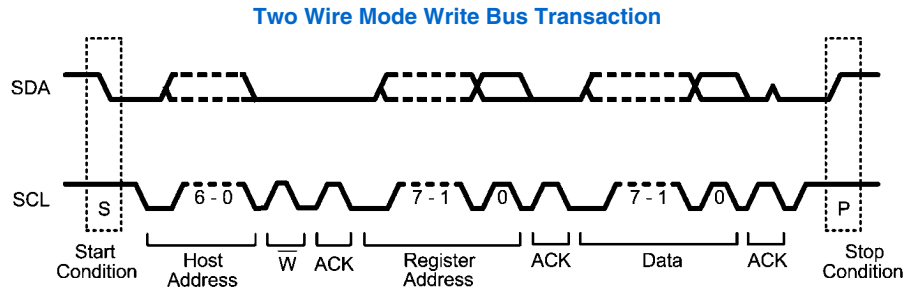

300618j6

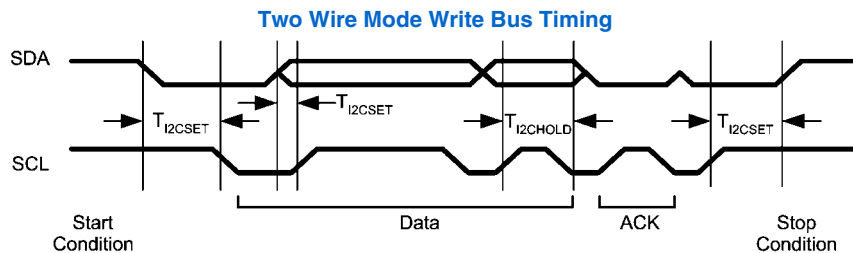

30061862

Two Wire Mode Write Bus

When the part is configured as an I²C device then the LM49321 will respond to one of two addresses, according to the ADDR input. If ADDR is low then the address portion of the I²C transaction should be set to write to 0010000. When ADDR is high then the address input should be set to write to 1110000.

TABLE 5. Chip Address

	A7	A6	A5	A4	A3	A2	A1	A0
Chip Address	0	EC	EC	1	0	0	0	0
ADR = 0	0	0	0	1	0	0	0	0
ADR = 1	0	1	1	1	0	0	0	0

EC — Externally configured by ADR pin

TABLE 6. Control Registers

Address	Register	D7	D6	D5	D4	D3	D2	D1	D0
00h	MODE_CONTROL	0	CD_6	0	OCL		MODE_CONTROL		
01h	OUTPUT_CONTROL	STEREO_OUT_ONLY	MONO_ONLY	DAC_INPUT_ONLY	STEREO_INPUT_ONLY	HP_R_OUTPUT	HP_L_OUTPUT	LS_OUTPUT	MONO_OUTPUT
02h	EP_VOL	0	0	0		EP_VOL			
03h	LS_VOL	0	0	0		LS_VOL			
04h	RESERVED	0	0	0	0	0	0	0	0
05h	HP_L_VOL	0	0	0		HP_L_VOL			
06h	HP_R_VOL	0	0	0		HP_R_VOL			
07h	ANALOG_INPUT_GAIN	0	0		ANA_R_GAIN				ANA_L_GAIN
08h	ANALOG_DAC_GAIN	0		DAC_R_GAIN		DAC_L_GAIN			MONO_L_GAIN
09h	CLOCKS			R_DIV		PLL_ENABLE	AUDIO_CLK_SEL	PLL_INPUT	FAST_CLOCK
0Ah	PLL_M	0				PLL_M			
0Bh						PLL_N			
0Ch	PLL_N_MOD	VCO_FAST	DITHER_LEVEL	DITHER_LEVEL			PLL_N_MOD		
0Dh	PLL_P	0	0	0	0		PLL_P		
0Eh	DAC_SET UP	0	CUST_COMP	DITHER_ALW_ON	DITHER_OFF	MUTE_R	MUTE_L	DAC_MODE	
0Fh	INTERFACE	0	0	0	0	I ² C_FAST	I ² S_MODE	I ² S_RESOLUTION	I ² S_MASTER_SLAVE
10h				COMPENSATION_C_OEFF0_LSB					
11h				COMPENSATION_C_OEFF0_MSB					
12h				COMPENSATION_C_OEFF1_LSB					
13h				COMPENSATION_C_OEFF1_MSB					
14h				COMPENSATION_C_OEFF2_LSB					
15h				COMPENSATION_C_OEFF2_MSB					

Note: All registers default to 0 on initial power-up.

Mixer Control Registers

TABLE 7. Mode Control Register (00h)

This register is used to control the different mixer modes that the LM49321 supports.

Bits	Field	Description					
3:0	MODE _CONTROL	This sets the different mixer output modes.					
		MODE_CONTROL	Mode	Mono Earpiece	Loudspeaker	Headphone Left	Headphone Right
		0000	0	SD	SD	SD	SD
		1001	1	M	M	M	M
		1010	2	AL+AR	AL+AR	AL	AR
		1011	3	M+AL+AR	M+AL+AR	M+AL	M+AR
		1100	4	DL+DR	DL+DR	DL	DR
		1101	5	DL+DR+AL+AR	DL+DR+AL+AR	DL+AL	DR+AR
		1110	6	M+DL+DR+AL +AR	M+DL+DR+AL +AR	M+DL+AL	M+DR+AR
1111	7	M+DL+DR	M+DL+DR	M+DL	M+DR		
4	OCL	This sets the headphone output to use output capacitor-less configuration.					
		OCL		Headphone output configuration			
		0		Cap-coupled Single-ended Mode (SE)			
		1		Output capacitor-less (OCL)			

SD — Shutdown

M — Mono Differential Input

AL — Analog Left Channel

AR — Analog Right Channel

DL — I²S DAC Left Channel

DR — I²S DAC Right Channel

Note: Power-On Default Mode is Mode 0

TABLE 8. Output Control (01h)

This register is used to control the different output configurations.

Bits	Field	Description	
0	EP_OUTPUT	This enables the Mono Earpiece output.	
		EP_OUTPUT	Status
		0	Mono earpiece output off
		1	Mono earpiece output on
1	LS_OUTPUT	This enables the Mono Loudspeaker output.	
		LS_OUTPUT	Status
		0	Loudspeaker output off
		1	Loudspeaker output on
2	HP_L_OUTPUT	This enables the Headphone left output.	
		HP_L_OUTPUT	Status
		0	Headphone left output off. If OCL=1, output is in mute.
		1	Headphone left output on
3	HP_R_OUTPUT	This enables the Headphone right output.	
		HP_R_OUTPUT	Status
		0	Headphone right output off. If OCL=1, output is in mute.
		1	Headphone right output on

Bits	Field	Description	
4	STEREO_INPUT_ONLY	This enables the analog left (AL) and analog right (AR) and disables all other inputs.	
		STEREO_INPUT_ONLY	Status
		0	Normal
		1	Enables AL and AR inputs only
5	DAC_INPUT_ONLY	This enables the DAC left (DL) and analog right (DR) and disables all other inputs.	
		DAC_INPUT_ONLY	Status
		0	Normal
		1	Enables DL and DR inputs only
6	MONO_ONLY	This enables mono earpiece (EP) and loudspeaker (LS) outputs MUX and disables the headphone outputs MUX. Enabling this mode can save up to 400 μ A of current.	
		MONO_ONLY	Status
		0	Normal
		1	Enable mono earpiece and loudspeaker outputs MUX
7	STEREO_OUTPUT_ONLY	This enables the headphone output MUX only and disables all other output MUX's. Enabling this mode can save up to 200 μ A of current.	
		STEREO_OUTPUT_ONLY	Status
		0	Normal
		1	Enables the headphone output MUX

Volume Control Registers

TABLE 9. Volume Control Register
EP_VOL (02h), LS_VOL (03h), HP_L_VOL (05h), HP_R_VOL (06h)

These registers are used to control output volume control levels for Earpiece, Loudspeaker and Headphone.

Bits	Field	Description	
4:0	EP_VOL LS_VOL HP_L_VOL HP_R_VOL	This programs the Earpiece, Loudspeaker and Headphone volume level.	
		VOL	Level (dB)
		00000	MUTE
		00001	-56
		00010	-52
		00011	-48
		00100	-45
		00101	-42
		00110	-39
		00111	-36
		01000	-33
		01001	-30
		01010	-28
		01011	-26
		01100	-24
		01101	-22
		01110	-20
		01111	-18
		10000	-16
		10001	-14
		10010	-12
		10011	-10
		10100	-8
		10101	-6
		10110	-4
10111	-3		
11000	-2		
11001	-1		
11010	0		
11011	1		
11100	2		
11101	3		
11110	4		
11111	5		

TABLE 10. Analog Left and Right Input Control (07h)

This register is used to control input gain for left and right analog inputs.

Bits	Field	Description	
2:0	ANA_L_GAIN	This program the analog left input gain.	
		ANA_L_GAIN	Level (dB)
		000	-6
		001	-3
		010	0
		011	3
		100	6
		101	9
		110	12
111	15		
5:3	ANA_R_GAIN	This program the analog Right input gain.	
		ANA_R_GAIN	Level (dB)
		000	-6
		001	-3
		010	0
		011	3
		100	6
		101	9
		110	12
111	15		

TABLE 11. Mono and DAC Input Gain Control (08h)

This register is used to control input gain for Mono, DAC left and right inputs.

Bits	Field	Description	
2:0	MONO_IN_GAIN	This program the mono input gain.	
		MONO_IN_GAIN	Level (dB)
		000	-12
		001	-9
		010	-6
		011	-3
		100	0
		101	3
		110	6
111	9		
4:3	DAC_L_GAIN	This program the DAC left input gain.	
		DAC_L_GAIN	Level (dB)
		00	-3
		01	0
		10	3
11	6		
6:5	DAC_R_GAIN	This program the DAC Right input gain.	
		DAC_R_GAIN	Level (dB)
		00	-3
		01	0
		10	3
11	6		

Clock Configuration Register

This register is used to control the multiplexers and clock R divider in the clock module.

TABLE 12. CLOCK (09h)

Bits	Register	Description	
0	FAST_CLOCK	If set master clock is divided by two.	
		FAST_CLOCK	MCLK Frequency
		0	Normal
		1	Divided by 2
1	PLL_INPUT	Programs the PLL input multiplexer to select:	
		PLL_INPUT	PLL Input Source
		0	MCLK
		1	I ² S Input Clock
2	AUDIO_CLK_SEL	Selects which clock is passed to the audio sub-system	
		DAC_CLK_SEL	DAC Sub-system Input Source
		0	PLL Input
		1	PLL Output
3	PLL_ENABLE	If set enables the PLL. (MODES 4–7 only)	
7:4	R_DIV	Programs the R divider	
		R_DIV	Divide Value
		0000	1
		0001	1
		0010	1.5
		0011	2
		0100	2.5
		0101	3
		0110	3.5
		0111	4
		1000	4.5
		1001	5
		1010	5.5
		1011	6
		1100	6.5
		1101	7
1110	7.5		
1111	8		

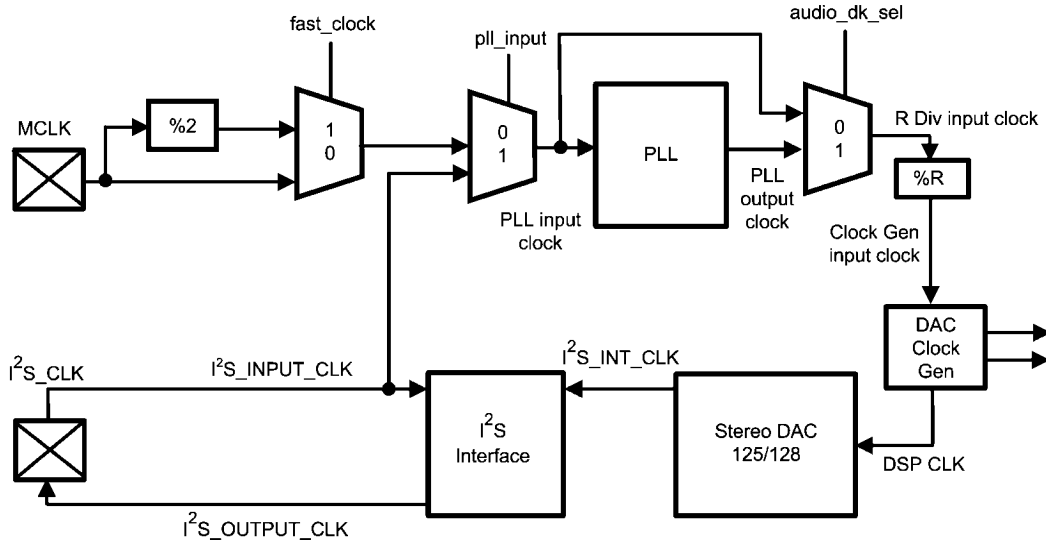

30061853

By default the stereo DAC operates at $250 \cdot f_s$, i.e. 12.000MHz (at the clock generator input clock) for 48kHz data. It is expected that the PLL be used to drive the audio system unless a 12.000MHz master clock is supplied. The PLL can also use the I2S clock input as a source. In this case, the audio DAC uses the clock from the output of the PLL.

Common Clock Settings for the DAC

The DAC can work in 4 modes, each with different oversampling rates, 125, 128, 64 & 32. In normal operation 125x oversampling provides for the simplest clocking solution as it will work from 12.000MHz (common in most systems with Bluetooth or USB) at 48kHz exactly. The other modes are useful if data is being provided to the DAC from an uncontrollable isochronous source (such as a CD player, DAB, or other external digital source) rather than being decoded from memory. In this case the PLL can be used to derive a clock for the DAC from the I2S clock.

The DAC oversampling rate can be changed to allow simpler clocking strategies, this is controlled in the DAC SETUP register but the oversampling rates are as follows:

TABLE 13.

DAC MODE	Over sampling Ratio Used
00	125
01	128
10	64
11	32

The following table describes the clock required at the clock generator input for various clock sample rates in the different DAC modes:

TABLE 14.

Fs (kHz)	DAC Oversampling Ratio	Required CLock at DAC Clock Generator Input (MHz)
8	125	2
8	128	2.048
11.025	125	2.75625
11.025	128	2.8224
12	125	3
12	128	3.072
16	125	4
16	128	4.096
22.05	125	5.5125
22.05	128	5.6448

Fs (kHz)	DAC Oversampling Ratio	Required CLock at DAC Clock Generator Input (MHz)
24	125	6
24	128	6.144
32	125	8
32	128	8.192
44.1	125	11.025
44.1	128	11.2896
48	125	12
48	128	12.288
88.2	64	11.2896
96	64	12.288
176.4	32	22.5792
192	32	24.576

Methods for producing these clock frequencies are described in the PLL section.

The R divider can be used when the master clock is exactly 12.00 MHz in order to generate different sample rates. The Table below shows different sample rates supported from 12.00MHz by using only the R divider and disabling the PLL. In this way we can save power and the clock jitter will be low.

TABLE 15.

R_DIV	Divide Value	DAC Clock Generator Input Frequency <MHz>	Sample Rate Supported <KHz>
11	6	2	8
9	5	2.4	9.6
7	4	3	12
5	3	4	16
4	2.5	4.8	19.2
3	2	6	24
2	1.5	8	32
0	1	12	48

The R divider can also be used along with the P divider in order to create the clock needed to support low sample rates.

PLL Configuration Registers

PLL M DIVIDER CONFIGURATION REGISTER

This register is used to control the input divider of the PLL.

TABLE 16. PLL_M (0Ah)

Bits	Register	Description	
6:0	PLL_M	Programs the PLL input divider to select:	
		PLL_M	Divide Ratio
		0000000	Divider Off
		0000001	1
		0000010	1.5
		0000011	2
		0000100	2.5
	
		1111110	63.5

NOTES:

The M divider should be set such that the output of the divider is between 0.5 and 5MHz. See the PLL setup section for details.

The division of the M divider is derived from PLL_M as such:

$$M = (\text{PLL_M} + 1) / 2$$

PLL N DIVIDER CONFIGURATION REGISTER

This register is used to control PLL N divider.

TABLE 17. PLL_N (0Bh)

Bits	Register	Description	
7:0	PLL_N	Programs the PLL feedback divider:	
		PLL_N	Divide Ratio
		00000000	Divider Off
		00000001 → 00001010	10
		00001011	11
		00001100	12
	
		11111000	248
		11111001	249

NOTES:

The N divider should be set such that the output of the divider is between 0.5 and 5MHz. See the PLL setup section for details. The N divider should never be set so that $(F_{in}/M) * N > 55\text{MHz}$ (or 80MHz if FAST_VCO is set in the PLL_N_MOD register).

The non-sigma-delta division of the N divider is derived from the PLL_N as such:

$$N = \text{PLL_N}$$

F_{in}/M is often referred to as F_{comp} (Frequency of Comparison) or F_{ref} (Reference Frequency). In this document, F_{comp} is used.

PLL P DIVIDER CONFIGURATION REGISTER

This register is used to control the PLL's P divider.

TABLE 18. PLL_P

Bits	Register	Description	
3:0	PLL_P	Programs the PLL input divider to select:	
		0000	Divider Off
		0001	1
		0010	1.5
		0011	2
		...	→ 2.5
		1101	7
		1110	7.5
		1111	8

NOTES:

The output of this divider should be either 12 or 24MHz in USB mode or 11.2896MHz, 12.288MHz or 24.576MHz in non-USB modes.

The division of the P divider is derived from PLL_P as such:

$$P = (\text{PLL_P} + 1) / 2$$

PLL N MODULATOR AND DITHER SELECT CONFIGURATION REGISTER

This register is used to control the Fractional component of the PLL.

TABLE 19. PLL_N_MOD (0Ch)

Bits	Register	Description	
4:0	PLL_N_MOD	This programs the PLL N Modulator's fractional component:	
		PLL_N_MOD	Fractional Addition
		00000	0/32
		00001	1/32
		00010 → 11110	2/32 → 30/32

Bits	Register	Description	
6:5	DITHER_LEVEL	Allows control over the dither used by the N Modulator	
		DITHER_LEVEL	DAC Sub-system Input Source
		00	Medium (32)
		01	Small (16)
		10	Large (48)
7	VCO_FAST	If set the VCO maximum and minimum frequencies are raised:	
		VCO_FAST	Maximum F_{VCO}
		0	40–55MHz

NOTES:

The complete N divider is a fractional divider as such:

$$N = \text{PLL_N} + (\text{PLL_N_MOD}/32)$$

If the modulus input is zero, then the N divider is simply an integer N divider. The output from the PLL is determined by the following formula:

$$F_{out} = (F_{in} * N) / (M * P)$$

Please see over for more details on the PLL and common settings.

Further Notes on PLL Programming

The sigma-delta PLL is designed to drive audio circuits requiring accurate clock frequencies of up to 25MHz with frequency errors noise-shaped away from the audio band. The 5 bits of modulus control provide exact synchronization of 48kHz and 44.1kHz sample rates from any common clock source when the oversampling rate of the audio system is 125fs. In systems where 128x oversampling must be used (for example with an isochronous I²S data stream) a clock synchronous to the sample rate should be used as input to the PLL (typically the I²S clock). If no isochronous source is available then the PLL can be used to obtain a clock that is accurate to within typical crystal tolerances of the real sample rate.

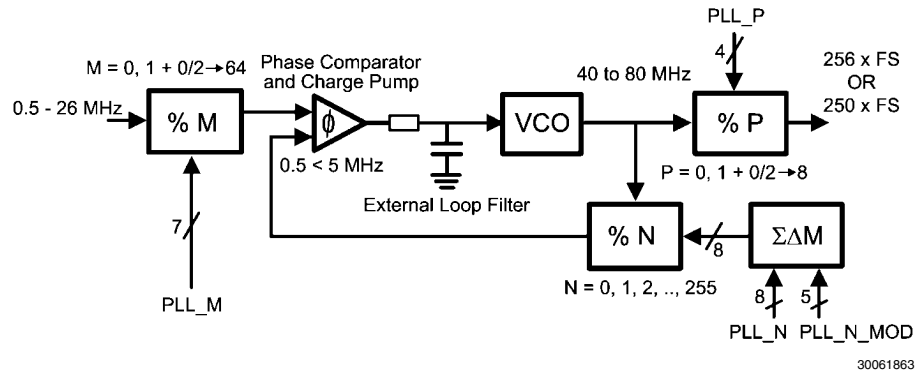

TABLE 20. Example Of PLL Settings For 48Khz Sample Rates

f_in (MHz)	fsamp (kHz)	M	N	P	PLL_M	PLL_N	PLL_N_MOD	PLL_P	f_out (MHz)
11	48	11	60	5	21	60	0	9	12
12	48	5	25	5	9	25	0	9	12
12.288	48	4	19.53125	5	7	19	17	9	12
13	48	13	60	5	25	60	0	9	12
14.4	48	9	37.5	5	17	37	16	9	12
16.2	48	27	100	5	53	100	0	9	12
16.8	48	14	50	5	27	50	0	9	12
19.2	48	13	40.625	5	25	40	20	9	12
19.44	48	27	100	6	53	100	0	11	12
19.68	48	20.5	62.5	5	40	62	16	9	12
19.8	48	16.5	50	5	32	50	0	9	12

TABLE 21. Example PLL Settings For 44.1Khz Sample Rates

f_in (MHz)	fsamp (kHz)	M	N	P	PLL_M	PLL_N	PLL_N_MOD	PLL_P	f_out (MHz)
11	44.1	11	55.125	5	21	55	4	9	11.025000
11.2896	44.1	8	39.0625	5	15	39	2	9	11.025000
12	44.1	5	22.96875	5	9	22	31	9	11.025000
13	44.1	13	55.125	5	25	55	4	9	11.025000
14.4	44.1	12	45.9375	5	23	45	30	9	11.025000
16.2	44.1	9	30.625	5	17	30	20	9	11.025000
16.8	44.1	17	55.78125	5	33	55	25	9	11.025000
19.2	44.1	16	45.9375	5	31	45	30	9	11.025000
19.44	44.1	13.5	38.28125	5	26	38	9	9	11.025000
19.68	44.1	20.5	45.9375	4	40	45	30	7	11.025000
19.8	44.1	11	30.625	5	21	30	20	9	11.025000

These tables cover the most common applications, obtaining clocks for sample rates such as 22.05kHz and 192kHz should be done by changing the P divider value or the R divider in the clock configuration diagram.

If the user needs to obtain a clock unrelated to those described above, the following method is advised. An example of obtaining 11.2896 from 12.000MHz is shown below.

Choose a small range of P so that the VCO frequency is swept between 45 and 55MHz (or 60-80MHz if VCOFAST is used). Remembering that the P divider can divide by half integers. So for P = 4.0 → 7.0 sweep the M inputs from 2.5 → 24. The most accurate N and N_MOD can be calculated by:

$$N = \text{FLOOR}(((F_{\text{out}}/F_{\text{in}})*(P*M)),1)$$

$$N_{\text{MOD}} = \text{ROUND}(32*(((F_{\text{out}}/F_{\text{in}})*(P*M)-N),0)$$

This shows that setting M = 11.5, N = 75 N_MOD = 47 P = 7 gives a comparison frequency of just over 1MHz, a VCO frequency of just under 80MHz (so VCO_FAST must be set) and an output frequency of 11.289596 which gives a sample rate of 44.099985443kHz, or accurate to 0.33 ppm.

Care must be taken when synchronization of isochronous data is not possible, i.e. when the PLL has to be used in the above mode. The I2S should be master on the LM49321 so that the data source can support appropriate SRC as required. This method should only be used with data being read on demand to eliminate sample rate mismatch problems.

Where a system clock exists at an integer multiple of the required DAC clock rate it is preferable to use this rather than the PLL. The LM49321 is designed to work in 8,12,16,24,32, and 48kHz modes from a 12MHz clock without the use of the PLL. This saves power and reduces clock jitter.

DAC Setup Register

This register is used to configure the basic operation of the stereo DAC.

TABLE 22. DAC_SETUP (0Eh)

Bits	Register	Description			
1:0	DAC_MODE	The DAC used in the LM49321 can operate in one of 4 oversampling modes. The modes are described as follows:			
		DAC_MODE	Oversampling Rate	Typical f_s	MCLK Required
		00	125	48KHz	12.000MHz (USB Mode)
		01	128	44.1KHz 48KHz	11.2896MHz 12.288MHz
		10	64	96KHz	12.288MHz
		11	32	192KHz	24.576MHz
2	MUTE_L	Mutes the left DAC channel on the next zero crossing.			
3	MUTE_R	Mutes the right DAC channel on the next zero crossing.			
4	DITHER_OFF	If set the dither in DAC is disabled.			
5	DITHER_ALWAYS_ON	If set the dither in DAC is enabled all the time.			
6	CUST_COMP	If set the DAC frequency response can be programmed manually via a 5 tap FIR "compensation" filter. This can be used to enhance the frequency response of small loudspeakers or provide a crude tone control. The compensation Coefficients can be set by using registers 10h to 15h.			

Interface Control Register

This register is used to control the I²S and I²C compatible interface on the chip.

TABLE 23. INTERFACE (0Fh)

Bits	Field	Description	
0	I ² S_MASTER_SLAVE	This enables I ² S in master or slave mode.	
		I ² S_MASTER_SLAVE	Comments
		0	LM49321 acts as a slave where both I ² S clock and word select are configured as inputs.
		1	LM49321 acts as a master for I ² S, so both I ² S clock and I ² S word select are configured as outputs.
1	I ² S_RESOLUTION	This set the I ² S resolution and affects the I ² S Interface in master mode. In slave mode the I ² S Interface can support any I ² S compatible resolution. In master mode the I ² S resolution also depends on the DAC mode as the note below explains.	
		I ² S_RESOLUTION	Comments
		0	I ² S resolution is set to 16 bits.
		1	I ² S resolution is set to 32 bits.
2	I ² S_MODE	This set the I ² S mode timing.	
		I ² S_MODE	Comments
		0	I ² S interface is configured in normal I ² S mode timing.
		1	I ² S is configured in left justified mode timing.
3	I ² C_FAST	This set the I ² C Clock speed.	
		I ² C_FAST	Comments
		0	I ² C speed gets its default value of a maximum of 400kHz.
		1	This enables the I ² C to run in fast mode with an I ² C clock up to 3.4MHz.

NOTES:

The master I²S format depends on the DAC mode. In USB mode the number of bits per word is 25 (i.e. 2.4MHz for a 48kHz sample rate). The duty cycle is 40/60. In non-USB modes the format is 32 or 16 bits per word, depending on I²S_RESOLUTION and the duty cycle is always 50-50. In slave mode it will decode any I²S compatible data stream.

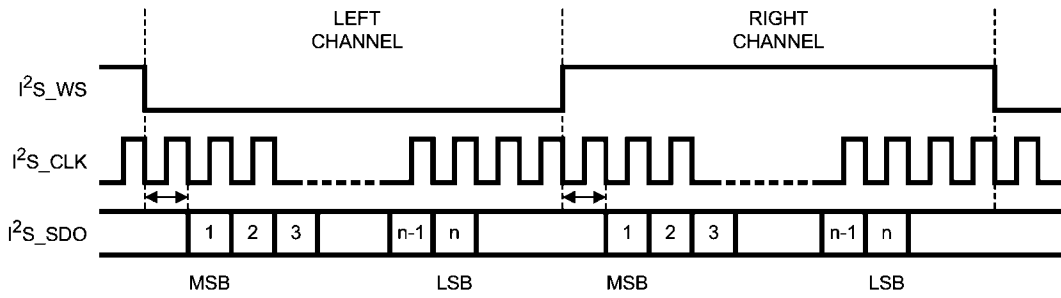

30061827

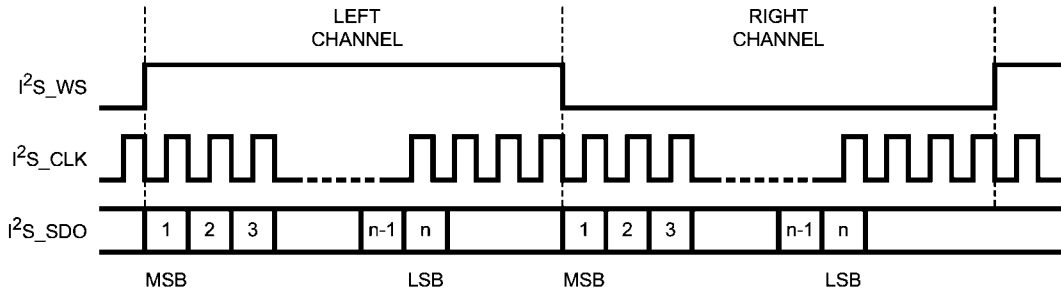
I2S Mode Timing

30061828

Left Justified Mode Timing

FIR Compensation Filter Configuration Registers

must be programmed via the I2C/SPI Interface in bytes as follows:

These registers are used to configure the DAC's FIR compensation filter. Three 16 bit coefficients are required and

TABLE 24. COMP_COEFF (10h → 15h)

Address	Register	Description
10h	COMP_COEFF0_LSB	Bits [7:0] of the 1st and 5th FIR tap (C0 and C4)
11h	COMP_COEFF0_MSB	Bits [15:8] of the 1st and 5th FIR tap (C0 and C4)
12h	COMP_COEFF1_LSB	Bits [7:0] of the 2nd and 4th FIR tap (C1 and C3)
13h	COMP_COEFF1_MSB	Bits [15:8] of the 2nd and 4th FIR tap (C1 and C3)
14h	COMP_COEFF2_LSB	Bits [7:0] of the 3rd FIR tap (C2)
15h	COMP_COEFF2_MSB	Bits [15:8] of the 3rd FIR tap (C2)

NOTES:

The filter must be phase linear to ensure the data keeps the correct stereo imaging so the second half of the FIR filter must be the reverse of the 1st half.

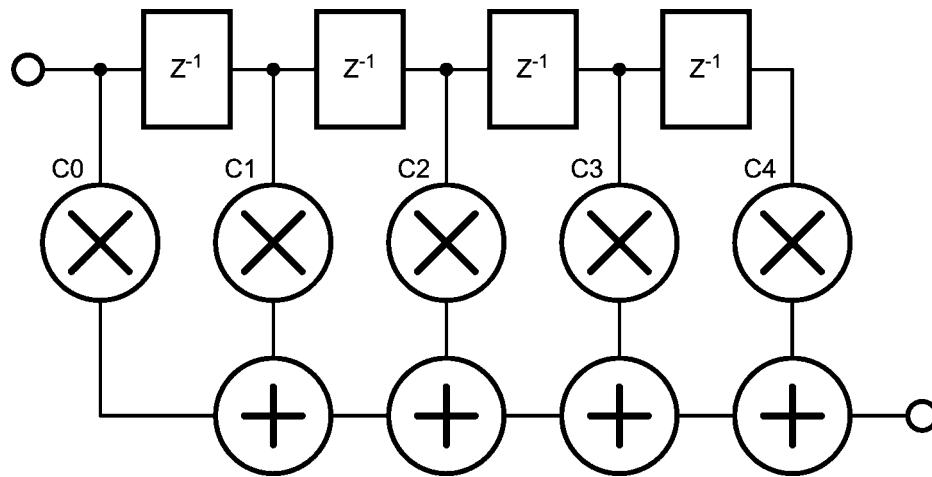

30061855

If the CUST_COMP option in register 0Eh is not set the FIR filter will use its default values for a linear response from the DAC into the analog mixer, these values are:

DAC_OSR	C0, C4	C1, C3	C2
00	434	-2291	26984
01, 10, 11	61	-371	25699

If using 96 or 192kHz data then the custom compensation may be required to obtain flat frequency responses above 24kHz. The total power of any custom filter must not exceed

that of the above examples or the filters within the DAC will clip. The coefficient must be programmed in 2's complement.

Typical Performance Characteristics

THD+N vs Frequency
 $AV_{DD} = 3.0V$, EP Out, $R_L = 32\Omega$, $P_O = 20mW$

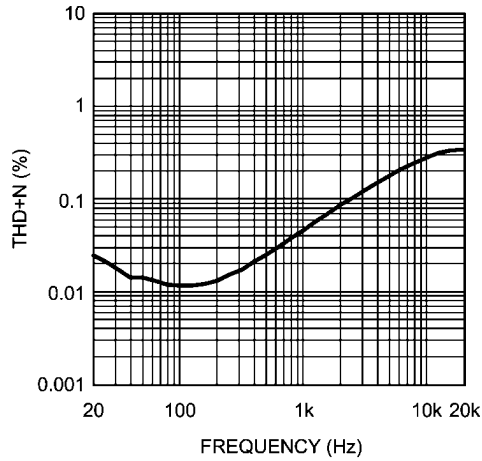

30061864

THD+N vs Frequency
 $AV_{DD} = 3.0V$, HP Out, $R_L = 16\Omega$, $P_O = 20mW$

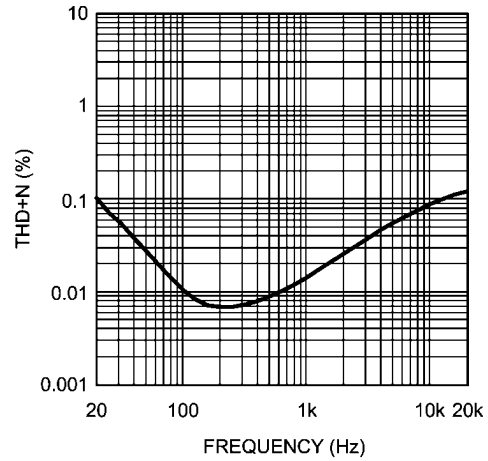

30061865

THD+N vs Frequency
 $AV_{DD} = 3.0V$, LS Out, $R_L = 8\Omega$, $P_O = 200mW$

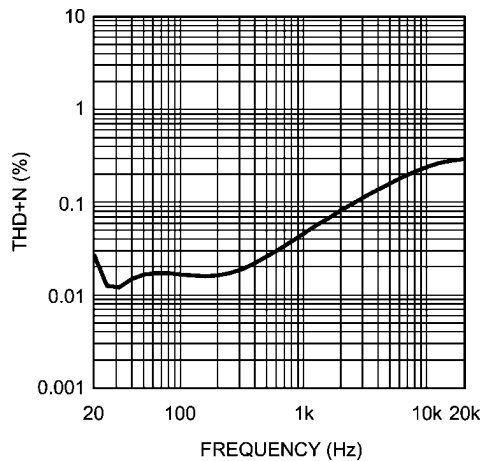

30061866

THD+N vs Frequency
 $AV_{DD} = 5.0V$, EP, $R_L = 32\Omega$, $P_O = 40mW$

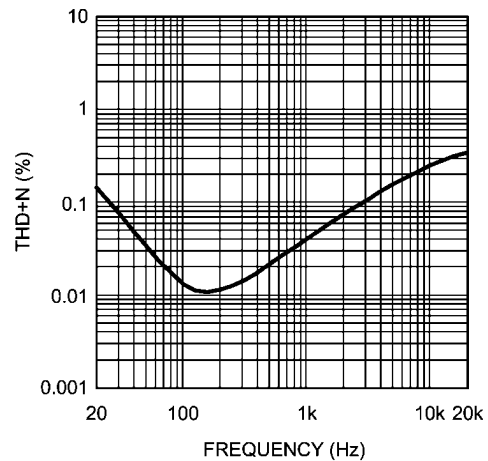

30061867

THD+N vs Frequency
 $AV_{DD} = 5.0V$, HP Out, $R_L = 16\Omega$, $P_O = 60mW$

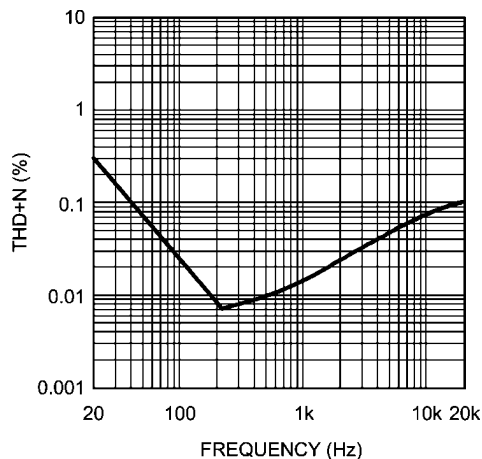

30061869

THD+N vs Frequency
 $AV_{DD} = 5.0V$, HP Out, $R_L = 32\Omega$, $P_O = 30mW$

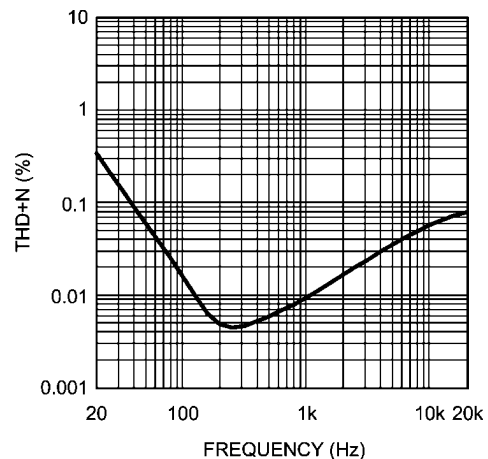

30061870

THD+N vs Frequency
 $AV_{DD} = 5.0V$, LS Out, $R_L = 8\Omega$, $P_O = 500mW$

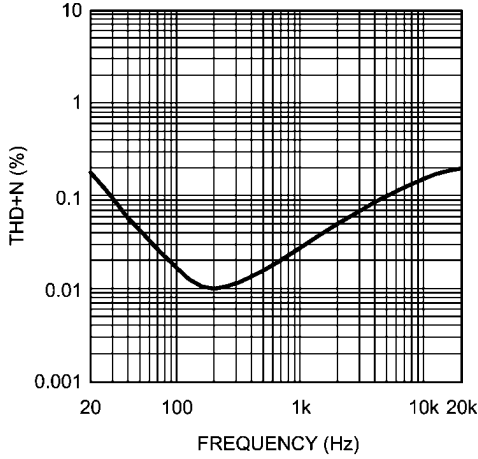

30061871

THD+N vs Output Power
 $AV_{DD} = 3.0V$, EP Out, $R_L = 16\Omega$, $f = 1kHz$

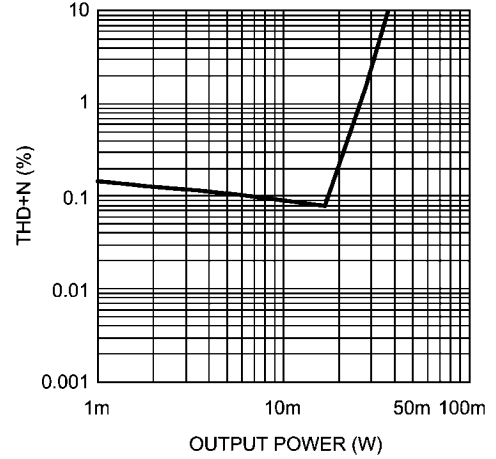

30061872

THD+N vs Output Power
 $AV_{DD} = 3.0V$, EP Out, $R_L = 32\Omega$, $f = 1kHz$

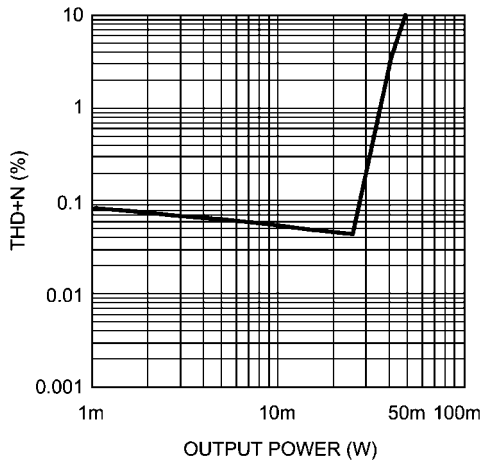

30061873

THD+N vs Output Power
 $AV_{DD} = 3.0V$, HP Out, $R_L = 16\Omega$, $f = 1kHz$

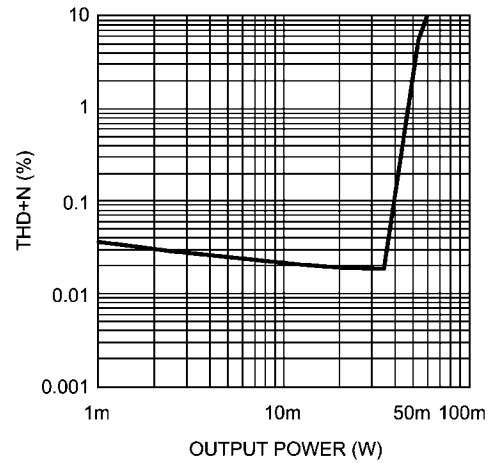

30061876

THD+N vs Output Power
 $AV_{DD} = 3.0V$, HP Out, $R_L = 32\Omega$, $f = 1kHz$

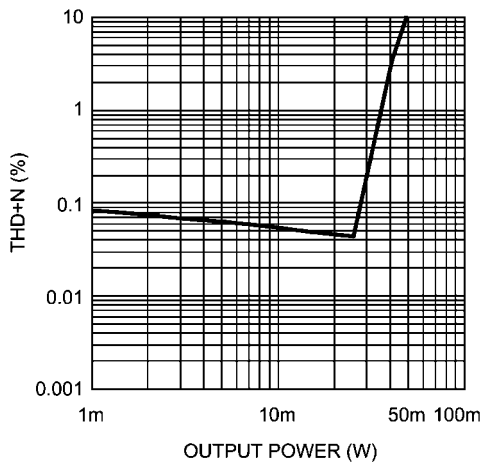

30061877

THD+N vs Output Power
 $AV_{DD} = 3.0V$, LS Out, $R_L = 8\Omega$, $f = 1kHz$

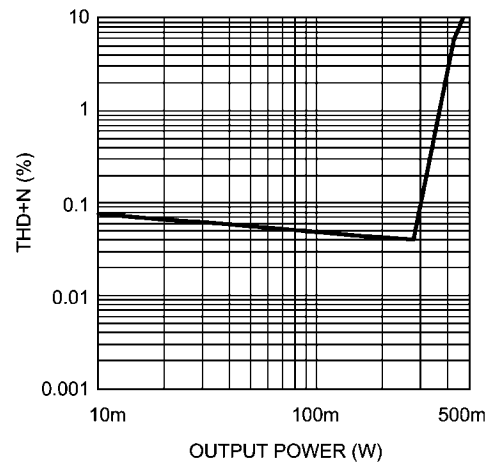

30061819

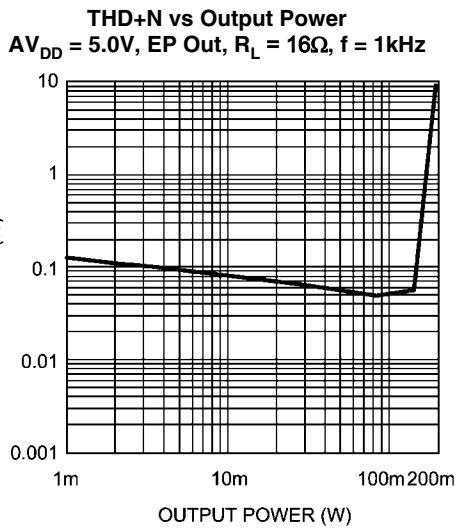

30061878

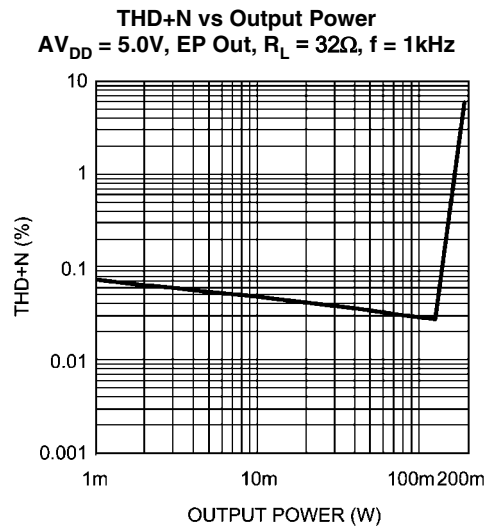

30061879

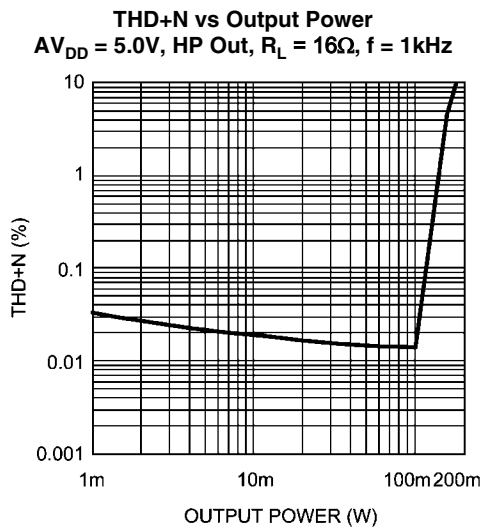

30061880

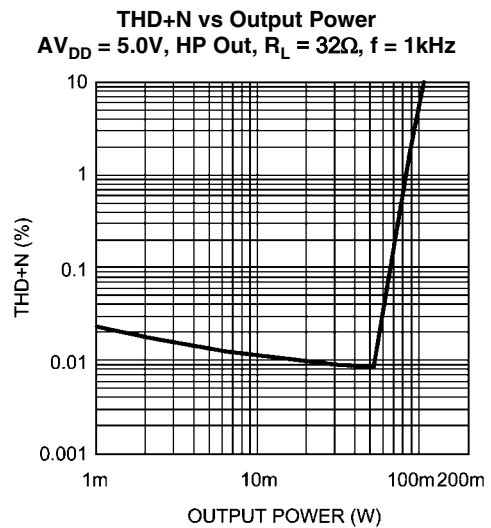

30061881

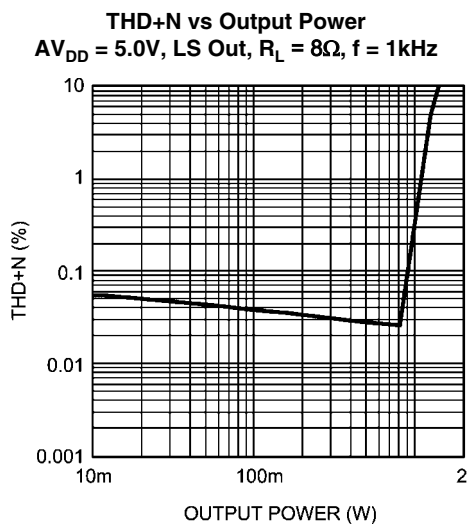

30061882

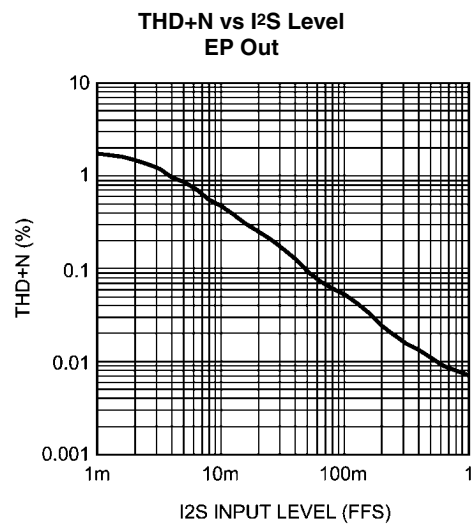

30061883

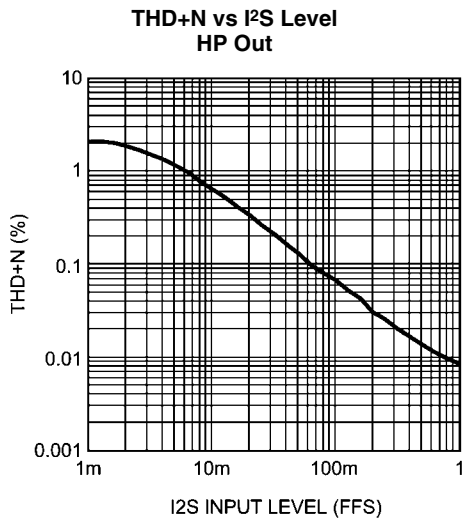

30061884

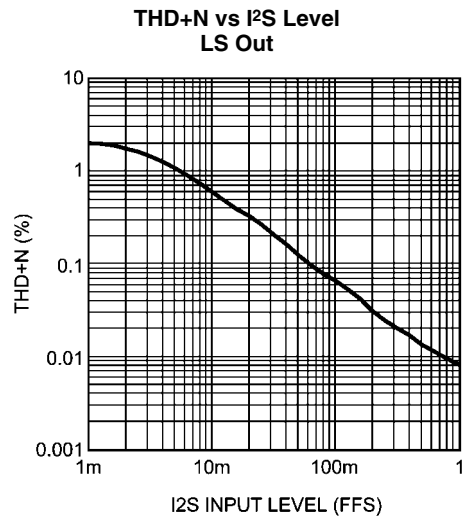

30061885

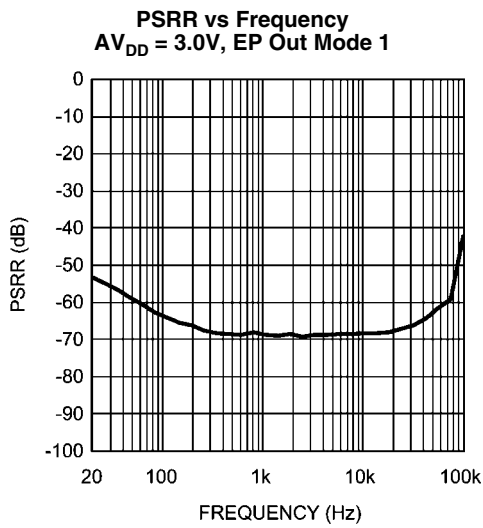

30061886

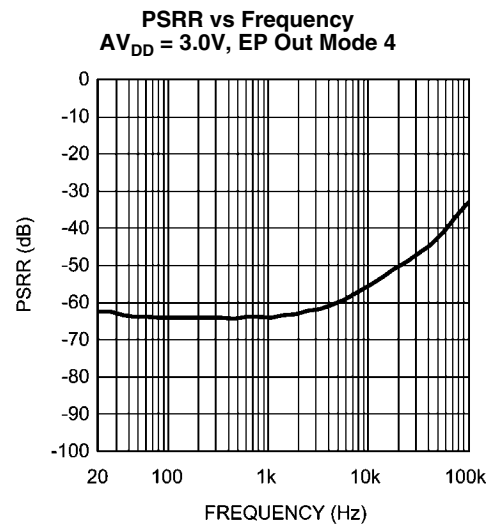

30061887

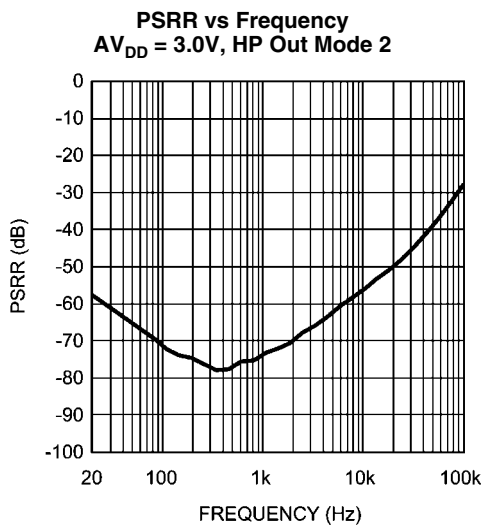

30061888

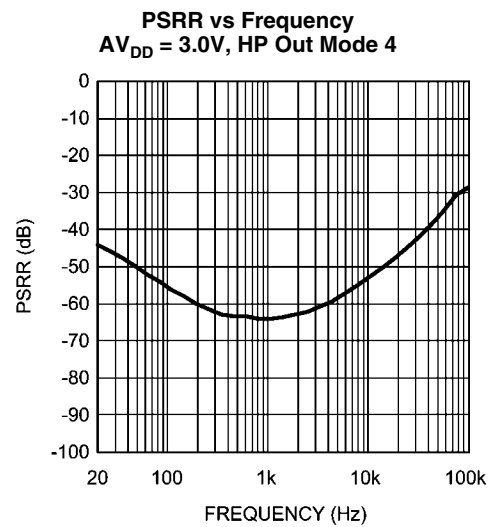

30061889

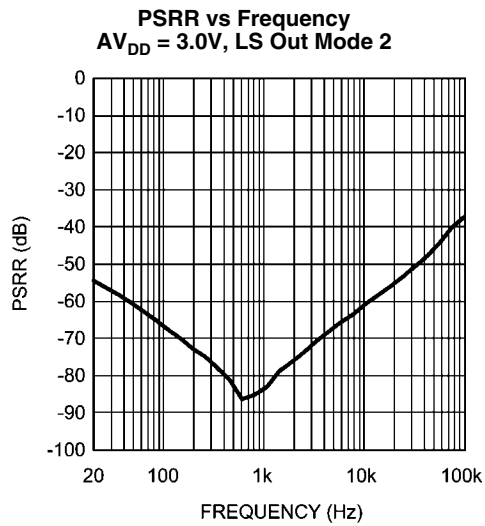

30061890

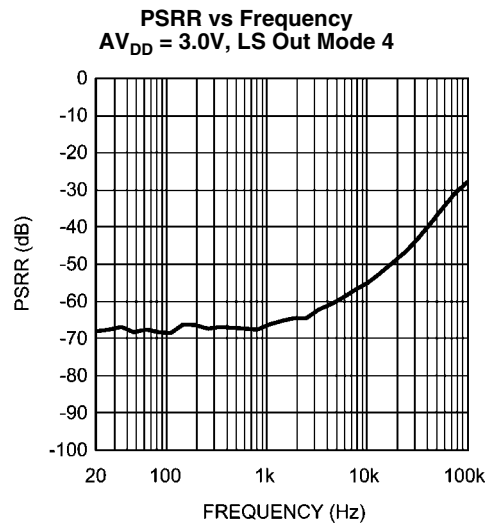

30061891

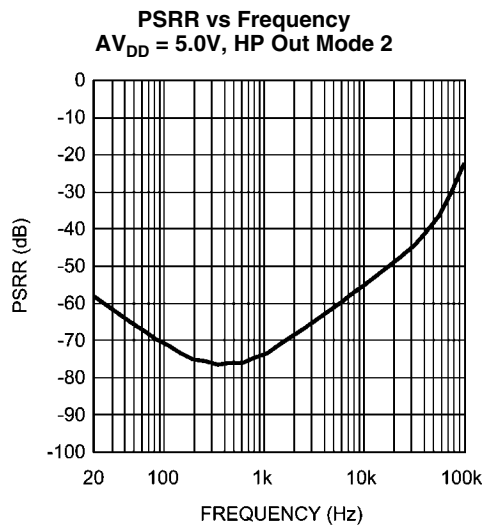

30061892

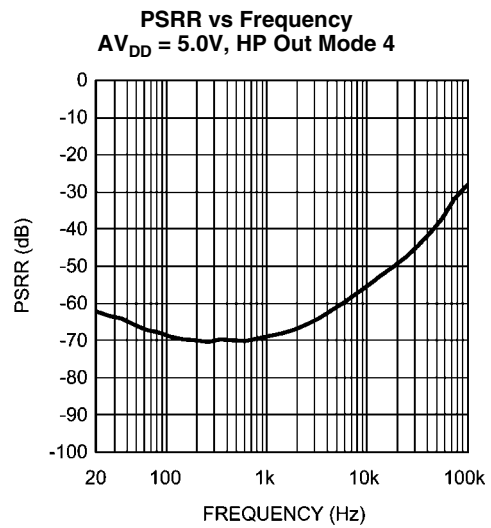

30061893

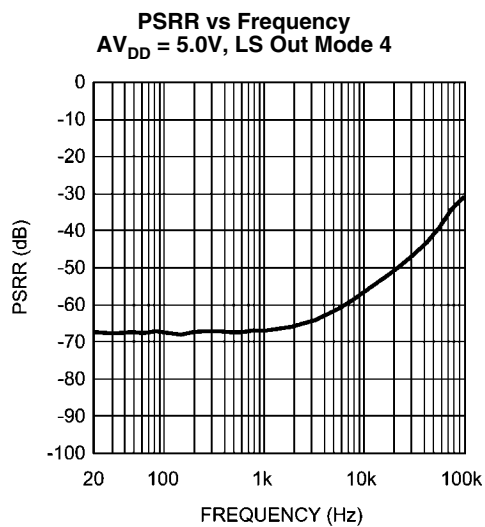

30061894

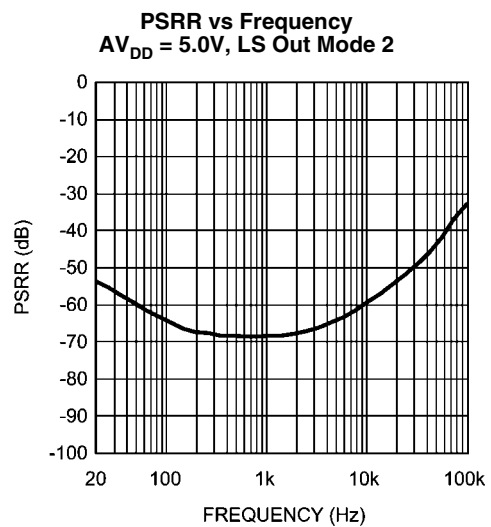

30061895

Output Power vs Supply Voltage
EP Out , $R_L = 32\Omega$, 1% THD+N

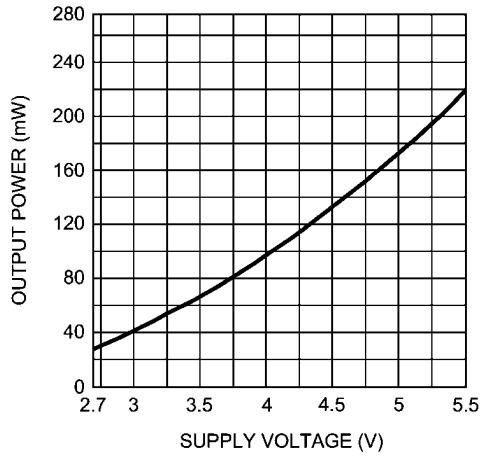

30061896

Output Power vs Supply Voltage
HP Out , $R_L = 32\Omega$, 1% THD+N

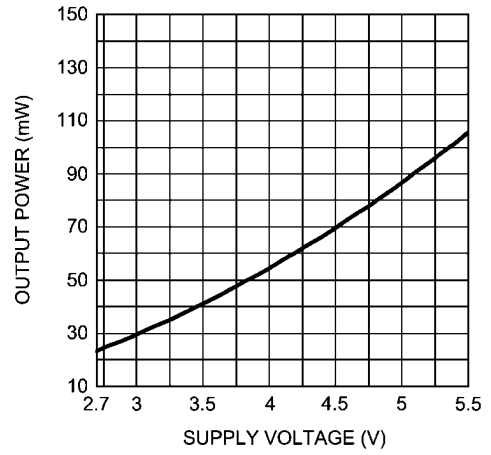

30061897

Output Power vs Supply Voltage
LS Out , $R_L = 8\Omega$, 1% THD+N

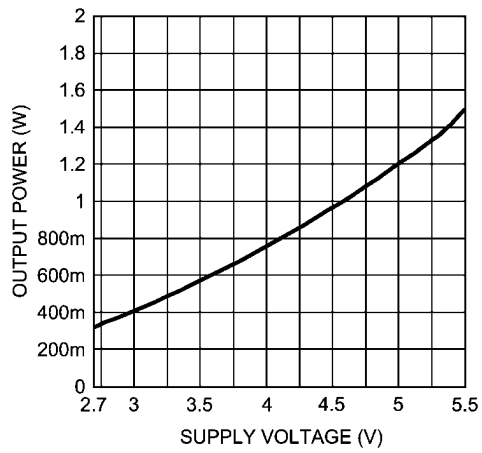

30061898

Application Information

3.072MHz (48kHz stereo, 32bit). The basic format is shown below:

I²S

The LM49321 supports both master and slave I²S transmission at either 16 or 32 bits per word at clock rates up to

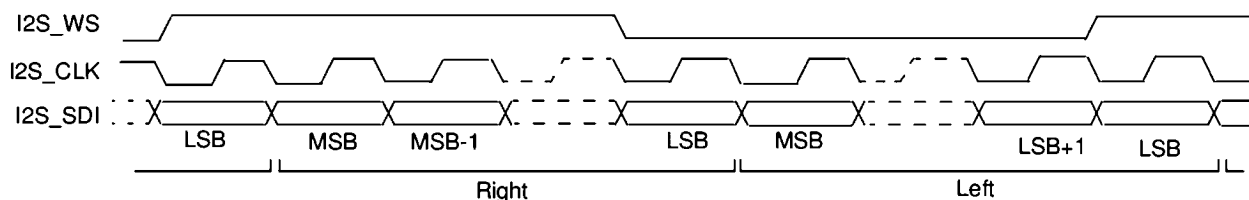

30061807

FIGURE 1.

MONO ONLY SETTING

The LM49321 may be restricted to mono amplification only by setting MONO_ONLY in Output Control register 0x01h to 1. This may save an additional 400 μ A from I_{DD}.

LM49321 DEMOBOARD OPERATION

BOARD LAYOUT

DIGITAL SUPPLIES

JP14 — Digital Power DVDD

JP10 — I/O Power IOVDD

JP13 — PLL Supply PLLVDD

JP16 — USB Board Supply BBVDD

JP15 — I²CVDD

All supplies may be set independently. All digital ground is common. Jumpers may be used to connect all the digital supplies together.

S9 – connects VDD_PLL to VDD_D

S10 – connects VDD_D to VDD_IO

S11 – connects VDD_IO to VDD_I2C

S12 – connects VDD_I2C to Analog VDD

S17 – connects BB_VDD to USB3.3V (from USB board)

S19 – connects VDD_D to USB3.3V (from USB board)

S20 – connects VDD_D to SPDIF receiver chip

ANALOG SUPPLY

JP11 — Analog Supply

S12 — connects Analog VDD with Digital VDD (I²C_VDD)

S16 — connects Analog Ground with Digital Ground

S21 — connects Analog VDD to SPDIF receiver chip

INPUTS

Analog Inputs

JP2 — Mono Differential Input

JP6 — Left Input

JP7 — Right Input

Digital Inputs

JP19 — Digital Interface

Pin 1 — MCLK

Pin 2 — I²S_CLK

Pin 3 — I²S_SDI

Pin 4 — I²S_WS

JP20 — Toslink SPDIF Input

JP21 — Coaxial SPDIF Input

Coaxial and Toslink inputs may be toggled between by use of S25. Only one may be used at a time. Must be used in conjunction with on-board SPDIF receiver chip.

OUTPUTS

JP5 — BTL Loudspeaker Output

JP1 — Left Headphone Output (Single-Ended or OCL)

JP3 — Right Headphone Output (Single-Ended or OCL)

P1 — Stereo Headphone Jack (Same as JP1, JP2, Single-Ended or OCL)

JP12 — Mono BTL Earpiece Output

CONTROL INTERFACE

X1, X2 – USB Control Bus for I²C/SPI

X1

Pin 9 – Mode Select (SPI or I²C)

X2

Pin 1 – SDA

Pin 3 – SCL

Pin 15 – ADDR/END

Pin 14 – USB5V

Pin 16 – USB3.3V

Pin 16 – USB GND

MISCELLANEOUS

I²S BUS SELECT

S23, S24, S26, S27 – I²S Bus select. Toggles between on-board and external I²S (whether on-board SPDIF receiver is used). All jumpers must be set the same. Jumpers on top two pins selects external bus (JP19). Jumpers on bottom two pins selects on-board SPDIF receiver output.

HEADPHONE OUTPUT CONFIGURATION

Jumpers S1, S2, S3, and S4 are used to configure the headphone outputs for either cap-coupled outputs or output capacitorless (OCL) mode in addition to the register control internal to the LM49321 for this feature. Jumpers S1 and S3 bypass the output DC blocking capacitors when OCL mode

is required. S2 connects the center amplifier HPCOUT to the headphone ring when in OCL mode. S4 connects the center ring to GND when cap-coupled mode is desired. S4 must be removed for OCL mode to function properly. Jumper settings for each mode:

OCL

S1 = ON

S2 = ON

S3 = ON

S4 = OFF

Cap-Coupled

S1 = OFF

S2 = OFF

S3 = OFF

S4 = ON

PLL FILTER CONFIGURATION

The LM49321 demo board comes with a simple filter setup by connecting jumpers S5 and S6. Removing these and connecting jumpers S7 and S8 will allow for an alternate PLL filter configuration to be used at R2 and C23.

ON-BOARD SPDIF RECEIVER

The SPDIF receiver present on the LM49321 demo board allows quick demonstration of the capabilities of the LM49321 by using the common SPDIF output found on most CD/DVD players today. There are some limitations in its useage, as the receiver will not work with digital supplies of less than 3.0V and analog supplies of less than 4V. This means low analog

supply voltage testing of the LM49321 must be done on the external digital bus.

The choice of using on-board or external digital bus is made using jumpers S23, S24, S26, and S27 as described above. S25 selects whether the Toslink or Coaxial SPDIF input is used. The top two pins connects the toslink, the bottom two connect the coaxial input.

Power on the digital side is routed through S20 (connecting to the other digital supplies), while on the analog side it is interrupted by S21. Both jumpers must be in place for the receiver to function. The part is already configured for I²S standard outputs. Jumper S28 allows the DATA output to be pulled either high or low. Default is high (jumper on right two pins).

It may be necessary to quickly toggle S29 to reset the receiver and start it working upon initial power up. A quick short across S29 should clear this condition.

LM49321 I²C/SPI INTERFACE SOFTWARE

Convenient graphical user interface software is available for demonstration purposes of the LM49321. It allows for either SPI or I²C control via either USB or parallel port connections to a Windows computer. Control options include all mode and output settings, volume controls, PLL and DAC setup, FIR setting and on-the-fly adjustment by an easy to use graphical interface. An advanced option is also present to allow direct, register-level commands. Software is available from www.national.com and is compatible with Windows operating systems of Windows 98 or more (with USB support) with the latest .NET updates from Microsoft.

Demonstration Board Schematic

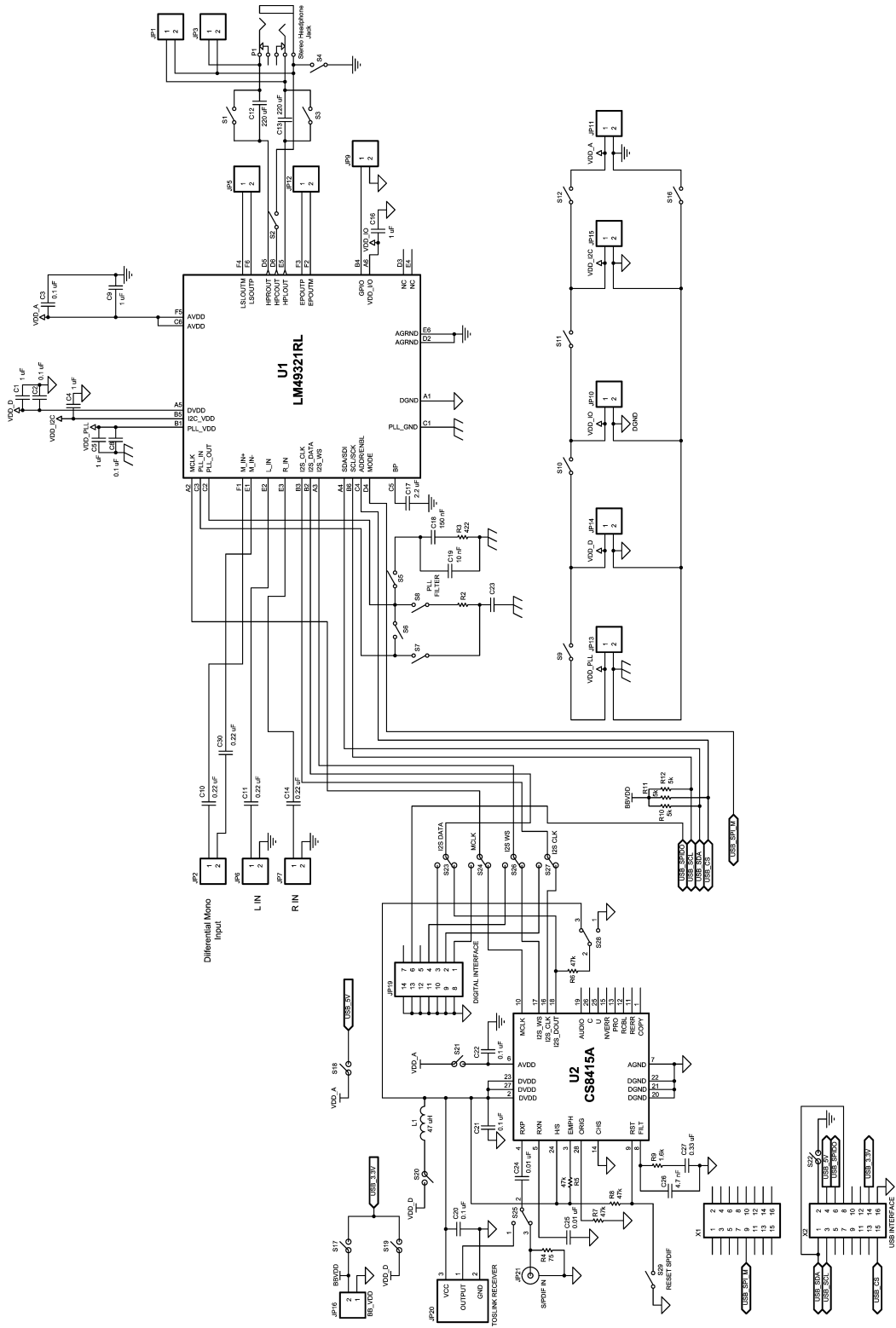

30061803

Complete Board Schematic

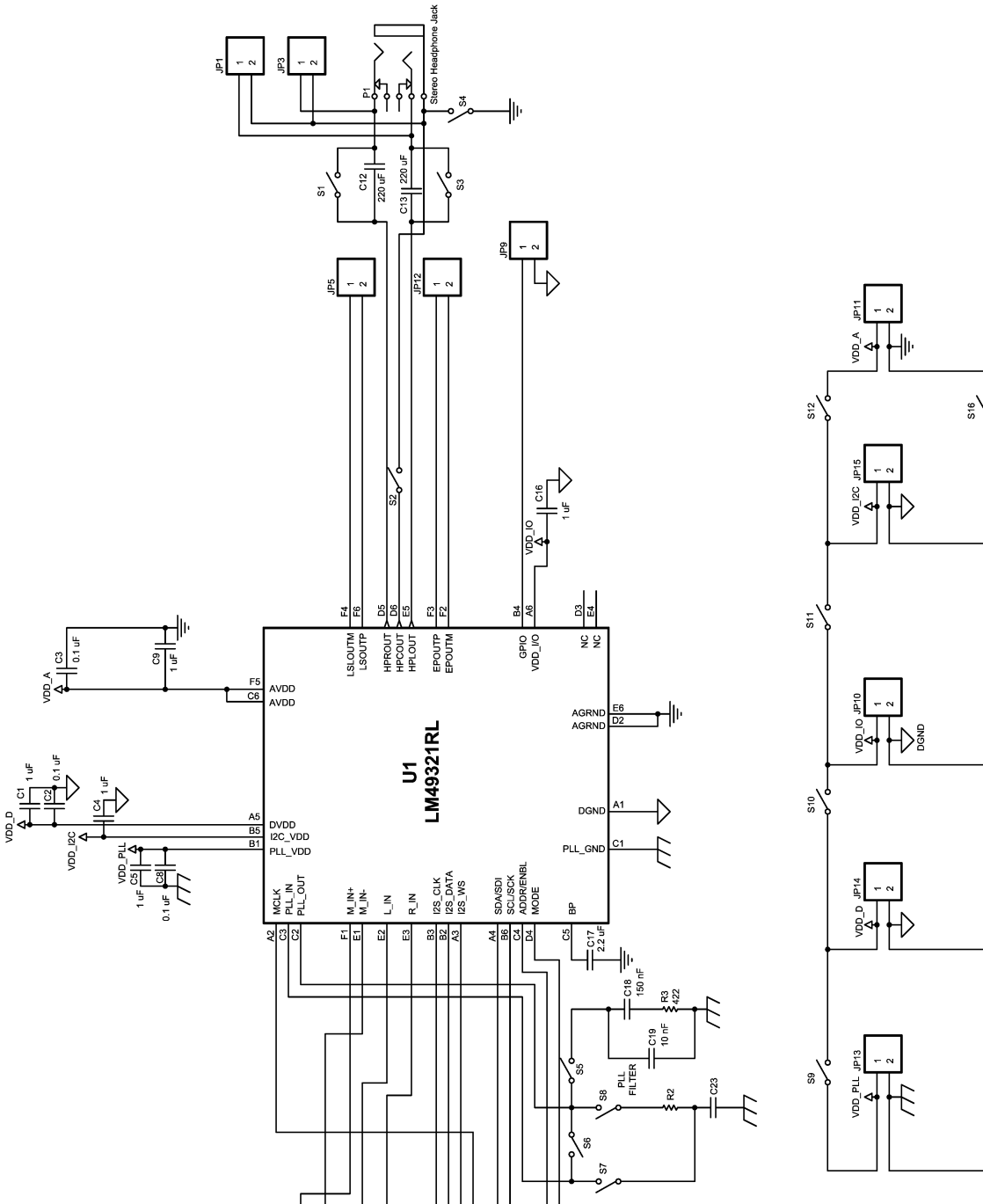

300618x7

Enlarged Board Schematic Part 2 of 2

Revision History

Rev	Date	Description
1.0	09/10/08	Initial release.
1.01	09/23/08	Text edits.
1.02	08/31/09	Edited the package drawing and the top markings.

Physical Dimensions inches (millimeters) unless otherwise noted

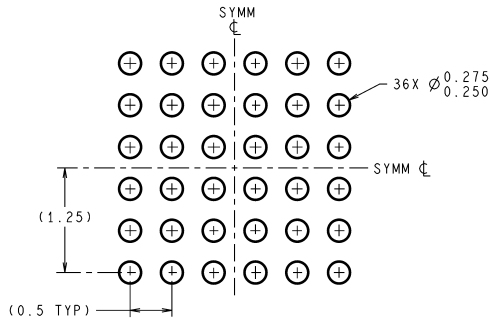

DIMENSIONS ARE IN MILLIMETERS
DIMENSIONS IN () FOR REFERENCE ONLY

LAND PATTERN RECOMMENDATION

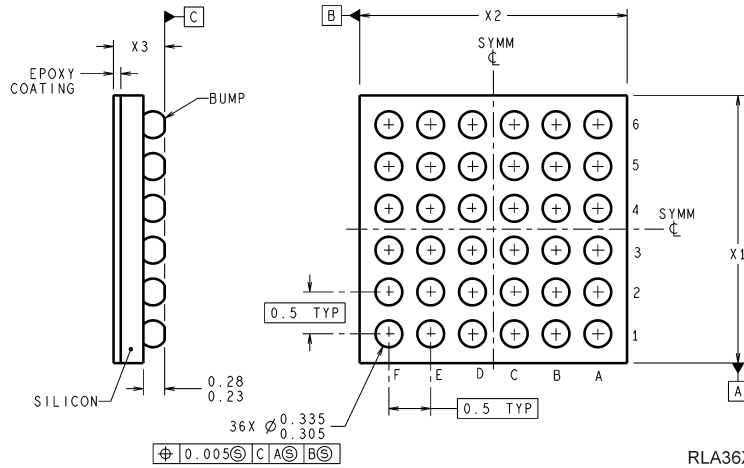
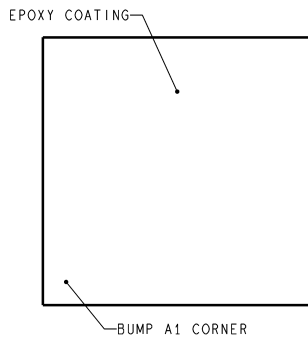

RLA36XXX (Rev A)

36-Bump micro SMD
Order Number LM49321RL
NS Package Number RLA36LVA
 $X_1 = 3255 \pm 30 \mu\text{m}$, $X_2 = 3510 \pm 30 \mu\text{m}$, $X_3 = 650 \pm 75 \mu\text{m}$

Notes

For more National Semiconductor product information and proven design tools, visit the following Web sites at:

Products		Design Support	
Amplifiers	www.national.com/amplifiers	WEBENCH® Tools	www.national.com/webench
Audio	www.national.com/audio	App Notes	www.national.com/appnotes
Clock and Timing	www.national.com/timing	Reference Designs	www.national.com/refdesigns
Data Converters	www.national.com/adc	Samples	www.national.com/samples
Interface	www.national.com/interface	Eval Boards	www.national.com/evalboards
LVDS	www.national.com/lvds	Packaging	www.national.com/packaging
Power Management	www.national.com/power	Green Compliance	www.national.com/quality/green
Switching Regulators	www.national.com/switchers	Distributors	www.national.com/contacts
LDOs	www.national.com/ldo	Quality and Reliability	www.national.com/quality
LED Lighting	www.national.com/led	Feedback/Support	www.national.com/feedback
Voltage Reference	www.national.com/vref	Design Made Easy	www.national.com/easy
PowerWise® Solutions	www.national.com/powerwise	Solutions	www.national.com/solutions
Serial Digital Interface (SDI)	www.national.com/sdi	Mil/Aero	www.national.com/milaero
Temperature Sensors	www.national.com/tempensors	SolarMagic™	www.national.com/solarmagic
Wireless (PLL/VCO)	www.national.com/wireless	PowerWise® Design University	www.national.com/training

THE CONTENTS OF THIS DOCUMENT ARE PROVIDED IN CONNECTION WITH NATIONAL SEMICONDUCTOR CORPORATION ("NATIONAL") PRODUCTS. NATIONAL MAKES NO REPRESENTATIONS OR WARRANTIES WITH RESPECT TO THE ACCURACY OR COMPLETENESS OF THE CONTENTS OF THIS PUBLICATION AND RESERVES THE RIGHT TO MAKE CHANGES TO SPECIFICATIONS AND PRODUCT DESCRIPTIONS AT ANY TIME WITHOUT NOTICE. NO LICENSE, WHETHER EXPRESS, IMPLIED, ARISING BY ESTOPPEL OR OTHERWISE, TO ANY INTELLECTUAL PROPERTY RIGHTS IS GRANTED BY THIS DOCUMENT.

TESTING AND OTHER QUALITY CONTROLS ARE USED TO THE EXTENT NATIONAL DEEMS NECESSARY TO SUPPORT NATIONAL'S PRODUCT WARRANTY. EXCEPT WHERE MANDATED BY GOVERNMENT REQUIREMENTS, TESTING OF ALL PARAMETERS OF EACH PRODUCT IS NOT NECESSARILY PERFORMED. NATIONAL ASSUMES NO LIABILITY FOR APPLICATIONS ASSISTANCE OR BUYER PRODUCT DESIGN. BUYERS ARE RESPONSIBLE FOR THEIR PRODUCTS AND APPLICATIONS USING NATIONAL COMPONENTS. PRIOR TO USING OR DISTRIBUTING ANY PRODUCTS THAT INCLUDE NATIONAL COMPONENTS, BUYERS SHOULD PROVIDE ADEQUATE DESIGN, TESTING AND OPERATING SAFEGUARDS.

EXCEPT AS PROVIDED IN NATIONAL'S TERMS AND CONDITIONS OF SALE FOR SUCH PRODUCTS, NATIONAL ASSUMES NO LIABILITY WHATSOEVER, AND NATIONAL DISCLAIMS ANY EXPRESS OR IMPLIED WARRANTY RELATING TO THE SALE AND/OR USE OF NATIONAL PRODUCTS INCLUDING LIABILITY OR WARRANTIES RELATING TO FITNESS FOR A PARTICULAR PURPOSE, MERCHANTABILITY, OR INFRINGEMENT OF ANY PATENT, COPYRIGHT OR OTHER INTELLECTUAL PROPERTY RIGHT.

LIFE SUPPORT POLICY

NATIONAL'S PRODUCTS ARE NOT AUTHORIZED FOR USE AS CRITICAL COMPONENTS IN LIFE SUPPORT DEVICES OR SYSTEMS WITHOUT THE EXPRESS PRIOR WRITTEN APPROVAL OF THE CHIEF EXECUTIVE OFFICER AND GENERAL COUNSEL OF NATIONAL SEMICONDUCTOR CORPORATION. As used herein:

Life support devices or systems are devices which (a) are intended for surgical implant into the body, or (b) support or sustain life and whose failure to perform when properly used in accordance with instructions for use provided in the labeling can be reasonably expected to result in a significant injury to the user. A critical component is any component in a life support device or system whose failure to perform can be reasonably expected to cause the failure of the life support device or system or to affect its safety or effectiveness.

National Semiconductor and the National Semiconductor logo are registered trademarks of National Semiconductor Corporation. All other brand or product names may be trademarks or registered trademarks of their respective holders.

Copyright© 2009 National Semiconductor Corporation

For the most current product information visit us at www.national.com



National Semiconductor Americas Technical Support Center
Email: support@nsc.com
Tel: 1-800-272-9959

National Semiconductor Europe Technical Support Center
Email: europe.support@nsc.com

National Semiconductor Asia Pacific Technical Support Center
Email: ap.support@nsc.com

National Semiconductor Japan Technical Support Center
Email: jpn.feedback@nsc.com