



# RF Power LDMOS Transistor

## N-Channel Enhancement-Mode Lateral MOSFET

This 45 watt RF power LDMOS transistor is designed for cellular base station applications covering the frequency range of 2300 to 2400 MHz.

- Typical Single-Carrier W-CDMA Performance:  $V_{DD} = 28$  Volts,  $I_{DQ} = 1100$  mA,  $P_{out} = 45$  Watts Avg., Input Signal PAR = 9.9 dB @ 0.01% Probability on CCDF.

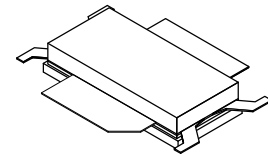
Frequency	$G_{ps}$ (dB)	$\eta_D$ (%)	Output PAR (dB)	ACPR (dBc)	IRL (dB)
2300 MHz	18.3	33.8	6.9	-34.4	-13
2350 MHz	18.6	33.8	6.9	-34.3	-16
2400 MHz	18.8	33.9	6.8	-33.9	-13

### Features

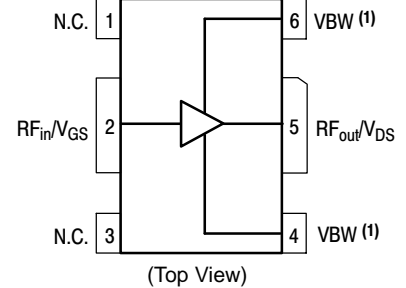
- Greater Negative Gate-Source Voltage Range for Improved Class C Operation
- Designed for Digital Predistortion Error Correction Systems
- Optimized for Doherty Applications
- In Tape and Reel. R3 Suffix = 250 Units, 44 mm Tape Width, 13-inch Reel.

**AFT23S170-13SR3**

**2300-2400 MHz, 45 W AVG., 28 V**



**NI-780S-2L4S**



**Figure 1. Pin Connections**

1. Device can operate with the  $V_{DD}$  current supplied through pin 4 and pin 6 at a reduced RF output power level. Refer to CW operation data in the Maximum Ratings table.

**Table 1. Maximum Ratings**

Rating	Symbol	Value	Unit
Drain–Source Voltage	$V_{DS}$	–0.5, +65	Vdc
Gate–Source Voltage	$V_{GS}$	–6.0, +10	Vdc
Operating Voltage	$V_{DD}$	32, +0	Vdc
Storage Temperature Range	$T_{stg}$	–65 to +150	°C
Case Operating Temperature Range	$T_C$	–40 to +150	°C
Operating Junction Temperature Range (1,2)	$T_J$	–40 to +225	°C
CW Operation @ $T_C = 25^\circ\text{C}$ when DC current is fed through pin 4 and pin 6 Derate above $25^\circ\text{C}$	CW	94 0.44	W W/°C

**Table 2. Thermal Characteristics**

Characteristic	Symbol	Value (2,3)	Unit
Thermal Resistance, Junction to Case Case Temperature $78^\circ\text{C}$ , 45 W CW, 28 Vdc, $I_{DQ} = 1100\text{ mA}$ , 2350 MHz	$R_{\theta JC}$	0.42	°C/W

**Table 3. ESD Protection Characteristics**

Test Methodology	Class
Human Body Model (per JESD22–A114)	2
Machine Model (per EIA/JESD22–A115)	B
Charge Device Model (per JESD22–C101)	IV

**Table 4. Electrical Characteristics** ( $T_A = 25^\circ\text{C}$  unless otherwise noted)

Characteristic	Symbol	Min	Typ	Max	Unit
----------------	--------	-----	-----	-----	------

**Off Characteristics**

Zero Gate Voltage Drain Leakage Current ( $V_{DS} = 65\text{ Vdc}$ , $V_{GS} = 0\text{ Vdc}$ )	$I_{DSS}$	—	—	10	$\mu\text{Adc}$
Zero Gate Voltage Drain Leakage Current ( $V_{DS} = 28\text{ Vdc}$ , $V_{GS} = 0\text{ Vdc}$ )	$I_{DSS}$	—	—	1	$\mu\text{Adc}$
Gate–Source Leakage Current ( $V_{GS} = 5\text{ Vdc}$ , $V_{DS} = 0\text{ Vdc}$ )	$I_{GSS}$	—	—	1	$\mu\text{Adc}$

**On Characteristics**

Gate Threshold Voltage ( $V_{DS} = 10\text{ Vdc}$ , $I_D = 219\ \mu\text{Adc}$ )	$V_{GS(th)}$	0.9	1.3	1.7	Vdc
Gate Quiescent Voltage ( $V_{DD} = 28\text{ Vdc}$ , $I_D = 1100\text{ mAdc}$ , Measured in Functional Test)	$V_{GS(Q)}$	1.4	1.8	2.2	Vdc
Drain–Source On–Voltage ( $V_{GS} = 6\text{ Vdc}$ , $I_D = 2.19\text{ Adc}$ )	$V_{DS(on)}$	0.1	0.2	0.3	Vdc

**Functional Tests (4)** (In Freescale Test Fixture, 50 ohm system)  $V_{DD} = 28\text{ Vdc}$ ,  $I_{DQ} = 1100\text{ mA}$ ,  $P_{out} = 45\text{ W Avg.}$ ,  $f = 2400\text{ MHz}$ , Single–Carrier W–CDMA, IQ Magnitude Clipping, Input Signal PAR = 9.9 dB @ 0.01% Probability on CCDF. ACPR measured in 3.84 MHz Channel Bandwidth @  $\pm 5\text{ MHz}$  Offset.

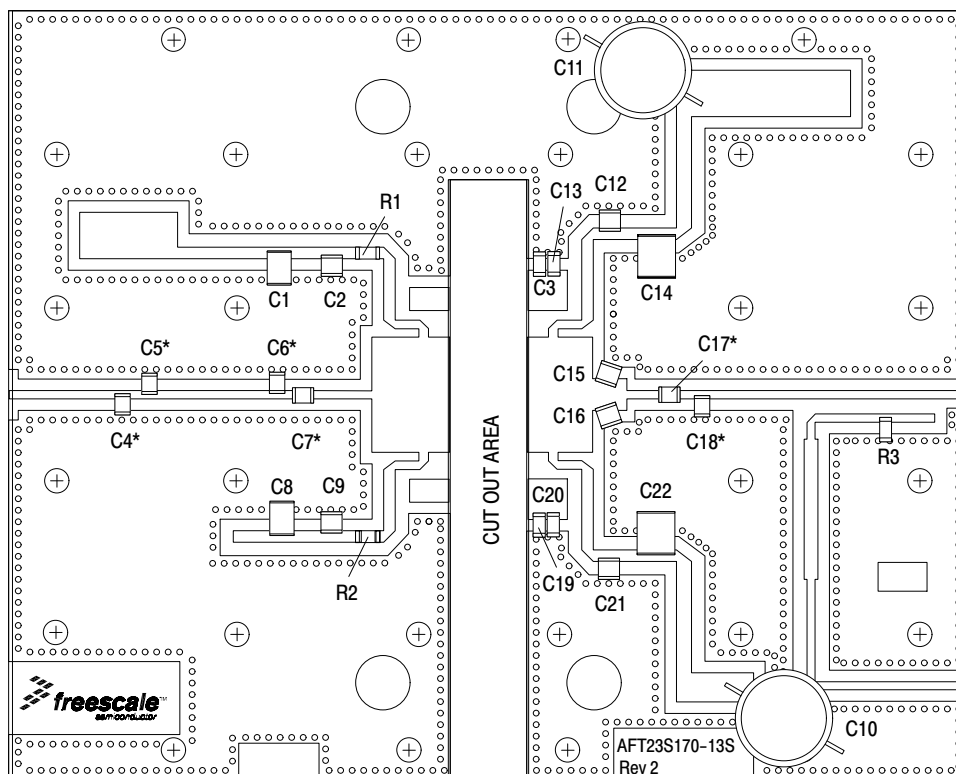
Power Gain	$G_{ps}$	17.5	18.8	20.0	dB
Drain Efficiency	$\eta_D$	32.0	33.9	—	%
Output Peak–to–Average Ratio @ 0.01% Probability on CCDF	PAR	6.3	6.8	—	dB
Adjacent Channel Power Ratio	ACPR	—	–33.9	–32.0	dBc
Input Return Loss	IRL	—	–13	–9	dB

1. Continuous use at maximum temperature will affect MTTF.
2. MTTF calculator available at <http://www.freescale.com/rf>. Select Software & Tools/Development Tools/Calculators to access MTTF calculators by product.
3. Refer to AN1955, *Thermal Measurement Methodology of RF Power Amplifiers*. Go to <http://www.freescale.com/rf>. Select Documentation/Application Notes – AN1955.
4. Part internally matched both on input and output.

(continued)

**Table 4. Electrical Characteristics** ( $T_A = 25^\circ\text{C}$  unless otherwise noted) (continued)

Characteristic	Symbol	Min	Typ	Max	Unit
<b>Load Mismatch</b> (In Freescale Test Fixture, 50 ohm system) $I_{DQ} = 1100\text{ mA}$ , $f = 2350\text{ MHz}$					
VSWR 10:1 at 32 Vdc, 230 W CW Output Power (3 dB Input Overdrive from 178 W CW Rated Power)	No Device Degradation				
<b>Typical Performance</b> (In Freescale Test Fixture, 50 ohm system) $V_{DD} = 28\text{ Vdc}$ , $I_{DQ} = 1100\text{ mA}$ , 2300–2400 MHz Bandwidth					
$P_{out}$ @ 1 dB Compression Point, CW	P1dB	—	147	—	W
AM/PM (Maximum value measured at the P3dB compression point across the 2300–2400 MHz bandwidth)	$\Phi$	—	-14.3	—	°
VBW Resonance Point (IMD Third Order Intermodulation Inflection Point)	VBW <sub>res</sub>	—	95	—	MHz
Gain Flatness in 100 MHz Bandwidth @ $P_{out} = 45\text{ W Avg.}$	$G_F$	—	0.5	—	dB
Gain Variation over Temperature (-30°C to +85°C)	$\Delta G$	—	0.015	—	dB/°C
Output Power Variation over Temperature (-30°C to +85°C)	$\Delta P1dB$	—	0.006	—	dB/°C



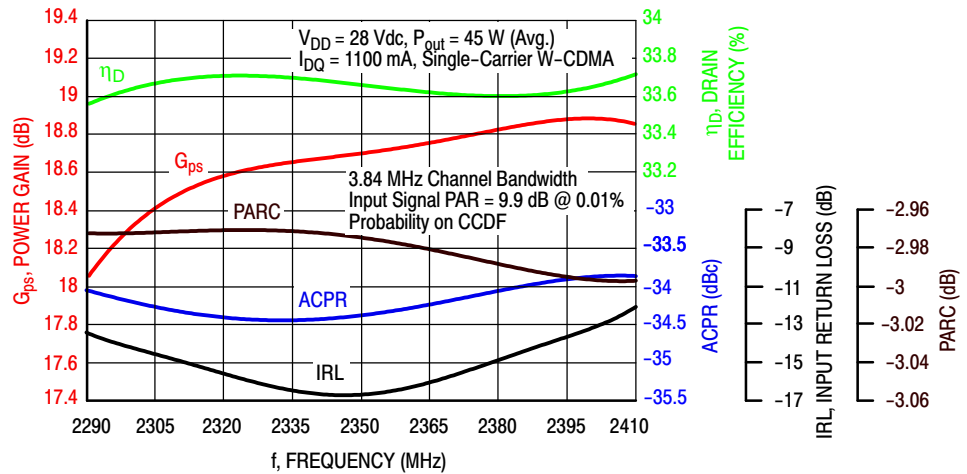
\*C4, C5, C6, C7, C17 and C18 are mounted vertically.

Figure 2. AFT23S170-13SR3 Test Circuit Component Layout

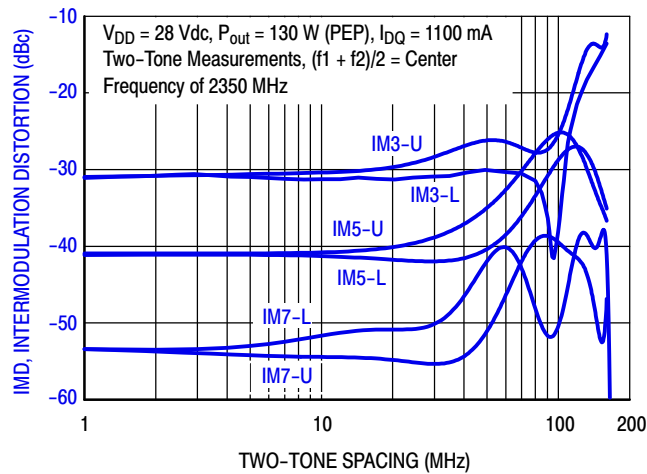
Table 5. AFT23S170-13SR3 Test Circuit Component Designations and Values

Part	Description	Part Number	Manufacturer
C1, C8	2.2 $\mu$ F, 100 V Chip Capacitors	C3225X7R1H225KT	TDK
C2, C7, C9, C12, C17, C21	4.7 pF Chip Capacitors	ATC100B4R7BT500XT	ATC
C3, C13, C19, C20	1000 nF Chip Capacitors	12065G105AT2A	AVX
C4, C5, C18	0.3 pF Chip Capacitors	ATC100B0R3BT500XT	ATC
C6	1.0 pF Chip Capacitor	ATC100B1R0BT500XT	ATC
C10, C11	470 $\mu$ F Electrolytic Capacitors	B41858C8477M000	EPCOS
C14, C22	10 $\mu$ F, 100 V Chip Capacitors	C5750X7S2A106KT	TDK
C15, C16	0.2 pF Chip Capacitors	ATC100B0R2BT500XT	ATC
R1, R2	4.7 $\Omega$ , 1/4 W Chip Resistors	WCR1206-4R7FI	Welwyn
R3	0 $\Omega$ , 2 A Chip Resistor	WCR1206-R005J	Welwyn
PCB	0.020", $\epsilon_r = 3.5$	RO4350B	Rogers

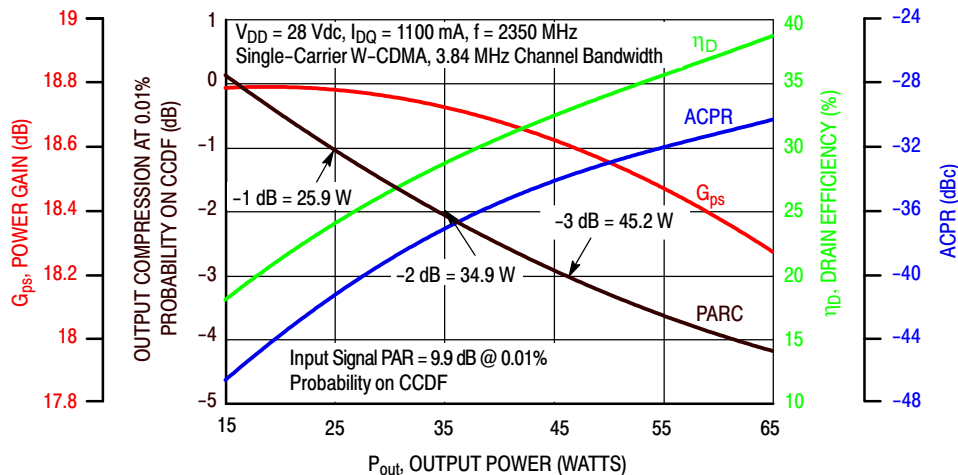
## TYPICAL CHARACTERISTICS



**Figure 3. Single-Carrier Output Peak-to-Average Ratio Compression (PARC) Broadband Performance @  $P_{out} = 45$  Watts Avg.**

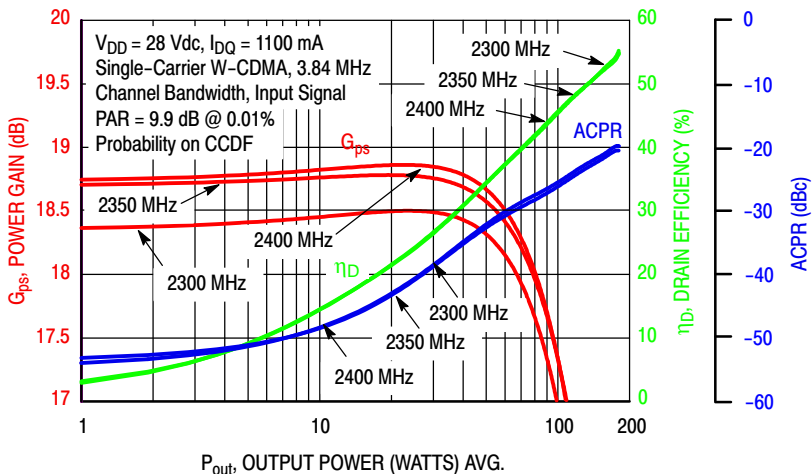


**Figure 4. Intermodulation Distortion Products versus Two-Tone Spacing**

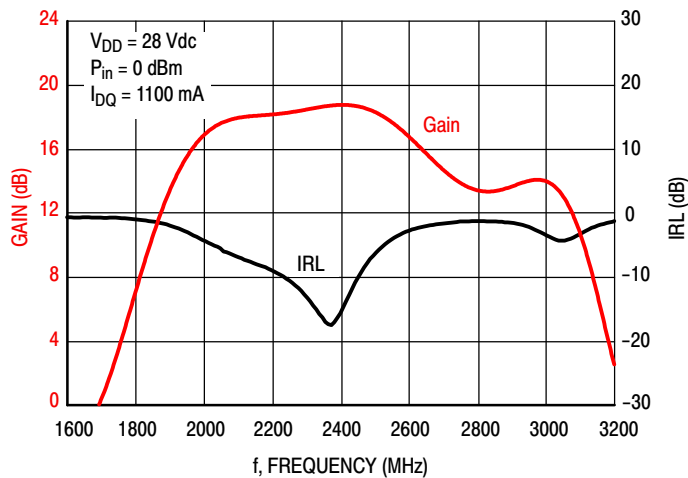


**Figure 5. Output Peak-to-Average Ratio Compression (PARC) versus Output Power**

### TYPICAL CHARACTERISTICS



**Figure 6. Single-Carrier W-CDMA Power Gain, Drain Efficiency and ACPR versus Output Power**



**Figure 7. Broadband Frequency Response**

$V_{DD} = 28 \text{ Vdc}$ ,  $I_{DQ} = 1161 \text{ mA}$ , Pulsed CW, 10  $\mu\text{sec}$ (on), 10% Duty Cycle

f (MHz)	$Z_{\text{source}} (\Omega)$	$Z_{\text{in}} (\Omega)$	Max Output Power					
			P1dB					
			$Z_{\text{load}}^{(1)} (\Omega)$	Gain (dB)	(dBm)	(W)	$\eta_D$ (%)	AM/PM (°)
2300	3.46 – j9.07	3.45 + j8.51	2.09 – j4.35	18.2	53.2	210	51.5	–11
2350	5.27 – j10.0	4.90 + j8.90	2.11 – j4.50	18.0	53.3	213	51.8	–11
2400	8.84 – j10.7	7.40 + j10.2	2.06 – j4.47	18.5	53.2	211	52.4	–12

f (MHz)	$Z_{\text{source}} (\Omega)$	$Z_{\text{in}} (\Omega)$	Max Output Power					
			P3dB					
			$Z_{\text{load}}^{(2)} (\Omega)$	Gain (dB)	(dBm)	(W)	$\eta_D$ (%)	AM/PM (°)
2300	3.46 – j9.07	3.53 + j8.93	2.09 – j4.54	16.0	54.2	260	54.3	–16
2350	5.27 – j10.0	5.22 + j9.48	2.15 – j4.69	15.9	54.2	260	54.3	–17
2400	8.84 – j10.7	8.20 + j10.7	2.18 – j4.77	16.3	54.1	258	54.7	–17

(1) Load impedance for optimum P1dB power.

(2) Load impedance for optimum P3dB power.

$Z_{\text{source}}$  = Measured impedance presented to the input of the device at the package reference plane.

$Z_{\text{in}}$  = Impedance as measured from gate contact to ground.

$Z_{\text{load}}$  = Measured impedance presented to the output of the device at the package reference plane.

**Figure 8. Load Pull Performance — Maximum Power Tuning**

$V_{DD} = 28 \text{ Vdc}$ ,  $I_{DQ} = 1161 \text{ mA}$ , Pulsed CW, 10  $\mu\text{sec}$ (on), 10% Duty Cycle

f (MHz)	$Z_{\text{source}} (\Omega)$	$Z_{\text{in}} (\Omega)$	Max Drain Efficiency					
			P1dB					
			$Z_{\text{load}}^{(1)} (\Omega)$	Gain (dB)	(dBm)	(W)	$\eta_D$ (%)	AM/PM (°)
2300	3.46 – j9.07	3.56 + j8.75	3.81 – j2.63	20.3	51.8	152	60.4	–14
2350	5.27 – j10.0	5.04 + j9.29	3.29 – j2.43	20.2	51.8	152	61.1	–16
2400	8.84 – j10.7	7.80 + j10.4	2.95 – j2.60	20.5	51.9	154	61.5	–16

f (MHz)	$Z_{\text{source}} (\Omega)$	$Z_{\text{in}} (\Omega)$	Max Drain Efficiency					
			P3dB					
			$Z_{\text{load}}^{(2)} (\Omega)$	Gain (dB)	(dBm)	(W)	$\eta_D$ (%)	AM/PM (°)
2300	3.46 – j9.07	3.59 + j9.10	3.67 – j2.84	18.1	52.9	193	62.7	–20
2350	5.27 – j10.0	5.26 + j9.74	3.29 – j2.76	18.0	52.9	193	63.0	–22
2400	8.84 – j10.7	8.48 + j10.9	3.06 – j2.82	18.4	52.8	192	63.0	–23

(1) Load impedance for optimum P1dB efficiency.

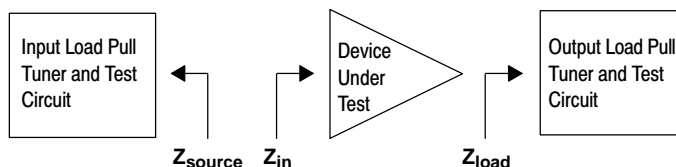
(2) Load impedance for optimum P3dB efficiency.

$Z_{\text{source}}$  = Measured impedance presented to the input of the device at the package reference plane.

$Z_{\text{in}}$  = Impedance as measured from gate contact to ground.

$Z_{\text{load}}$  = Measured impedance presented to the output of the device at the package reference plane.

**Figure 9. Load Pull Performance — Maximum Drain Efficiency Tuning**



P1dB – TYPICAL LOAD PULL CONTOURS — 2350 MHz

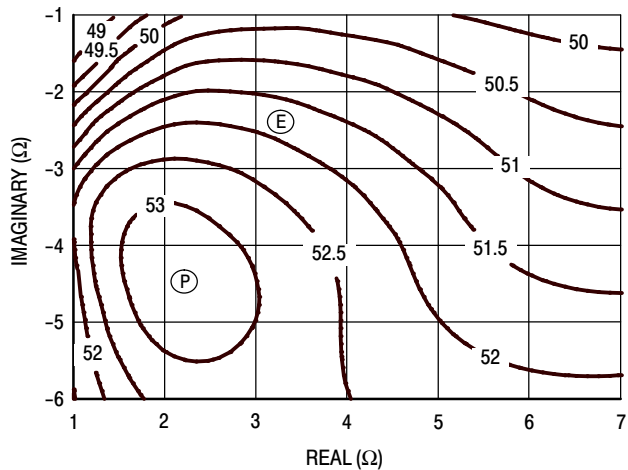


Figure 10. P1dB Load Pull Output Power Contours (dBm)

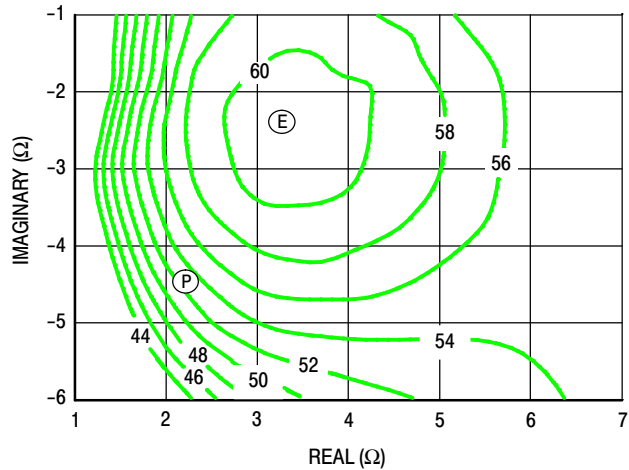


Figure 11. P1dB Load Pull Efficiency Contours (%)

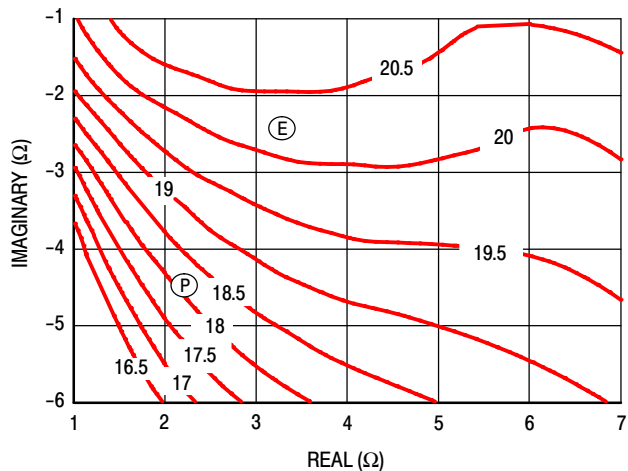


Figure 12. P1dB Load Pull Gain Contours (dB)

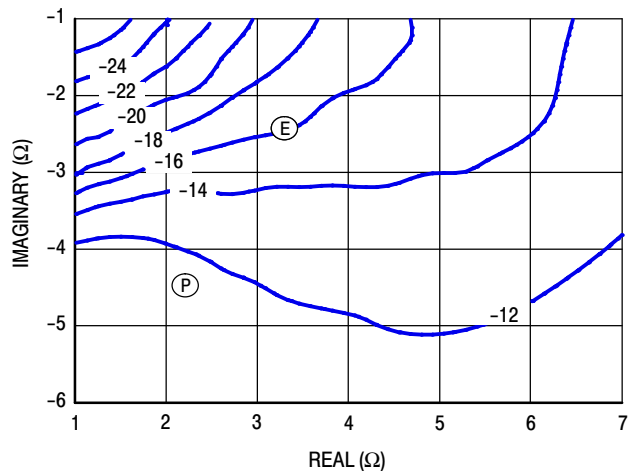


Figure 13. P1dB Load Pull AM/PM Contours (°)

**NOTE:** (P) = Maximum Output Power  
(E) = Maximum Drain Efficiency

- Power Gain
- Drain Efficiency
- Linearity
- Output Power



### P3dB – TYPICAL LOAD PULL CONTOURS — 2350 MHz

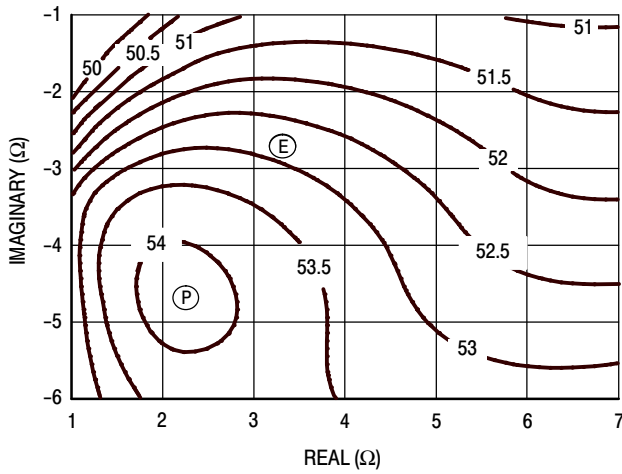


Figure 14. P3dB Load Pull Output Power Contours (dBm)

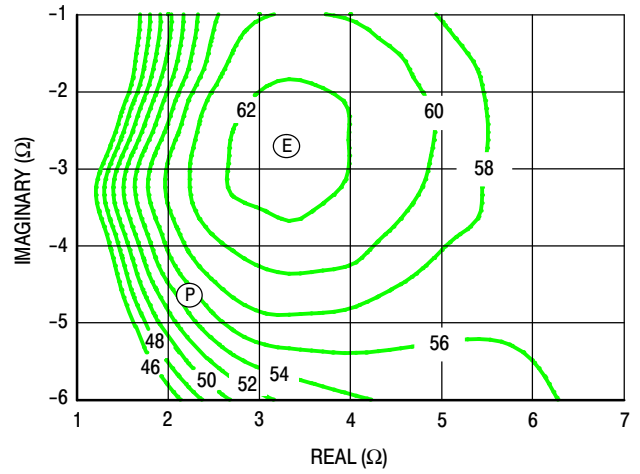


Figure 15. P3dB Load Pull Efficiency Contours (%)

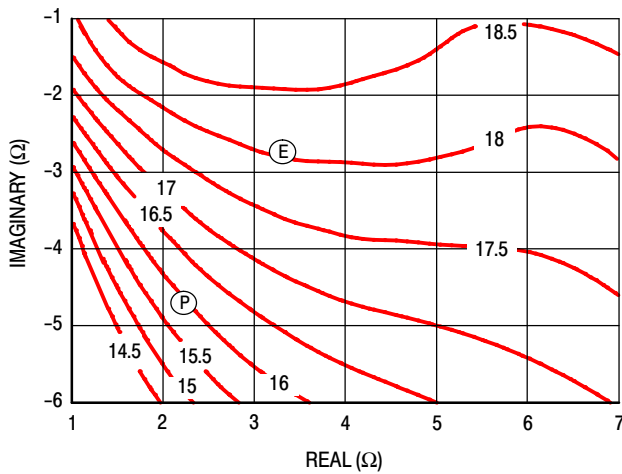


Figure 16. P3dB Load Pull Gain Contours (dB)

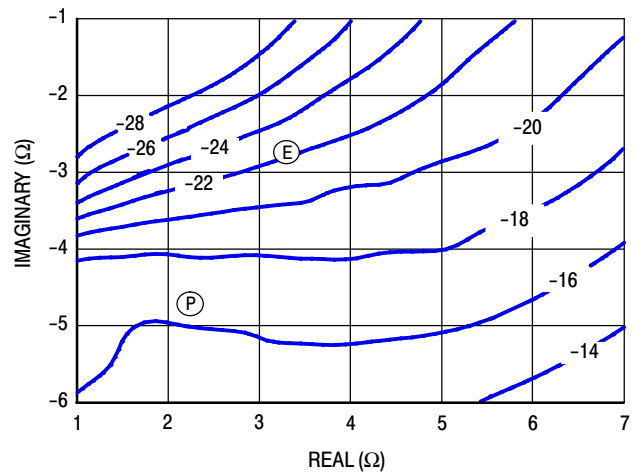
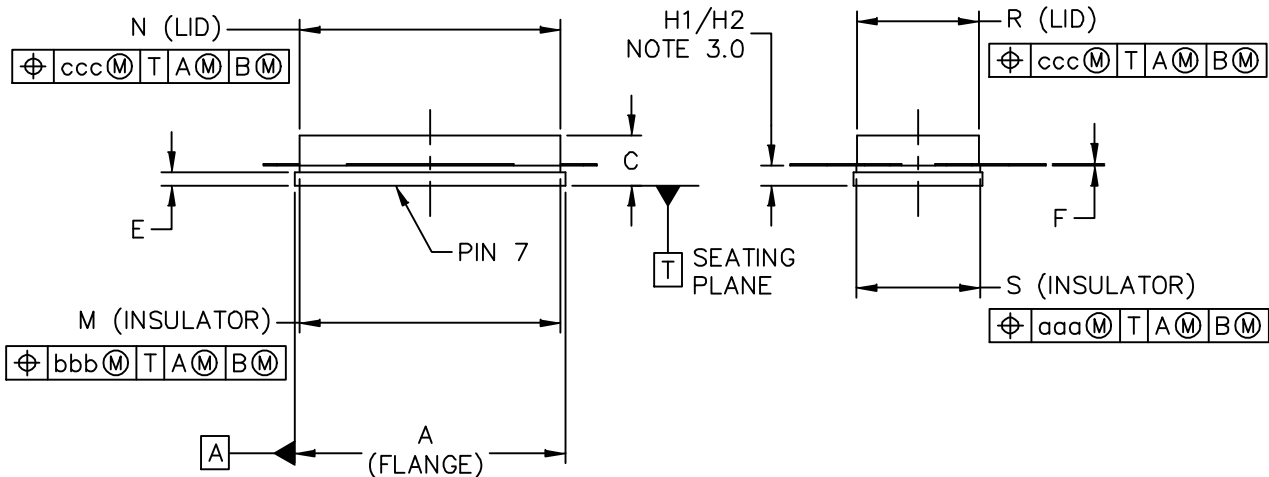
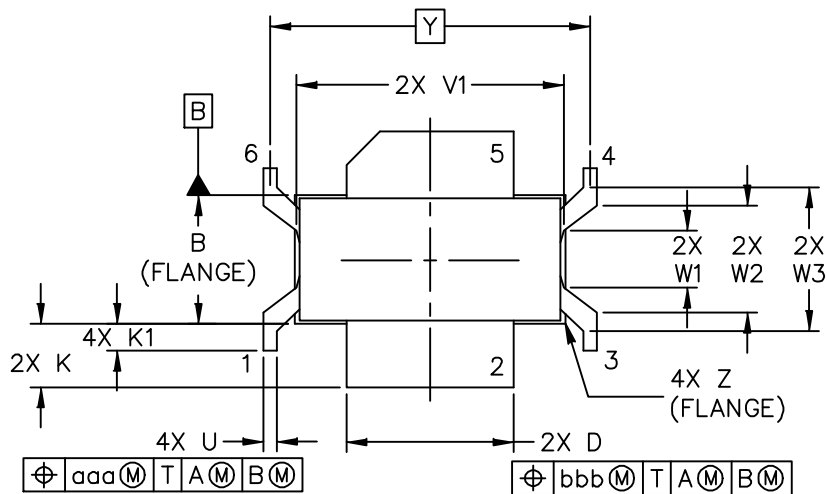


Figure 17. P3dB Load Pull AM/PM Contours (°)

**NOTE:** (E) = Maximum Output Power  
(P) = Maximum Drain Efficiency

- Power Gain
- Drain Efficiency
- Linearity
- Output Power

PACKAGE DIMENSIONS



© FREESCALE SEMICONDUCTOR, INC. ALL RIGHTS RESERVED.		MECHANICAL OUTLINE		PRINT VERSION NOT TO SCALE	
TITLE:  NI-780S-6		DOCUMENT NO: 98ASA00443D		REV: A	
		CASE NUMBER: 2268-02		24 MAY 2012	
		STANDARD: NON-JEDEC			

NOTES:

1.0 CONTROLLING DIMENSION: INCH.

2.0 INTERPRET DIMENSIONS AND TOLERANCES PER ASME Y14.5M-1994.

3.0 DIMENSIONS H1 AND H2 ARE MEASURED .030 INCH (0.762 MM) AWAY FROM FLANGE PARALLEL TO DATUM B. H1 APPLIES TO PINS 2 & 5. H2 APPLIES TO PINS 1, 3, 4 & 6.

DIM	INCH		MILLIMETER		DIM	INCH		MILLIMETER	
	MIN	MAX	MIN	MAX		MIN	MAX	MIN	MAX
A	.805	– .815	20.45	– 20.70	R	.365	– .375	9.27	– 9.53
B	.380	– .390	9.65	– 9.91	S	.365	– .375	9.27	– 9.53
C	.125	– .170	3.18	– 4.32	U	.035	– .045	0.89	– 1.14
D	.495	– .505	12.57	– 12.83	V1	.795	– .805	20.19	– 20.45
E	.035	– .045	0.89	– 1.14	W1	.165	– .175	4.19	– 4.45
F	.004	– .007	0.10	– 0.18	W2	.315	– .325	8.00	– 8.26
H1	.057	– .067	1.45	– 1.70	W3	.425	– .435	10.80	– 11.05
H2	.054	– .070	1.37	– 1.78	Y	.956 BSC		24.28 BSC	
K	.170	– .210	4.32	– 5.33	Z	R.000 – R.040		R.00 – R1.02	
K1	.070	– .090	1.78	– 2.29	aaa	– .005	–	–	0.127 –
M	.774	– .786	19.66	– 19.96	bbb	– .010	–	–	0.254 –
N	.772	– .788	19.61	– 20.02	ccc	– .015	–	–	0.381 –

© FREESCALE SEMICONDUCTOR, INC. ALL RIGHTS RESERVED.		MECHANICAL OUTLINE		PRINT VERSION NOT TO SCALE	
TITLE:  NI-780S-6			DOCUMENT NO: 98ASA00443D		REV: A
			CASE NUMBER: 2268-02		24 MAY 2012
			STANDARD: NON-JEDEC		

## PRODUCT DOCUMENTATION, SOFTWARE AND TOOLS

Refer to the following documents, software and tools to aid your design process.

### Application Notes

- AN1955: Thermal Measurement Methodology of RF Power Amplifiers

### Software

- Electromigration MTTF Calculator
- RF High Power Model
- .s2p File

### Development Tools

- Printed Circuit Boards

For Software and Tools, do a Part Number search at <http://www.freescale.com>, and select the "Part Number" link. Go to the Software & Tools tab on the part's Product Summary page to download the respective tool.

## REVISION HISTORY

The following table summarizes revisions to this document.

Revision	Date	Description
0	June 2013	<ul style="list-style-type: none"><li>• Initial Release of Data Sheet</li></ul>

## ***How to Reach Us:***

**Home Page:**  
[freescale.com](http://freescale.com)

**Web Support:**  
[freescale.com/support](http://freescale.com/support)

Information in this document is provided solely to enable system and software implementers to use Freescale products. There are no express or implied copyright licenses granted hereunder to design or fabricate any integrated circuits based on the information in this document.

Freescale reserves the right to make changes without further notice to any products herein. Freescale makes no warranty, representation, or guarantee regarding the suitability of its products for any particular purpose, nor does Freescale assume any liability arising out of the application or use of any product or circuit, and specifically disclaims any and all liability, including without limitation consequential or incidental damages. "Typical" parameters that may be provided in Freescale data sheets and/or specifications can and do vary in different applications, and actual performance may vary over time. All operating parameters, including "typicals," must be validated for each customer application by customer's technical experts. Freescale does not convey any license under its patent rights nor the rights of others. Freescale sells products pursuant to standard terms and conditions of sale, which can be found at the following address: [freescale.com/SalesTermsandConditions](http://freescale.com/SalesTermsandConditions).

Freescale and the Freescale logo are trademarks of Freescale Semiconductor, Inc., Reg. U.S. Pat. & Tm. Off. Airfast is a trademark of Freescale Semiconductor, Inc. All other product or service names are the property of their respective owners.

© 2013 Freescale Semiconductor, Inc.

