



RF LDMOS Wideband Integrated Power Amplifier

The MW7IC915N wideband integrated circuit is designed with on-chip matching that makes it usable from 698 to 960 MHz. This multi-stage structure is rated for 26 to 32 volt operation and covers all typical cellular base station modulation formats.

Driver Application — 900 MHz

- Typical Single-Carrier W-CDMA Performance: $V_{DD} = 28$ Volts, $I_{DQ1} = 52$ mA, $I_{DQ2} = 134$ mA, $P_{out} = 1.6$ Watts Avg., IQ Magnitude Clipping, Channel Bandwidth = 3.84 MHz, Input Signal PAR = 7.5 dB @ 0.01% Probability on CCDF.

Frequency	G _{ps} (dB)	PAE (%)	ACPR (dBc)
865 MHz	37.9	17.1	-50.4
880 MHz	38.0	17.4	-50.6
895 MHz	37.8	17.5	-51.3

- Capable of Handling 10:1 VSWR, @ 32 Vdc, 880 MHz, $P_{out} = 23.5$ Watts CW (3 dB Input Overdrive from Rated P_{out})
- Stable into a 5:1 VSWR. All Spurs Below -60 dBc @ 30 to 41.5 dBm CW P_{out} .
- Typical P_{out} @ 1 dB Compression Point ≈ 15.5 Watts CW

Driver Application — 700 MHz

- Typical Single-Carrier W-CDMA Performance: $V_{DD} = 28$ Volts, $I_{DQ1} = 50$ mA, $I_{DQ2} = 144$ mA, $P_{out} = 1.6$ Watts Avg., IQ Magnitude Clipping, Channel Bandwidth = 3.84 MHz, Input Signal PAR = 7.5 dB @ 0.01% Probability on CCDF.

Frequency	G _{ps} (dB)	PAE (%)	ACPR (dBc)
728 MHz	37.8	17.2	-49.5
748 MHz	37.8	17.3	-50.5
768 MHz	37.7	17.3	-51.4

Features

- Characterized with Series Equivalent Large-Signal Impedance Parameters and Common Source S-Parameters
- On-Chip Matching (50 Ohm Input, DC Blocked)
- Integrated Quiescent Current Temperature Compensation with Enable/Disable Function (1)
- Integrated ESD Protection
- In Tape and Reel. T1 Suffix = 1,000 Units, 16 mm Tape Width, 13-inch Reel.

1. Refer to AN1977, *Quiescent Current Thermal Tracking Circuit in the RF Integrated Circuit Family* and to AN1987, *Quiescent Current Control for the RF Integrated Circuit Device Family*. Go to <http://www.freescale.com/rf>. Select Documentation/Application Notes - AN1977 or AN1987.

MW7IC915NT1

728-960 MHz, 1.6 W AVG., 28 V
 SINGLE W-CDMA
 RF LDMOS WIDEBAND
 INTEGRATED POWER AMPLIFIER

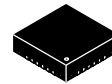

PQFN 8 x 8
 PLASTIC

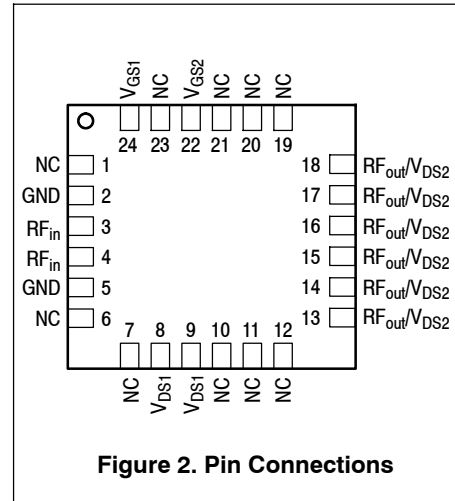
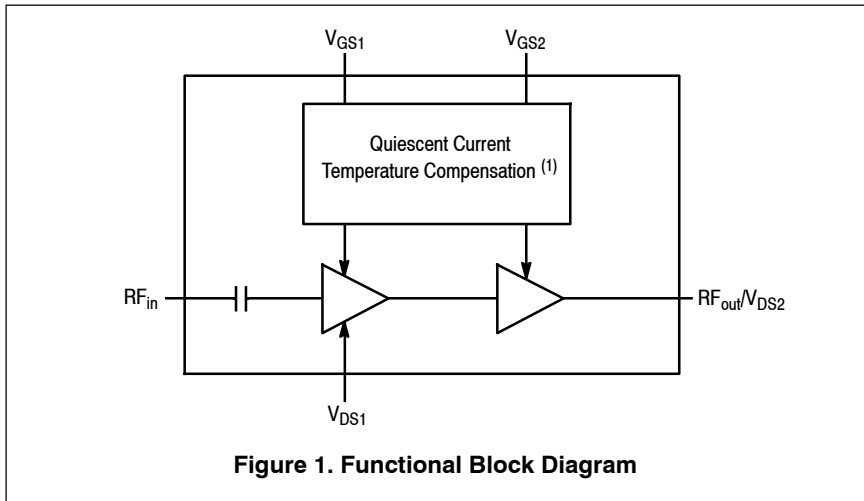

1. Refer to AN1977, *Quiescent Current Thermal Tracking Circuit in the RF Integrated Circuit Family* and to AN1987, *Quiescent Current Control for the RF Integrated Circuit Device Family*. Go to <http://www.freescale.com/rf>. Select Documentation/Application Notes - AN1977 or AN1987.

Table 1. Maximum Ratings

Rating	Symbol	Value	Unit
Drain-Source Voltage	V_{DSS}	-0.5, +65	Vdc
Gate-Source Voltage	V_{GS}	-6.0, +10	Vdc
Operating Voltage	V_{DD}	32, +0	Vdc
Storage Temperature Range	T_{stg}	-65 to +150	°C
Operating Junction Temperature (1)	T_J	150	°C
Input Power	P_{in}	17	dBm

Table 2. Thermal Characteristics

Characteristic	Symbol	Value (1,2)	Unit
Thermal Resistance, Junction to Case	$R_{\theta JC}$		°C/W
W-CDMA Application (Case Temperature 82°C, $P_{out} = 1.6$ W CW)		7.5 3.2	
		Stage 1, 28 Vdc, $I_{DQ1} = 60$ mA Stage 2, 28 Vdc, $I_{DQ2} = 130$ mA	

Table 3. ESD Protection Characteristics

Test Methodology	Class
Human Body Model (per JESD22-A114)	1B
Machine Model (per EIA/JESD22-A115)	A
Charge Device Model (per JESD22-C101)	III

Table 4. Moisture Sensitivity Level

Test Methodology	Rating	Package Peak Temperature	Unit
Per JESD22-A113, IPC/JEDEC J-STD-020	3	260	°C

1. MTTF calculator available at <http://www.freescale.com/rf>. Select Software & Tools/Development Tools/Calculators to access MTTF calculators by product.
2. Refer to AN1955, *Thermal Measurement Methodology of RF Power Amplifiers*. Go to <http://www.freescale.com/rf>. Select Documentation/Application Notes - AN1955.

Table 5. Electrical Characteristics ($T_A = 25^\circ\text{C}$ unless otherwise noted)

Characteristic	Symbol	Min	Typ	Max	Unit
Stage 1 — Off Characteristics					
Zero Gate Voltage Drain Leakage Current ($V_{DS} = 65\text{ Vdc}$, $V_{GS} = 0\text{ Vdc}$)	I_{DSS}	—	—	10	μA
Zero Gate Voltage Drain Leakage Current ($V_{DS} = 28\text{ Vdc}$, $V_{GS} = 0\text{ Vdc}$)	I_{DSS}	—	—	1	μA
Gate-Source Leakage Current ($V_{GS} = 1.5\text{ Vdc}$, $V_{DS} = 0\text{ Vdc}$)	I_{GSS}	—	—	1	μA

Stage 1 — On Characteristics

Gate Threshold Voltage ($V_{DS} = 10\text{ Vdc}$, $I_D = 9\ \mu\text{A}$)	$V_{GS(th)}$	1	2	3	Vdc
Gate Quiescent Voltage ($V_{DS} = 28\text{ Vdc}$, $I_D = 52\text{ mA}$)	$V_{GS(Q)}$	—	3	—	Vdc
Fixture Gate Quiescent Voltage ($V_{DD} = 28\text{ Vdc}$, $I_D = 52\text{ mA}$, Measured in Functional Test)	$V_{GG(Q)}$	5.5	6.3	7	Vdc

Stage 2 — Off Characteristics

Zero Gate Voltage Drain Leakage Current ($V_{DS} = 65\text{ Vdc}$, $V_{GS} = 0\text{ Vdc}$)	I_{DSS}	—	—	10	μA
Zero Gate Voltage Drain Leakage Current ($V_{DS} = 28\text{ Vdc}$, $V_{GS} = 0\text{ Vdc}$)	I_{DSS}	—	—	1	μA
Gate-Source Leakage Current ($V_{GS} = 1.5\text{ Vdc}$, $V_{DS} = 0\text{ Vdc}$)	I_{GSS}	—	—	1	μA

Stage 2 — On Characteristics

Gate Threshold Voltage ($V_{DS} = 10\text{ Vdc}$, $I_D = 36\ \mu\text{A}$)	$V_{GS(th)}$	1	2	3	Vdc
Gate Quiescent Voltage ($V_{DS} = 28\text{ Vdc}$, $I_D = 134\text{ mA}$)	$V_{GS(Q)}$	—	2.9	—	Vdc
Fixture Gate Quiescent Voltage ($V_{DD} = 28\text{ Vdc}$, $I_D = 134\text{ mA}$, Measured in Functional Test)	$V_{GG(Q)}$	3.8	4.6	5.3	Vdc
Drain-Source On-Voltage ($V_{GS} = 10\text{ Vdc}$, $I_D = 3.6\text{ A}$)	$V_{DS(on)}$	0.1	0.3	0.8	Vdc

Functional Tests ⁽¹⁾ (In Freescale Test Fixture, 50 ohm system) $V_{DD} = 28\text{ Vdc}$, $I_{DQ1} = 52\text{ mA}$, $I_{DQ2} = 134\text{ mA}$, $P_{out} = 1.6\text{ W Avg.}$, $f = 880\text{ MHz}$, Single-Carrier W-CDMA, IQ Magnitude Clipping, Input Signal PAR = 7.5 dB @ 0.01% Probability on CCDF. ACPR measured in 3.84 MHz Channel Bandwidth @ $\pm 5\text{ MHz}$ Offset.

Power Gain	G_{ps}	35.0	38.0	41.0	dB
Power Added Efficiency	PAE	15.0	17.4	—	%
Adjacent Channel Power Ratio	ACPR	—	-50.6	-47.0	dBc
Input Return Loss	IRL	—	-22	-9	dB

Typical Performance over Frequency (In Freescale Test Fixture, 50 ohm system) $V_{DD} = 28\text{ Vdc}$, $I_{DQ1} = 52\text{ mA}$, $I_{DQ2} = 134\text{ mA}$, $P_{out} = 1.6\text{ W Avg.}$, Single-Carrier W-CDMA, IQ Magnitude Clipping, Input Signal PAR = 7.5 dB @ 0.01% Probability on CCDF. ACPR measured in 3.84 MHz Channel Bandwidth @ $\pm 5\text{ MHz}$ Offset.

Frequency	G_{ps} (dB)	PAE (%)	ACPR (dBc)	IRL (dB)
865 MHz	37.9	17.1	-50.4	-21
880 MHz	38.0	17.4	-50.6	-22
895 MHz	37.8	17.5	-51.3	-22

1. Part internally input matched.

(continued)

Table 5. Electrical Characteristics ($T_A = 25^\circ\text{C}$ unless otherwise noted) (continued)

Characteristic	Symbol	Min	Typ	Max	Unit
Typical Performances (In Freescale Test Fixture, 50 ohm system) $V_{DD} = 28\text{ Vdc}$, $I_{DQ1} = 52\text{ mA}$, $I_{DQ2} = 134\text{ mA}$, 865-895 MHz Bandwidth					
P_{out} @ 1 dB Compression Point, CW ($V_{DD} = 28\text{ Vdc}$, $I_{DQ1} = 75\text{ mA}$, $I_{DQ2} = 100\text{ mA}$)	P1dB	—	15.5	—	W
IMD Symmetry @ 16 W PEP, P_{out} where IMD Third Order Intermodulation $\cong 30\text{ dBc}$ (Delta IMD Third Order Intermodulation between Upper and Lower Sidebands $> 2\text{ dB}$)	IMD _{sym}	—	45	—	MHz
VBW Resonance Point (IMD Third Order Intermodulation Inflection Point)	VBW _{res}	—	180	—	MHz
Quiescent Current Accuracy over Temperature ⁽¹⁾ with 2 k Ω Gate Feed Resistors (-30 to 85°C)	ΔI_{QT}	— —	0.10 0.12	— —	%
Gain Flatness in 30 MHz Bandwidth @ $P_{out} = 1.6\text{ W Avg.}$	G_F	—	0.1	—	dB
Gain Variation over Temperature (-30°C to $+85^\circ\text{C}$)	ΔG	—	0.041	—	dB/ $^\circ\text{C}$
Output Power Variation over Temperature (-30°C to $+85^\circ\text{C}$)	$\Delta P1\text{dB}$	—	0.004	—	dBm/ $^\circ\text{C}$

Typical Performance — 700 MHz (In Freescale 700 MHz Test Fixture, 50 ohm system) $V_{DD} = 28\text{ Vdc}$, $I_{DQ1} = 50\text{ mA}$, $I_{DQ2} = 144\text{ mA}$, $P_{out} = 1.6\text{ W Avg.}$, Single-Carrier W-CDMA, IQ Magnitude Clipping, Input Signal PAR = 7.5 dB @ 0.01% Probability on CCDF. ACPR measured in 3.84 MHz Channel Bandwidth @ $\pm 5\text{ MHz}$ Offset.

Frequency	G_{ps} (dB)	PAE (%)	ACPR (dBc)	IRL (dB)
728 MHz	37.8	17.2	-49.5	-23
748 MHz	37.8	17.3	-50.5	-22
768 MHz	37.7	17.3	-51.4	-22

1. Refer to AN1977, *Quiescent Current Thermal Tracking Circuit in the RF Integrated Circuit Family* and to AN1987, *Quiescent Current Control for the RF Integrated Circuit Device Family*. Go to <http://www.freescale.com/rf>. Select Documentation/Application Notes - AN1977 or AN1987.

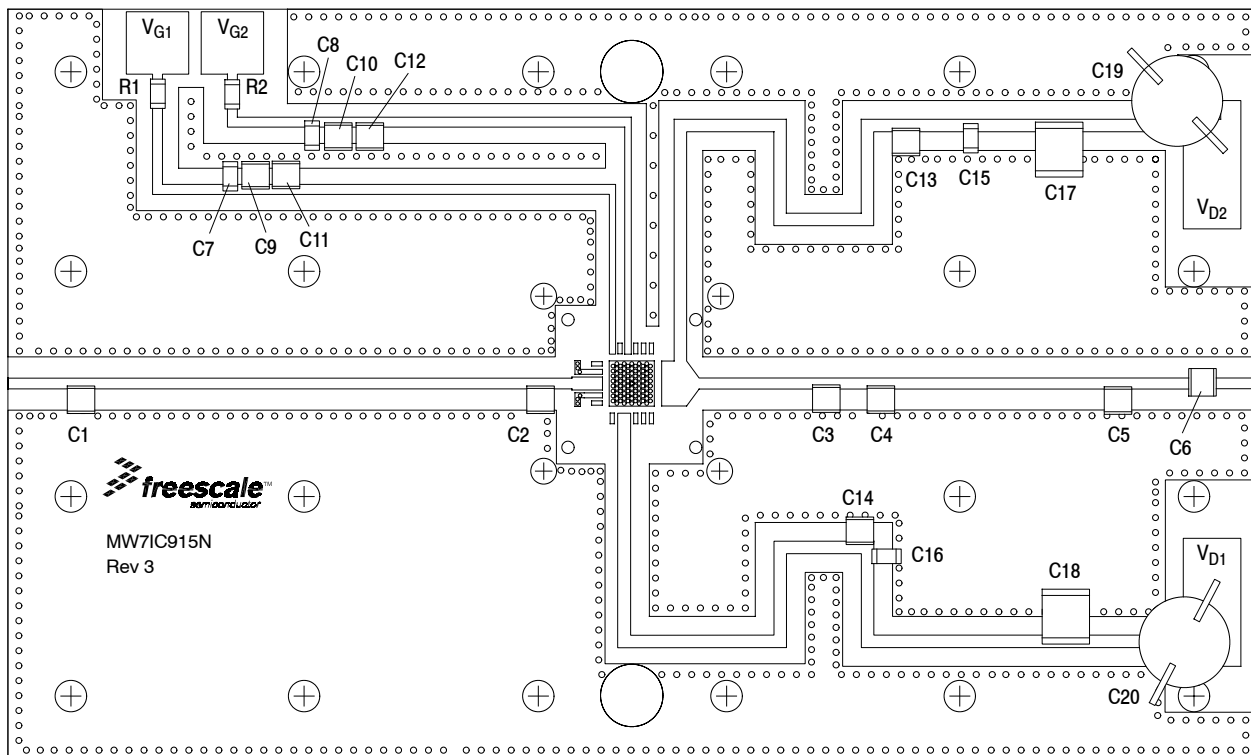

Figure 3. MW7IC915NT1 Test Circuit Component Layout

Table 6. MW7IC915NT1 Test Circuit Component Designations and Values

Part	Description	Part Number	Manufacturer
C1	1.8 pF Chip Capacitor	ATC100B1R8BT500XT	ATC
C2, C5	0.8 pF Chip Capacitors	ATC100B0R8BT500XT	ATC
C3	6.2 pF Chip Capacitor	ATC100B6R2BT500XT	ATC
C4	3.3 pF Chip Capacitor	ATC100B3R3CT500XT	ATC
C6, C11, C12, C13, C14	47 pF Chip Capacitors	ATC100B470JT500XT	ATC
C7, C8	1 μ F Chip Capacitors	GRM31MR71H105KA88L	Murata
C9, C10	0.1 μ F Chip Capacitors	GRM32MR71H104JA01L	Murata
C15, C16	4.7 μ F Chip Capacitors	GRM31CR71H475KA12L	Murata
C17, C18	10 μ F, 50 V Chip Capacitors	GRM55DR61H106KA88L	Murata
C19, C20	100 μ F, 50 V Electrolytic Capacitors	MCGPR50V107M8X11 -RH	Multicomp
R1, R2	2 k Ω , 1/4 W Resistors	CRCW12062K00FKEA	Vishay
PCB	0.020", $\epsilon_r = 3.66$	RO4350B	Rogers

TYPICAL CHARACTERISTICS

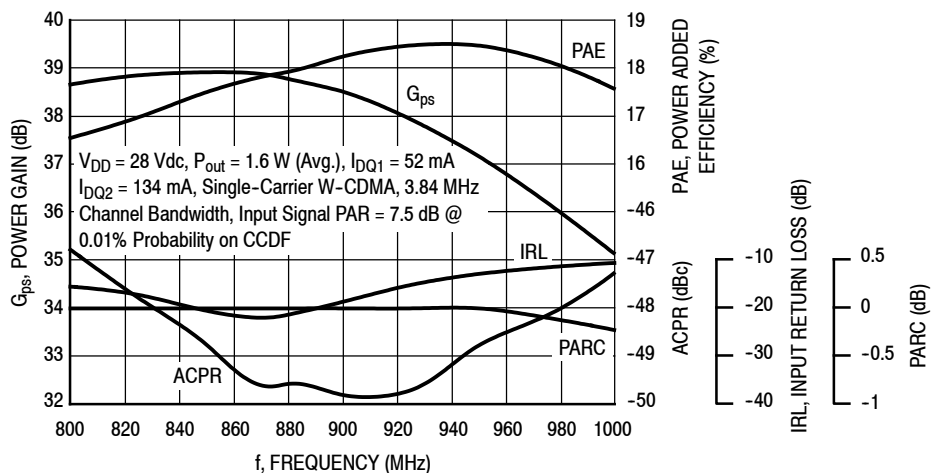

Figure 4. Output Peak-to-Average Ratio Compression (PARC) Broadband Performance @ $P_{out} = 1.6$ Watts Avg.

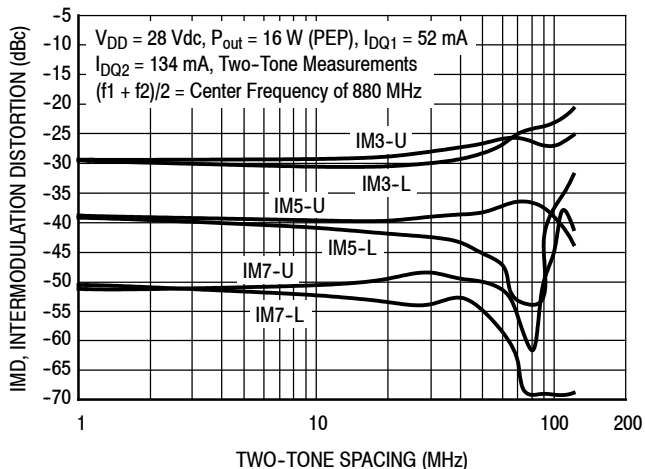

Figure 5. Intermodulation Distortion Products versus Two-Tone Spacing

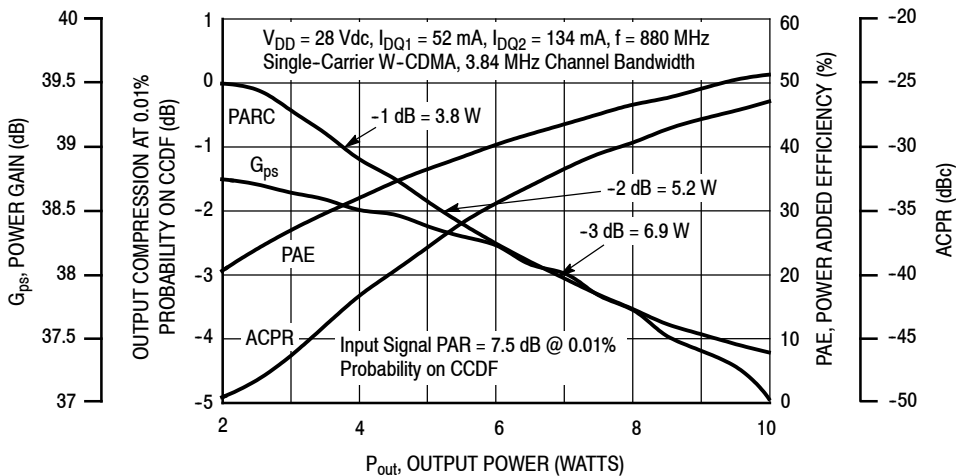

Figure 6. Output Peak-to-Average Ratio Compression (PARC) versus Output Power

TYPICAL CHARACTERISTICS

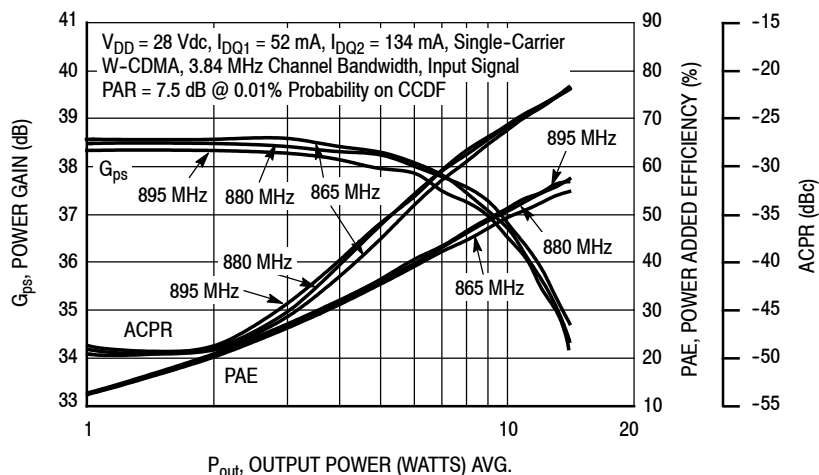

Figure 7. Single-Carrier W-CDMA Power Gain, Power Added Efficiency and ACPR versus Output Power

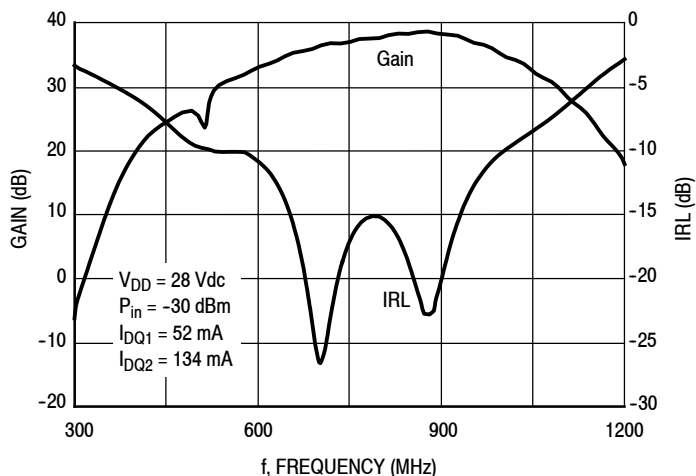

Figure 8. Broadband Frequency Response

W-CDMA TEST SIGNAL

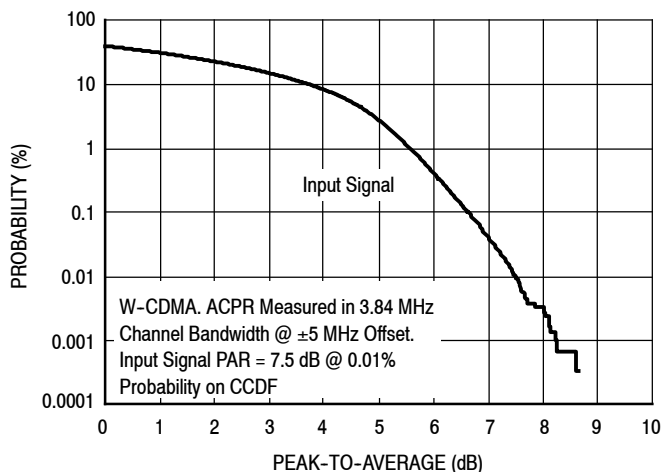

Figure 9. CCDF W-CDMA IQ Magnitude Clipping, Single-Carrier Test Signal

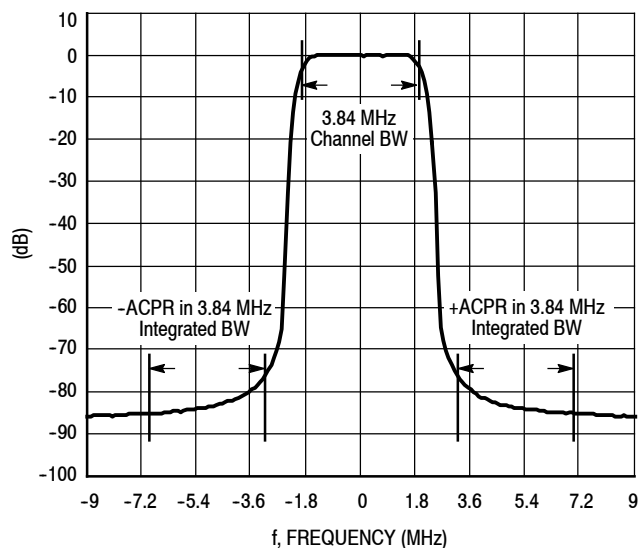

Figure 10. Single-Carrier W-CDMA Spectrum

MW71C915NT1

$V_{DD} = 28 \text{ Vdc}$, $I_{DQ1} = 52 \text{ mA}$, $I_{DQ2} = 134 \text{ mA}$, $P_{out} = 1.6 \text{ W Avg.}$

f MHz	Z_{in} Ω	Z_{load} Ω
820	52.99 - j29.47	7.72 + j13.96
840	49.35 - j27.56	7.34 + j14.74
860	46.67 - j23.60	7.43 + j15.55
880	44.88 - j17.63	7.94 + j16.07
900	43.73 - j10.46	7.98 + j16.74
920	43.12 - j2.75	7.80 + j17.62
940	43.38 + j5.01	8.28 + j18.33
960	44.07 + j12.97	9.07 + j19.04
980	43.89 + j12.61	9.14 + j20.02

Z_{in} = Device input impedance as measured from gate to ground.

Z_{load} = Test circuit impedance as measured from drain to ground.

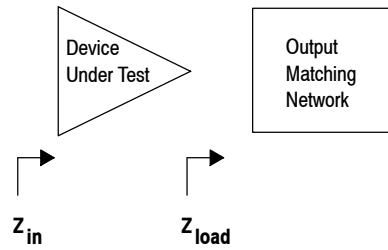
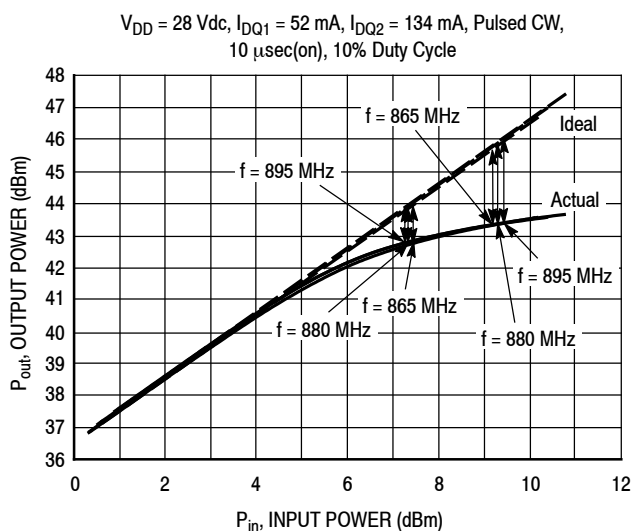

Figure 11. Series Equivalent Input and Load Impedance

ALTERNATIVE PEAK TUNE LOAD PULL CHARACTERISTICS



f (MHz)	P1dB		P3dB	
	Watts	dBm	Watts	dBm
865	18.1	42.6	22.4	43.5
880	18.5	42.7	22.3	43.5
895	18.5	42.7	22.2	43.5

Test Impedances per Compression Level

f (MHz)		Z_{source} Ω	Z_{load} Ω
865	P1dB	$48.7 + j15.6$	$6.8 + j6.5$
880	P1dB	$52.3 + j20.8$	$6.9 + j6.7$
895	P1dB	$55.1 + j22.2$	$7.4 + j6.7$

Figure 12. Pulsed CW Output Power versus Input Power @ 28 V

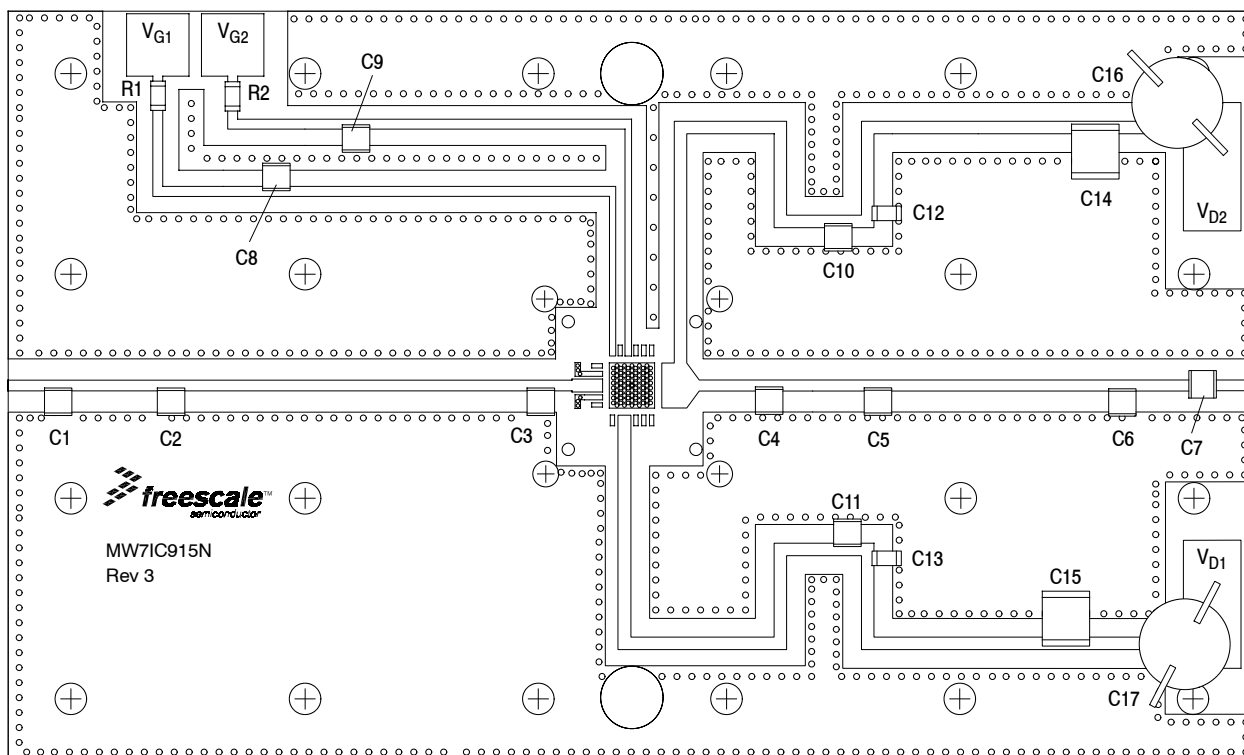

Figure 13. MW7IC915NT1 Test Circuit Component Layout — 700 MHz

Table 7. MW7IC915NT1 Test Circuit Component Designations and Values — 700 MHz

Part	Description	Part Number	Manufacturer
C1, C3, C6	2.7 pF Chip Capacitors	ATC100B2R7BT500XT	ATC
C2	0.3 pF Chip Capacitor	ATC100B0R3BT500XT	ATC
C4	4.7 pF Chip Capacitor	ATC100B4R7CT500XT	ATC
C5	5.6 pF Chip Capacitor	ATC100B5R6CT500XT	ATC
C7, C8, C9, C10, C11	47 pF Chip Capacitors	ATC100B470JT500XT	ATC
C12, C13	4.7 μ F Chip Capacitors	GRM31CR71H475KA12L	Murata
C14, C15	10 μ F, 50 V Chip Capacitors	GRM55DR61H106KA88L	Murata
C16, C17	100 μ F, 50 V Electrolytic Capacitors	MCGPR50V107M8X11-RH	Multicomp
R1, R2	2 k Ω , 1/4 W Resistors	CRCW12062K00FKEA	Vishay
PCB	0.020", $\epsilon_r = 3.66$	RO4350B	Rogers

TYPICAL CHARACTERISTICS — 700 MHz

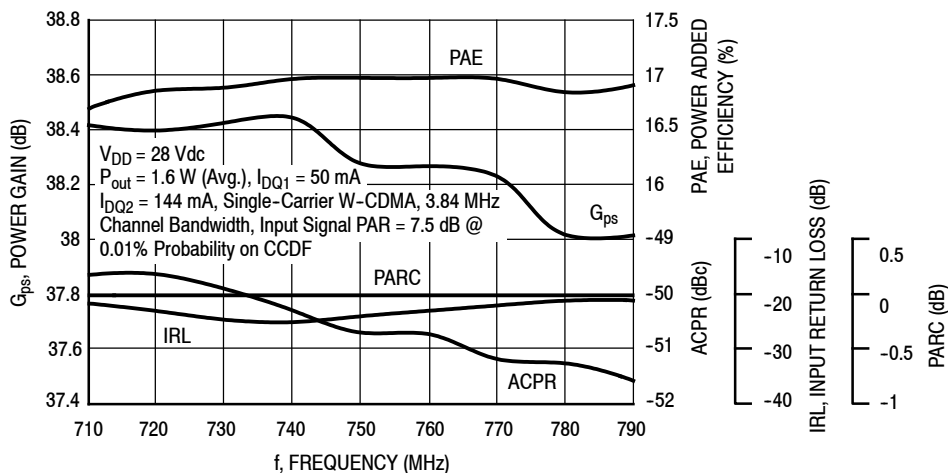

Figure 14. Output Peak-to-Average Ratio Compression (PARC) Broadband Performance @ $P_{out} = 1.6$ Watts Avg.

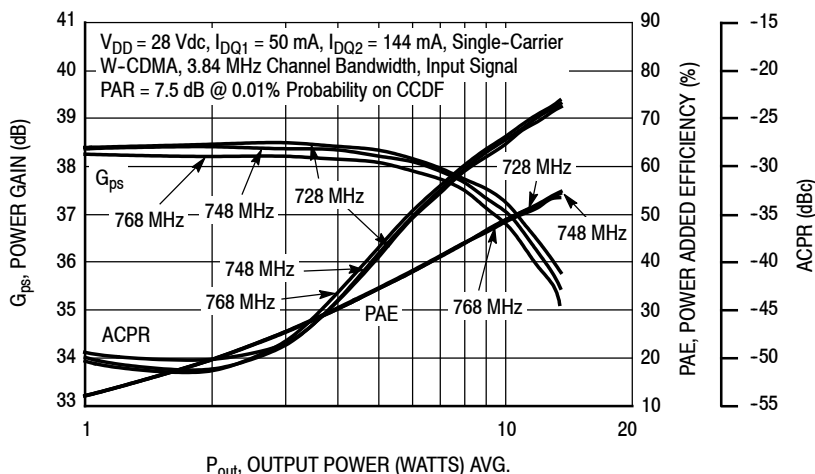

Figure 15. Single-Carrier W-CDMA Power Gain, Power Added Efficiency and ACPR versus Output Power

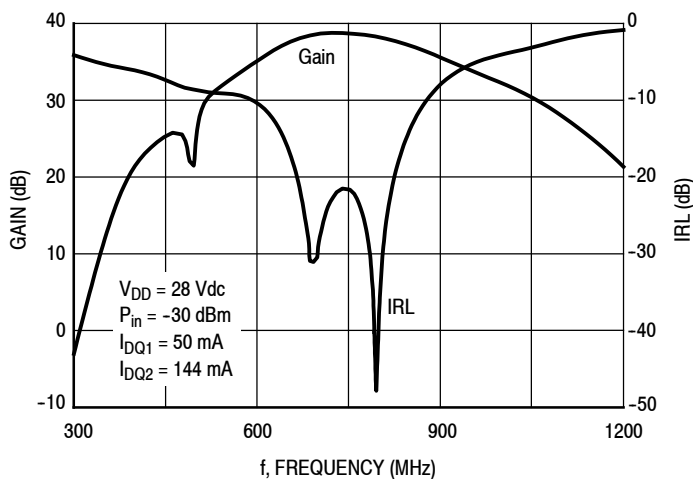

Figure 16. Broadband Frequency Response

$V_{DD} = 28 \text{ Vdc}$, $I_{DQ1} = 50 \text{ mA}$, $I_{DQ2} = 144 \text{ mA}$, $P_{out} = 1.6 \text{ W Avg.}$

f MHz	Z_{in} Ω	Z_{load} Ω
710	54.61 - j2.01	9.57 + j6.52
720	55.46 + j0.26	9.95 + j7.04
730	56.75 + j2.12	10.70 + j7.79
740	58.35 + j3.55	11.39 + j8.18
750	60.11 + j4.65	11.41 + j8.07
760	61.83 + j5.22	11.00 + j7.90
770	63.19 + j5.31	10.88 + j7.88
780	64.01 + j4.90	11.41 + j7.87
790	64.18 + j3.91	12.32 + j7.61

Z_{in} = Device input impedance as measured from gate to ground.

Z_{load} = Test circuit impedance as measured from drain to ground.

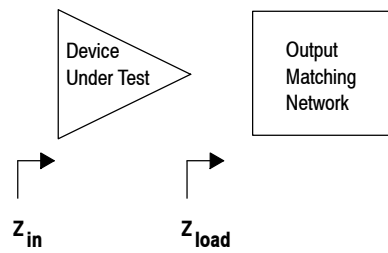
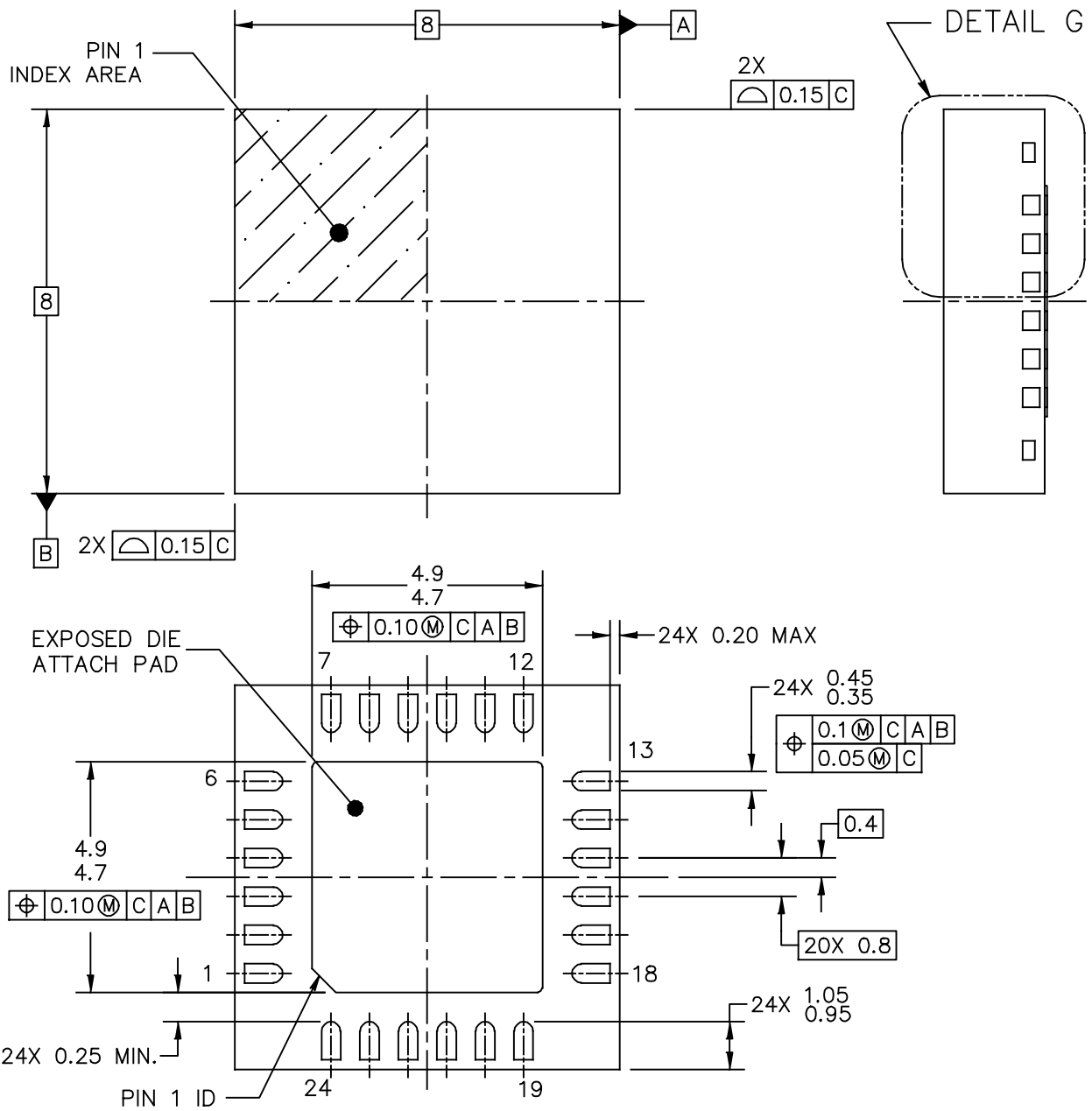

Figure 17. Series Equivalent Input and Load Impedance — 700 MHz

PACKAGE DIMENSIONS



© FREESCALE SEMICONDUCTOR, INC. ALL RIGHTS RESERVED.	MECHANICAL OUTLINE	PRINT VERSION NOT TO SCALE	
TITLE: PQFN (SAW), THERMALLY ENHANCED 8 X 8 X 2.1, 0.8 PITCH, 24 TERMINAL	DOCUMENT NO: 98ASA10760D	REV: A	
	CASE NUMBER: 1894-02	29 MAY 2012	
	STANDARD: NON-JEDEC		

MW71C915NT1

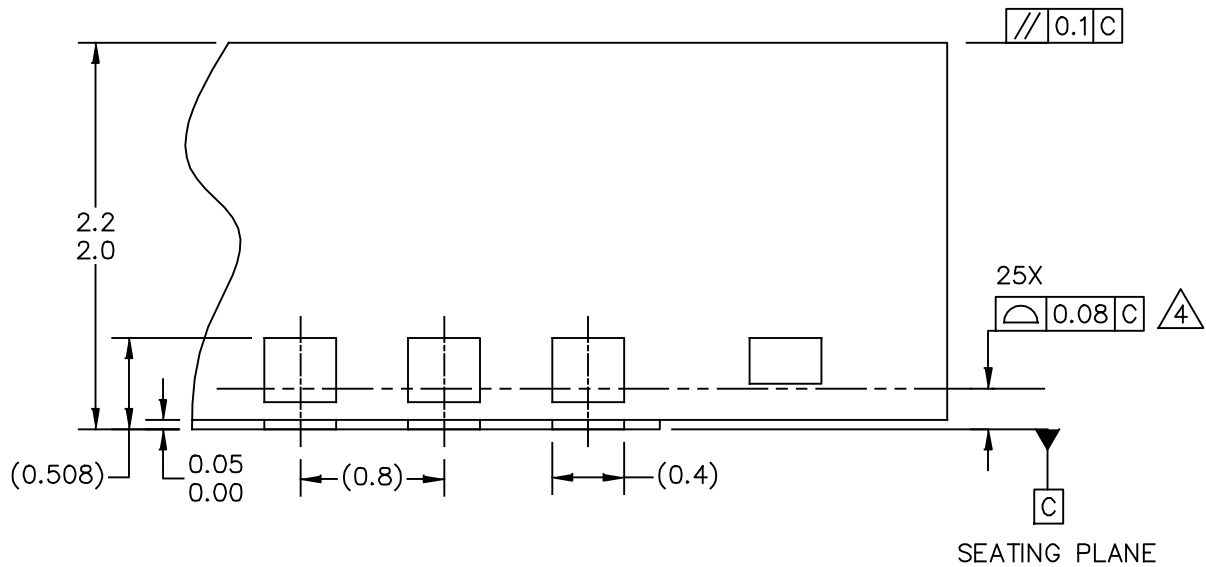

DETAIL G
VIEW ROTATED 90° CW

© FREESCALE SEMICONDUCTOR, INC. ALL RIGHTS RESERVED.	MECHANICAL OUTLINE	PRINT VERSION NOT TO SCALE	
TITLE: PQFN (SAW), THERMALLY ENHANCED 8 X 8 X 2.1, 0.8 PITCH, 24 TERMINAL	DOCUMENT NO: 98ASA10760D	REV: A	
	CASE NUMBER: 1894-02	29 MAY 2012	
	STANDARD: NON-JEDEC		

NOTES:

1. ALL DIMENSIONS ARE IN MILLIMETERS.
2. DIMENSIONING AND TOLERANCING PER ASME Y14.5M-1994.
3. THE COMPLETE JEDEC DESIGNATOR FOR THIS PACKAGE IS: HF-PQFN.
4.  COPLANARITY APPLIES TO LEADS AND DIE ATTACH PAD.

© FREESCALE SEMICONDUCTOR, INC. ALL RIGHTS RESERVED.	MECHANICAL OUTLINE	PRINT VERSION NOT TO SCALE	
TITLE: PQFN (SAW), THERMALLY ENHANCED 8 X 8 X 2.1, 0.8 PITCH, 24 TERMINAL	DOCUMENT NO: 98ASA10760D	REV: A	
	CASE NUMBER: 1894-02	29 MAY 2012	
	STANDARD: NON-JEDEC		

PRODUCT DOCUMENTATION, TOOLS AND SOFTWARE

Refer to the following documents to aid your design process.

Application Notes

- AN1955: Thermal Measurement Methodology of RF Power Amplifiers
- AN1977: Quiescent Current Thermal Tracking Circuit in the RF Integrated Circuit Family
- AN1987: Quiescent Current Control for the RF Integrated Circuit Device Family

Engineering Bulletins

- EB212: Using Data Sheet Impedances for RF LDMOS Devices

Software

- Electromigration MTTF Calculator
- RF High Power Model
- .s2p File

For Software and Tools, do a Part Number search at <http://www.freescale.com>, and select the “Part Number” link. Go to the Software & Tools tab on the part’s Product Summary page to download the respective tool.

REVISION HISTORY

The following table summarizes revisions to this document.

Revision	Date	Description
0	Sept. 2009	<ul style="list-style-type: none">• Initial Release of Data Sheet
1	Dec. 2009	<ul style="list-style-type: none">• Table 4, Moisture Sensitivity Level, corrected Package Peak Temperature to 260°C, p. 2
2	Dec. 2013	<ul style="list-style-type: none">• Table 1, Maximum Ratings: increased input power from 4.7 dBm to 17 dBm to reflect the true capability of the device, p. 2• Table 3, ESD Protection Characteristics, removed the word “Minimum” after the ESD class rating. ESD ratings are characterized during new product development but are not 100% tested during production. ESD ratings provided in the data sheet are intended to be used as a guideline when handling ESD sensitive devices, p. 2• Table 6, Test Circuit Component Designations and Values: corrected C9, C10 chip capacitor description from 0.01 to 0.1 pF, p. 5. Table 6 (900 MHz component designations) and Table 7 (700 MHz component designations): added PCB material information, pp. 5, 10• Replaced Case Outline 98ASA10760D, Rev. O with Rev. A, pp. 13-15. Mechanical outline drawing modified to reflect the correct lead end features. Format of the mechanical outline was also updated to the current Freescale format for Freescale mechanical outlines.

How to Reach Us:

Home Page:
freescale.com

Web Support:
freescale.com/support

Information in this document is provided solely to enable system and software implementers to use Freescale products. There are no express or implied copyright licenses granted hereunder to design or fabricate any integrated circuits based on the information in this document.

Freescale reserves the right to make changes without further notice to any products herein. Freescale makes no warranty, representation, or guarantee regarding the suitability of its products for any particular purpose, nor does Freescale assume any liability arising out of the application or use of any product or circuit, and specifically disclaims any and all liability, including without limitation consequential or incidental damages. "Typical" parameters that may be provided in Freescale data sheets and/or specifications can and do vary in different applications, and actual performance may vary over time. All operating parameters, including "typicals," must be validated for each customer application by customer's technical experts. Freescale does not convey any license under its patent rights nor the rights of others. Freescale sells products pursuant to standard terms and conditions of sale, which can be found at the following address: freescale.com/SalesTermsandConditions.

Freescale and the Freescale logo are trademarks of Freescale Semiconductor, Inc., Reg. U.S. Pat. & Tm. Off. All other product or service names are the property of their respective owners.

© 2009, 2013 Freescale Semiconductor, Inc.

