



# MIC916

## Triple 135MHz Low-Power Op Amp

### General Description

The MIC916 is a high-speed, unity-gain stable operational amplifier. It provides a gain-bandwidth product of 135MHz with a very low, 2.4mA supply current per op amp.

Supply voltage range is from  $\pm 2.5V$  to  $\pm 9V$ , allowing the MIC916 to be used in low-voltage circuits or applications requiring large dynamic range.

The MIC916 is stable driving any capacitive load and achieves excellent PSRR, making it much easier to use than most conventional high-speed devices. Low supply voltage, low power consumption, and small packing make the MIC916 ideal for portable equipment. The ability to drive capacitive loads also makes it possible to drive long coaxial cables.

### Features

- 135MHz gain bandwidth product
- 2.4mA supply current per op amp
- QSOP-16 package
- 270V/ $\mu s$  slew rate
- drives any capacitive load

### Applications

- Video
- Imaging
- Ultrasound
- Portable equipment

### Ordering Information

Part Number		Junction Temp. Range	Package
Standard	Pb-Free		
MIC916BQS	MIC916YQS	$-40^{\circ}C$ to $+85^{\circ}C$	QSOP-16

### Pin Configuration

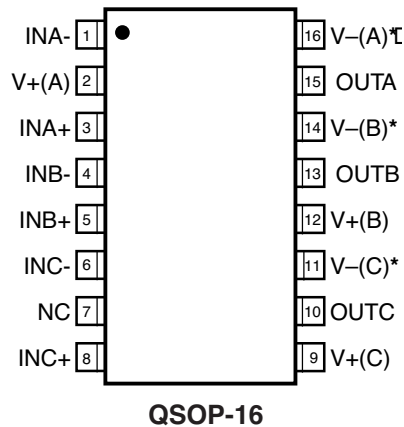

\* V- pins must be externally shorted together

**Pin Description**

Pin Number	Pin Name	Pin Function
1	INA-	Inverting Input A
2	V+(A)	Positive Supply Input (Op Amp A)
3	INA+	Noninverting Input A
4	INB-	Inverting Input B
5	INB+	Noninverting Input B
6	INC-	Inverting Input C
7	NC	Not Connected
8	INC+	Noninverting Input C
9	V+(C)	Positive Supply Input (Op Amp C)
10	OUTC	Output C
11	V-(C)	Negative Supply Input (Op Amp C)
12	V+(B)	Positive Supply Input(Op Amp B)
13	OUTB	Output B
14	V-(B)	Negative Supply Input (Op Amp B)
15	OUTA	Output A
16	V-(A)	Negative Supply Input (Op Amp A)

**Absolute Maximum Ratings (Note 1)**

Supply Voltage ( $V_{V+} - V_{V-}$ )	20V
Differential Input Voltage ( $ V_{IN+} - V_{IN-} $ )	8V, <b>Note 4</b>
Input Common-Mode Range ( $V_{IN+}, V_{IN-}$ )	$V_{V+}$ to $V_{V-}$
Lead Temperature (soldering, 5 sec.)	260°C
Storage Temperature ( $T_S$ )	150°C
ESD Rating, <b>Note 3</b>	1.5kV

**Operating Ratings (Note 2)**

Supply Voltage ( $V_S$ )	$\pm 2.5V$ to $\pm 9V$
Junction Temperature ( $T_J$ )	$-40^\circ C$ to $+85^\circ C$
Package Thermal Resistance	260°C/W

**Electrical Characteristics ( $\pm 5V$ )**

$V_{V+} = +5V$ ,  $V_{V-} = -5V$ ,  $V_{CM} = 0V$ ,  $V_{OUT} = 0V$ ;  $R_L = 10M\Omega$ ;  $T_J = 25^\circ C$ , **bold** values indicate  $-40^\circ C \leq T_J \leq +85^\circ C$ ; unless noted.

Symbol	Parameter	Condition	Min	Typ	Max	Units
$V_{OS}$	Input Offset Voltage			1	<b>15</b>	mV
$V_{OS}$	Input Offset Voltage Temperature Coefficient			4		$\mu V/^\circ C$
$I_B$	Input Bias Current			3.5	5.5 <b>9</b>	$\mu A$ $\mu A$
$I_{OS}$	Input Offset Current			0.05	<b>3</b>	$\mu A$
$V_{CM}$	Input Common-Mode Range	CMRR > 60dB	-3.25		+3.25	V
CMRR	Common-Mode Rejection Ratio	$-2.5V < V_{CM} < +2.5V$	70 <b>60</b>	90		dB dB
PSRR	Power Supply Rejection Ratio	$\pm 5V < V_S < \pm 9V$	74 <b>70</b>	81		dB dB
$A_{VOL}$	Large-Signal Voltage Gain	$R_L = 2k$ , $V_{OUT} = \pm 2V$	<b>60</b>	71		dB
		$R_L = 200\Omega$ , $V_{OUT} = \pm 2V$	<b>60</b>	71		dB
$V_{OUT}$	Maximum Output Voltage Swing	positive, $R_L = 2k\Omega$	+3.3 <b>+3.0</b>	3.5		V V
		negative, $R_L = 2k\Omega$		-3.5	-3.3 <b>-3.0</b>	V V
		positive, $R_L = 200\Omega$	+3.0 <b>+2.75</b>	3.2		V V
		negative, $R_L = 200\Omega$		-2.8	-2.45 <b>-2.2</b>	V V
GBW	Gain-Bandwidth Product	$R_L = 1k\Omega$		125		MHz
BW	-3dB Bandwidth	$A_V = 1$ , $R_L = 100\Omega$		192		MHz
SR	Slew Rate			230		V/ $\mu s$
	Crosstalk	$f = 1MHz$ , between op amp A and B or B and C		56		dB
		$f = 1MHz$ , between op amp A and C		72		dB
$I_{GND}$	Short-Circuit Output Current	source		72		mA
		sink		25		mA
$I_{GND}$	Supply Current per Op Amp			2.4	3.5 <b>4.1</b>	mA mA

**Electrical Characteristics**

$V_{V+} = +9V$ ,  $V_{V-} = -9V$ ,  $V_{CM} = 0V$ ,  $V_{OUT} = 0V$ ;  $R_L = 10M\Omega$ ;  $T_J = 25^\circ C$ , **bold** values indicate  $-40^\circ C \leq T_J \leq +85^\circ C$ ; unless noted

Symbol	Parameter	Condition	Min	Typ	Max	Units
$V_{OS}$	Input Offset Voltage			1	<b>15</b>	mV
$V_{OS}$	Input Offset Voltage Temperature Coefficient			4		$\mu V/^\circ C$

Symbol	Parameter	Condition	Min	Typ	Max	Units
$I_B$	Input Bias Current			3.5	5.5 <b>9</b>	$\mu A$ $\mu A$
$I_{OS}$	Input Offset Current			0.05	<b>3</b>	$\mu A$
$V_{CM}$	Input Common-Mode Range	CMRR > 60dB	-7.25		+7.25	V
CMRR	Common-Mode Rejection Ratio	$-6.5V < V_{CM} < 6.5V$	70 <b>60</b>	98		dB dB
$A_{VOL}$	Large-Signal Voltage Gain	$R_L = 2k\Omega, V_{OUT} = \pm 6V$	<b>60</b>	73		dB
$V_{OUT}$	Maximum Output Voltage Swing	positive, $R_L = 2k\Omega$	+7.2 <b>+6.8</b>	+7.4		V V
		negative, $R_L = 2k\Omega$		-7.4	-7.2 <b>-6.8</b>	V V
GBW	Gain-Bandwidth Product	$R_L = 1k\Omega$		135		MHz
SR	Slew Rate			270		V/ $\mu s$
	Crosstalk	$f = 1MHz$ , between op amp A and B or B and C		56		dB
		$f = 1 MHz$ , between op amp A and C		72		dB
$I_{GND}$	Short-Circuit Output Current	source		90		mA
		sink		32		mA
$I_{GND}$	Supply Current per Op Amp			2.5	3.7 <b>4.3</b>	mA mA

**Note 1.** Exceeding the absolute maximum rating may damage the device.

**Note 2.** The device is not guaranteed to function outside its operating rating.

**Note 3.** Devices are ESD sensitive. Handling precautions recommended. Human body model, 1.5k in series with 100pF.

**Note 4.** Exceeding the maximum differential input voltage will damage the input stage and degrade performance (in particular, input bias current is likely to increase).

### Test Circuits

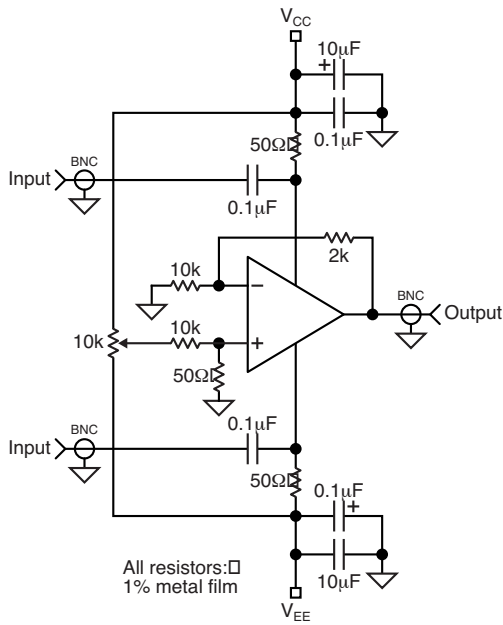

**PSRR vs. Frequency**

All resistors: □  
1% metal film

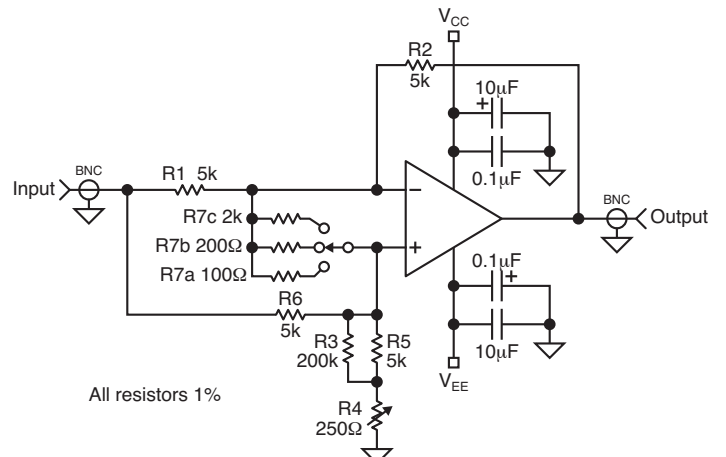

All resistors 1%

$$V_{OUT} = V_{ERROR} \left( 1 + \frac{R2}{R1} + \frac{R2 + R5 + R4}{R7} \right)$$

**CMRR vs. Frequency**

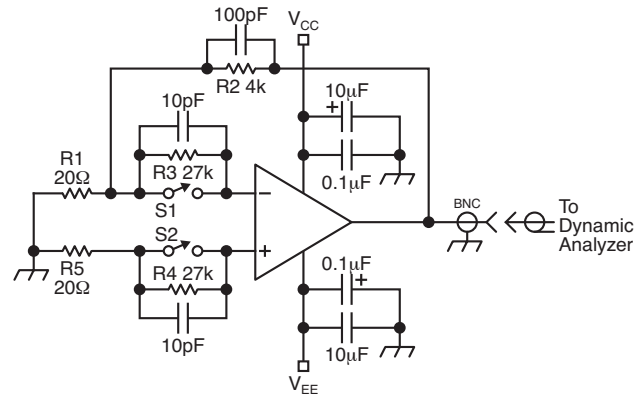
**Noise Measurement**

# Electrical Characteristics

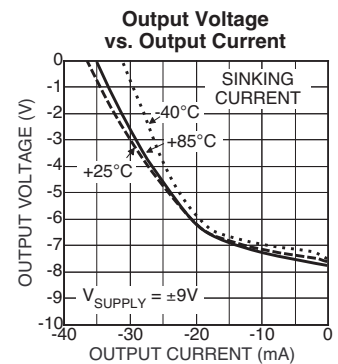
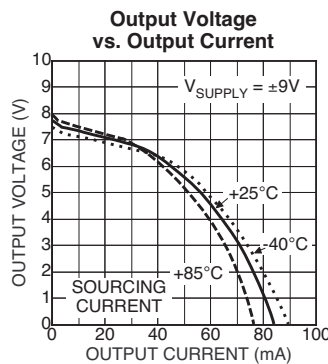
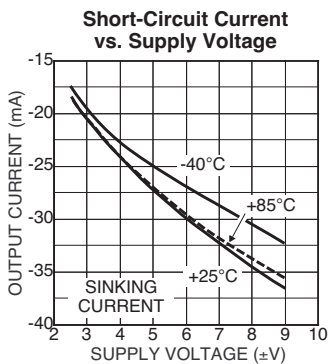
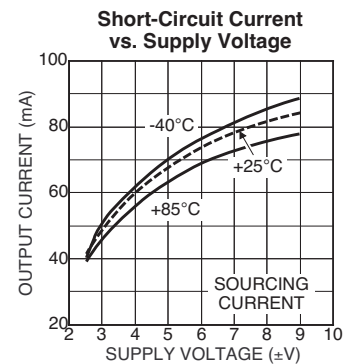
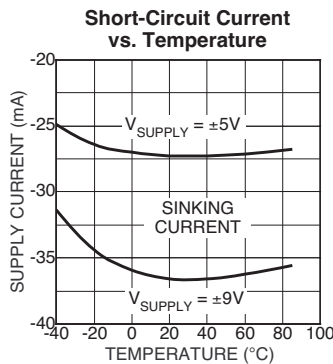
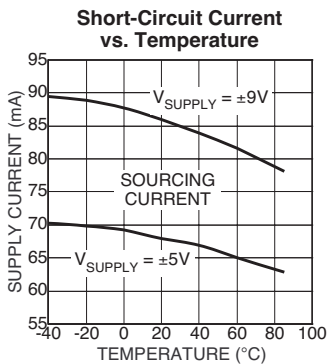
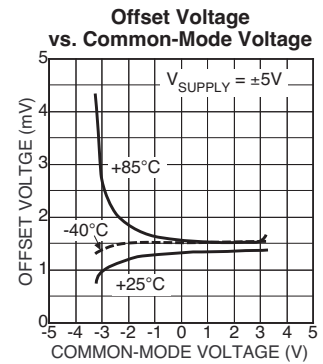
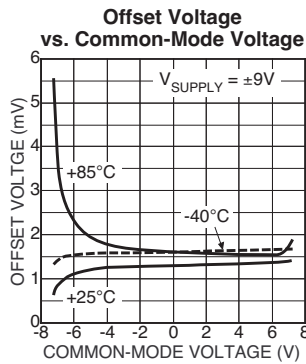
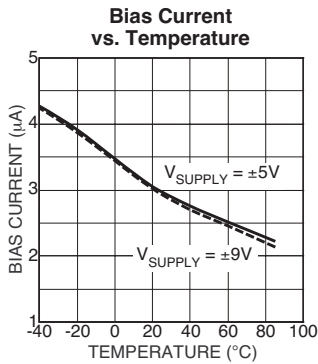
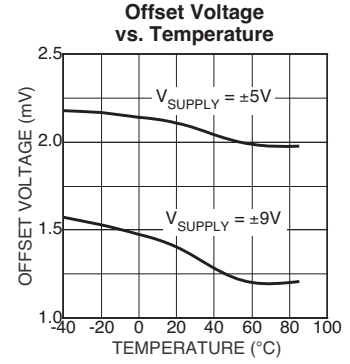
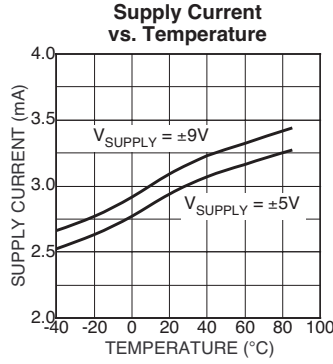
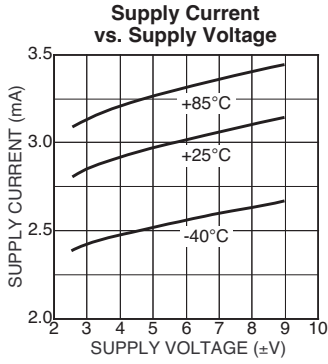

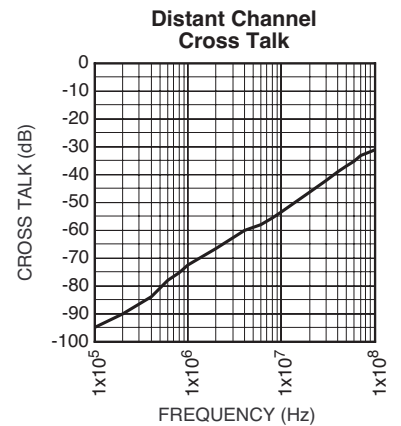
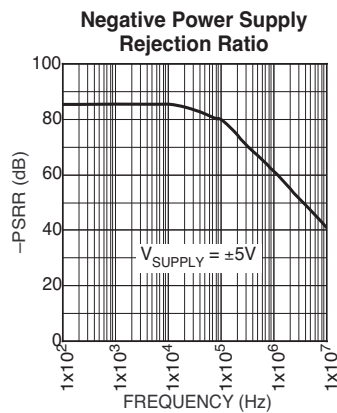
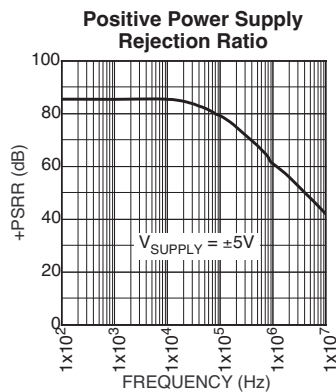
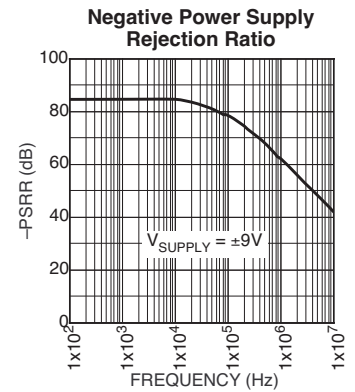
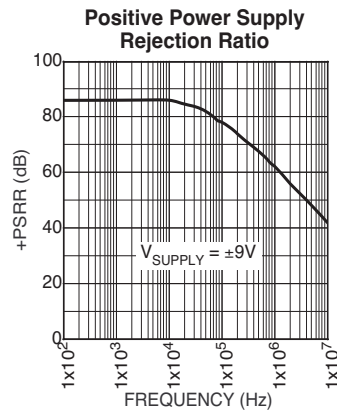
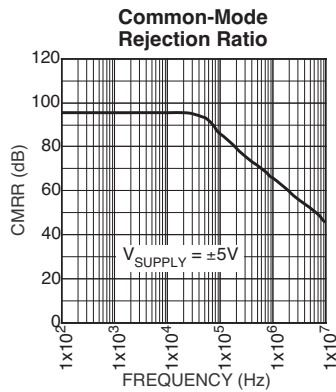
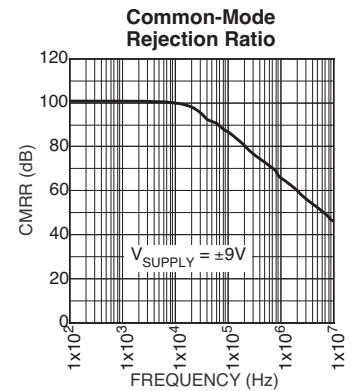
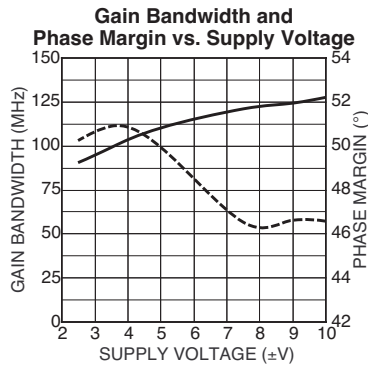
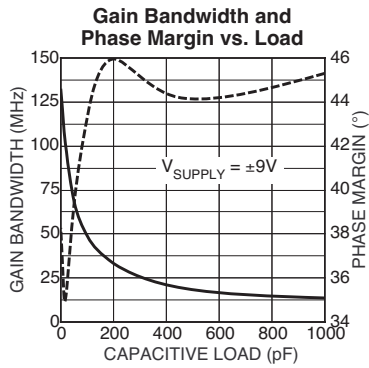
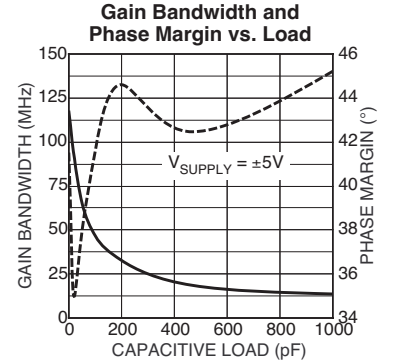
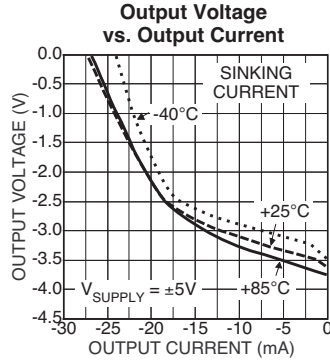
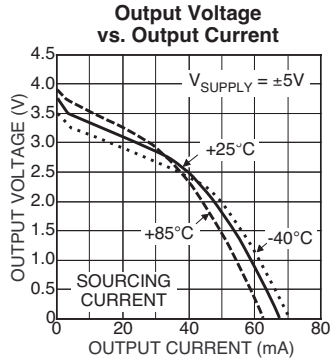

**Closed-Loop Frequency Response Test Circuit**

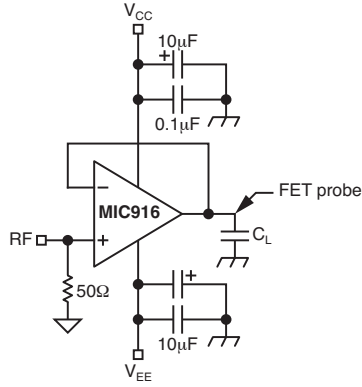

**Adjacent Channel Cross Talk**

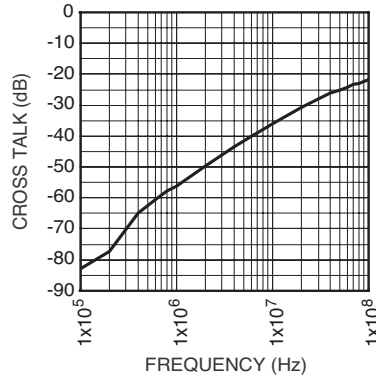

**Closed-Loop Frequency Response**

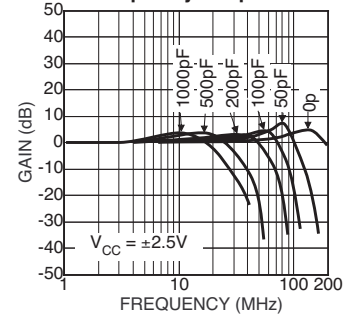

**Open-Loop Frequency Response**

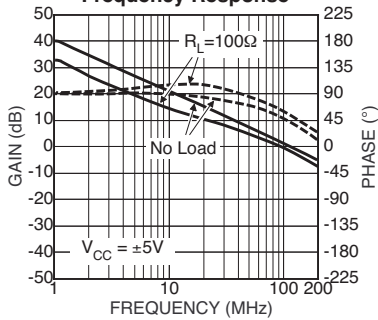

**Closed-Loop Frequency Response**

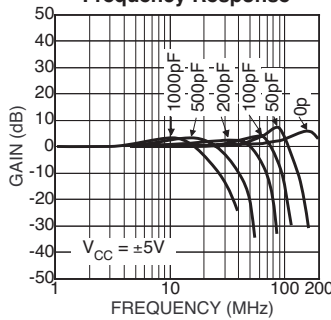

**Open-Loop Frequency Response**

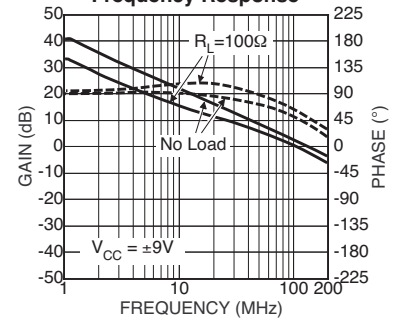

**Voltage Noise**

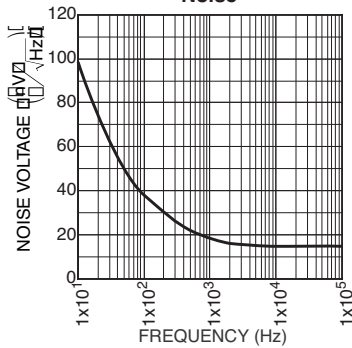

**Positive Slew Rate**

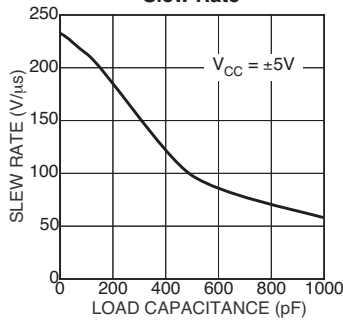

**Negative Slew Rate**

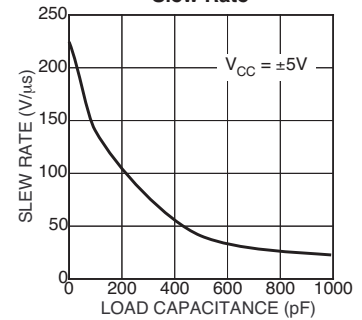

**Current Noise**

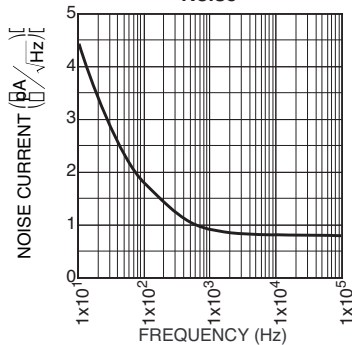

**Positive Slew Rate**

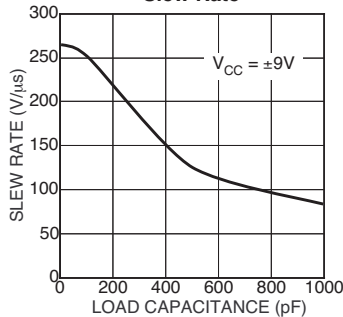

**Negative Slew Rate**

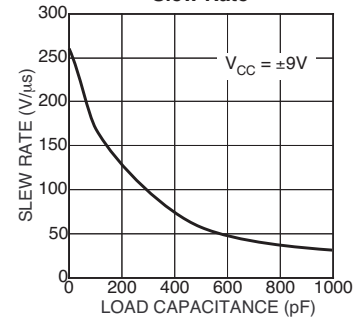



Small-Signal  
Pulse Response

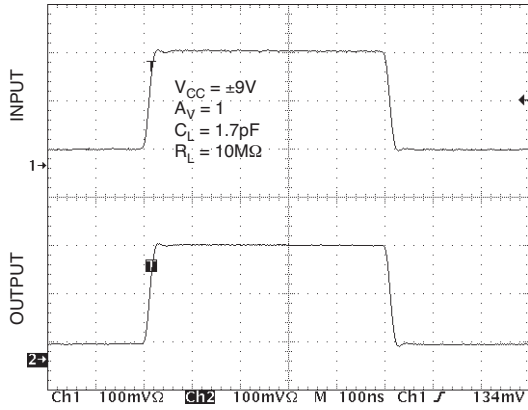

Small-Signal  
Pulse Response

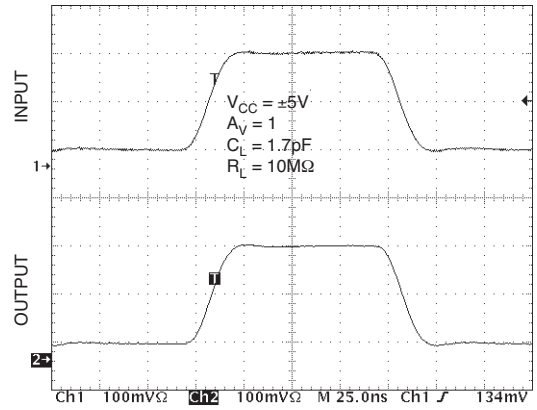

Small-Signal  
Pulse Response

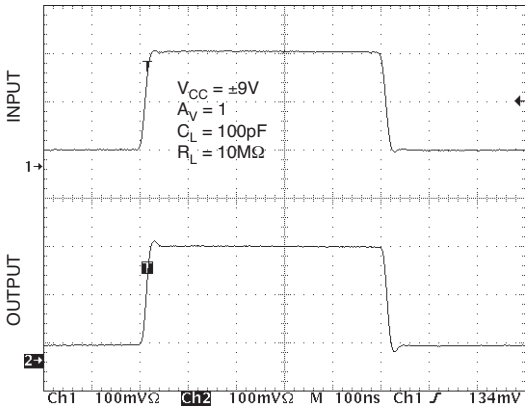

Small-Signal  
Pulse Response

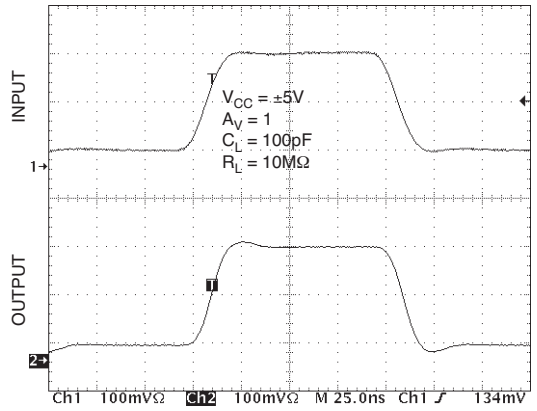

Small-Signal  
Pulse Response

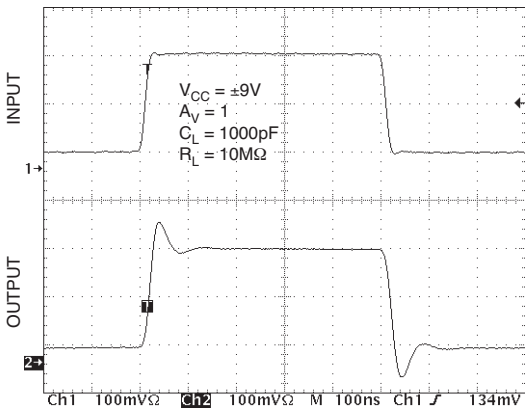

Small-Signal  
Pulse Response

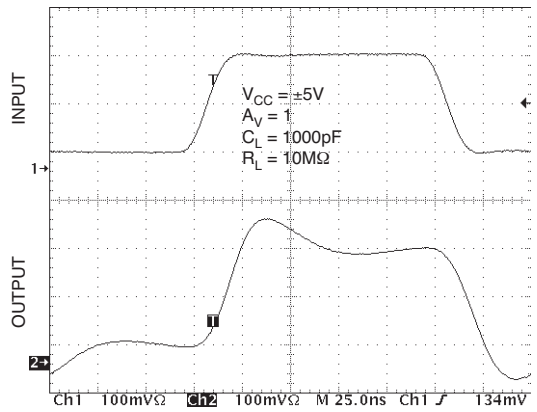

Large-Signal  
Pulse Response

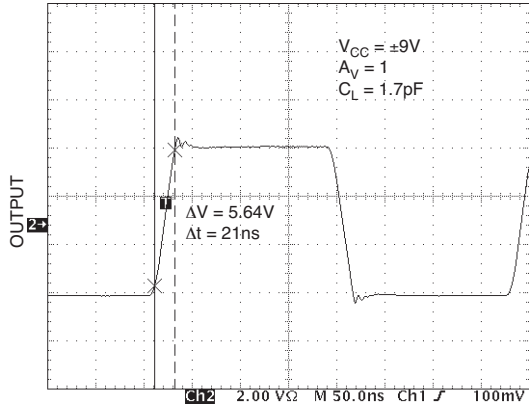

Large-Signal  
Pulse Response

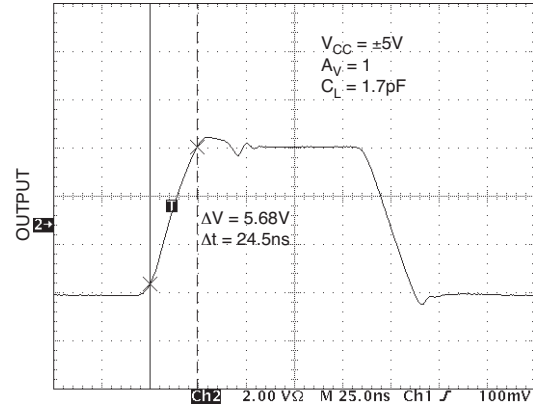

Large-Signal  
Pulse Response

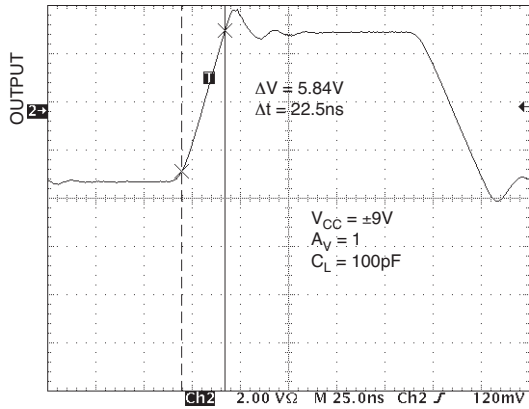

Large-Signal  
Pulse Response

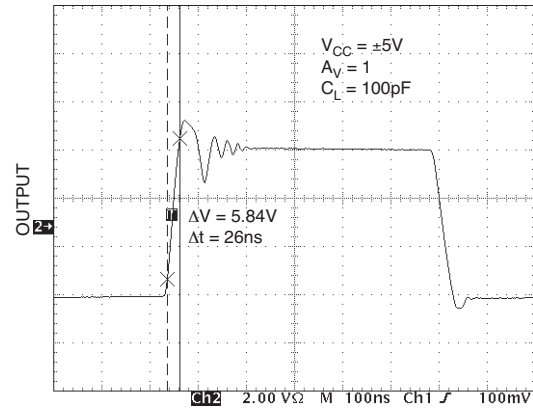

Large-Signal  
Pulse Response

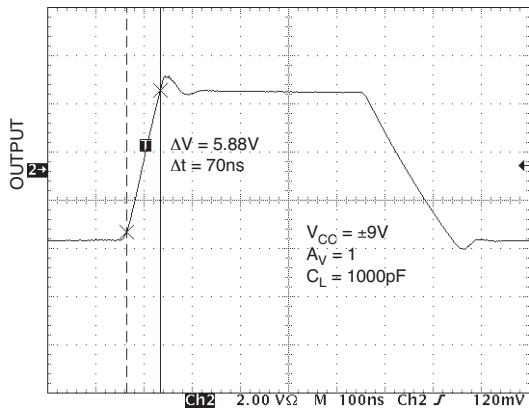

Large-Signal  
Pulse Response

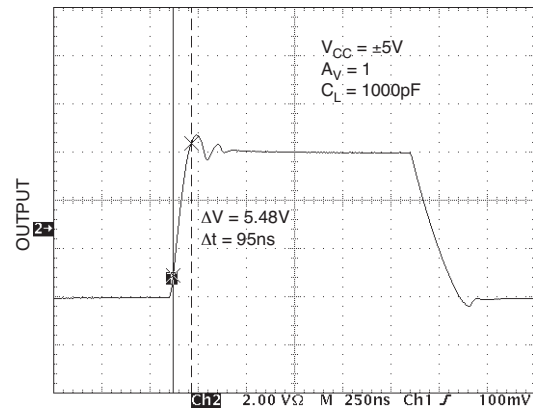

## Applications Information

The MIC916 is a high-speed, voltage-feedback operational amplifier featuring very low supply current and excellent stability. This device is unity gain stable and capable of driving high capacitance loads.

### Driving High Capacitance

The MIC916 is stable when driving any capacitance (see "Typical Characteristics: Gain Bandwidth and Phase Margin vs. Load Capacitance") making it ideal for driving long coaxial cables or other high-capacitance loads.

Phase margin remains constant as load capacitance is increased. Most high-speed op amps are only able to drive limited capacitance.

Note: increasing load capacitance does reduce the speed of the device (see "Typical Characteristics: Gain Bandwidth and Phase Margin vs. Load"). In applications where the load capacitance reduces the speed of the op amp to an unacceptable level, the effect of the load capacitance can be reduced by adding a small resistor (<100Ω) in series with the output.

### Feedback Resistor Selection

Conventional op amp gain configurations and resistor selection apply, the MIC916 is NOT a current feedback device. Resistor values in the range of 1k to 10k are recommended.

### Layout Considerations

All high speed devices require careful PCB layout. The high stability and high PSRR of the MIC916 make this op amp easier to use than most, but the following guidelines should be observed: Capacitance, particularly on the two inputs pins will degrade performance; avoid large copper traces to the inputs. Keep the output signal away from the inputs and use a ground plane.

It is important to ensure adequate supply bypassing capacitors are located close to the device.

## Power Supply Bypassing

Regular supply bypassing techniques are recommended. A 10μF capacitor in parallel with a 0.1μF capacitor on both the positive and negative supplies are ideal. For best performance all bypassing capacitors should be located as close to the op amp as possible and all capacitors should be low ESL (equivalent series inductance), ESR (equivalent series resistance). Surface-mount ceramic capacitors are ideal. **All V– pins must be externally shorted together.**

## Thermal Considerations

It is important to ensure the IC does not exceed the maximum operating junction (die) temperature of 85°C. The part can be operated up to the absolute maximum temperature rating of 125°C, but between 85°C and 125°C performance will degrade, in particular CMRR will reduce.

A MIC916 with no load, dissipates power equal to the quiescent supply current \* supply voltage

$$P_{D(\text{no load})} = (V_{V+} - V_{V-}) I_S$$

When a load is added, the additional power is dissipated in the output stage of the op amp. The power dissipated in the device is a function of supply voltage, output voltage and output current.

$$P_{D(\text{output stage})} = (V_{V+} - V_{OUT}) I_{OUT}$$

$$\text{Total Power Dissipation} = P_{D(\text{no load})} + P_{D(\text{output stage})}$$

Ensure the total power dissipated in the device is no greater than the thermal capacity of the package. The QSOP-16 package has a thermal resistance of 260°C/W.

$$\text{Max. Allowable Power Dissipation} = \frac{T_{J(\text{max})} - T_{A(\text{max})}}{TBD} W$$

Package Information

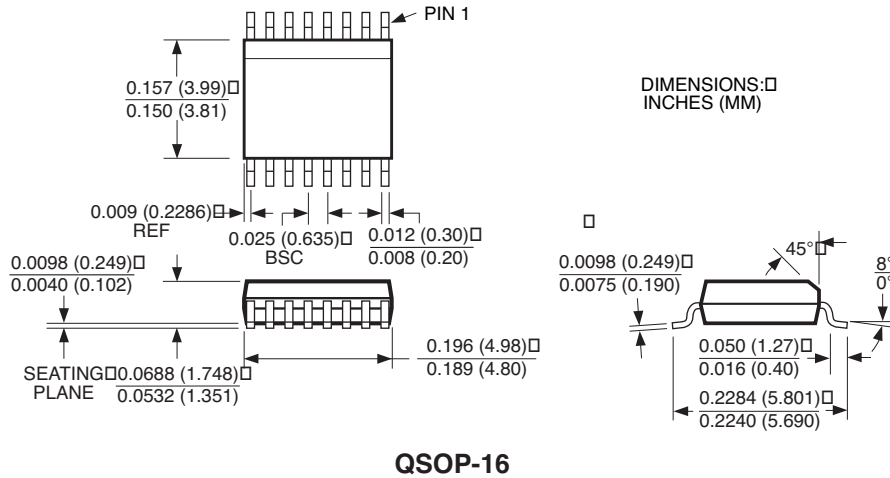

**MICREL INC. 2180 FORTUNE DRIVE SAN JOSE, CA 95131 USA**

TEL + 1 (408) 944-0800 FAX + 1 (408) 474-1000 WEB <http://www.micrel.com>

This information furnished by Micrel in this data sheet is believed to be accurate and reliable. However no responsibility is assumed by Micrel for its use. Micrel reserves the right to change circuitry and specifications at any time without notification to the customer.

Micrel Products are not designed or authorized for use as components in life support appliances, devices or systems where malfunction of a product can reasonably be expected to result in personal injury. Life support devices or systems are devices or systems that (a) are intended for surgical implant into the body or (b) support or sustain life, and whose failure to perform can be reasonably expected to result in a significant injury to the user. A Purchaser's use or sale of Micrel Products for use in life support appliances, devices or systems is a Purchaser's own risk and Purchaser agrees to fully indemnify Micrel for any damages resulting from such use or sale.

© 2000 Micrel Incorporated