

## Low Bias Current, Low Power JFET Input Operational Amplifier

### Features

- Ultra Low Bias Current ..... 250fA
- Low Power Supply Current ..... 0.8mA
- Low Offset Voltage ..... 0.5mV Max.
- Unity Gain Bandwidth ..... 2MHz
- Slew Rate ..... 7V/ $\mu$ s

### Description

The Harris HA-5180 is an ultra low input bias current, JFET input, monolithic operational amplifier which also features low power, low offset voltage and excellent AC characteristics. Employing FET/Bipolar construction coupled with dielectric isolation this operational amplifier offers the lowest input bias currents (250fA typical) available in any monolithic operational amplifier. The HA-5180 has another unique feature in which the offset bias current may be nulled by externally adjusting the offset voltage.

The HA-5180 also offers excellent AC performance not previously available in similar hybrid or monolithic op amp designs. The 2MHz bandwidth and 7V/ $\mu$ s rate of the HA-5180 extends the bandwidth and speed for applications such as very low drift sample and hold

### Applications

- Electrometer Amplifier Designs
- Photo Current Detectors
- Precision, Long-Term Integrators
- Low Drift Sample & Hold Circuits
- Very High Impedance Buffers
- High Impedance Biological Micro Probes
- Refer to Application Note 555

amplifiers and photo-current detectors. Other applications include use in electrometer designs, pH/Ion sensitive electrodes, low current oxygen sensors, long term precision integrators and very high impedance buffer measurement designs.

The HA-5180 is packaged in an 8 pin (TO-99) Metal Can and an 8 lead Mini-DIP and is pin compatible with most existing op amp configurations. The case of the TO-99 package is internally connected to pin 8 so that it may be connected to the same potential as the input. This feature helps minimize stray leakage to the case, helps shield the amplifier from external noise and reduces common mode input capacitance. For military grade product, refer to the HA-5180/883 data sheet.

### Pinouts

HA7-5180 (CERAMIC MINI-DIP)  
TOP VIEW

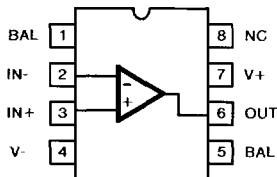

HA2-5180 (TO-99 METAL CAN)  
TOP VIEW

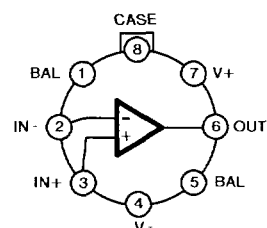

### Schematic

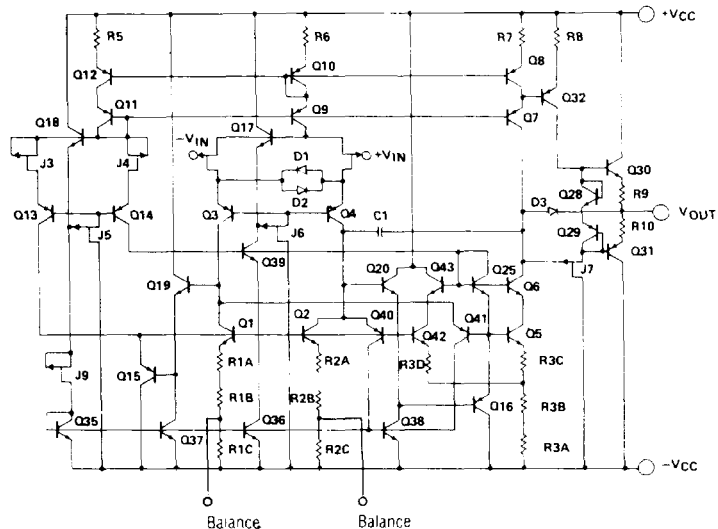

# Specifications HA-5180

## Absolute Maximum Ratings (Note 1)

$T_A = +25^\circ\text{C}$ Unless Otherwise Specified	
Voltage Between V+ and V- Terminals	40V
Differential Input Voltage	$\pm 40\text{V}$
Output Short Circuit Duration	Indefinite
Power Dissipation (Note 2)	300mW

## Operating Temperature Ranges

HA-5180-2	$-55^\circ\text{C} \leq T_A \leq +125^\circ\text{C}$
HA-5180-5	$0^\circ\text{C} \leq T_A \leq +75^\circ\text{C}$
Storage Temperature Range	$-65^\circ\text{C} \leq T_A \leq +150^\circ\text{C}$

## Electrical Specifications $V_+ = +15\text{V}$ , $V_- = -15\text{V}$ , Unless Otherwise Specified.

PARAMETER	TEMP	HA-5180-2 -55°C to +125°C			HA-5180-5 0°C to +75°C			UNITS
		MIN	TYP	MAX	MIN	TYP	MAX	
<b>INPUT CHARACTERISTICS</b>								
Offset Voltage	+25°C	-	1	3	-	1	3	mV
	Full	-	-	4	-	-	4	mV
Average Offset Voltage Drift	Full	-	5	-	-	5	-	$\mu\text{V}/^\circ\text{C}$
Bias Current (Note 3)	+25°C	-	250	1000	-	250	1000	fA
	Full	-	100	500	-	6	30	pA
Offset Current (Note 3)	+25°C	-	30	200	-	30	200	fA
	Full	-	6	30	-	1	5	pA
Common Mode Range	Full	$\pm 10$	$\pm 12$	-	$\pm 10$	$\pm 12$	-	V
Differential Input Resistance	+25°C	-	1012	-	-	1012	-	$\Omega$
Input Capacitance	+25°C	-	5	-	-	5	-	pF
Input Noise Voltage, 0.1Hz to 10Hz	+25°C	-	5	-	-	5	-	$\mu\text{V}_{\text{p-p}}$
Input Noise Voltage Density								
$f_0 = 10\text{Hz}$	+25°C	-	200	-	-	200	-	$\text{nV}/\sqrt{\text{Hz}}$
$f_0 = 100\text{Hz}$	+25°C	-	120	-	-	120	-	$\text{nV}/\sqrt{\text{Hz}}$
$f_0 = 1000\text{Hz}$	+25°C	-	70	-	-	70	-	$\text{nV}/\sqrt{\text{Hz}}$
Input Noise Current ( $f = 1\text{kHz}$ )	+25°C	-	0.01	-	-	0.01	-	$\text{pA}/\sqrt{\text{Hz}}$
<b>TRANSFER CHARACTERISTICS</b>								
Large Signal Voltage Gain (Notes 4)	+25°C	200K	1M	-	200K	1M	-	V/V
	Full	150K	-	-	150K	-	-	V/V
Common Mode Rejection Ratio (Note 5)	Full	90	110	-	90	110	-	dB
Closed Loop Bandwidth ( $A_{\text{VCL}} = +1$ )	+25°C	-	2	-	-	2	-	MHz
<b>OUTPUT CHARACTERISTICS</b>								
Output Voltage Swing (Note 6)	+25°C	$\pm 10$	$\pm 12$	-	$\pm 10$	$\pm 12$	-	V
	Full	$\pm 10$	-	-	$\pm 10$	-	-	V
Full Power Bandwidth (Note 7)	+25°C	-	110	-	-	110	-	kHz
Output Current (Note 8)	+25°C	$\pm 10$	$\pm 15$	-	$\pm 10$	$\pm 15$	-	mA
Output Resistance (Note 9)	+25°C	-	25	-	-	25	-	$\Omega$
<b>TRANSIENT RESPONSE</b>								
Overshoot	+25°C	-	30	50	-	30	50	%
Rise Time	+25°C	-	75	-	-	75	-	ns
Slew Rate	+25°C	4	7	-	4	7	-	V/ $\mu\text{s}$
Settling Time (Note 10)	+25°C	-	2	-	-	2	-	$\mu\text{s}$
<b>POWER SUPPLY CHARACTERISTICS</b>								
Supply Current	Full	-	0.7	1	-	0.8	1	mA
Power Supply Rejection Ratio (Note 11)	Full	85	105	-	85	105	-	dB

### NOTES:

1. Absolute Maximum Ratings are limiting values applied individually beyond which the serviceability of the circuit may be impaired. Functional operation under any of these conditions is not necessarily implied.
2. Derate at 6.9 mW/°C for operation at ambient temperatures above +75°C.
3. This parameter is guaranteed by design and is not 100% tested.
4.  $V_{\text{OUT}} = \pm 10\text{V}$ ;  $R_L = 2\text{K}$ . Gain dB =  $20 \log_{10} A_V$ .
5.  $\Delta V_{\text{CM}} = \pm 10\text{V D.C.}$
6.  $R_L = 2\text{K}$ .
7.  $R_L = 2\text{K}$ ,  $V_{\text{PEAK}} = 10\text{V}$ ; Full power bandwidth guaranteed based on slew rate measurement using  $\text{FPBW} = \frac{\text{SLEW RATE}}{2\pi V_{\text{PEAK}}}$
8.  $V_{\text{OUT}} = \pm 10\text{V}$ .
9. Output resistance specified under open loop conditions ( $f = 100\text{Hz}$ ).
10. Settling time is specified to 0.1% of final value for a 10V output step and  $A_V = -1$ .
11.  $\Delta V_{\text{SUPPLY}} = \pm 10\text{V D.C. to } \pm 20\text{V D.C.}$

**Typical Performance Curves**

**SMALL SIGNAL BANDWIDTH AND PHASE MARGIN vs. LOAD CAPACITANCE**

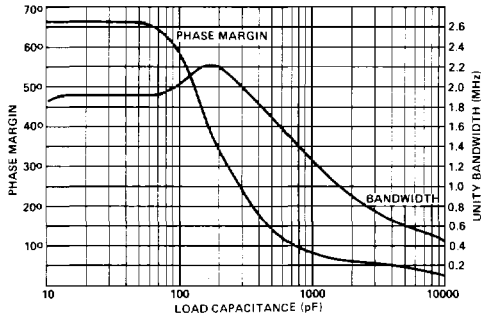

**SUPPLY CURRENT vs. TEMPERATURE**

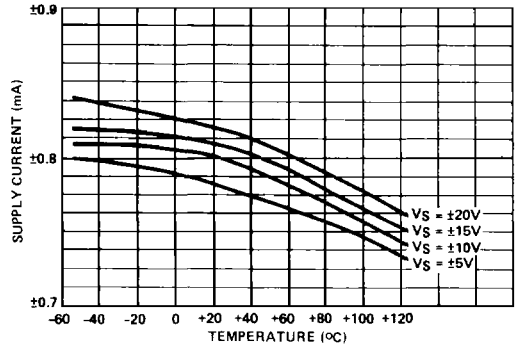

**NORMALIZED AC PARAMETERS vs. TEMPERATURE**

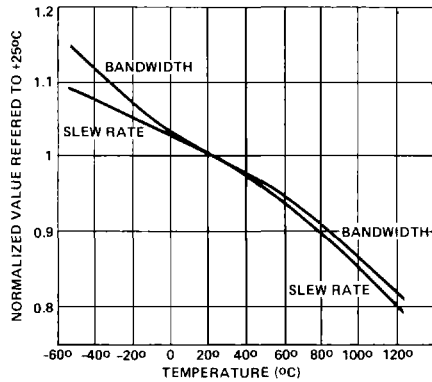

**INPUT VOLTAGE NOISE vs. FREQUENCY**

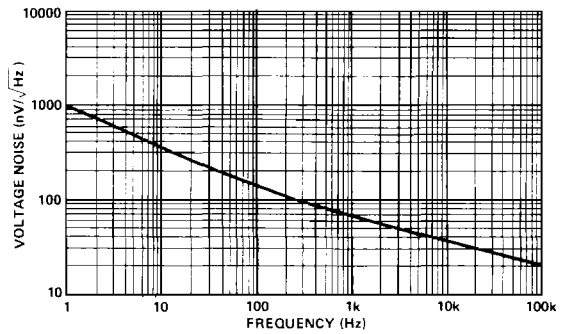

**PSRR vs. FREQUENCY**

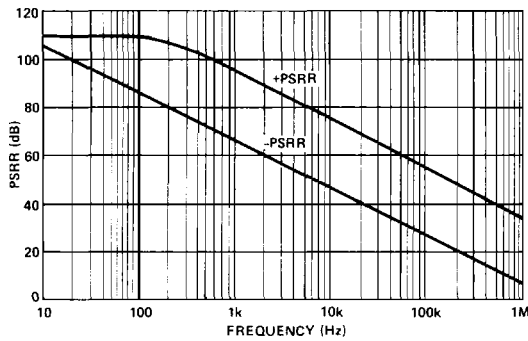

**CMRR vs. FREQUENCY**

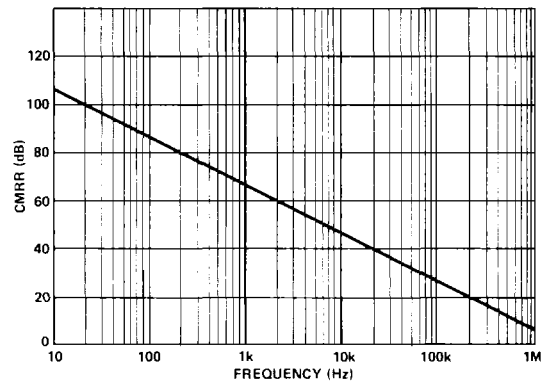

Typical Performance Curves (Continued)

SETTLING TIME FOR VARIOUS OUTPUT STEP VOLTAGES

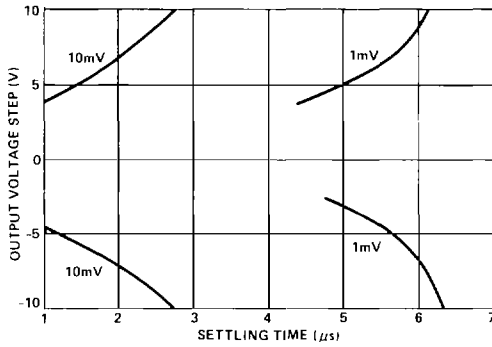

BIAS CURRENT vs. TEMPERATURE

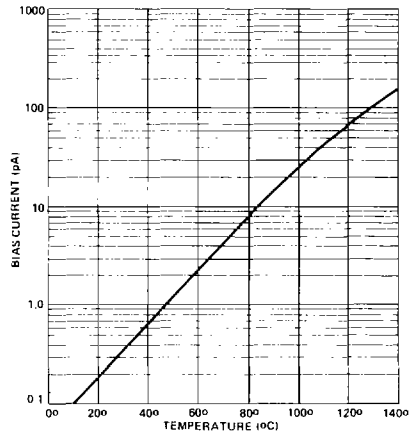

OPEN LOOP FREQUENCY RESPONSE

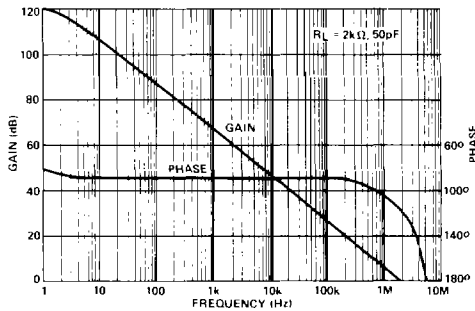

OUTPUT VOLTAGE SWING vs. LOAD RESISTANCE

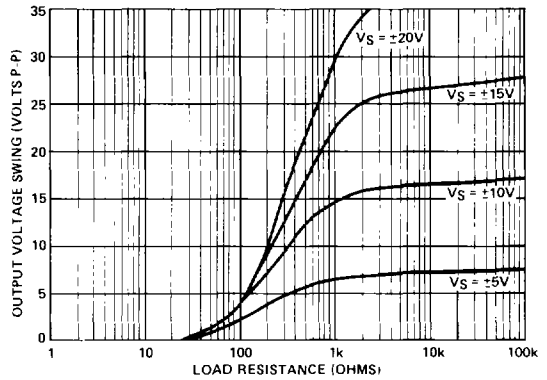

OUTPUT VOLTAGE SWING vs. FREQUENCY

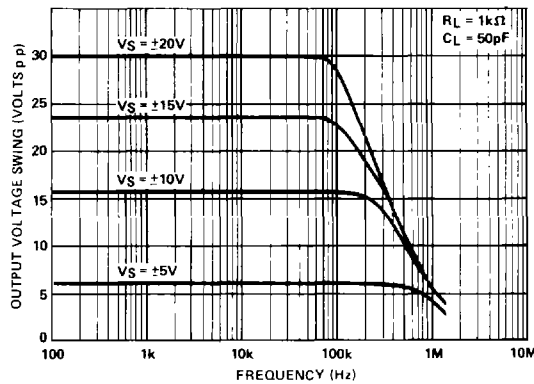

## Typical Applications

The HA-5180 offers one of the lowest input bias currents of any monolithic operational amplifier and is ideal for use in applications for measuring signals from very high impedance or very low current sources. To fully utilize the capabilities of the HA-5180, care should be taken to minimize noise pickup and current leakage paths with the use of shielding and guarding techniques and by placing the device as close as possible to the signal source. The small size and low quiescent current (possible battery operation) of the HA-5180 allows easy installation at the signal source or inside a probe. The HA-5180 is internally compensated and is capable of driving long signal cables which have several hundred pF capacitive loading.

If it is not possible to place the HA-5180 very close to the signal source, then the use of shielded coaxial cable will offer the best isolation of the high impedance signal line from external noise sources. However, the effects of leakage, capacitance and vibrational noise should be taken into account when using coaxial cables. Leakage can be minimized by using cables with very high insulation resistance (such as polyethylene or Virgin Teflon). For example, the current to voltage converter circuit (as shown in Figure 1) will eliminate leakage across the insulation of the cable by forcing the signal line to the same potential as the shield. This circuit also provides fast response to input signals because the cable capacitance is never forced to be charged or discharged. However, the cable capacitance directly increases the input capacitance of the circuit and could cause the circuit to become unstable; if so, adding capacitance across  $R_f$  will stabilize the circuit again. Leakage can also be reduced in the high-impedance non-inverting configuration (see Figure 2) by bootstrapping the shield to the same potential as the signal source instead of ground. If low closed-loop gains are used, the non-inverting configuration could also become unstable due to the positive feedback to the input through the cable capacitance. One method of compensating this circuit is to place a small (low leakage) capacitor from the input to ground. This technique will also reduce the effective capacitance presented to the signal source. When large closed-loop gains and/or long cable lengths are used, a buffer should be added to the circuit to drive the shield.

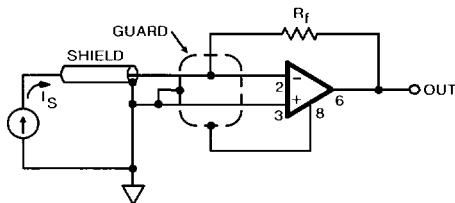

FIGURE 1. CURRENT TO VOLTAGE CONVERTER

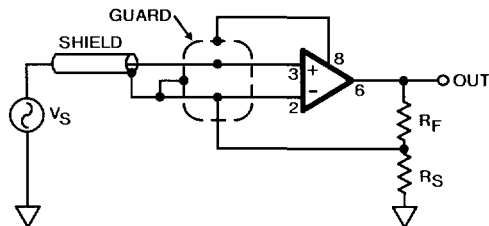

FIGURE 2. VERY HIGH IMPEDANCE NON-INVERTING AMPLIFIER

When using coaxial cable with the HA-5180 the cable should be kept as rigid and vibration free as possible. Frictional movement of the shield over the insulation can generate electrical charge which is picked up by the high impedance signal line as noise. Movement and bending of the cable can also cause charge movement due to small changes in cable capacitance and capacitance to surrounding objects. Another source of noise currents is that which is generated by the movement of a conductor in a magnetic field.

For lowest leakage at the device inputs either use a teflon IC socket or connect the signal line to the HA-5180 inputs using teflon standoffs. A guard ring, as shown in Figure 3, applied to both sides of the pc board and bootstrapped to the same potential as the input signal will minimize leakage paths across the pc board. Pin 8 of the TO-99 can, which is internally tied to the case, should also be tied to the bootstrap potential to help minimize noise pickup and leakage currents across the package insulation. This technique will also reduce common mode input capacitance.

Cleanliness of circuit boards and components is also important for achieving low leakage currents. Printed circuit boards and components should be thoroughly cleaned by using a low residue solvent such as TMC Freon, rinsed by deionized water and dried with nitrogen. The circuit board should be protected from high contamination and high humidity environments. A good quality conformal coating with low dielectric absorption provides the best protection from humidity and contamination.

Input protection is generally not necessary when designing with the HA-5180. Many electrometer type devices, especially CMOS, require elaborate zener protection schemes which may compromise overall performance. The Harris dielectric isolation process and JFET input design enables the HA-5180 to withstand input signals several volts beyond either supply and large differential signals equal to the rail-to-rail supply voltage without damage or degradation of performance.

For more information see Application Note 555.

Typical Applications (Continued)

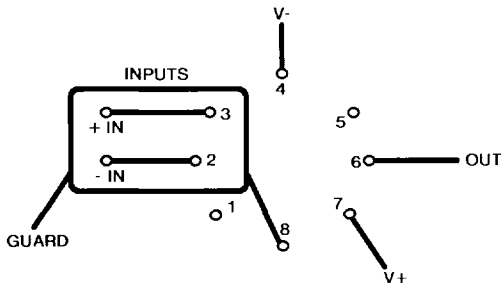

FIGURE 3. GUARD RING EXAMPLE

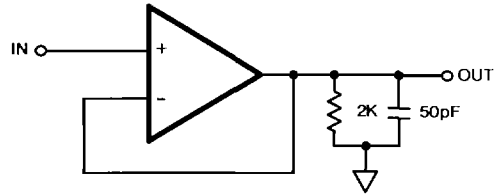

FIGURE 4. SLEW RATE AND TRANSIENT RESPONSE TEST CIRCUIT

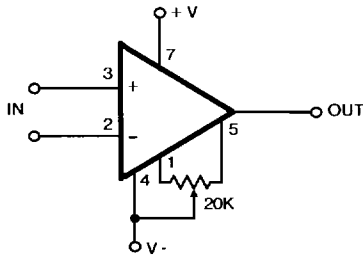
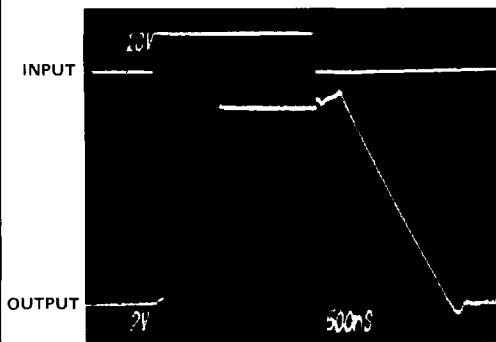

FIGURE 5. SUGGESTED OFFSET ADJUSTMENT CIRCUIT

LARGE SIGNAL RESPONSE

Vertical Scale (Volts: 5V/Div. Input)  
 (Volts: 2V/Div. Output)  
 Horizontal Scale (Time: 500ns/Div.)



SMALL SIGNAL RESPONSE

Vertical Scale (Volts: 100mV/Div. Input)  
 (Volts: 50mV/Div. Output)  
 Horizontal Scale (Time: 500ns/Div.)

