

MAXIM

±15 Volt Chopper Stabilized Operational Amplifier

MAX420/421/422/423

General Description

The MAX420, 421, 422, and 423 are a series of ±15V CMOS chopper-stabilized amplifiers, designed for high accuracy amplification, signal conditioning and instrumentation applications. These devices offer input offset and drift specification superior to previous "precision" bipolar amplifiers and monolithic choppers. The maximum offset is 5.0μV while the guaranteed drift limit is 0.05μV/°C.

The combination of ±15 volt operation, low power, and standard op-amp pin configuration allows these devices to virtually "plug-in" replace conventional lower-performance amplifiers. The only additional components required are two external capacitors. A wide input voltage range specification, that includes the negative supply, allows for the amplification of signals including ground in single-supply applications.

The MAX420 (8 pin) and MAX421 (14 pin) have a maximum supply current of 2mA. The MAX422 (8 pin) and MAX 423 (14 pin) are low power amplifiers with a maximum current of 0.5mA.

Applications

- Precision Amplifiers
- Signal Conditioning for:
 - Thermocouples
 - Strain Gauges, Load Cells
 - Platinum Temperature Sensors
 - Thermistors, Bridges
- High Accuracy Data Acquisition
- D.C. Stabilization of Amplifiers and Systems

Typical Operating Circuit

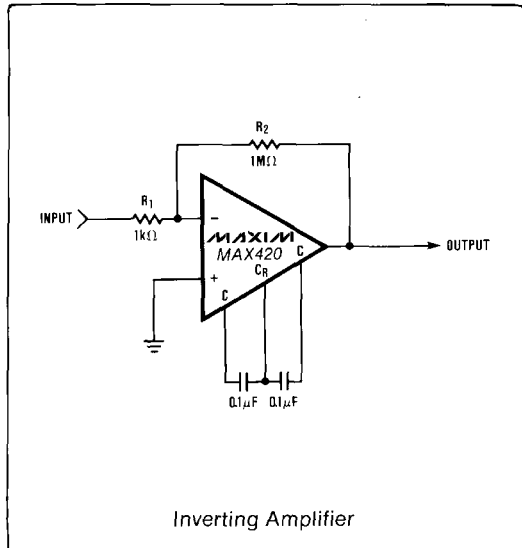

Features

- ◆ 5μV Max Offset Voltage
- ◆ ±15V Supply Operation
- ◆ Input Voltage Range: +11V to -15V
- ◆ Low Input Noise: 0.3μV_{p-p} (DC - 1Hz)
- ◆ High Gain, CMRR, PSRR: 120dB
- ◆ Low Power CMOS Design: 0.5mA Max Supply Current (MAX422/423)
- ◆ Low Input Bias Current: 30pA Max

Ordering Information

PART	TEMP. RANGE	PACKAGE
MAX420CPA	0°C to +70°C	8 Lead Plastic DIP
MAX420EPA	-40°C to +85°C	8 Lead Plastic DIP
MAX420MTV	-55°C to +125°C	TO-99 Metal Can
MAX421CPD	0°C to +70°C	14 Lead Plastic DIP
MAX421CWE	0°C to +70°C	16 Lead Small Outline
MAX421C/D	0°C to +70°C	Dice
MAX421EPD	-40°C to +85°C	14 Lead Plastic DIP
MAX421MJD	-55°C to +125°C	14 Lead CERDIP

(Ordering information continued on last page)

Pin Configurations

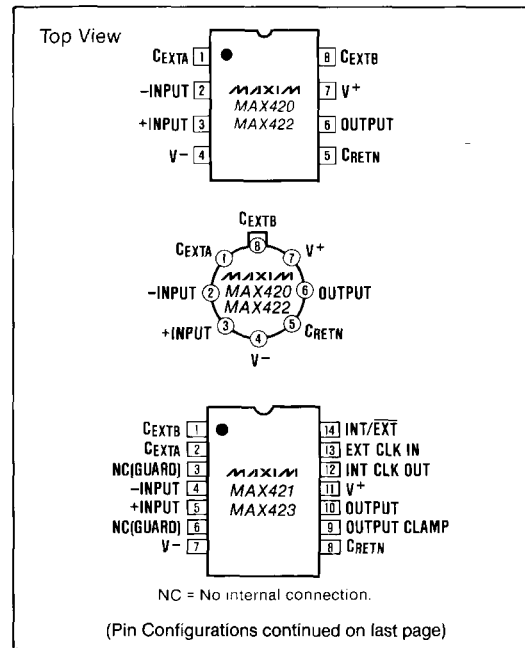

±15 Volt Chopper Stabilized Operational Amplifier

ABSOLUTE MAXIMUM RATINGS

Total Supply Voltage (V ⁺ to V ⁻)	36V	Current Into Any Pin	10mA
Input Voltage	(V ⁺ + 0.3) to (V ⁻ - 0.3) V	Continuous Total Power Dissipation (T _A = +25°C)	
Storage Temperature Range	-65°C to +160°C	CERDIP Package	500mW
Operating Temperature Range	See Note 1	Plastic Package	375mW
Lead Temperature (Soldering, 10 sec)	+300°C	TO-99	250mW
Voltage on Oscillator Control Pins	V ⁺ to V ⁻		
Duration of Output Short Circuit	Indefinite		

Stresses above those listed under "Absolute Maximum Ratings" may cause permanent damage to the device. These are stress ratings only and functional operation of the device at these or any other conditions above those indicated in the operational sections of the specifications is not implied. Exposure to absolute maximum rating conditions for extended periods may affect device reliability.

ELECTRICAL CHARACTERISTICS MAX420, MAX421

(V⁺ = +15V, V⁻ = -15V, T_A = +25°C. Test circuit unless noted.)

PARAMETER	SYMBOL	CONDITIONS	MIN.	TYP.	MAX.	UNITS
Input Offset Voltage	V _{OS}	T _A = +25°C	C	±1	±10	μV
			E,M	±1	±5	
		Over Temperature Range (Note 1, 2)	C	±2	±20	μV
			E,M	±2	±10	
Average Temperature Coefficient of Input Offset Voltage	$\frac{\Delta V_{OS}}{\Delta T}$	Over Temperature Range (Note 1, 2)	E,M	0.02	0.05	μV/°C
Input Bias Current	I _B	T _A = +25°C	C	10	100	pA
			E,M	10	30	
		Over Temperature Range (Note 1)	C	30		pA
			E	35		
			M	0.5	5	nA
Input Offset Current	I _{OS}	T _A = +25°C	C	15	200	pA
			E,M	15	60	
		Over Temperature Range (Note 1)	C	30		pA
			E	50		
			M	0.5	10	nA
Input Resistance	R _{IN}			10 ¹²		Ω
Large Signal Voltage Gain	A _{VOL}	R _L = 10kΩ, V _{OUT} = ±10V, T _A = +25°C		120	150	dB
		Over Temperature Range (Note 1)		120	150	
Output Voltage Swing	V _{OUT}	CLAMP not connected (note 3)	R _L = 10kΩ R _L = 100kΩ	±12	±14.5 ±14.95	V
Common-Mode Voltage Range	CMVR			+11, -15	+11.5, -15.1	V
Common-Mode Rejection Ratio	CMRR	CMVR = +11V to -15V, T _A = +25°C		120	140	dB
		Over Temperature Range (Note 1)		110	140	
Power Supply Rejection Ratio	PSRR	±3V to ±16.5V, T _A = 25°C		120	140	dB
		Over Temperature Range (Note 1)		110	140	
Input Noise Voltage (P-P value not exceeded 95% of time)	e _{Np-p}	R _S = 100Ω, DC to 1Hz DC to 10 Hz		0.3		μV _{p-p}
				1.1		
Input Noise Current	I _N	f = 10Hz		0.01		pA/√Hz
Unity-Gain Bandwidth	GBW			500		kHz
Slew Rate	SR	C _L = 50pF, R _L = 10kΩ		0.5		V/μs
Rise Time	t _r			0.7		μs
Overshoot				20		%

Note 1: Operating temperature range for "C" parts is 0°C to +70°C, for "E" parts is -40°C to +85°C, and for "M" parts is -55°C to +125°C.

Note 2: Guaranteed by design.

Note 3: The OUTPUT CLAMP, pin 9 on MAX421, when connected to the inverting input (pin 4), reduces the overload recovery time inherent with chopper-stabilized amplifiers (see text).

Note 4: All pins are designed to withstand electrostatic discharge (ESD) levels in excess of 2000V (Mil Std 883C, Method 3015.2 Test Circuit).

±15 Volt Chopper Stabilized Operational Amplifier

MAX420/421/422/423

ELECTRICAL CHARACTERISTICS MAX420, MAX421 (continued)

($V^+ = +15V$, $V^- = -15V$, $T_A = +25^\circ C$. Test circuit unless noted.)

PARAMETER	SYMBOL	CONDITIONS	MIN.	TYP.	MAX.	UNITS
Operating Supply Range	V^+ , V^-		±2.5		±16.5	V
Supply Current	I_S	No Load, $T_A = +25^\circ C$ Over Temperature Range (Note 1)		1.3	2.0 3.5	mA
Internal Chopping Frequency	f_{ch}	Pins 12-14 Open (MAX421)		400		Hz
Clamp ON Current (Note 3)	$I_{CLP(ON)}$	$R_L = 100k\Omega$	25	100		μA
Clamp OFF Current (Note 3)	$I_{CLP(OFF)}$	$-10V \leq V_{OUT} \leq +10V$		1		pA
Offset Voltage vs. Time				100		nV/ $\sqrt{\text{month}}$

Note 1: Operating temperature range for "C" parts is $0^\circ C$ to $+70^\circ C$, for "E" parts is $-40^\circ C$ to $+85^\circ C$, and for "M" parts is $-55^\circ C$ to $+125^\circ C$.

Note 2: Guaranteed by design.

Note 3: The OUTPUT CLAMP, pin 9 on MAX421, when connected to the inverting input (pin 4), reduces the overload recovery time inherent with chopper-stabilized amplifiers (see text).

Note 4: All pins are designed to withstand electrostatic discharge (ESD) levels in excess of 2000V (Mil Std 883C, Method 3015.2 Test Circuit).

Typical Operating Characteristics

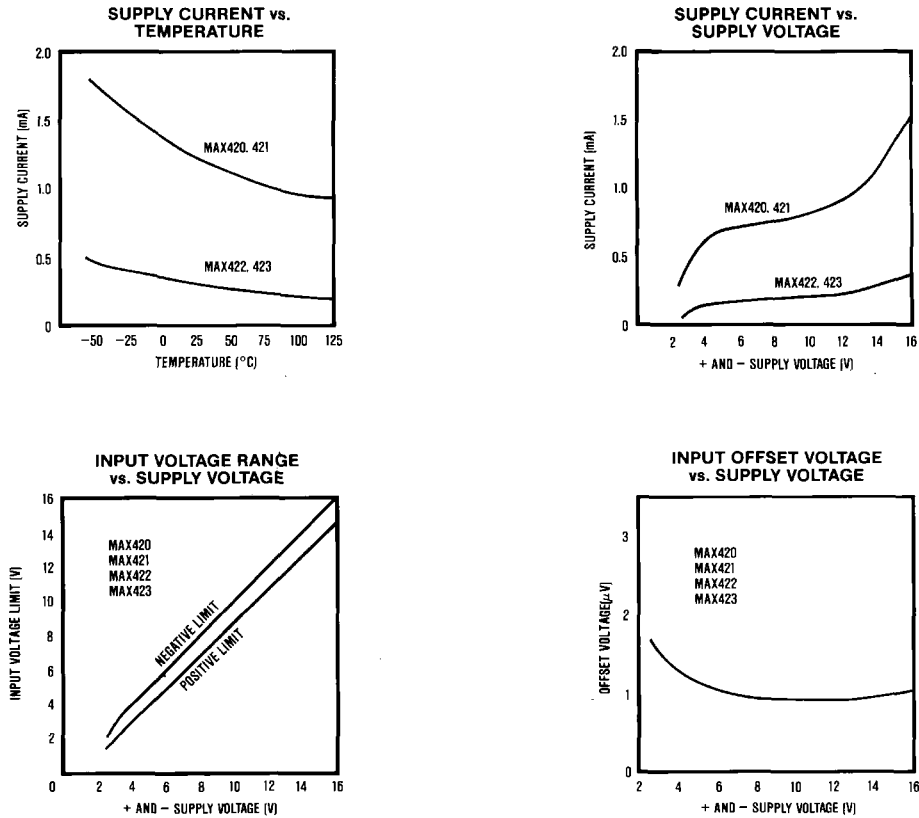

±15 Volt Chopper Stabilized Operational Amplifier

ABSOLUTE MAXIMUM RATINGS: same as for MAX420, 421

ELECTRICAL CHARACTERISTICS MAX422, MAX423

(V⁺ = +15V, V⁻ = -15V, T_A = +25°C. Test circuit unless noted.)

PARAMETER	SYMBOL	CONDITIONS	MIN.	TYP.	MAX.	UNITS
Input Offset Voltage	V _{OS}	T _A = +25°C		±1	±10	μV
		Over Temperature Range (Note 1, 2)		±1	±5	
Average Temperature Coefficient of Input Offset Voltage	$\frac{\Delta V_{OS}}{\Delta T}$	Over Temperature Range (Note 1, 2)		±2	±20	μV/°C
				±2	±10	
Input Bias Current (Doubles every 10°C above about 60°C)	I _B	T _A = +25°C		10	100	pA
		Over Temperature Range (Note 1)		10	30	
				30		pA
				35		pA
				0.5	5	nA
Input Offset Current (Doubles every 10°C above about 60°C)	I _{OS}	T _A = +25°C		15	200	pA
		Over Temperature Range (Note 1)		15	60	
				30		pA
				50		pA
				0.5	10	nA
Input Resistance	R _{IN}			10 ¹²		Ω
Large Signal Voltage Gain	A _{VOL}	R _L = 100kΩ, V _{OUT} = ±10V, T _A = +25°C Over Temperature Range (Note 1)	120	150		dB
			120	150		
Output Voltage Swing	V _{OUT}	CLAMP not connected (Note 3) R _L = 100kΩ	±14	±14.6		V
Common-Mode Voltage Range	CMVR		+11, -15	+11.5, -15.1		V
Common-Mode Rejection Ratio	CMRR	CMVR = +11V to -15V, T _A = +25°C Over Temperature Range (Note 1)	120	140		dB
			110	140		
Power Supply Rejection Ratio	PSRR	±3V to ±16.5V, T _A = +25°C Over Temperature Range (Note 1)	120	140		dB
			110	140		
Input Noise Voltage (P-P value not exceeded 95% of time)	e _{Np-p}	R _S = 100Ω, DC to 1Hz DC to 10Hz		0.4		μV _{p-p}
				1.2		
Input Noise Current	I _N	f = 10Hz		0.01		pA/√Hz
Unity-Gain Bandwidth	GBW			125		kHz
Slew Rate	SR	C _L = 50pF, R _L = 100kΩ		1.25		V/μs
Rise Time	t _r			2.8		μs
Overshoot				20		%
Operating Supply Range	V ⁺ , V ⁻		±2.5		±16.5	V
Supply Current	I _S	No Load, T _A = +25°C Over Temperature Range (Note 1)		0.3	0.5	mA
					1	
Internal Chopping Frequency	f _{ch}	Pins 12-14 Open (MAX423)		250		Hz
Clamp ON Current (Note 3)	I _{CLP (ON)}	R _L = 1MΩ	5	25		μA
Clamp OFF Current (Note 3)	I _{CLP (OFF)}	-10V ≤ V _{OUT} ≤ +10V		1		pA
Offset Voltage vs. Time				100		nV/√month

Note 1: Operating temperature range for "C" parts is 0°C to +70°C, for "E" parts is -40°C to +85°C, and for "M" parts is -55°C to +125°C.

Note 2: Guaranteed by design.

Note 3: The OUTPUT CLAMP, pin 9 on MAX423, when connected to the inverting input (pin 4), reduces the overload recovery time inherent with chopper-stabilized amplifiers (see text).

Note 4: All pins are designed to withstand electrostatic discharge (ESD) levels in excess of 2000V (Mil Std 883C, Method 3015.2 Test Circuit).

±15 Volt Chopper Stabilized Operational Amplifier

Typical Operating Characteristics

MAX420/421/422/423

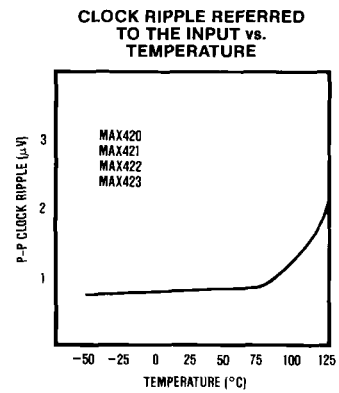
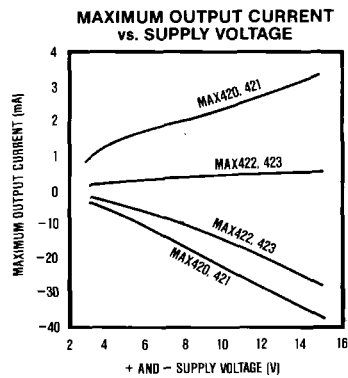
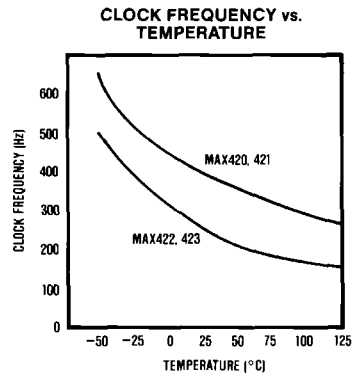
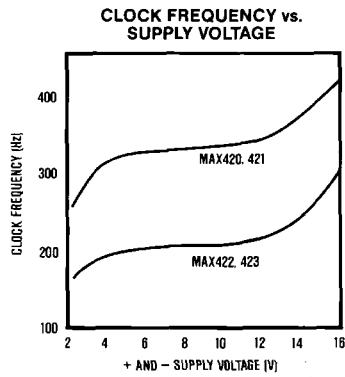
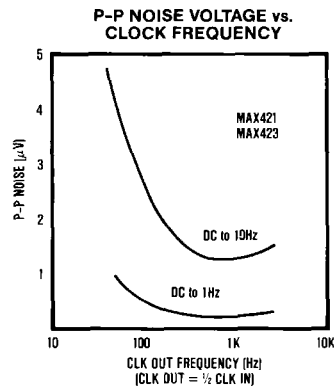
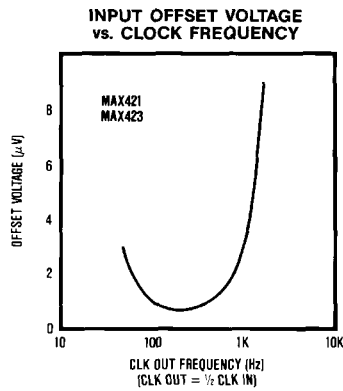

±15 Volt Chopper Stabilized Operational Amplifier

Typical Operating Characteristics

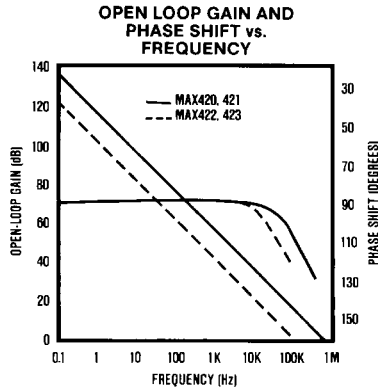
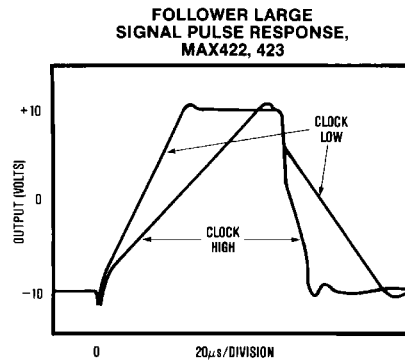
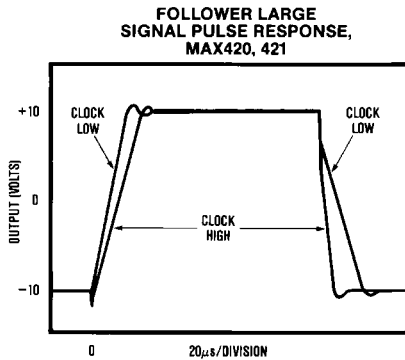

Detailed Description

Amplifier Operation

A block diagram of a MAX420 series amplifier is shown in Figure 2. Internally there are two amplifiers, a main amp and a nulling amp. The main amplifier is in the primary signal path and is continuously connected to the external inputs. The null amp alternately corrects its own offset, and then that of the main amp, as its input switches between the two main amp inputs. Offset correction is accomplished by means of compensating FETs in the input stage's bias circuitry (not shown). The offset values that drive these trim FETs are stored for the duration of the correction cycle on two capacitors, C_{EXTA} and C_{EXTB} . Each cycle is controlled by the clock as shown in the timing diagram of Figure 2. An added benefit of the offset correction scheme is that it also increases CMRR, PSRR, and A_{VOL} at low frequencies ($f_{IN} \ll f_{CLK}$).

Capacitor Selection

Two external capacitors, C_{EXTA} and C_{EXTB} , connected as shown in Figure 1, enable the amplifier to store and correct its own offset errors. The MAX420 series is specified with $0.1\mu F$ capacitors, however, other values up to $1.0\mu F$ may be optimal if different clock rates are used (MAX421, 423 only). If an external clock is used, the capacitor values should be scaled to roughly maintain the ratio between the nominal self-clock period ($2.5ms @ 400Hz$) and $0.1\mu F$. For example, if a $200Hz$ clock were used, then $0.2\mu F$ would be best. This relationship is not critical and certainly no change in capacitor value is necessary for part-to-part variations in the internal clock rate.

±15 Volt Chopper Stabilized Operational Amplifier

MAX420/421/422/423

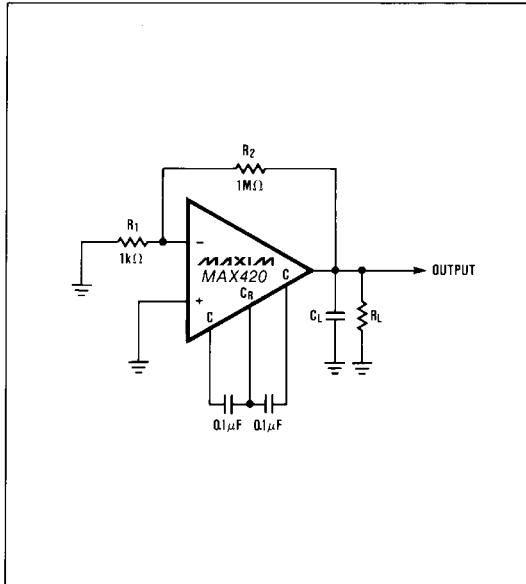

Figure 1. Test Circuit.

The banded or outer foil end of the correction capacitors should be connected to C_{RETN} as this is a low impedance point. C_{EXTA} and C_{EXTB} are high impedance nodes and so the connections to these pins should be as short as possible to minimize noise pick-up.

Capacitor Types

Precision DC performance can be realized with a wide variety of capacitor types, however those with high leakage will cause excessive clock ripple in the signal path and should not be used. Other low cost capacitors, such as ceramics, may have adequate leakage specifications but often also exhibit high dielectric absorption. This will not harm the amplifier's DC performance but can increase the initial settling time on turn-on to 1 or 2 seconds (to $1\mu V$). If fast settling after power-up is required then higher quality capacitors, such as mylar or polypropylene, should be used.

Clock

An on-chip clock is included on all 420 series amplifiers to control the operation of the offset correction circuitry. This oscillator is completely self contained and needs no external components or connections. The internal clock rate is nominally 400Hz on the MAX420/421 and is 250Hz on the MAX422/423.

External Clock

The MAX421 and 423 have an $\overline{INT/EXT}$ pin for clock selection (pin 14). The pin has an internal pull-up and, for self-clocked operation, can be left open or connected

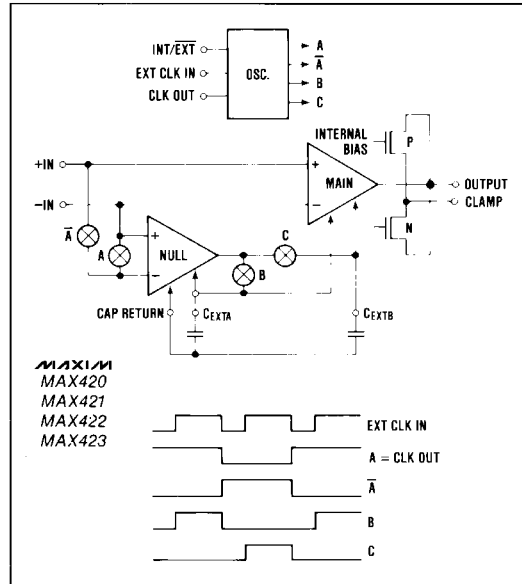

Figure 2. Maxim MAX420 Series Amplifier Block Diagram.

to V^+ . When $\overline{INT/EXT}$ is tied to V^- the internal clock is disabled and an external clock can then be applied to $EXT CLK IN$. Because of an internal divider, the offset nulling circuitry runs at one half the external clock rate.

Duty Cycle and Thresholds

The duty cycle of the external clock is not critical at low frequencies. For $EXT CLK IN$ frequencies of 500Hz or greater, a 50% to 80% positive duty cycle is recommended to allow transients on the null capacitors to settle. This is necessary because the capacitors are only charged when $EXT CLK IN$ is high. The input threshold for $EXT CLK IN$ is typically $V^+ - 2.5V$ so that an external clock signal can swing from either V^+ to GROUND or V^+ to V^- . The internal chopping frequency is available at the $CLK OUT$ pin with either internal or external clock operation. The nominal output levels for $CLK OUT$ are V^+ for a "High" and $V^+ - 5V$ for a clock "Low".

In some instances, it may be advantageous to synchronize two amplifier clocks, or slave one to another. A simple way to accomplish this is to tie the amplifiers' $EXT CLK IN$ pins together (MAX421 or 423 only) and pull one's $\overline{INT/EXT}$ pin low while allowing the other's to float high. The amplifier with $\overline{INT/EXT}$ high will then provide the clock for both devices (see Figure 9).

±15 Volt Chopper Stabilized Operational Amplifier

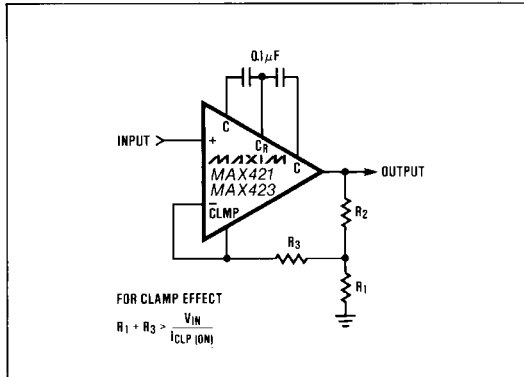

Figure 3. Non-Inverting Amplifier with Optional Clamp.

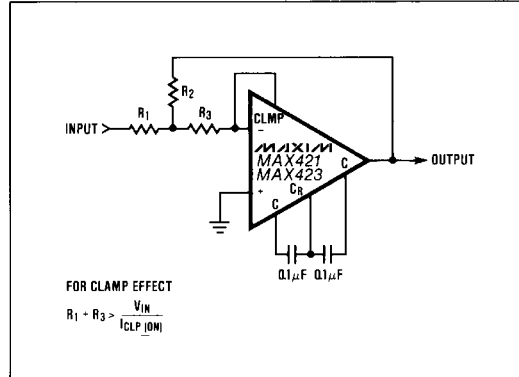

Figure 4. Inverting Amplifier with Optional Clamp.

Plugging into a Conventional Op-Amp Socket

As a result of their ±15V supply capability, the 8-pin MAX420 and 422 can plug directly into a conventional op-amp socket for immediate upgrading of DC specifications. Since the external nulling capacitors occupy what are usually "Offset null" pins (1, 5, and 8), the standard op-amp pin-out is still maintained for input, output, and supply connections. Essentially, C_{EXTA} and C_{EXTB} replace the offset trim pot normally required with conventional op-amps.

Output Clamp/Overload

The OUTPUT CLAMP, when connected to the inverting input, reduces the amplifier's overload recovery time (see Figures 3 and 4). It does this by providing a feedback path that is activated just before the output saturates. The resultant reduction in gain prevents differential input overload and consequent charge build-up on the correction capacitors. If the capacitors are allowed to overcharge, the amplifier will need time to recover (typically 500ms) after the overload is removed. Since the OUTPUT CLAMP activates slightly prior to output saturation there is also a small reduction in output swing when it is used. This reduction is typically 500mV with a 10kΩ output load.

Single Supply Operation

The 420 series amplifiers are well suited for operation in single power supply applications that have system ground connected to V⁻. With supply voltages of 10 volts or above the input range is typically from Ground to V⁺ - 1.5V. At lower supply voltages the input-range lower limit will be higher (approx. Gnd + 0.5V at 5V supply). The amplifiers' outputs will swing to within approximately 50mV of Ground or V⁺ with a 100kΩ load and within 500mV with 10kΩ (MAX420, 421 only).

Applications

Low Voltage Signals

Realizing microvolt offset and nanovolt drift performance goes beyond the selection of a precision amplifier (though it's not a bad start). When trying to amplify very low level signals any number of outside error sources can confuse the measurement. These errors are often indistinguishable from real signal or amplifier error, which of course is why they are a problem.

Thermo-Electric Effect

This property describes how thermocouples measure temperature. In short it states that two dissimilar metals in contact can be expected to generate a voltage. This is fine for thermocouples but is not so useful when pin-to-socket, socket-to-circuit board, and circuit board-to-edge connector junctions all generate signals which can add to input error. The voltage generated in such situations can range from 0.1 to 10's of μV/°C, many times the offset drift of an MAX420. In general such problems are dealt with by minimizing sockets and connectors in low level circuitry and by using components designed for low thermal EMF when connectors, relays, etc. are unavoidable.

Gradients

The presence of heat in low level circuitry is often not so much a problem as are thermal gradients. Gradients can, for example, cause normally balanced amplifier input connections to be at different temperatures. These connections then generate different thermoelectric voltages that can no longer be completely cancelled by the balanced inputs. The moral then is to minimize thermal gradients by keeping power dissipation and air currents in and around low level circuitry and connections at a minimum.

±15 Volt Chopper Stabilized Operational Amplifier

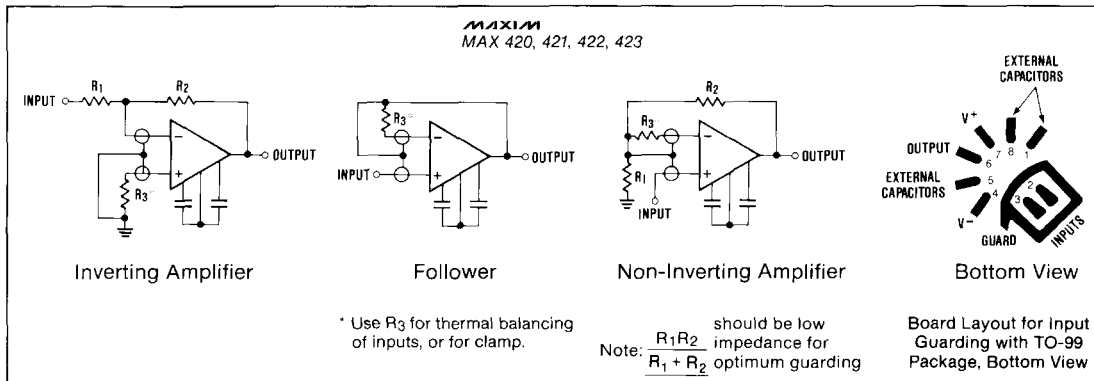

Figure 5. Input Guard Connections.

Thermal Symmetry

Another useful low level technique is to design thermal "symmetry" into the layout. This may mean adding dummy resistors and connections so that the thermal mass, as well as the number of thermoelectric error sources, in an input pair will cancel. It may also involve running input traces near each other and keeping their size the same as well. Thermal "filtering" with small enclosures or even insulation for sensitive areas can also be helpful.

Low Current Signals, Input Guards

Low leakage, high impedance CMOS inputs allow the MAX420 amplifier family to amplify the signals of very high impedance sources. Though the amplifiers' input bias current is measured in picoamps, getting the surrounding connections to live up to that specification requires some attention. In applications where picoamp or nanoamp errors can be significant, board leakage either from surface contamination or through the board material itself may be a problem.

Controlling Leakage

Using low leakage board materials and proper cleaning methods after assembly can provide marked reductions in leakage induced errors. Beyond this, conformal coatings can be used to control later surface contamination. In some cases, Teflon insulators and/or circuit board guard rings may be necessary to protect very high impedance nodes. Guard connections for various amplifier configurations are shown in Figure 5. In each case the guard is connected to a low impedance point that is approximately at the same potential as the inputs. Leakage currents from other points on the board are then absorbed by the guard. For best results, guard rings should be used on both sides of the circuit board. The 14 pin MAX421 and 423 have specifically been designed to ease input guard layout in that the pins adjacent to the inputs are unused in those packages.

Output Characteristics / Open Loop Gain

The MAX420 and 421 can typically drive a 10kΩ load from +14.8V to -14.5V when operating with ±15V power supplies. With a 100kΩ or greater load, however, the output can typically swing to within 50mV of each rail. The output swing with the lower power MAX422 and 423 will be somewhat less for a given load.

The open loop gain of a MAX420 series amplifier is somewhat load dependent for resistances which are less than 10kΩ. The effect is largely due to the impedance of the amplifier's output stage. The gain is about 17dB lower with a 1kΩ load than it is with 10kΩ. Since even with 1kΩ the gain is still typically 120dB, the reduction is insignificant for low frequency applications. In wideband circuits, however, the best results are achieved with loads of 10kΩ or more where the amplifier's open loop response is a smooth 6dB/octave slope from 0.1Hz to 0.5MHz. Additionally, there is negligible phase shift at the frequency where the null amp is rolled off.

Intermodulation

In some chopper-stabilized amplifier designs, interaction between the input signal and the chopper frequency sometimes produces intermodulation products in the form of sum and difference signals. If the input frequency and the chop rate are near enough to each other, a difference signal may even appear as a DC error at the output. The MAX420 series minimizes these problems with active compensation circuitry that virtually eliminates intermodulation effects and controls the amplifier's open loop gain-phase characteristics as well. With well behaved open loop parameters, the chopper circuitry's impact on the amplifier's dynamic performance can be ignored in most applications.

MAX420/421/422/423

±15 Volt Chopper Stabilized Operational Amplifier

Typical Applications

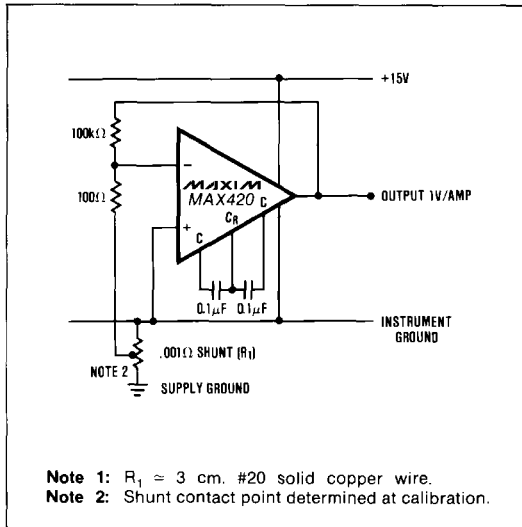

Figure 6. Ultra-low Current Shunt Amp.

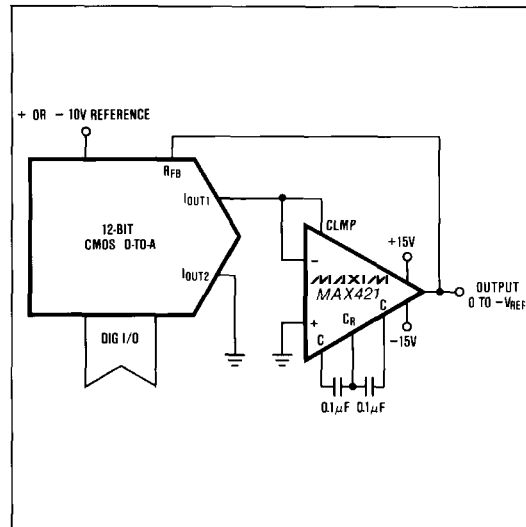

Figure 7. CMOS DAC Output Amplifier. Low offset maintains DAC linearity.

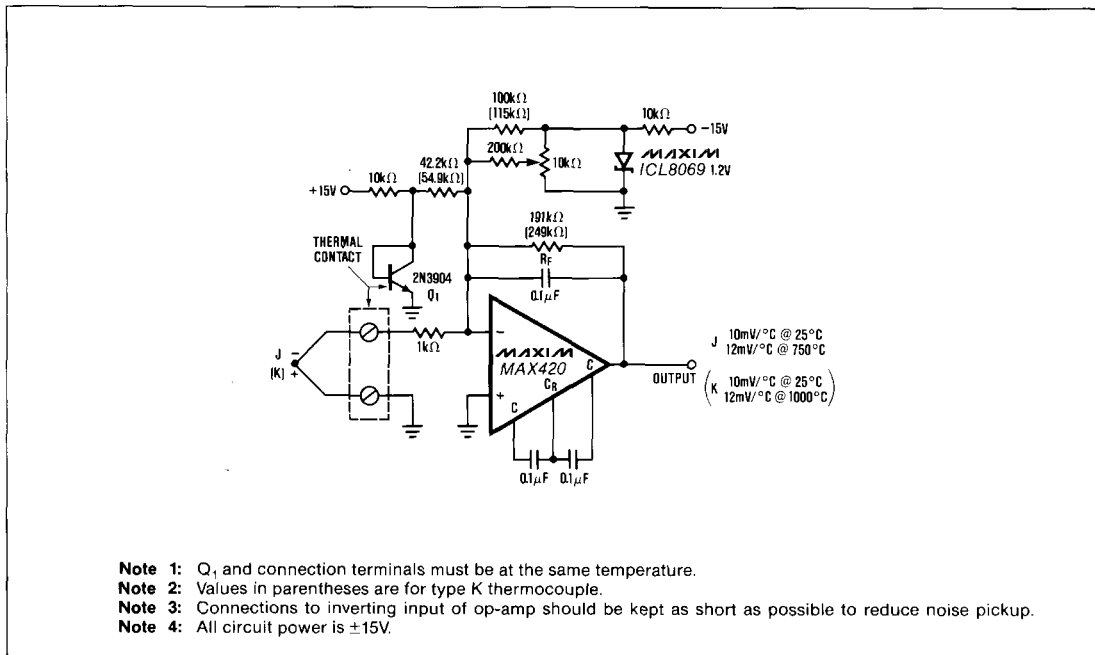

Figure 8. Amplifier with Cold-Junction Compensation for Grounded Thermocouples.

±15 Volt Chopper Stabilized Operational Amplifier

Typical Applications

MAX420/421/422/423

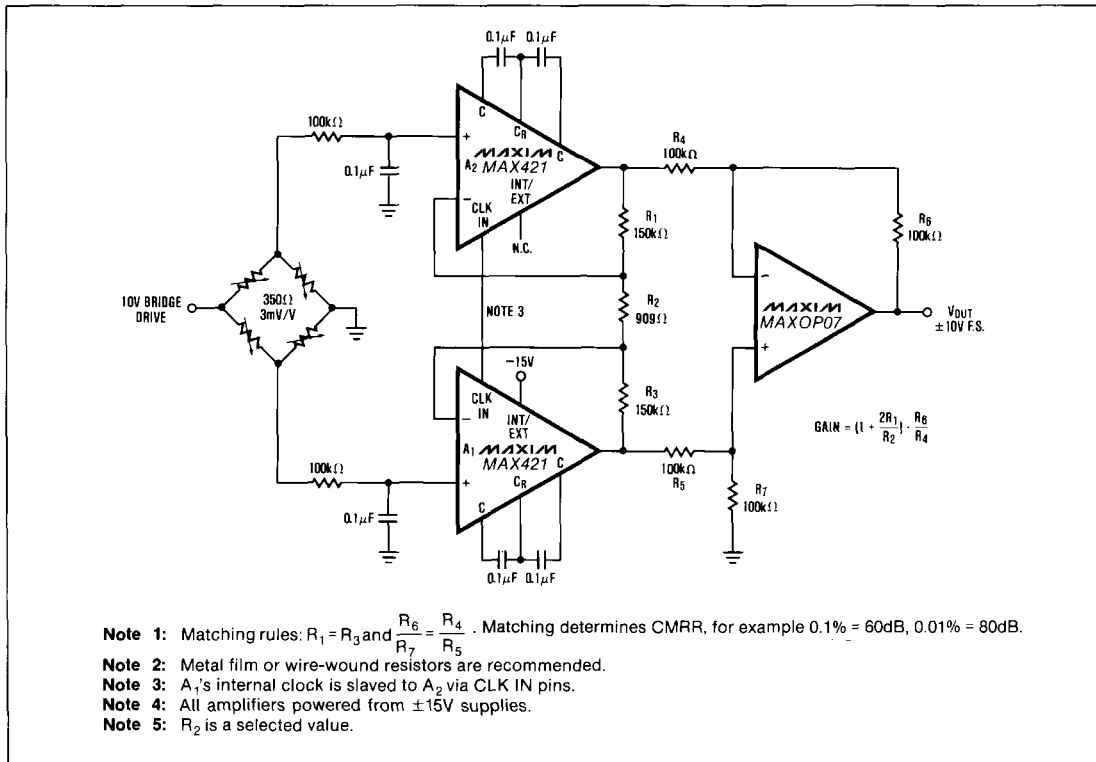

Figure 9. 10µV V_{OS}, 0.1µV/°C Strain Gauge Instrumentation Amplifier.

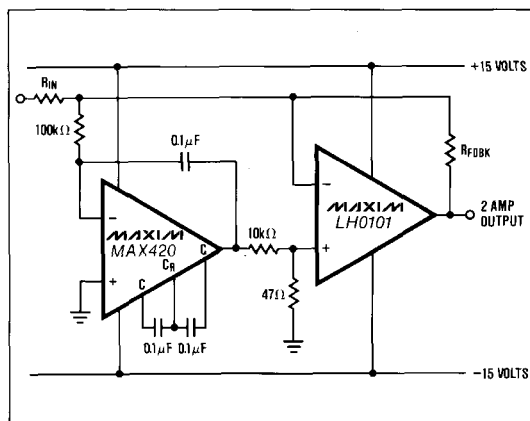
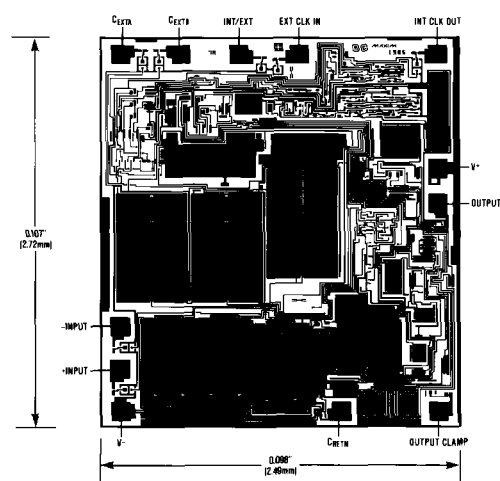

Figure 10. D.C. Stabilized Power Op-Amp. Main amp has 5MHz unity-gain point.

Chip Topography



±15 Volt Chopper Stabilized Operational Amplifier

Ordering Information (continued)

PART	TEMP. RANGE	PACKAGE
MAX421M/D	-55°C to +125°C	Dice
MAX422CPA	0°C to +70°C	8 Lead Plastic DIP
MAX422EPA	-40°C to +85°C	8 Lead Plastic DIP
MAX422MTV	-55°C to +125°C	TO-99 Metal Can
MAX423CPD	0°C to +70°C	14 Lead Plastic DIP
MAX423CWE	0°C to +70°C	16 Lead Small Outline
MAX423C/D	0°C to +70°C	Dice
MAX423EPD	-40°C to +85°C	14 Lead Plastic DIP
MAX423MJD	-55°C to +125°C	14 Lead CERDIP
MAX423M/D	-55°C to +125°C	Dice

Pin Configurations (continued)

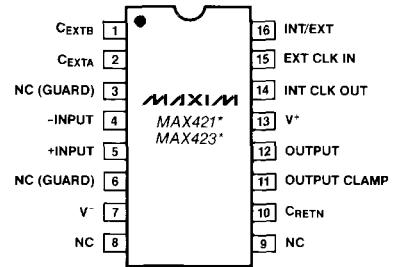

NC = No internal connection

* Pinout for small outline package only

Maxim cannot assume responsibility for use of any circuitry other than circuitry entirely embodied in a Maxim product. No circuit patent licenses are implied. Maxim reserves the right to change the circuitry and specifications without notice at any time.

Package Information

This section contains physical dimensions for all packages currently supplied by Maxim.

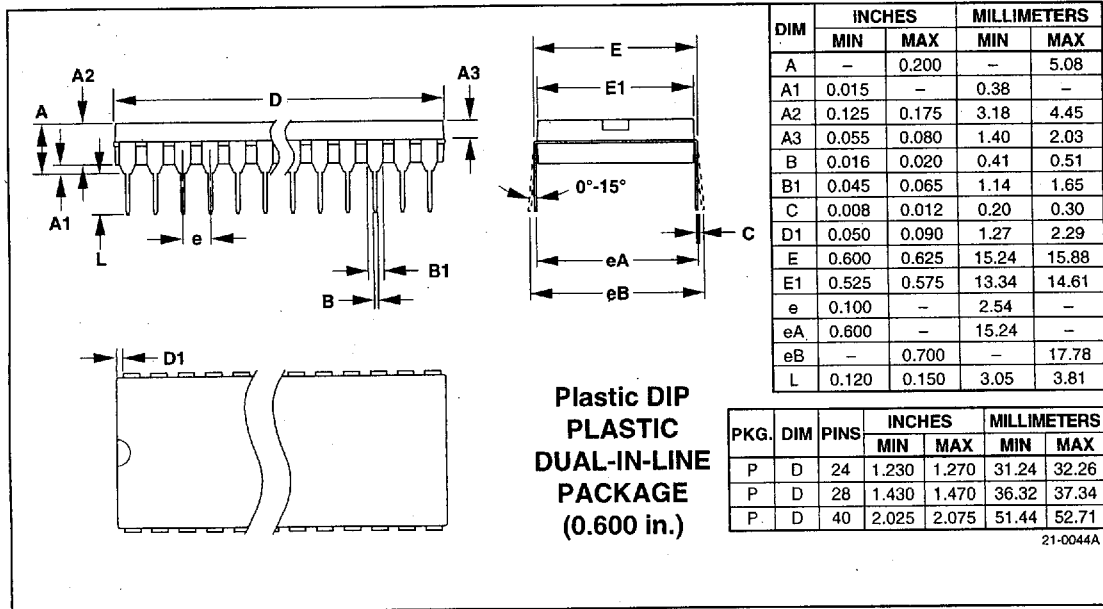
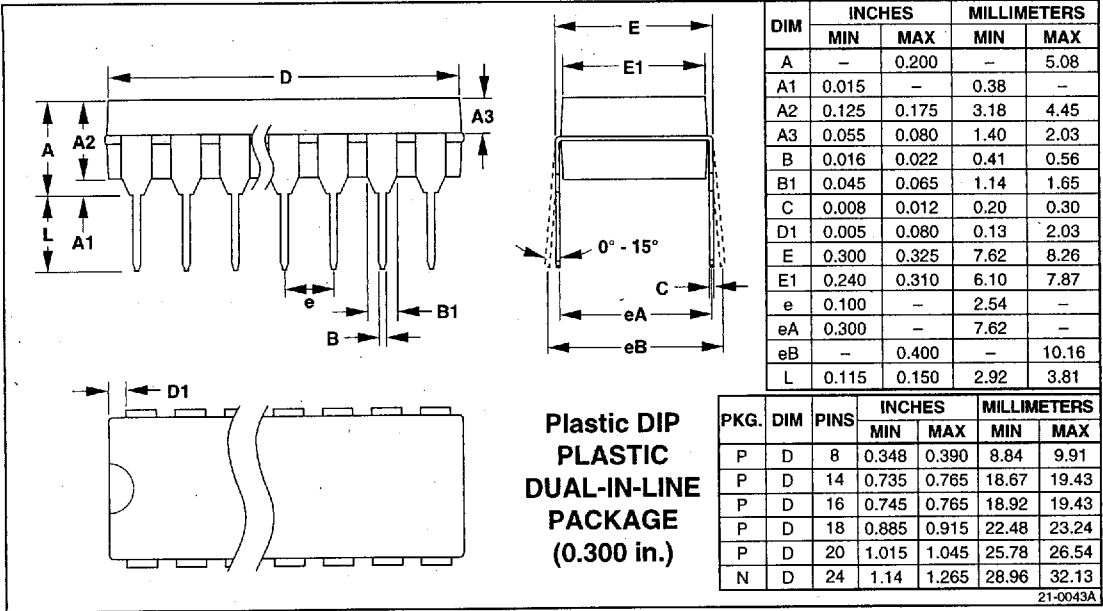

A

Package Information

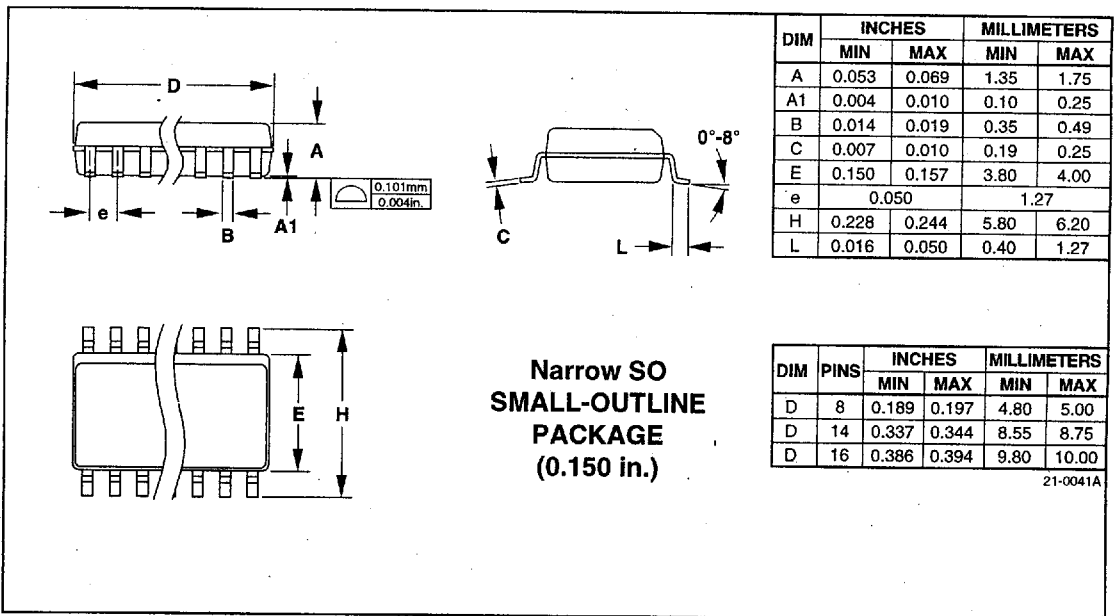
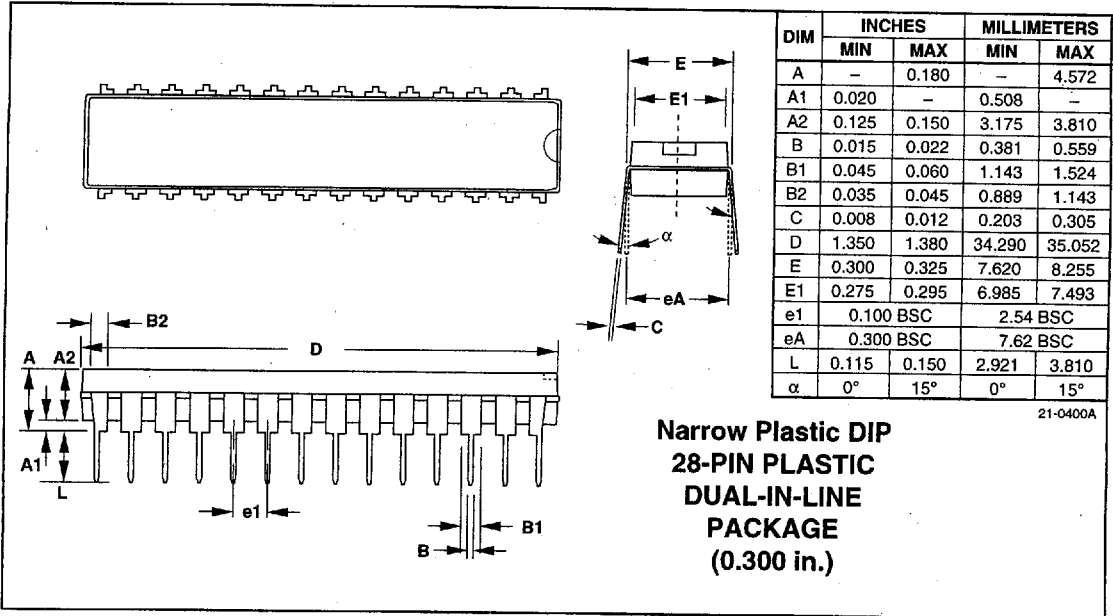

Package Information

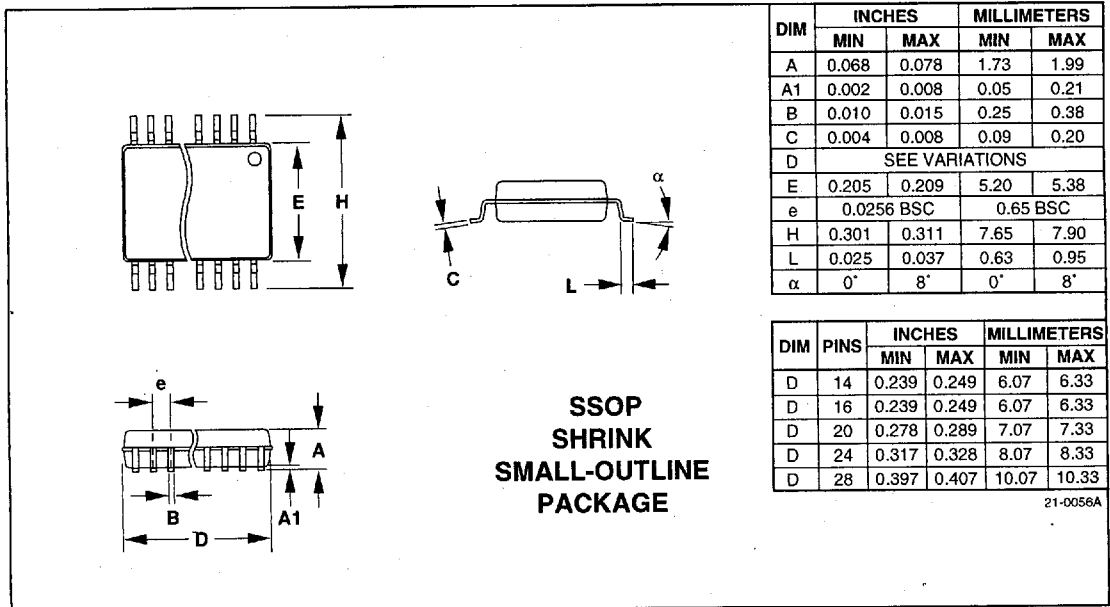
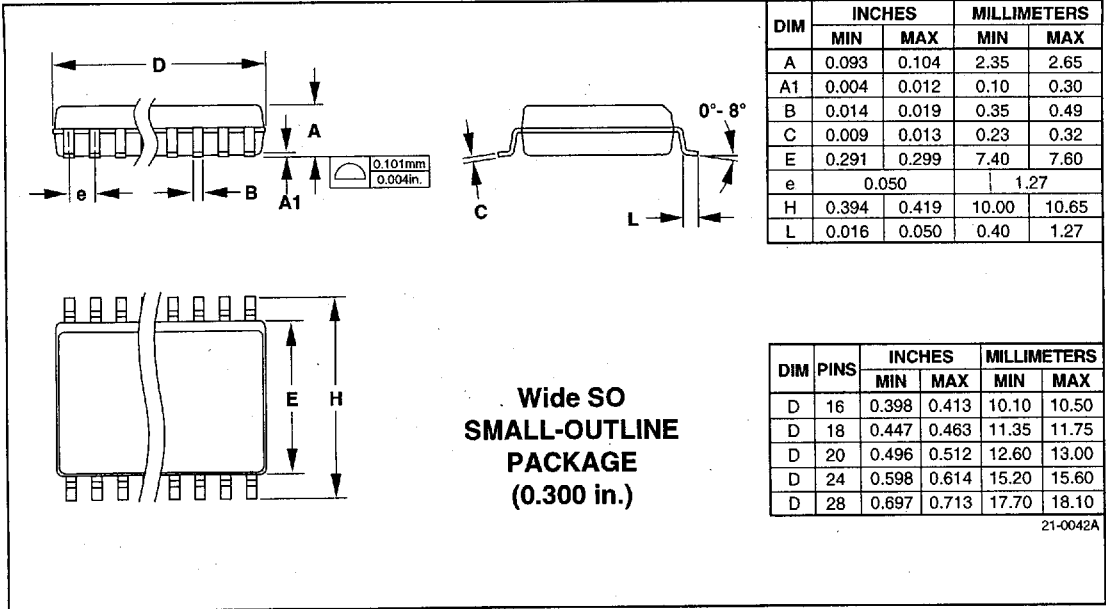

Package Information

