

# Low-Power BiCMOS Current-Mode PWM

## FEATURES

- 100 $\mu$ A Typical Starting Supply Current
- 500 $\mu$ A Typical Operating Supply Current
- Operation to 1MHz
- Internal Soft Start
- Internal Fault Soft Start
- Internal Leading-Edge Blanking of the Current Sense Signal
- 1 Amp Totem-Pole Output
- 70ns Typical Response from Current-Sense to Gate Drive Output
- 1.5% Tolerance Voltage Reference
- Same Pinout as UC3842 and UC3842A

## DESCRIPTION

The UCC1800/1/2/3/4/5 family of high-speed, low-power integrated circuits contain all of the control and drive components required for off-line and DC-to-DC fixed frequency current-mode switching power supplies with minimal parts count.

These devices have the same pin configuration as the UC1842/3/4/5 family, and also offer the added features of internal full-cycle soft start and internal leading-edge blanking of the current-sense input.

The UCC1800/1/2/3/4/5 family offers a variety of package options, temperature range options, choice of maximum duty cycle, and choice of critical voltage levels. Lower reference parts such as the UCC1803 and UCC1805 fit best into battery operated systems, while the higher reference and the higher UVLO hysteresis of the UCC1802 and UCC1804 make these ideal choices for use in off-line power supplies.

The UCC180x series is specified for operation from  $-55^{\circ}\text{C}$  to  $+125^{\circ}\text{C}$ , the UCC280x series is specified for operation from  $-40^{\circ}\text{C}$  to  $+85^{\circ}\text{C}$ , and the UCC380x series is specified for operation from  $0^{\circ}\text{C}$  to  $+70^{\circ}\text{C}$ .

Part Number	Maximum Duty Cycle	Reference Voltage	Turn-On Threshold	Turn-Off Threshold
UCCx800	100%	5V	7.2V	6.9V
UCCx801	50%	5V	9.4V	7.4V
UCCx802	100%	5V	12.5V	8.3V
UCCx803	100%	4V	4.1V	3.6V
UCCx804	50%	5V	12.5V	8.3V
UCCx805	50%	4V	4.1V	3.6V

## BLOCK DIAGRAM

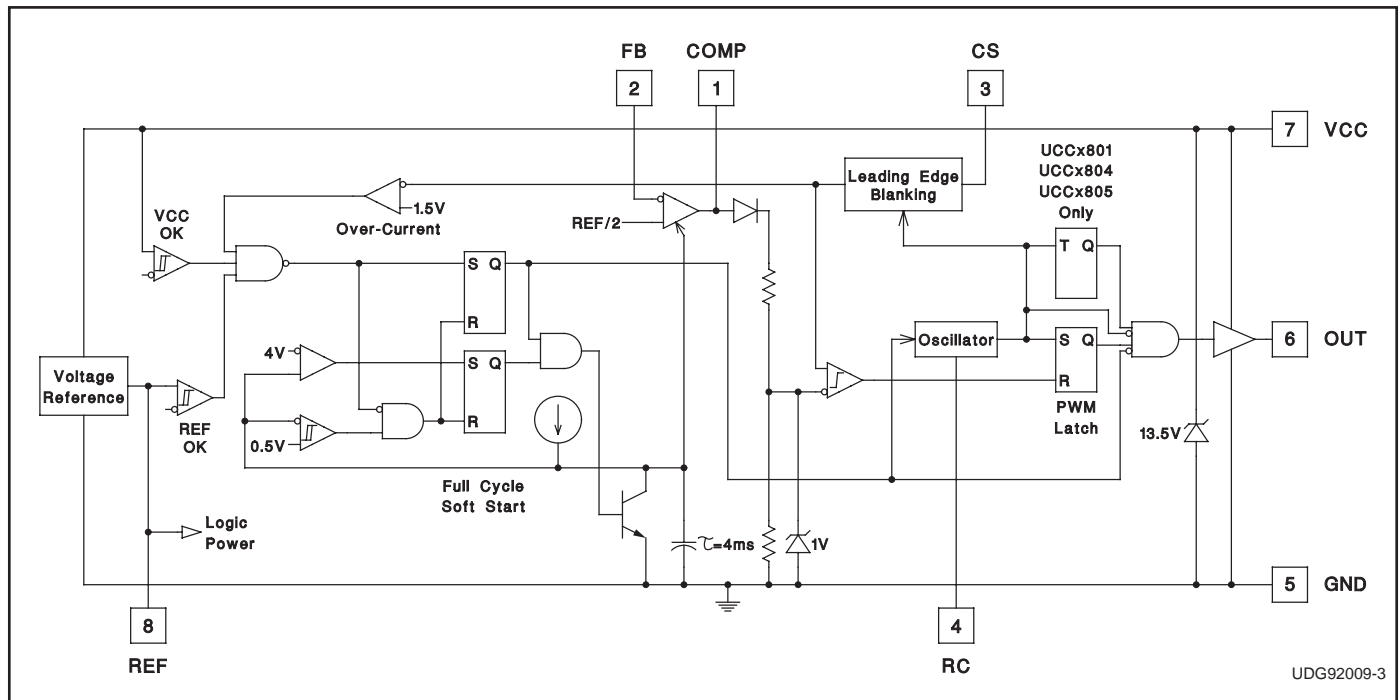

## ABSOLUTE MAXIMUM RATINGS (Note 1)

V <sub>CC</sub> Voltage (Note 2)	12.0V
V <sub>CC</sub> Current	30.0mA
OUT Current	±1.0A
OUT Energy (Capacitive Load)	20.0μJ
Analog Inputs (FB, CS)	-0.3V to 6.3V
Power Dissipation at T <sub>A</sub> < +25°C (N or J Package)	1.0W
Power Dissipation at T <sub>A</sub> < +25°C (D Package)	0.65W
Storage Temperature Range	-65°C to +150°C
Lead Temperature (Soldering, 10 Seconds)	+300°C

Note 1: All voltages are with respect to GND. All currents are positive into the specified terminal. Consult Unitrode databook for information regarding thermal specifications and limitations of packages.

Note 2: In normal operation V<sub>CC</sub> is powered through a current limiting resistor. Absolute maximum of 12V applies when V<sub>CC</sub> is driven from a low impedance source such that I<sub>CC</sub> does not exceed 30mA.

## TEMPERATURE AND PACKAGE SELECTION

	Temperature Range	Available Packages
UCC1800	-55°C to +125°C	J
UCC2800	-40°C to +85°C	N, D, PW
UCC3800	0°C to +70°C	N, D, PW

## ORDERING INFORMATION

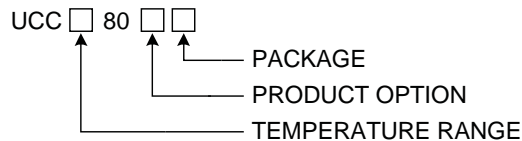

## CONNECTION DIAGRAMS

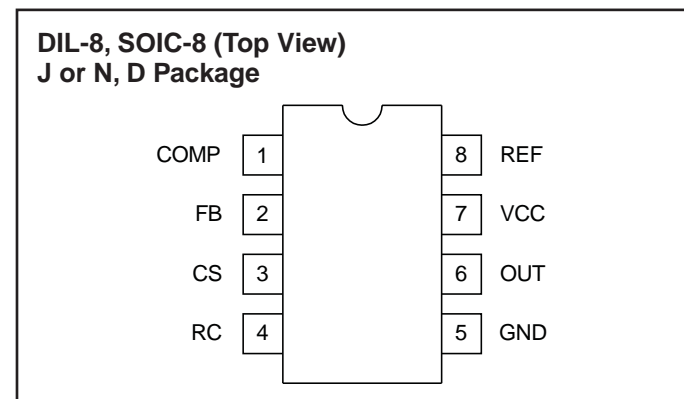
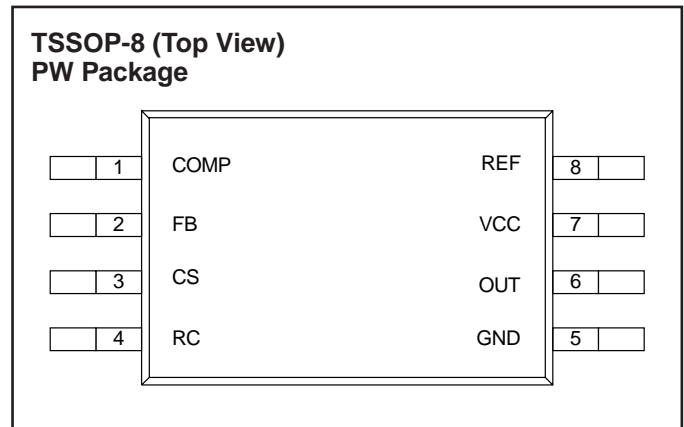

**ELECTRICAL CHARACTERISTICS** Unless otherwise stated, these specifications apply for -55°C ≤ T<sub>A</sub> ≤ +125°C for UCC180x; -40°C ≤ T<sub>A</sub> ≤ +85°C for UCC280x; 0°C ≤ T<sub>A</sub> ≤ +70°C for UCC380x; V<sub>CC</sub>=10V (Note 3); R<sub>T</sub>=100k from REF to RC; C<sub>T</sub>=330pF from RC to GND; 0.1μF capacitor from V<sub>CC</sub> to GND; 0.1μF capacitor from V<sub>REF</sub> to GND. T<sub>A</sub>=T<sub>J</sub>.

PARAMETER	TEST CONDITIONS	UCC180X UCC280X			UCC380X			UNITS
		MIN	TYP	MAX	MIN	TYP	MAX	
<b>Reference Section</b>								
Output Voltage	T <sub>J</sub> =+25°C, I=0.2mA, UCCx800/1/2/4	4.925	5.00	5.075	4.925	5.00	5.075	V
	T <sub>J</sub> =+25°C, I=0.2mA, UCCx803/5	3.94	4.00	4.06	3.94	4.00	4.06	
Load Regulation	0.2mA < I < 5mA		10	30		10	25	mV
Total Variation	UCCx800/1/2/4 (Note 7)	4.88	5.00	5.10	4.88	5.00	5.10	V
	UCCx803/5 (Note 7)	3.90	4.00	4.08	3.90	4.00	4.08	V
Output Noise Voltage	10Hz ≤ f ≤ 10kHz, T <sub>J</sub> =+25°C (Note 9)		130			130		μV
Long Term Stability	T <sub>A</sub> =+125°C, 1000 Hours (Note 9)		5			5		mV
Output Short Circuit		-5		-35	-5		-35	mA
<b>Oscillator Section</b>								
Oscillator Frequency	UCCx800/1/2/4 (Note 4)	40	46	52	40	46	52	kHz
	UCCx803/5 (Note 4)	26	31	36	26	31	36	
Temperature Stability	(Note 9)		2.5			2.5		%
Amplitude peak-to-peak		2.25	2.40	2.55	2.25	2.40	2.55	V
Oscillator Peak Voltage			2.45			2.45		V

**ELECTRICAL CHARACTERISTICS** Unless otherwise stated, these specifications apply for  $-55^{\circ}\text{C} \leq T_A \leq +125^{\circ}\text{C}$  for UCC180x;  $-40^{\circ}\text{C} \leq T_A \leq +85^{\circ}\text{C}$  for UCC280x;  $0^{\circ}\text{C} \leq T_A \leq +70^{\circ}\text{C}$  for UCC380x;  $V_{CC}=10\text{V}$  (Note 3);  $RT=100\text{k}$  from REF to RC;  $CT=330\text{pF}$  from RC to GND;  $0.1\mu\text{F}$  capacitor from  $V_{CC}$  to GND;  $0.1\mu\text{F}$  capacitor from  $V_{REF}$  to GND.  $T_A=T_J$ .

PARAMETER	TEST CONDITIONS	UCC180X UCC280X			UCC380X			UNITS
<b>Error Amplifier Section</b>								
Input Voltage	COMP=2.5V; UCCx800/1/2/4	2.44	2.50	2.56	2.44	2.50	2.56	V
	COMP=2.0V; UCCx803/5	1.95	2.0	2.05	1.95	2.0	2.05	
Input Bias Current		-1		1	-1		1	$\mu\text{A}$
Open Loop Voltage Gain		60	80		60	80		dB
COMP Sink Current	FB=2.7V, COMP=1.1V	0.3		3.5	0.4		2.5	mA
COMP Source Current	FB=1.8V, COMP=REF-1.2V	-0.2	-0.5	-0.8	-0.2	-0.5	-0.8	mA
Gain Bandwidth Product	(Note 9)		2			2		MHz
<b>PWM Section</b>								
Maximum Duty Cycle	UCCx800/2/3	97	99	100	97	99	100	%
	UCCx801/4/5	48	49	50	48	49	50	
Minimum Duty Cycle	COMP=0V			0			0	%
<b>Current Sense Section</b>								
Gain	(Note 5)	1.10	1.65	1.80	1.10	1.65	1.80	V/V
Maximum Input Signal	COMP=5V (Note 6)	0.9	1.0	1.1	0.9	1.0	1.1	V
Input Bias Current		-200		200	-200		200	nA
CS Blank Time		50	100	150	50	100	150	ns
Over-Current Threshold		1.42	1.55	1.68	1.42	1.55	1.68	V
COMP to CS Offset	CS=0V	0.45	0.90	1.35	0.45	0.90	1.35	V
<b>Output Section</b>								
OUT Low Level	I=20mA, all parts		0.1	0.4		0.1	0.4	V
	I=200mA, all parts		0.35	0.90		0.35	0.90	V
	I=50mA, VCC=5V, UCCx803/5		0.15	0.40		0.15	0.40	V
	I=20mA, VCC=0V, all parts		0.7	1.2		0.7	1.2	V
OUT High $V_{SAT}$ ( $V_{CC}-OUT$ )	I=-20mA, all parts		0.15	0.40		0.15	0.40	V
	I=-200mA, all parts		1.0	1.9		1.0	1.9	V
	I=-50mA, VCC=5V, UCCx803/5		0.4	0.9		0.4	0.9	V
Rise Time	$C_L=1\text{nF}$		41	70		41	70	ns
Fall Time	$C_L=1\text{nF}$		44	75		44	75	ns
<b>Undervoltage Lockout Section</b>								
Start Threshold (Note 8)	UCCx800	6.6	7.2	7.8	6.6	7.2	7.8	V
	UCCx801	8.6	9.4	10.2	8.6	9.4	10.2	V
	UCCx802/4	11.5	12.5	13.5	11.5	12.5	13.5	V
	UCCx803/5	3.7	4.1	4.5	3.7	4.1	4.5	V
Stop Threshold (Note 8)	UCCx1800	6.3	6.9	7.5	6.3	6.9	7.5	V
	UCCx1801	6.8	7.4	8.0	6.8	7.4	8.0	V
	UCCx802/4	7.6	8.3	9.0	7.6	8.3	9.0	V
	UCCx803/5	3.2	3.6	4.0	3.2	3.6	4.0	V
Start to Stop Hysteresis	UCCx800	0.12	0.3	0.48	0.12	0.3	0.48	V
	UCCx801	1.6	2	2.4	1.6	2	2.4	V
	UCCx802/4	3.5	4.2	5.1	3.5	4.2	5.1	V
	UCCx803/5	0.2	0.5	0.8	0.2	0.5	0.8	V

**ELECTRICAL CHARACTERISTICS** Unless otherwise stated, these specifications apply for  $-55^{\circ}\text{C} \leq T_A \leq +125^{\circ}\text{C}$  for UCC180x;  $-40^{\circ}\text{C} \leq T_A \leq +85^{\circ}\text{C}$  for UCC280x;  $0^{\circ}\text{C} \leq T_A \leq +70^{\circ}\text{C}$  for UCC380x;  $V_{\text{CC}}=10\text{V}$  (Note 3);  $\text{RT}=100\text{k}$  from REF to RC;  $\text{CT}=330\text{pF}$  from RC to GND;  $0.1\mu\text{F}$  capacitor from  $V_{\text{CC}}$  to GND;  $0.1\mu\text{F}$  capacitor from  $V_{\text{REF}}$  to GND.  $T_A=T_J$ .

PARAMETER	TEST CONDITIONS	UCC180X UCC280X		UCC380X			UNITS	
<b>Soft Start Section</b>								
COMP Rise Time	FB=1.8V, Rise from 0.5V to REF-1V		4	10		4	10	ms
<b>Overall Section</b>								
Start-up Current	$V_{\text{CC}} < \text{Start Threshold}$		0.1	0.2		0.1	0.2	mA
Operating Supply Current	FB=0V, CS=0V		0.5	1.0		0.5	1.0	mA
VCC Internal Zener Voltage	$I_{\text{CC}}=10\text{mA}$ (Note 8)	12	13.5	15	12	13.5	15	V
VCC Internal Zener Voltage Minus Start Threshold Voltage	UCCx802/4	0.5	1.0		0.5	1.0		V

Note 3: Adjust VCC above the start threshold before setting at 10V.

Note 4: Oscillator frequency for the UCCx800, UCCx802 and UCCx803 is the output frequency.

Oscillator frequency for the UCCx801, UCCx804 and UCCx805 is twice the output frequency.

Note 5: Gain is defined by:  $A = \frac{\Delta V_{\text{COMP}}}{\Delta V_{\text{CS}}}$   $0 \leq V_{\text{CS}} \leq 0.8\text{V}$ .

Note 6: Parameter measured at trip point of latch with Pin 2 at 0V.

Note 7: Total Variation includes temperature stability and load regulation.

Note 8: Start Threshold, Stop Threshold and Zener Shunt Thresholds track one another.

Note 9: Guaranteed by design. Not 100% tested in production.

## PIN DESCRIPTIONS

**COMP:** COMP is the output of the error amplifier and the input of the PWM comparator.

Unlike other devices, the error amplifier in the UCC3800 family is a true, low output-impedance, 2MHz operational amplifier. As such, the COMP terminal can both source and sink current. However, the error amplifier is internally current limited, so that you can command zero duty cycle by externally forcing COMP to GND.

The UCC3800 family features built-in full cycle Soft Start. Soft Start is implemented as a clamp on the maximum COMP voltage.

**CS:** CS is the input to the current sense comparators. The UCC3800 family has two different current sense comparators: the PWM comparator and an over-current comparator.

The UCC3800 family contains digital current sense filtering, which disconnects the CS terminal from the current sense comparator during the 100ns interval immediately following the rising edge of the OUT pin. This digital filtering, also called leading-edge blanking, means that in most applications, no analog filtering (RC filter) is required on CS. Compared to an external RC filter technique, the leading-edge blanking provides a smaller

effective CS to OUT propagation delay. Note, however, that the minimum non-zero On-Time of the OUT signal is directly affected by the leading-edge blanking and the CS to OUT propagation delay.

The over-current comparator is only intended for fault sensing, and exceeding the over-current threshold will cause a soft start cycle.

**FB:** FB is the inverting input of the error amplifier. For best stability, keep FB lead length as short as possible and FB stray capacitance as small as possible.

**GND:** GND is reference ground and power ground for all functions on this part.

**OUT:** OUT is the output of a high-current power driver capable of driving the gate of a power MOSFET with peak currents exceeding  $\pm 750\text{mA}$ . OUT is actively held low when  $V_{\text{CC}}$  is below the UVLO threshold.

The high-current power driver consists of FET output devices, which can switch all of the way to GND and all of the way to  $V_{\text{CC}}$ . The output stage also provides a very low impedance to overshoot and undershoot. This means that in many cases, external schottky clamp diodes are not required.

**PIN DESCRIPTIONS (cont.)**

**RC:** RC is the oscillator timing pin. For fixed frequency operation, set timing capacitor charging current by connecting a resistor from REF to RC. Set frequency by connecting a timing capacitor from RC to GND. For best performance, keep the timing capacitor lead to GND as short and direct as possible. If possible, use separate ground traces for the timing capacitor and all other functions.

The frequency of oscillation can be estimated with the following equations:

$$\text{UCCx800/1/2/4: } F = \frac{1.5}{R \cdot C}$$

$$\text{UCCx803, UCCx805: } F = \frac{1.0}{R \cdot C}$$

where frequency is in Hz, resistance is in ohms, and capacitance is in farads. The recommended range of timing resistors is between 10k and 200k and timing capacitor is 100pF to 1000pF. Never use a timing resistor less than 10k.

To prevent noise problems, bypass VCC to GND with a ceramic capacitor as close to the VCC pin as possible. An electrolytic capacitor may also be used in addition to the ceramic capacitor.

**REF:** REF is the voltage reference for the error amplifier and also for many other functions on the IC. REF is also

used as the logic power supply for high speed switching logic on the IC.

When  $V_{CC}$  is greater than 1V and less than the UVLO threshold, REF is pulled to ground through a 5k ohm resistor. This means that REF can be used as a logic output indicating power system status. It is important for reference stability that REF is bypassed to GND with a ceramic capacitor as close to the pin as possible. An electrolytic capacitor may also be used in addition to the ceramic capacitor. A minimum of 0.1µF ceramic is required. Additional REF bypassing is required for external loads greater than 2.5mA on the reference.

To prevent noise problems with high speed switching transients, bypass REF to ground with a ceramic capacitor very close to the IC package.

**VCC:**  $V_{CC}$  is the power input connection for this device. In normal operation  $V_{CC}$  is powered through a current limiting resistor. Although quiescent  $V_{CC}$  current is very low, total supply current will be higher, depending on OUT current. Total  $V_{CC}$  current is the sum of quiescent  $V_{CC}$  current and the average OUT current. Knowing the operating frequency and the MOSFET gate charge ( $Q_g$ ), average OUT current can be calculated from:

$$I_{OUT} = Q_g \times F.$$

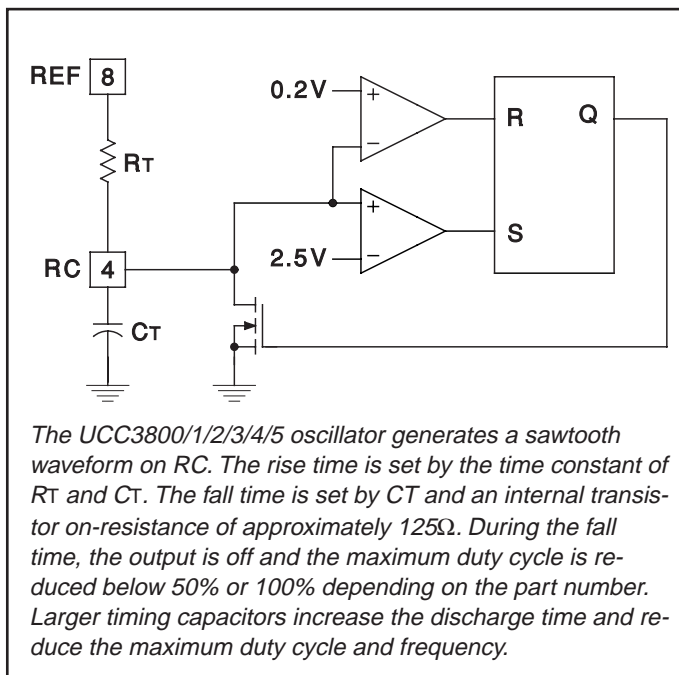

**Figure 1. Oscillator.**

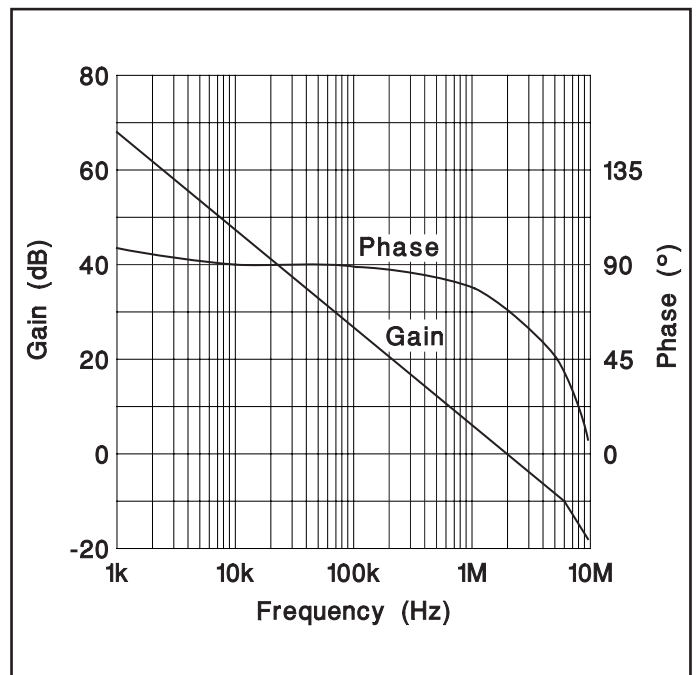

**Figure 2. Error amplifier gain/phase response.**

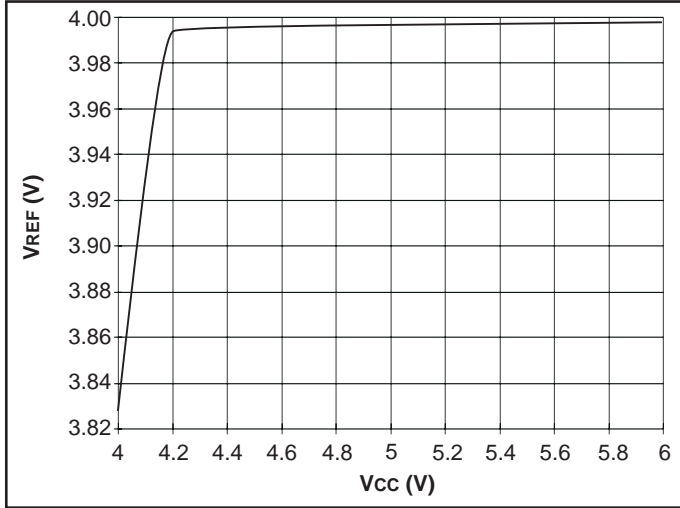

Figure 3. UCC1803/5  $V_{REF}$  vs.  $V_{CC}$ ;  $I_{LOAD} = 0.5mA$ .

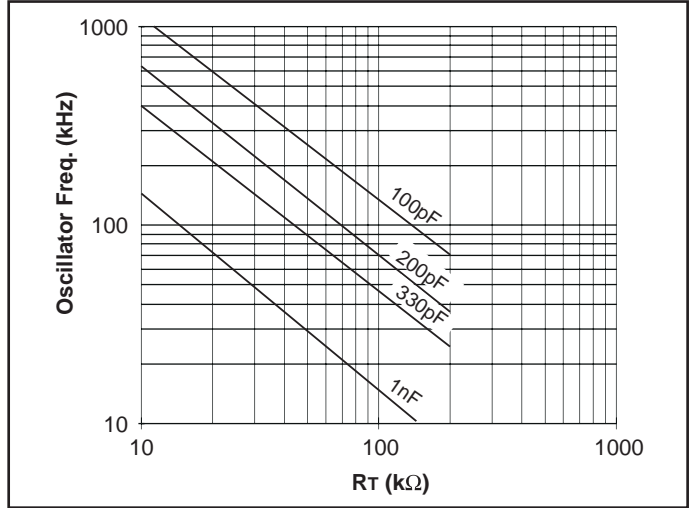

Figure 4. UCC1800/1/2/4 oscillator frequency vs.  $R_T$  and  $C_T$ .

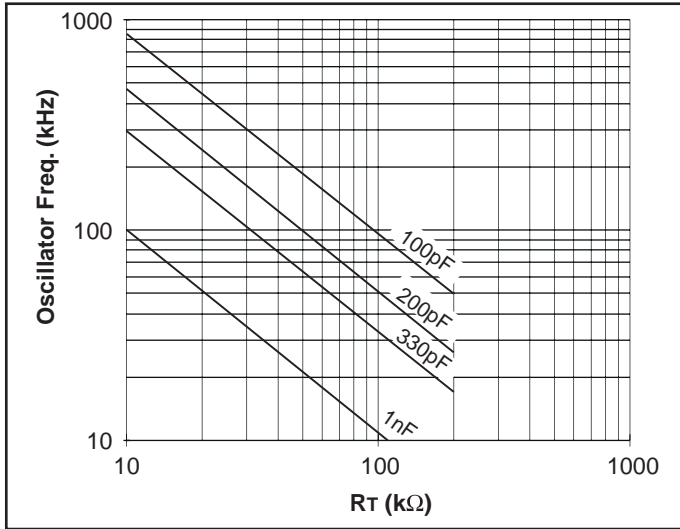

Figure 5. UCC1803/5 oscillator frequency vs.  $R_T$  and  $C_T$ .

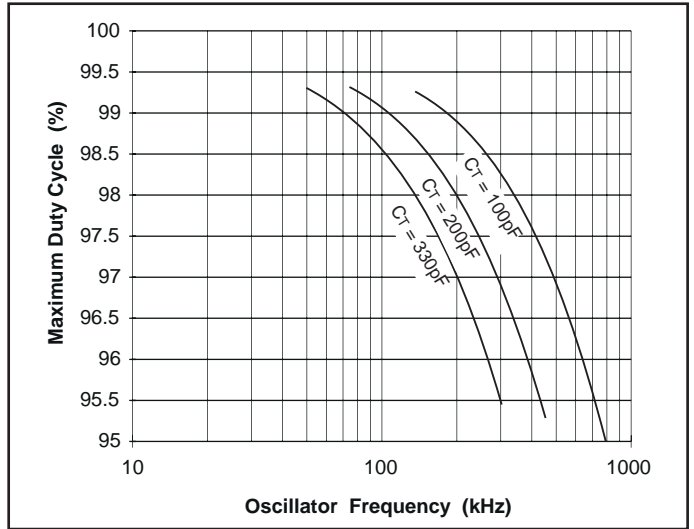

Figure 6. UCC1800/2/3 maximum duty cycle vs. oscillator frequency.

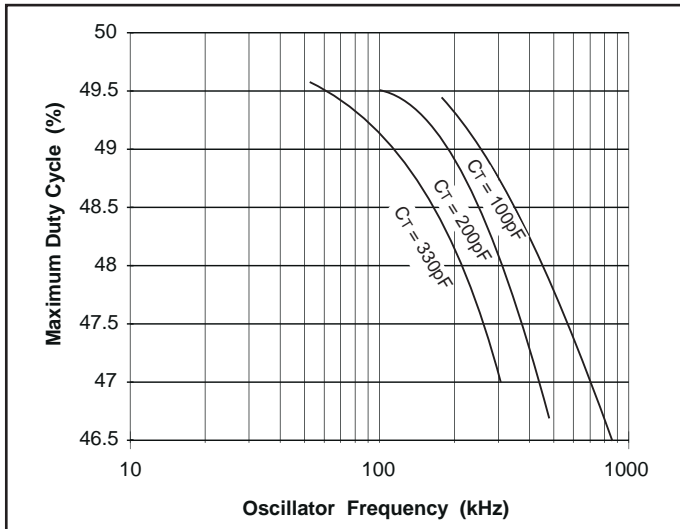

Figure 7. UCC1801/4/5 maximum duty cycle vs. oscillator frequency.

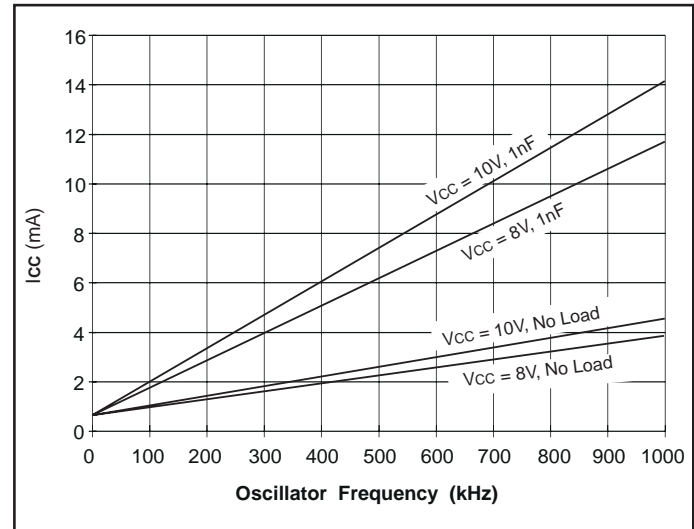

Figure 8. UCC1800  $I_{CC}$  vs. oscillator frequency.

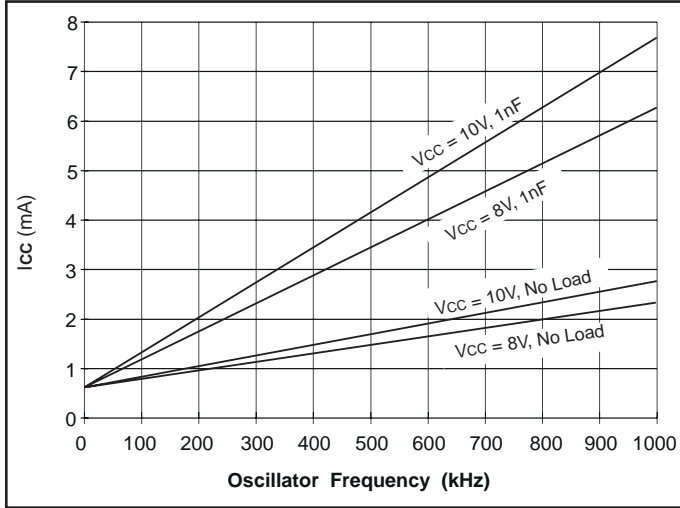

Figure 8. UCC1805 I<sub>cc</sub> vs. oscillator frequency.

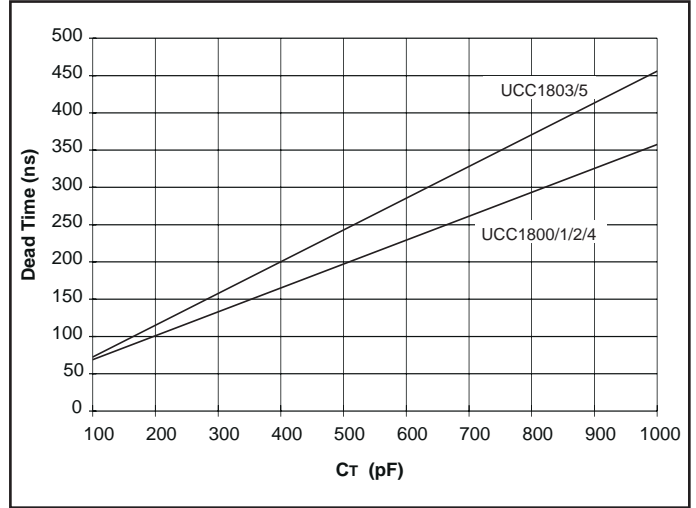

Figure 9. Dead time vs. C<sub>T</sub>, R<sub>T</sub> = 100k.

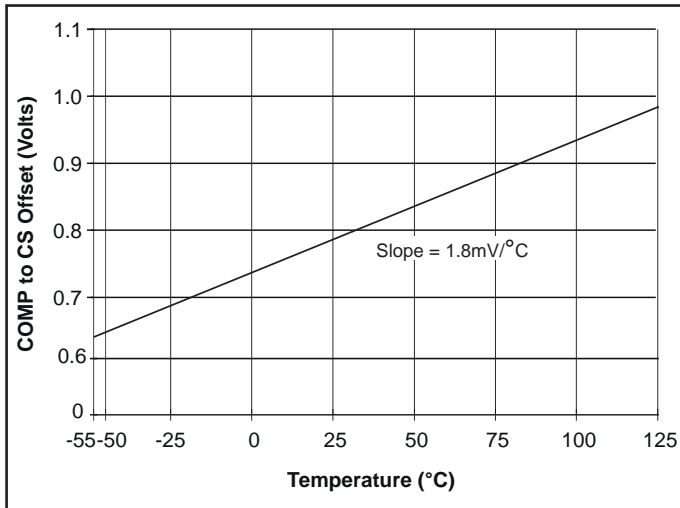

Figure 10. COMP to CS offset vs. temperature, CS = 0V.



## IMPORTANT NOTICE

Texas Instruments and its subsidiaries (TI) reserve the right to make changes to their products or to discontinue any product or service without notice, and advise customers to obtain the latest version of relevant information to verify, before placing orders, that information being relied on is current and complete. All products are sold subject to the terms and conditions of sale supplied at the time of order acknowledgement, including those pertaining to warranty, patent infringement, and limitation of liability.

TI warrants performance of its semiconductor products to the specifications applicable at the time of sale in accordance with TI's standard warranty. Testing and other quality control techniques are utilized to the extent TI deems necessary to support this warranty. Specific testing of all parameters of each device is not necessarily performed, except those mandated by government requirements.

CERTAIN APPLICATIONS USING SEMICONDUCTOR PRODUCTS MAY INVOLVE POTENTIAL RISKS OF DEATH, PERSONAL INJURY, OR SEVERE PROPERTY OR ENVIRONMENTAL DAMAGE ("CRITICAL APPLICATIONS"). TI SEMICONDUCTOR PRODUCTS ARE NOT DESIGNED, AUTHORIZED, OR WARRANTED TO BE SUITABLE FOR USE IN LIFE-SUPPORT DEVICES OR SYSTEMS OR OTHER CRITICAL APPLICATIONS. INCLUSION OF TI PRODUCTS IN SUCH APPLICATIONS IS UNDERSTOOD TO BE FULLY AT THE CUSTOMER'S RISK.

In order to minimize risks associated with the customer's applications, adequate design and operating safeguards must be provided by the customer to minimize inherent or procedural hazards.

TI assumes no liability for applications assistance or customer product design. TI does not warrant or represent that any license, either express or implied, is granted under any patent right, copyright, mask work right, or other intellectual property right of TI covering or relating to any combination, machine, or process in which such semiconductor products or services might be or are used. TI's publication of information regarding any third party's products or services does not constitute TI's approval, warranty or endorsement thereof.





**TEXAS INSTRUMENTS**

**THE WORLD LEADER IN DSP AND ANALOG**

Search Power Portal ▼

▣ Advanced Search
▣ TI Home
▣ TI&ME
▣ Employment

▣ Tech Support
▣ Comments
▣ Site Map
▣ TI Global

**Power Management**

Power Management Home ▼

> > [Power Management](#) > [PWM Power Supply Products](#) > [Current Mode](#)



## UCC3800, LOW-POWER BICMOS CURRENT-MODE PWM

Device Status: Active

- > [Description](#)
- > [Features](#)
- > [Datasheets](#)
- > [Pricing/Samples/Availability](#)
- > [Application Notes](#)
- > [Applications](#)

Parameter Name	UCC3800
Shutdown	No
Output Type	Single, Totem Pole
Output Current (mA)	+/-1000
Frequency (max) (kHz)	1000
Pulse - by - Pulse Isense	Yes
Reference Voltage (V)	5
Vref tol (%)	1.5
Startup Current (uA)	100
Duty Cycle (max) (%)	100
Operating Supply Current (mA)	0.5
Operating Supply (max) (V)	12
Operating Supply (min) (V)	6.9
PWM Outputs (#)	1
Error Amplifier GBW (mHz)	2

### Description



The UCC1800/1/2/3/4/5 family of high-speed, low-power integrated circuits contain all of the control and drive components required for off-line and DC-to-DC fixed frequency current-mode switching power supplies with minimal parts count.

These devices have the same pin configuration as the UC1842/3/4/5 family, and also offer the added features of internal full-cycle soft start and internal leading-edge blanking of the current-sense input.

The UCC1800/1/2/3/4/5 family offers a variety of package options, temperature range

The UCC1800/1/2/3/4/5 family offers a variety of package options, temperature range options, choice of maximum duty cycle, and choice of critical voltage levels. Lower reference parts such as the UCC1803 and UCC1805 fit best into battery operated systems, while the higher reference and the higher UVLO hysteresis of the UCC1802 and UCC1804 make these ideal choices for use in off-line power supplies.

The UCC180x series is specified for operation from  $-55^{\circ}\text{C}$  to  $+125^{\circ}\text{C}$ , the UCC280x series is specified for operation from  $-40^{\circ}\text{C}$  to  $+85^{\circ}\text{C}$ , and the UCC380x series is specified for operation from  $0^{\circ}\text{C}$  to  $+70^{\circ}\text{C}$ .

## Features

- 100uA Typical Starting Supply Current
- 500uA Typical Operating Supply Current
- Operation to 1MHz
- Internal Soft Start
- Internal Fault Soft Start
- Internal Leading-Edge Blanking of the Current Sense Signal
- 1 Amp Totem-Pole Output
- 70ns Typical Response from Current-Sense to Gate Drive Output
- 1.5% Tolerance Voltage Reference
- Same Pinout as UC3842 and UC3842A

To view the following documents, [Acrobat Reader 3.x](#) is required.

To download a document to your hard drive, right-click on the link and choose 'Save'.

## Datasheets

Full datasheet in Acrobat PDF: [slus270.pdf](#) (210 KB)

Full datasheet in Zipped PostScript: [slus270.psz](#) (154 KB)

## Pricing/Samples/Availability

Orderable Device	Package	Pins	Temp (°C)	Status	Price/unit USD (100-999)	Pack Qty	Availability / Samples
UCC3800D	<a href="#">D</a>	8	0 TO 70	ACTIVE	1.95	1	<a href="#">Check stock or order</a>
UCC3800DTR	<a href="#">D</a>	8	0 TO 70	ACTIVE	1.77	1	<a href="#">Check stock or order</a>
UCC3800N	<a href="#">P</a>	8	0 TO 70	ACTIVE	1.91	50	<a href="#">Check stock or order</a>
UCC3800PW	<a href="#">PW</a>	8	0 TO 70	ACTIVE	2.14	1	<a href="#">Check stock or order</a>
UCC3800PWTR	<a href="#">PW</a>	8	0 TO 70	ACTIVE	1.92	1	<a href="#">Check stock or order</a>

## Application Reports

- [DN-42A DESIGN CONSIDERATIONS FOR TRANSITIONING FROM UC3842 TO THE NEW UCC3802 \(SLUA084 - Updated: 12/02/1999\)](#)
- [DN-43 SIMPLE TECHNIQUES TO GENERATE A NEGATIVE VOLTAGE BIAS SUPPLY \(SLUA042 - Updated: 12/02/1999\)](#)
- [DN-46 HIGHLY EFFICIENT LOW POWER DC TO DC INVERTER CONVERTS PLUS5V INPUT TO -3V OUT \(SLUA179 - Updated: 11/04/1999\)](#)

- [U-54001 \(SLUA117 - Updated: 11/04/1999\)](#)
- [DN-48 VERSATILE LOW POWER SEPIC CONVERTER ACCEPTS WIDE INPUT VOLTAGE RANGE](#) (SLUA158 - Updated: 12/02/1999)
- [DN-54 INNOVATIVE BUCK REGULATOR USES HIGH SIDE N-CHANNEL SWITCH WITHOUT COMPLEX](#) (SLUA185 - Updated: 12/02/1999)
- [DN-56A, SINGLE SWITCH FLYBACK CIRCUIT CONVERTS PLUS 5 V TO PLUS/- 12 V FOR RS-232/422](#) (SLUA046 - Updated: 12/02/1999)
- [DN-65 CONSIDERATIONS IN POWERING BICMOS ICS](#) (SLUA081 - Updated: 12/02/1999)
- [ELECTROSTATIC DISCHARGE APPLICATION NOTE](#) (SSYA008 - Updated: 05/05/1999)
- [THERMAL CHARACTERISTICS OF LINEAR AND LOGIC PACKAGES USING JEDEC PCB DESIGNS](#) (SZZA017A - Updated: 09/10/1999)
- [U-133A UCC3800/1/2/3/4/5 BICMOS CURRENT MODE CONTROL IC'S](#) (SLUA149 - Updated: 11/04/1999)

**Table Data Updated on: 8/15/2000**



**TEXAS INSTRUMENTS**

**THE WORLD LEADER IN DSP AND ANALOG**

Advanced Search
TI Home
TI&ME
Employment

Tech Support
Comments
Site Map
TI Global

**Power Management**

Power Management Home

> > [Power Management](#) > [PWM Power Supply Products](#) > [Current Mode](#)



## UCC3801, LOW-POWER BICMOS CURRENT-MODE PWM

Device Status: Active

- > [Description](#)
- > [Features](#)
- > [Datasheets](#)
- > [Pricing/Samples/Availability](#)
- > [Application Notes](#)
- > [Applications](#)

Parameter Name	UCC3801
Shutdown	No
Output Type	Single, Totem Pole
Output Current (mA)	+/-1000
Frequency (max) (kHz)	1000
Pulse - by - Pulse Isense	Yes
Reference Voltage (V)	5
Vref tol (%)	1.5
Startup Current (uA)	100
Duty Cycle (max) (%)	50
Operating Supply Current (mA)	0.5
Operating Supply (max) (V)	12
Operating Supply (min) (V)	7.4
PWM Outputs (#)	1
Error Amplifier GBW (mHz)	2

### Description



The UCC1800/1/2/3/4/5 family of high-speed, low-power integrated circuits contain all of the control and drive components required for off-line and DC-to-DC fixed frequency current-mode switching power supplies with minimal parts count.

These devices have the same pin configuration as the UC1842/3/4/5 family, and also offer the added features of internal full-cycle soft start and internal leading-edge blanking of the current-sense input.

The UCC1800/1/2/3/4/5 family offers a variety of package options, temperature range,

The UCC1800/1/2/3/4/5 family offers a variety of package options, temperature range options, choice of maximum duty cycle, and choice of critical voltage levels. Lower reference parts such as the UCC1803 and UCC1805 fit best into battery operated systems, while the higher reference and the higher UVLO hysteresis of the UCC1802 and UCC1804 make these ideal choices for use in off-line power supplies.

The UCC180x series is specified for operation from  $-55^{\circ}\text{C}$  to  $+125^{\circ}\text{C}$ , the UCC280x series is specified for operation from  $-40^{\circ}\text{C}$  to  $+85^{\circ}\text{C}$ , and the UCC380x series is specified for operation from  $0^{\circ}\text{C}$  to  $+70^{\circ}\text{C}$ .

## Features

- 100uA Typical Starting Supply Current
- 500uA Typical Operating Supply Current
- Operation to 1MHz
- Internal Soft Start
- Internal Fault Soft Start
- Internal Leading-Edge Blanking of the Current Sense Signal
- 1 Amp Totem-Pole Output
- 70ns Typical Response from Current-Sense to Gate Drive Output
- 1.5% Tolerance Voltage Reference
- Same Pinout as UC3842 and UC3842A

To view the following documents, [Acrobat Reader 3.x](#) is required.

To download a document to your hard drive, right-click on the link and choose 'Save'.

## Datasheets

Full datasheet in Acrobat PDF: [slus270.pdf](#) (210 KB)

Full datasheet in Zipped PostScript: [slus270.psz](#) (154 KB)

## Pricing/Samples/Availability

Orderable Device	Package	Pins	Temp (°C)	Status	Price/unit USD (100-999)	Pack Qty	Availability / Samples
UCC3801D	<a href="#">D</a>	8	0 TO 70	ACTIVE	1.95	1	<a href="#">Check stock or order</a>
UCC3801DTR	<a href="#">D</a>	8	0 TO 70	ACTIVE	1.77	1	<a href="#">Check stock or order</a>
UCC3801N	<a href="#">P</a>	8	0 TO 70	ACTIVE	1.91	1	<a href="#">Check stock or order</a>
UCC3801PW	<a href="#">PW</a>	8	0 TO 70	ACTIVE	2.14	1	<a href="#">Check stock or order</a>
UCC3801PWTR	<a href="#">PW</a>	8	0 TO 70	ACTIVE	1.92	1	<a href="#">Check stock or order</a>

## Application Reports

- [CONDITIONING A SWITCH-MODE POWER SUPPLY CURRENT SIGNAL USING TI OP AMPS \(SLOA044 - Updated: 03/26/2000\)](#)
- [DN-42A DESIGN CONSIDERATIONS FOR TRANSITIONING FROM UC3842 TO THE NEW UCC3802 \(SLUA084 - Updated: 12/02/1999\)](#)
- [DN-43 SIMPLE TECHNIQUES TO GENERATE A NEGATIVE VOLTAGE BIAS SUPPLY \(SLOA042 - Updated: 12/02/1999\)](#)

- [SOT111](#) (SLUA072 - Updated: 12/02/1999)
- [DN-46 HIGHLY EFFICIENT LOW POWER DC TO DC INVERTER CONVERTS PLUS5V INPUT TO -3V OUT](#) (SLUA179 - Updated: 11/04/1999)
  - [DN-48 VERSATILE LOW POWER SEPIC CONVERTER ACCEPTS WIDE INPUT VOLTAGE RANGE](#) (SLUA158 - Updated: 12/02/1999)
  - [DN-54 INNOVATIVE BUCK REGULATOR USES HIGH SIDE N-CHANNEL SWITCH WITHOUT COMPLEX](#) (SLUA185 - Updated: 12/02/1999)
  - [DN-56A, SINGLE SWITCH FLYBACK CIRCUIT CONVERTS PLUS 5 V TO PLUS/- 12 V FOR RS-232/422](#) (SLUA046 - Updated: 12/02/1999)
  - [DN-65 CONSIDERATIONS IN POWERING BICMOS ICS](#) (SLUA081 - Updated: 12/02/1999)
  - [ELECTROSTATIC DISCHARGE APPLICATION NOTE](#) (SSYA008 - Updated: 05/05/1999)
  - [THERMAL CHARACTERISTICS OF LINEAR AND LOGIC PACKAGES USING JEDEC PCB DESIGNS](#) (SZZA017A - Updated: 09/10/1999)
  - [U-133A UCC3800/1/2/3/4/5 BICMOS CURRENT MODE CONTROL IC'S](#) (SLUA149 - Updated: 11/04/1999)

**Table Data Updated on: 8/15/2000**



**TEXAS INSTRUMENTS**

**THE WORLD LEADER IN DSP AND ANALOG**

Search Power Portal ▼

▣ Advanced Search
▣ TI Home
▣ TI&ME
▣ Employment

▣ Tech Support
▣ Comments
▣ Site Map
▣ TI Global

**Power Management**

Power Management Home ▼

> > [Power Management](#) > [PWM Power Supply Products](#) > [Current Mode](#)



## UCC3802, LOW-POWER BICMOS CURRENT-MODE PWM

Device Status: Active

- > [Description](#)
- > [Features](#)
- > [Datasheets](#)
- > [Pricing/Samples/Availability](#)
- > [Application Notes](#)
- > [Applications](#)

Parameter Name	UCC3802
Shutdown	No
Output Type	Single, Totem Pole
Output Current (mA)	+/-1000
Frequency (max) (kHz)	1000
Pulse - by - Pulse Isense	Yes
Reference Voltage (V)	5
Vref tol (%)	1.5
Startup Current (uA)	100
Duty Cycle (max) (%)	100
Operating Supply Current (mA)	0.5
Operating Supply (max) (V)	12
Operating Supply (min) (V)	8.3
PWM Outputs (#)	1
Error Amplifier GBW (mHz)	2

### Description



The UCC1800/1/2/3/4/5 family of high-speed, low-power integrated circuits contain all of the control and drive components required for off-line and DC-to-DC fixed frequency current-mode switching power supplies with minimal parts count.

These devices have the same pin configuration as the UC1842/3/4/5 family, and also offer the added features of internal full-cycle soft start and internal leading-edge blanking of the current-sense input.

The UCC1800/1/2/3/4/5 family offers a variety of package options, temperature range



The UCC1800/1/2/3/4/5 family offers a variety of package options, temperature range options, choice of maximum duty cycle, and choice of critical voltage levels. Lower reference parts such as the UCC1803 and UCC1805 fit best into battery operated systems, while the higher reference and the higher UVLO hysteresis of the UCC1802 and UCC1804 make these ideal choices for use in off-line power supplies.

The UCC180x series is specified for operation from  $-55^{\circ}\text{C}$  to  $+125^{\circ}\text{C}$ , the UCC280x series is specified for operation from  $-40^{\circ}\text{C}$  to  $+85^{\circ}\text{C}$ , and the UCC380x series is specified for operation from  $0^{\circ}\text{C}$  to  $+70^{\circ}\text{C}$ .

## Features

- 100uA Typical Starting Supply Current
- 500uA Typical Operating Supply Current
- Operation to 1MHz
- Internal Soft Start
- Internal Fault Soft Start
- Internal Leading-Edge Blanking of the Current Sense Signal
- 1 Amp Totem-Pole Output
- 70ns Typical Response from Current-Sense to Gate Drive Output
- 1.5% Tolerance Voltage Reference
- Same Pinout as UC3842 and UC3842A

To view the following documents, [Acrobat Reader 3.x](#) is required.

To download a document to your hard drive, right-click on the link and choose 'Save'.

## Datasheets

Full datasheet in Acrobat PDF: [slus270.pdf](#) (210 KB)

Full datasheet in Zipped PostScript: [slus270.psz](#) (154 KB)

## Pricing/Samples/Availability

Orderable Device	Package	Pins	Temp (°C)	Status	Price/unit USD (100-999)	Pack Qty	Availability / Samples
UCC3802D	<a href="#">D</a>	8	0 TO 70	ACTIVE	1.95	1	<a href="#">Check stock or order</a>
UCC3802DTR	<a href="#">D</a>	8	0 TO 70	ACTIVE	1.77	1	<a href="#">Check stock or order</a>
UCC3802N	<a href="#">P</a>	8	0 TO 70	ACTIVE	1.91	1	<a href="#">Check stock or order</a>
UCC3802PW	<a href="#">PW</a>	8	0 TO 70	ACTIVE	2.14	1	<a href="#">Check stock or order</a>
UCC3802PWTR	<a href="#">PW</a>	8	0 TO 70	ACTIVE	1.92	1	<a href="#">Check stock or order</a>

## Application Reports

- [CONDITIONING A SWITCH-MODE POWER SUPPLY CURRENT SIGNAL USING TI OP AMPS](#) (SLOA044 - Updated: 03/26/2000)
- [DN-42A DESIGN CONSIDERATIONS FOR TRANSITIONING FROM UC3842 TO THE NEW UCC3802](#) (SLUA084 - Updated: 12/02/1999)
- [DN-43 SIMPLE TECHNIQUES TO GENERATE A NEGATIVE VOLTAGE BIAS](#) (SLOA043 - Updated: 12/02/1999)

- [S1111 \(SLUA072 - Updated: 12/02/1999\)](#)
- [DN-46 HIGHLY EFFICIENT LOW POWER DC TO DC INVERTER CONVERTS PLUS5V INPUT TO -3V OUT \(SLUA179 - Updated: 11/04/1999\)](#)
- [DN-48 VERSATILE LOW POWER SEPIC CONVERTER ACCEPTS WIDE INPUT VOLTAGE RANGE \(SLUA158 - Updated: 12/02/1999\)](#)
- [DN-54 INNOVATIVE BUCK REGULATOR USES HIGH SIDE N-CHANNEL SWITCH WITHOUT COMPLEX \(SLUA185 - Updated: 12/02/1999\)](#)
- [DN-56A, SINGLE SWITCH FLYBACK CIRCUIT CONVERTS PLUS 5 V TO PLUS/- 12 V FOR RS-232/422 \(SLUA046 - Updated: 12/02/1999\)](#)
- [DN-65 CONSIDERATIONS IN POWERING BICMOS ICS \(SLUA081 - Updated: 12/02/1999\)](#)
- [DN-89 COMPARING THE UC3842, UCC3802, AND UCC3809 PRIMARY SIDE PWM CONTROLLERS \(SLUA213 - Updated: 11/04/1999\)](#)
- [ELECTROSTATIC DISCHARGE APPLICATION NOTE \(SSYA008 - Updated: 05/05/1999\)](#)
- [THERMAL CHARACTERISTICS OF LINEAR AND LOGIC PACKAGES USING JEDEC PCB DESIGNS \(SZZA017A - Updated: 09/10/1999\)](#)
- [U-133A UCC3800/1/2/3/4/5 BICMOS CURRENT MODE CONTROL IC'S \(SLUA149 - Updated: 11/04/1999\)](#)

**Table Data Updated on: 8/15/2000**



**TEXAS INSTRUMENTS**

**THE WORLD LEADER IN DSP AND ANALOG**

Advanced Search
TI Home
TI&ME
Employment

Tech Support
Comments
Site Map
TI Global

**Power Management**

Power Management Home

> > [Power Management](#) > [PWM Power Supply Products](#) > [Current Mode](#)



## UCC3804, LOW-POWER BICMOS CURRENT-MODE PWM

Device Status: Active

- > [Description](#)
- > [Features](#)
- > [Datasheets](#)
- > [Pricing/Samples/Availability](#)
- > [Application Notes](#)
- > [Applications](#)

Parameter Name	UCC3804
Shutdown	No
Output Type	Single, Totem Pole
Output Current (mA)	+/-1000
Frequency (max) (kHz)	1000
Pulse - by - Pulse Isense	Yes
Reference Voltage (V)	5
Vref tol (%)	1.5
Startup Current (uA)	100
Duty Cycle (max) (%)	50
Operating Supply Current (mA)	0.5
Operating Supply (max) (V)	12
Operating Supply (min) (V)	8.3
PWM Outputs (#)	1
Error Amplifier GBW (mHz)	2

### Description



The UCC1800/1/2/3/4/5 family of high-speed, low-power integrated circuits contain all of the control and drive components required for off-line and DC-to-DC fixed frequency current-mode switching power supplies with minimal parts count.

These devices have the same pin configuration as the UC1842/3/4/5 family, and also offer the added features of internal full-cycle soft start and internal leading-edge blanking of the current-sense input.

The UCC1800/1/2/3/4/5 family offers a variety of package options, temperature range,

The UCC1800/1/2/3/4/5 family offers a variety of package options, temperature range options, choice of maximum duty cycle, and choice of critical voltage levels. Lower reference parts such as the UCC1803 and UCC1805 fit best into battery operated systems, while the higher reference and the higher UVLO hysteresis of the UCC1802 and UCC1804 make these ideal choices for use in off-line power supplies.

The UCC180x series is specified for operation from  $-55^{\circ}\text{C}$  to  $+125^{\circ}\text{C}$ , the UCC280x series is specified for operation from  $-40^{\circ}\text{C}$  to  $+85^{\circ}\text{C}$ , and the UCC380x series is specified for operation from  $0^{\circ}\text{C}$  to  $+70^{\circ}\text{C}$ .

## Features

- 100uA Typical Starting Supply Current
- 500uA Typical Operating Supply Current
- Operation to 1MHz
- Internal Soft Start
- Internal Fault Soft Start
- Internal Leading-Edge Blanking of the Current Sense Signal
- 1 Amp Totem-Pole Output
- 70ns Typical Response from Current-Sense to Gate Drive Output
- 1.5% Tolerance Voltage Reference
- Same Pinout as UC3842 and UC3842A

To view the following documents, [Acrobat Reader 3.x](#) is required.

To download a document to your hard drive, right-click on the link and choose 'Save'.

## Datasheets

Full datasheet in Acrobat PDF: [slus270.pdf](#) (210 KB)

Full datasheet in Zipped PostScript: [slus270.psz](#) (154 KB)

## Pricing/Samples/Availability

Orderable Device	Package	Pins	Temp (°C)	Status	Price/unit USD (100-999)	Pack Qty	Availability / Samples
UCC3804D	<a href="#">D</a>	8	0 TO 70	ACTIVE	1.95	1	<a href="#">Check stock or order</a>
UCC3804DTR	<a href="#">D</a>	8	0 TO 70	ACTIVE	1.77	1	<a href="#">Check stock or order</a>
UCC3804N	<a href="#">P</a>	8	0 TO 70	ACTIVE	1.91	1	<a href="#">Check stock or order</a>
UCC3804PW	<a href="#">PW</a>	8	0 TO 70	ACTIVE	2.14	1	<a href="#">Check stock or order</a>
UCC3804PWTR	<a href="#">PW</a>	8	0 TO 70	ACTIVE	1.92	1	<a href="#">Check stock or order</a>

## Application Reports

- [CONDITIONING A SWITCH-MODE POWER SUPPLY CURRENT SIGNAL USING TI OP AMPS \(SLOA044 - Updated: 03/26/2000\)](#)
- [DN-42A DESIGN CONSIDERATIONS FOR TRANSITIONING FROM UC3842 TO THE NEW UCC3802 \(SLUA084 - Updated: 12/02/1999\)](#)
- [DN-43 SIMPLE TECHNIQUES TO GENERATE A NEGATIVE VOLTAGE BIAS SUPPLY \(SLOA042 - Updated: 12/02/1999\)](#)

- [SOT111 \(SLUA072 - Updated: 12/02/1999\)](#)
- [DN-46 HIGHLY EFFICIENT LOW POWER DC TO DC INVERTER CONVERTS PLUS5V INPUT TO -3V OUT](#) (SLUA179 - Updated: 11/04/1999)
  - [DN-48 VERSATILE LOW POWER SEPIC CONVERTER ACCEPTS WIDE INPUT VOLTAGE RANGE](#) (SLUA158 - Updated: 12/02/1999)
  - [DN-54 INNOVATIVE BUCK REGULATOR USES HIGH SIDE N-CHANNEL SWITCH WITHOUT COMPLEX](#) (SLUA185 - Updated: 12/02/1999)
  - [DN-56A, SINGLE SWITCH FLYBACK CIRCUIT CONVERTS PLUS 5 V TO PLUS/- 12 V FOR RS-232/422](#) (SLUA046 - Updated: 12/02/1999)
  - [DN-65 CONSIDERATIONS IN POWERING BICMOS ICS](#) (SLUA081 - Updated: 12/02/1999)
  - [ELECTROSTATIC DISCHARGE APPLICATION NOTE](#) (SSYA008 - Updated: 05/05/1999)
  - [THERMAL CHARACTERISTICS OF LINEAR AND LOGIC PACKAGES USING JEDEC PCB DESIGNS](#) (SZZA017A - Updated: 09/10/1999)
  - [U-133A UCC3800/1/2/3/4/5 BICMOS CURRENT MODE CONTROL IC'S](#) (SLUA149 - Updated: 11/04/1999)

**Table Data Updated on: 8/15/2000**



**TEXAS INSTRUMENTS**

**THE WORLD LEADER IN DSP AND ANALOG**

Search Power Portal ▼

▣ Advanced Search
▣ TI Home
▣ TI&ME
▣ Employment

▣ Tech Support
▣ Comments
▣ Site Map
▣ TI Global

**Power Management**

Power Management Home ▼

> > [Power Management](#) > [PWM Power Supply Products](#) > [Current Mode](#)



## UCC3805, LOW-POWER BICMOS CURRENT-MODE PWM

Device Status: Active

- > [Description](#)
- > [Features](#)
- > [Datasheets](#)
- > [Pricing/Samples/Availability](#)
- > [Application Notes](#)
- > [Applications](#)

Parameter Name	UCC3805
Shutdown	No
Output Type	Single, Totem Pole
Output Current (mA)	+/-1000
Frequency (max) (kHz)	1000
Pulse - by - Pulse Isense	Yes
Reference Voltage (V)	4
Vref tol (%)	1.5
Startup Current (uA)	100
Duty Cycle (max) (%)	50
Operating Supply Current (mA)	0.5
Operating Supply (max) (V)	12
Operating Supply (min) (V)	3.6
PWM Outputs (#)	1
Error Amplifier GBW (mHz)	2

### Description



The UCC1800/1/2/3/4/5 family of high-speed, low-power integrated circuits contain all of the control and drive components required for off-line and DC-to-DC fixed frequency current-mode switching power supplies with minimal parts count.

These devices have the same pin configuration as the UC1842/3/4/5 family, and also offer the added features of internal full-cycle soft start and internal leading-edge blanking of the current-sense input.

The UCC1800/1/2/3/4/5 family offers a variety of package options, temperature range

The UCC1800/1/2/3/4/5 family offers a variety of package options, temperature range options, choice of maximum duty cycle, and choice of critical voltage levels. Lower reference parts such as the UCC1803 and UCC1805 fit best into battery operated systems, while the higher reference and the higher UVLO hysteresis of the UCC1802 and UCC1804 make these ideal choices for use in off-line power supplies.

The UCC180x series is specified for operation from  $-55^{\circ}\text{C}$  to  $+125^{\circ}\text{C}$ , the UCC280x series is specified for operation from  $-40^{\circ}\text{C}$  to  $+85^{\circ}\text{C}$ , and the UCC380x series is specified for operation from  $0^{\circ}\text{C}$  to  $+70^{\circ}\text{C}$ .

## Features

- 100uA Typical Starting Supply Current
- 500uA Typical Operating Supply Current
- Operation to 1MHz
- Internal Soft Start
- Internal Fault Soft Start
- Internal Leading-Edge Blanking of the Current Sense Signal
- 1 Amp Totem-Pole Output
- 70ns Typical Response from Current-Sense to Gate Drive Output
- 1.5% Tolerance Voltage Reference
- Same Pinout as UC3842 and UC3842A

To view the following documents, [Acrobat Reader 3.x](#) is required.

To download a document to your hard drive, right-click on the link and choose 'Save'.

## Datasheets

Full datasheet in Acrobat PDF: [slus270.pdf](#) (210 KB)

Full datasheet in Zipped PostScript: [slus270.psz](#) (154 KB)

## Pricing/Samples/Availability

Orderable Device	Package	Pins	Temp (°C)	Status	Price/unit USD (100-999)	Pack Qty	Availability / Samples
UCC3805D	<a href="#">D</a>	8	0 TO 70	ACTIVE	1.95	1	<a href="#">Check stock or order</a>
UCC3805DTR	<a href="#">D</a>	8	0 TO 70	ACTIVE	1.77	1	<a href="#">Check stock or order</a>
UCC3805N	<a href="#">P</a>	8	0 TO 70	ACTIVE	1.91	1	<a href="#">Check stock or order</a>
UCC3805PW	<a href="#">PW</a>	8	0 TO 70	ACTIVE	2.14	1	<a href="#">Check stock or order</a>
UCC3805PWTR	<a href="#">PW</a>	8	0 TO 70	ACTIVE	1.92	1	<a href="#">Check stock or order</a>

## Application Reports

- [CONDITIONING A SWITCH-MODE POWER SUPPLY CURRENT SIGNAL USING TI OP AMPS](#) (SLOA044 - Updated: 03/26/2000)
- [DN-42A DESIGN CONSIDERATIONS FOR TRANSITIONING FROM UC3842 TO THE NEW UCC3802](#) (SLUA084 - Updated: 12/02/1999)
- [DN-43 SIMPLE TECHNIQUES TO GENERATE A NEGATIVE VOLTAGE BIAS](#) (SLOA043 - Updated: 12/02/1999)



- [SOT111](#) (SLUA072 - Updated: 12/02/1999)
- [DN-46 HIGHLY EFFICIENT LOW POWER DC TO DC INVERTER CONVERTS PLUS5V INPUT TO -3V OUT](#) (SLUA179 - Updated: 11/04/1999)
  - [DN-48 VERSATILE LOW POWER SEPIC CONVERTER ACCEPTS WIDE INPUT VOLTAGE RANGE](#) (SLUA158 - Updated: 12/02/1999)
  - [DN-54 INNOVATIVE BUCK REGULATOR USES HIGH SIDE N-CHANNEL SWITCH WITHOUT COMPLEX](#) (SLUA185 - Updated: 12/02/1999)
  - [DN-56A, SINGLE SWITCH FLYBACK CIRCUIT CONVERTS PLUS 5 V TO PLUS/- 12 V FOR RS-232/422](#) (SLUA046 - Updated: 12/02/1999)
  - [DN-65 CONSIDERATIONS IN POWERING BICMOS ICS](#) (SLUA081 - Updated: 12/02/1999)
  - [ELECTROSTATIC DISCHARGE APPLICATION NOTE](#) (SSYA008 - Updated: 05/05/1999)
  - [THERMAL CHARACTERISTICS OF LINEAR AND LOGIC PACKAGES USING JEDEC PCB DESIGNS](#) (SZZA017A - Updated: 09/10/1999)
  - [U-133A UCC3800/1/2/3/4/5 BICMOS CURRENT MODE CONTROL IC'S](#) (SLUA149 - Updated: 11/04/1999)

**Table Data Updated on: 8/15/2000**