

National Semiconductor is now part of  
Texas Instruments.

Search <http://www.ti.com/> for the latest technical  
information and details on our current products and services.

## LP3878-ADJ

# Micropower 800mA Low Noise "Ceramic Stable" Adjustable Voltage Regulator for 1V to 5V Applications

### General Description

The LP3878-ADJ is an 800 mA adjustable output voltage regulator designed to provide high performance and low noise in applications requiring output voltages as low as 1.0V.

Using an optimized VIP® (Vertically Integrated PNP) process, the LP3878-ADJ delivers superior performance:

**Ground Pin Current:** Typically 5.5 mA @ 800 mA load, and 180  $\mu$ A @ 100  $\mu$ A load.

**Low Power Shutdown:** The LP3878-ADJ draws less than 10  $\mu$ A quiescent current when shutdown pin is pulled low.

**Precision Output:** Guaranteed output voltage accuracy is 1% at room temperature.

**Low Noise:** Broadband output noise is only 18  $\mu$ V (typical) with 10 nF bypass capacitor.

### Features

- 1.0V to 5.5V output
- Designed for use with low ESR ceramic capacitors
- Very low output noise
- 8 Lead PSOP and LLP surface mount package
- <10  $\mu$ A quiescent current in shutdown
- Low ground pin current at all loads
- Over-temperature/over-current protection
- -40°C to +125°C operating junction temperature range

### Applications

- ASIC Power Supplies In:
  - Desktops, Notebooks and Graphic Cards
  - Set Top Boxes, Printers and Copiers
- DSP and FPGA Power Supplies
- SMPS Post-Regulator
- Medical Instrumentation

### Basic Application Circuit

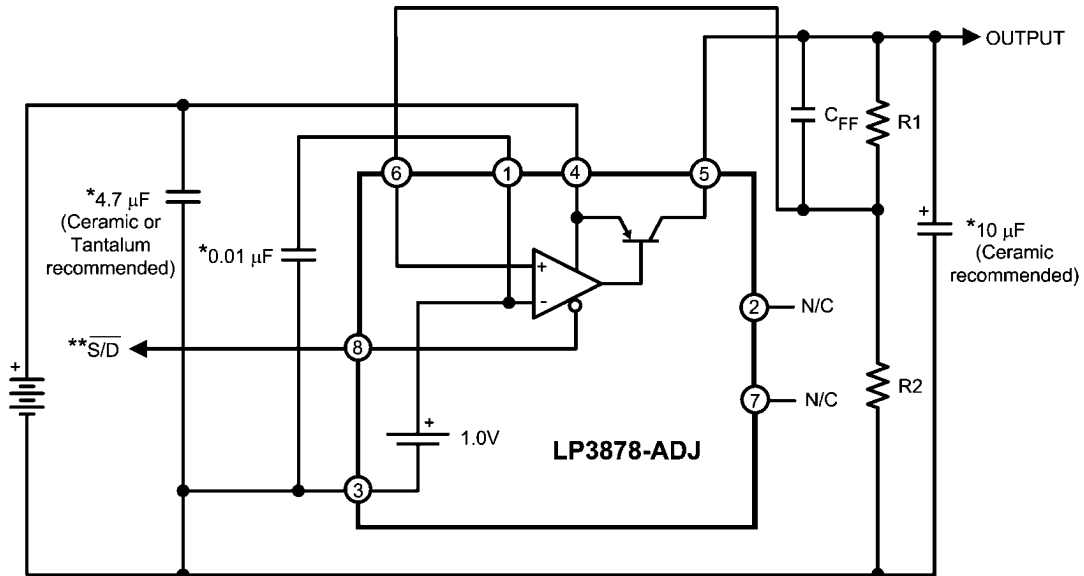

20120903

\*Capacitance values shown are minimum required to assure stability. Larger output capacitor provides improved dynamic response. Output capacitor must meet ESR requirements (see Application Information).

\*\*The Shutdown pin must be actively terminated (see Application Information). Tie to INPUT (Pin 4) if not used.

## Connection Diagrams

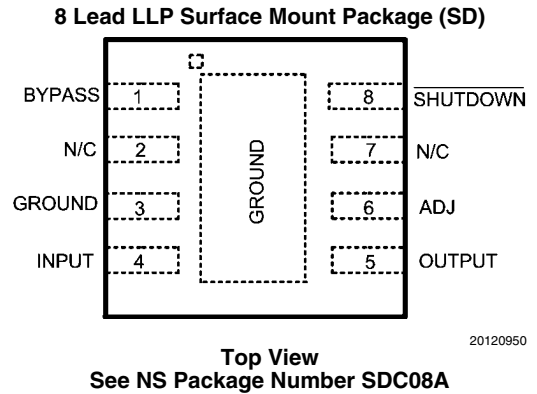
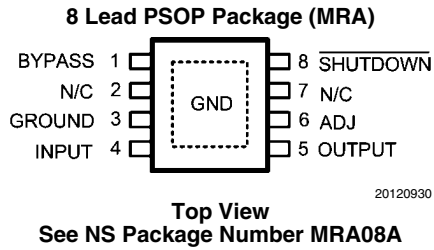

## Ordering Information

TABLE 1. Package Marking and Ordering Information

Output Voltage	Grade	Order Information	Supplied as:
ADJ	STD	LP3878MR-ADJ	95 Units per Rail
ADJ	STD	LP3878MRX-ADJ	2500 Units on Tape and Reel
ADJ	STD	LP3878SD-ADJ	1000 Units on Tape and Reel
ADJ	STD	LP3878SDX-ADJ	4500 Units on Tape and Reel

## Pin Descriptions

Pin	Name	Function
1	BYPASS	The capacitor connected between BYPASS and GROUND lowers output noise voltage level and is required for loop stability.
2	N/C	DO NOT CONNECT. This pin is used for post package test and must be left floating.
3	GROUND	Device ground.
4	INPUT	Input source voltage.
5	OUTPUT	Regulated output voltage.
6	ADJ	Provides feedback to error amplifier from the resistive divider that sets the output voltage.
7	N/C	No internal connection.
8	SHUTDOWN	Output is enabled above turn-on threshold voltage. Pull down to turn off regulator output.
PSOP, LLP DAP	SUBSTRATE GROUND	The exposed die attach pad should be connected to a thermal pad at ground potential. For additional information on using National Semiconductor's Non Pull Back LLP package, please refer to LLP application note AN-1187

## Absolute Maximum Ratings (Note 1)

If Military/Aerospace specified devices are required, please contact the National Semiconductor Sales Office/Distributors for availability and specifications.

Storage Temperature Range	-65°C to +150°C
Operating Junction Temperature Range	-40°C to +125°C
Lead Temperature (Soldering, 5 seconds)	260°C
ESD Rating (Note 2)	2 kV
Shutdown Pin	1kV

Power Dissipation (Note 3)	Internally Limited
Input Supply Voltage (Survival)	-0.3V to +16V
Input Supply Voltage (Typical Operating)	2.5V to +16V
ADJ Pin	-0.3V to +6V
Output Voltage (Survival) (Note 4)	-0.3V to +6V
I <sub>OUT</sub> (Survival)	Short Circuit Protected
Input-Output Voltage (Survival) (Note 5)	-0.3V to +16V

## Electrical Characteristics

Limits in standard typeface are for T<sub>J</sub> = 25°C, and limits in **boldface type** apply over the temperature range of -40°C to 125°C. Limits are guaranteed through design, testing, or correlation. The limits are used to calculate National's Average Outgoing Quality Level (AOQL). Unless otherwise specified: V<sub>IN</sub> = 3.0V, V<sub>OUT</sub> = 1V, I<sub>L</sub> = 1 mA, C<sub>OUT</sub> = 10 μF, C<sub>IN</sub> = 4.7 μF, V<sub>S/D</sub> = 2V, C<sub>BYPASS</sub> = 10 nF.

Symbol	Parameter	Conditions	Min	Typical	Max	Units
V <sub>ADJ</sub>	Adjust Pin Voltage		0.99	1.00	1.01	V
		1 mA ≤ I <sub>L</sub> ≤ 800 mA 3.0V ≤ V <sub>IN</sub> ≤ 6V	0.98 <b>0.97</b>	1.00	1.02 <b>1.03</b>	
$\frac{\Delta V_{OUT}}{\Delta V_{IN}}$	Output Voltage Line Regulation	3.0V ≤ V <sub>IN</sub> ≤ 16V		0.007	0.014 <b>0.032</b>	%/V
V <sub>IN</sub> (min)	Minimum Input Voltage Required To Maintain Output Regulation	I <sub>L</sub> = 800 mA V <sub>OUT</sub> ≥ V <sub>OUT(NOM)</sub> - 1%		2.5	<b>3.1</b>	V
		I <sub>L</sub> = 800 mA V <sub>OUT</sub> ≥ V <sub>OUT(NOM)</sub> - 1% 0 ≤ T <sub>J</sub> ≤ 125°C		2.5	<b>2.8</b>	
		I <sub>L</sub> = 750 mA V <sub>OUT</sub> ≥ V <sub>OUT(NOM)</sub> - 1%		2.5	<b>3.0</b>	
V <sub>DO</sub>	Dropout Voltage (Note 6) V <sub>OUT</sub> = 3.8V	I <sub>L</sub> = 100 μA		1	2 <b>3</b>	mV
		I <sub>L</sub> = 200 mA		150	200 <b>300</b>	
		I <sub>L</sub> = 800 mA		475	600 <b>1100</b>	
I <sub>GND</sub>	Ground Pin Current	I <sub>L</sub> = 100 μA		180	200 <b>225</b>	μA
		I <sub>L</sub> = 200 mA		1.5	2 <b>3.5</b>	mA
		I <sub>L</sub> = 800 mA		5.5	8.5 <b>15</b>	
I <sub>O(PK)</sub>	Peak Output Current	V <sub>OUT</sub> ≥ V <sub>OUT(NOM)</sub> - 5%		1200		mA
I <sub>O(MAX)</sub>	Short Circuit Current	R <sub>L</sub> = 0 (Steady State)		1300		
e <sub>n</sub>	Output Noise Voltage (RMS)	BW = 100 Hz to 100 kHz C <sub>BYPASS</sub> = 10 nF		18		μV(RMS)
$\frac{\Delta V_{OUT}}{\Delta V_{IN}}$	Ripple Rejection	f = 1 kHz		60		dB
I <sub>ADJ</sub>	ADJ Pin Bias Current (Sourcing)	I <sub>L</sub> = 800 mA		200		nA

Symbol	Parameter	Conditions	Min	Typical	Max	Units
<b>SHUTDOWN INPUT</b>						
V <sub>S/D</sub>	S/D Input Voltage	V <sub>H</sub> = Output ON		1.4	<b>1.6</b>	V
		V <sub>L</sub> = Output OFF I <sub>IN</sub> ≤ 10 μA	<b>0.04</b>	0.20		
		V <sub>OUT</sub> ≤ 10 mV I <sub>IN</sub> ≤ 50 μA		0.6		
I <sub>S/D</sub>	S/D Input Current	V <sub>S/D</sub> = 0		0.02	<b>-1</b>	μA
		V <sub>S/D</sub> = 5V		5	<b>15</b>	

**Note 1:** Absolute Maximum Ratings indicate limits beyond which damage to the component may occur. Electrical specifications do not apply when operating the device outside of its rated operating conditions.

**Note 2:** ESD testing was performed using Human Body Model, a 100 pF capacitor discharged through a 1.5 kΩ resistor.

**Note 3:** The maximum allowable power dissipation is a function of the maximum junction temperature, T<sub>J</sub>(MAX), the junction-to-ambient thermal resistance, θ<sub>J-A</sub>, and the ambient temperature, T<sub>A</sub>. The maximum allowable power dissipation at any ambient temperature is calculated using:

$$P (MAX) = \frac{T_J (MAX) - T_A}{\theta_{J-A}}$$

The value of θ<sub>J-A</sub> for the LLP (SD) and PSOP (MRA) packages are specifically dependent on PCB trace area, trace material, and the number of layers and thermal vias. If a four layer board is used with maximum vias from the IC center to the heat dissipating copper layers, values of θ<sub>J-A</sub> which can be obtained are approximately 60°C/W for the PSOP-8 and 40°C/W for the LLP-8 package. For improved thermal resistance and power dissipation for the LLP package, refer to Application Note AN-1187. Exceeding the maximum allowable power dissipation will cause excessive die temperature, and the regulator will go into thermal shutdown.

**Note 4:** If used in a dual-supply system where the regulator load is returned to a negative supply, the LP3878-ADJ output must be diode-clamped to ground.

**Note 5:** The output PNP structure contains a diode between the V<sub>IN</sub> and V<sub>OUT</sub> terminals that is normally reverse-biased. Forcing the output above the input will turn on this diode and may induce a latch-up mode which can damage the part (see Application Hints).

**Note 6:** Dropout voltage spec applies only if V<sub>IN</sub> is sufficient so that it does not limit regulator operation.

**Typical Performance Characteristics** Unless otherwise specified:  $V_{IN} = 3.3V$ ,  $V_{OUT} = 1V$ ,  $I_L = 1\text{ mA}$ ,  $C_{IN} = 4.7\ \mu F$ ,  $C_{OUT} = 10\ \mu F$ ,  $V_{SD} = 2V$ ,  $C_{BYP} = 10\ \text{nF}$ ,  $T_J = 25^\circ C$ .

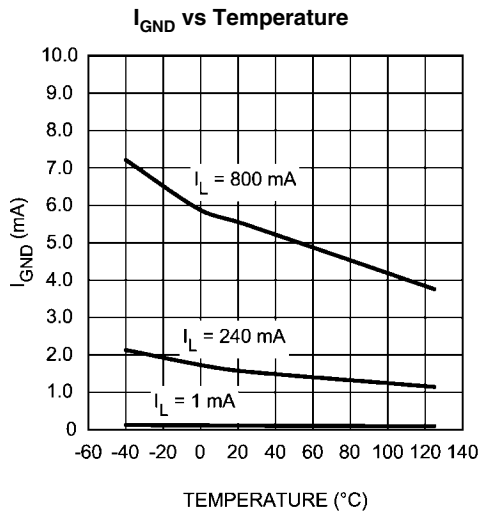

20120920

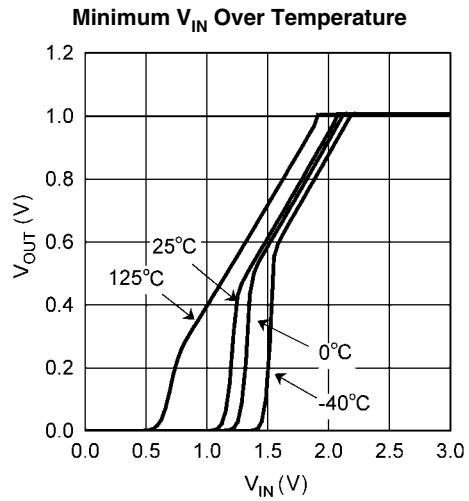

20120921

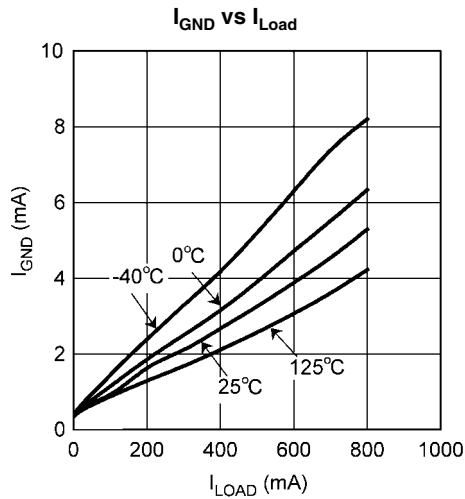

20120922

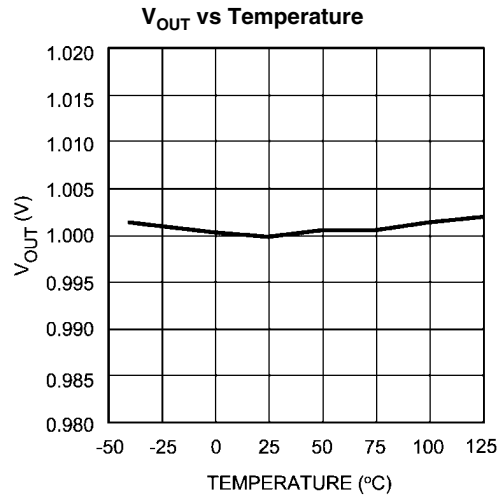

20120959

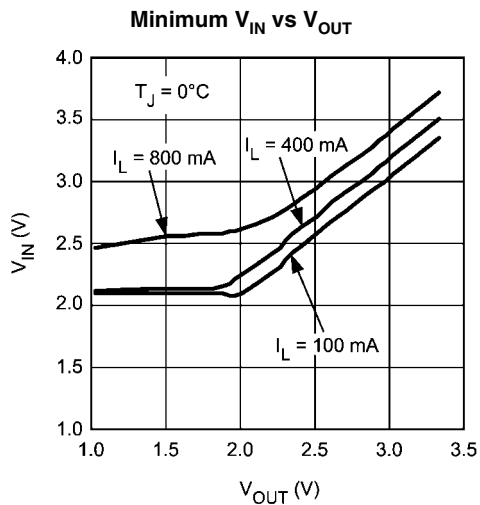

20120951

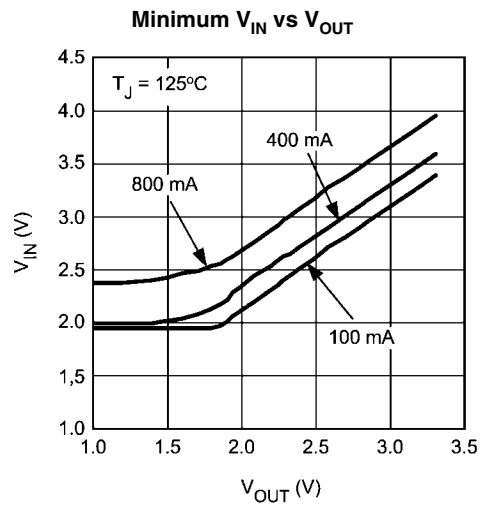

20120952

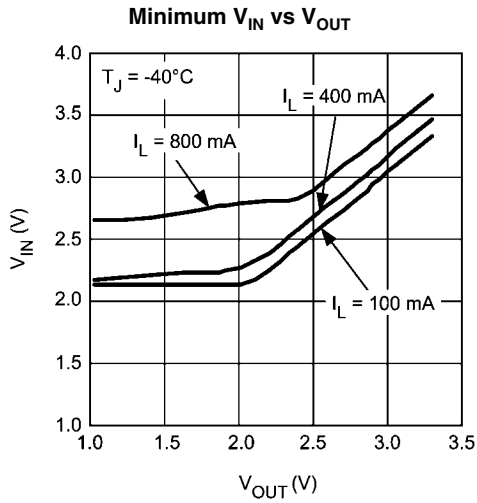

20120953

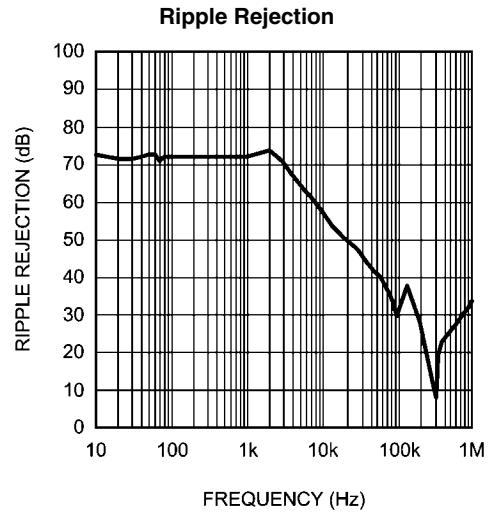

20120954

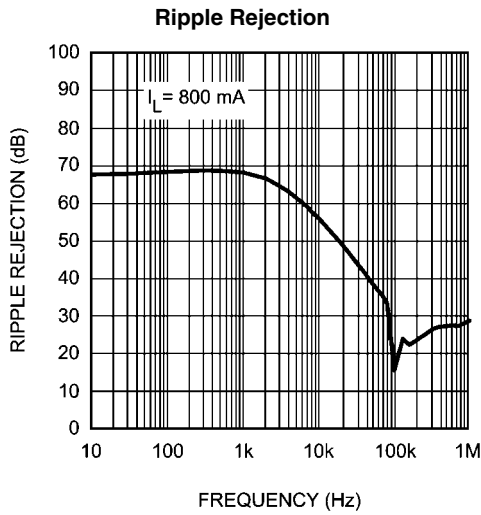

20120958

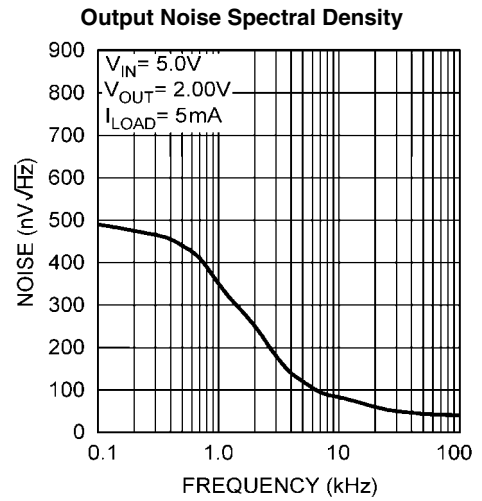

20120947

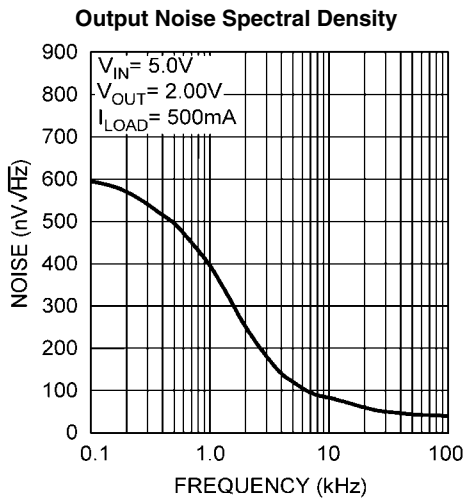

20120948

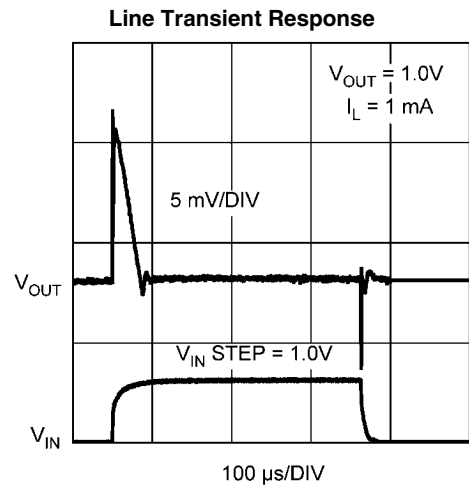

20120931

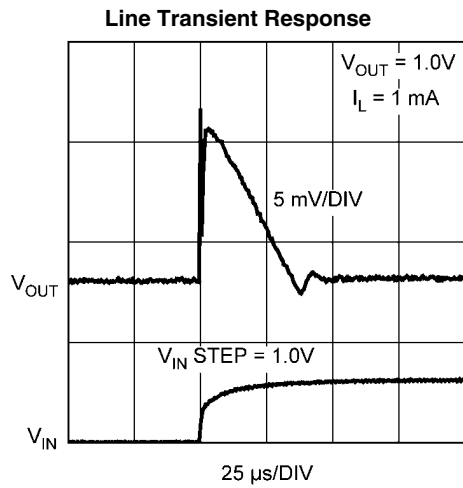

20120933

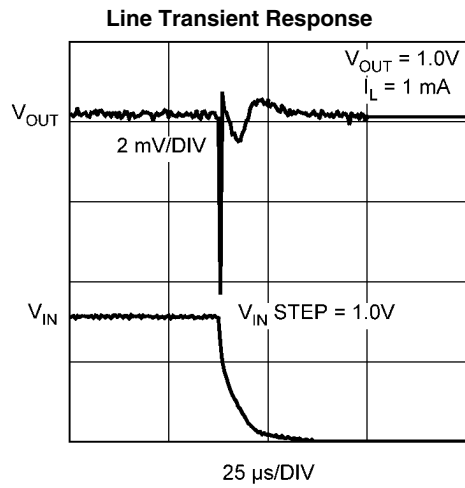

20120932

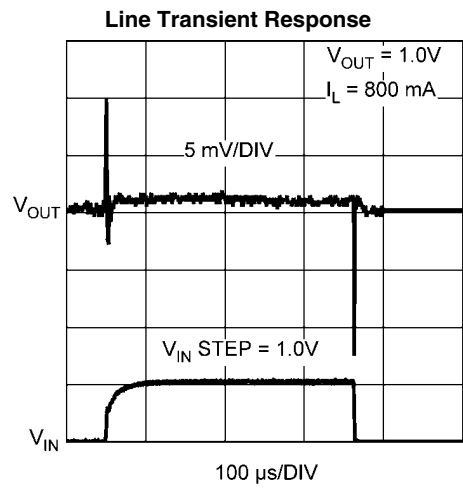

20120935

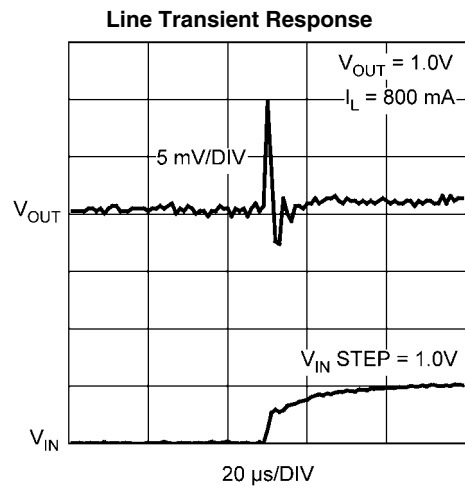

20120936

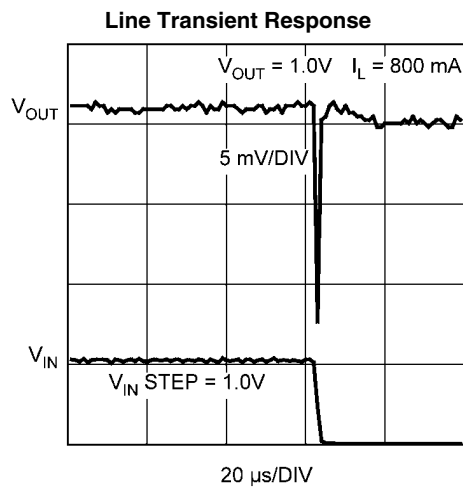

20120934

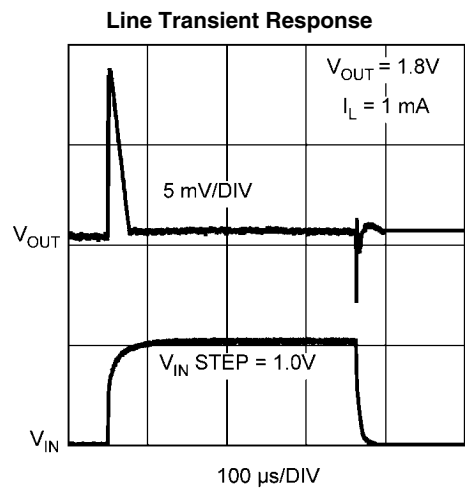

20120937



Line Transient Response

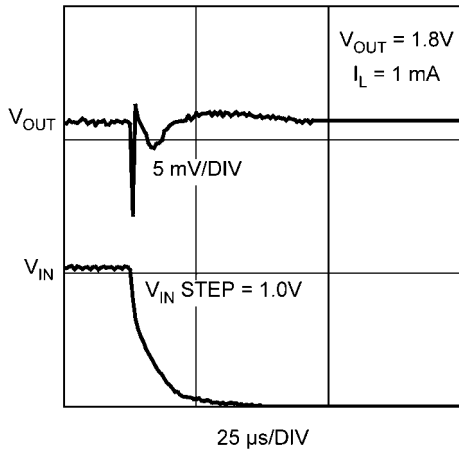

20120939

Line Transient Response

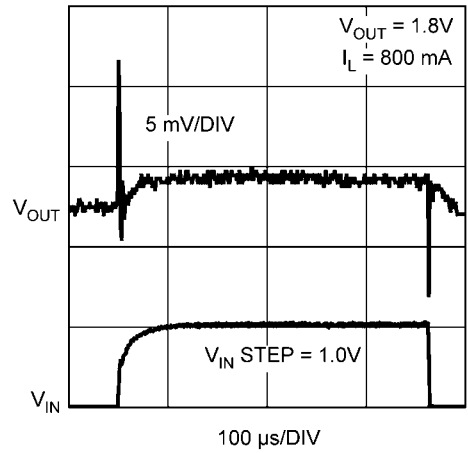

20120940

Line Transient Response

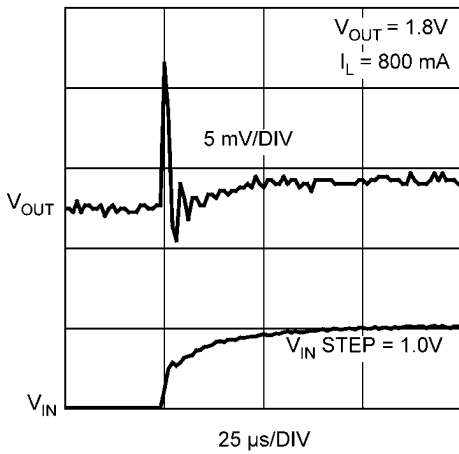

20120942

Line Transient Response

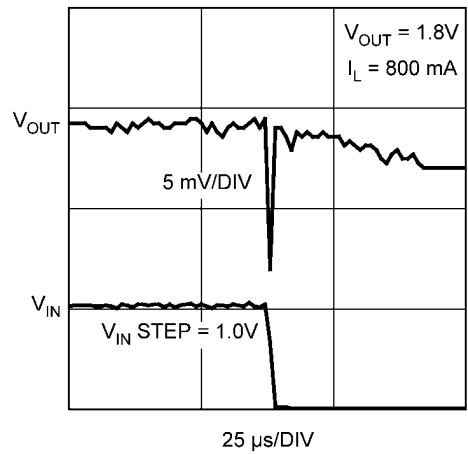

20120941

Load Transient Response

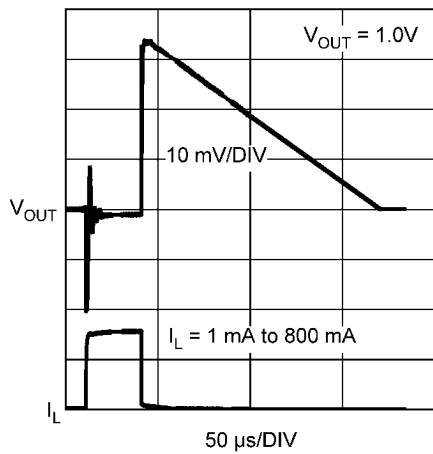

20120945

Load Transient Response

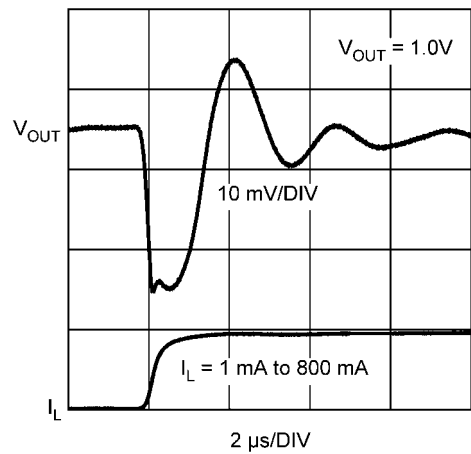

20120943

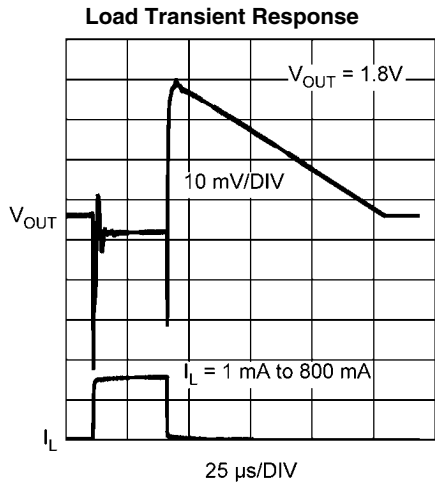

20120946

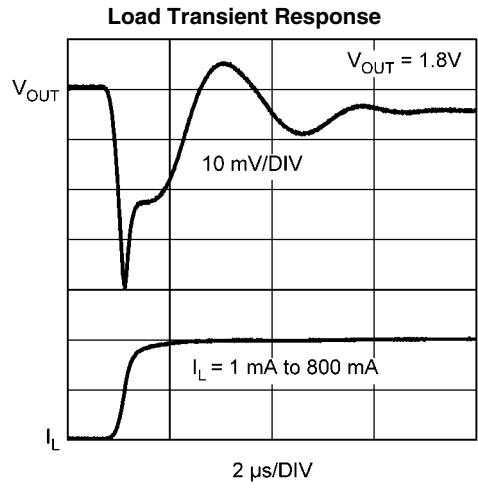

20120944

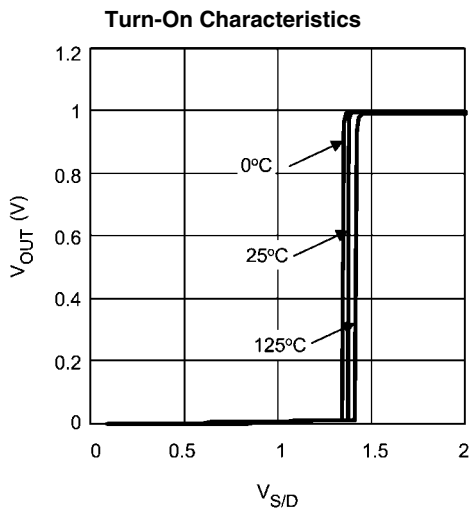

20120955

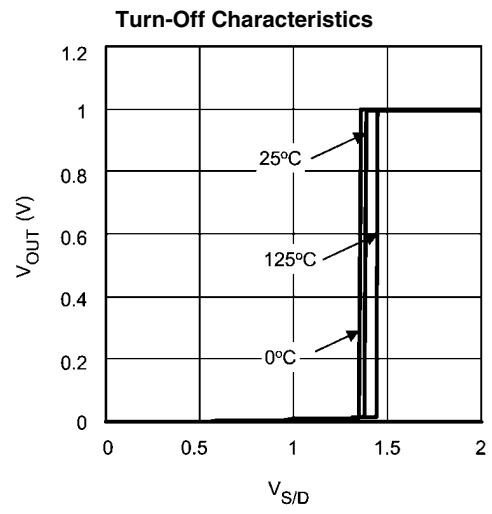

20120956

## Block Diagram

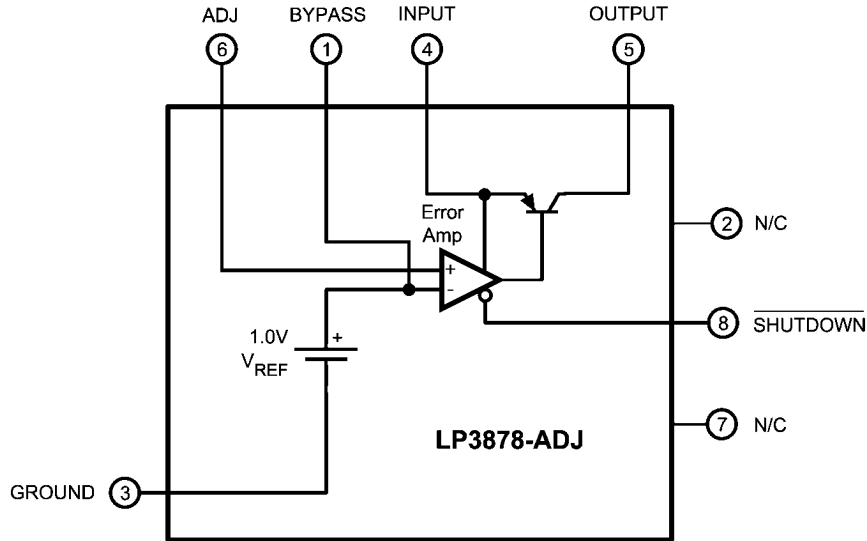

20120901

## Application Information

### PACKAGE INFORMATION

The LP3878-ADJ is offered in the 8 lead PSOP or LLP surface mount packages to allow for increased power dissipation compared to the SO-8 and Mini SO-8. For details on thermal performance as well as mounting and soldering specifications, refer to Application Note AN-1187.

### EXTERNAL CAPACITORS

Like any low-dropout regulator, the LP3878-ADJ requires external capacitors for regulator stability. These capacitors must be correctly selected for good performance.

**INPUT CAPACITOR:** A capacitor whose value is at least 4.7  $\mu\text{F}$  ( $\pm 20\%$ ) is required between the LP3878-ADJ input and ground. A good quality X5R / X7R ceramic capacitor should be used.

Capacitor tolerance and temperature variation must be considered when selecting a capacitor (see **Capacitor Characteristics** section) to assure the minimum requirement of input capacitance is met over all operating conditions.

The input capacitor must be located not more than 0.5" from the input pin and returned to a clean analog ground. Any good quality ceramic or tantalum capacitor may be used, assuming the minimum input capacitance requirement is met.

**OUTPUT CAPACITOR:** The LP3878-ADJ requires a ceramic output capacitor whose size is at least 10  $\mu\text{F}$  ( $\pm 20\%$ ). A good quality X5R / X7R ceramic capacitor should be used. Capacitance tolerance and temperature characteristics must be considered when selecting an output capacitor.

The LP3878-ADJ is designed specifically to work with ceramic output capacitors, utilizing circuitry which allows the regulator to be stable across the entire range of output current with an ultra low ESR output capacitor.

The output capacitor selected must meet the requirement for minimum amount of capacitance and also have an ESR (equivalent series resistance) value which is within the stable range. A curve is provided which shows the stable ESR range as a function of load current (see *Figure 1*).

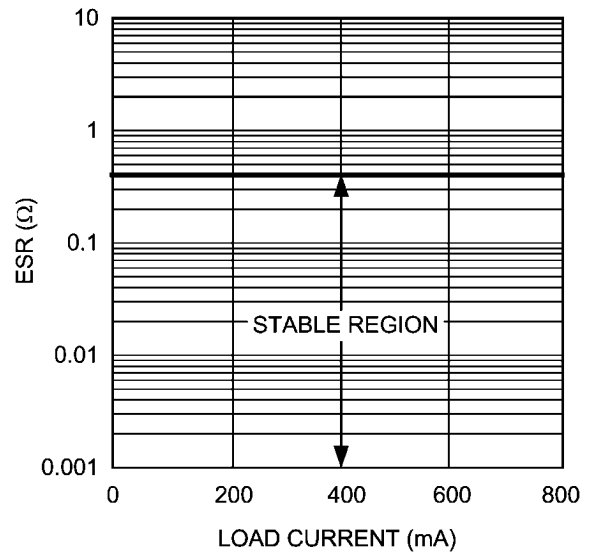

20120938

**FIGURE 1. Stable Region For Output Capacitor ESR**

**Important:** The output capacitor must maintain its ESR within the stable region *over the full operating temperature range of the application* to assure stability.

The output capacitor ESR forms a zero which is required to add phase lead near the loop gain crossover frequency, typically in the range of 50kHz to 200 kHz. The ESR at lower frequencies is of no importance. Some capacitor manufacturers list ESR at low frequencies only, and some give a formula for Dissipation Factor which can be used to calculate a value for a term referred to as ESR. However, since the DF formula is usually at a much lower frequency than the range listed above, it will give an unrealistically high value. If good quality X5R or X7R ceramic capacitors are used, the actual ESR in the 50 kHz to 200 kHz range will not exceed 25 milli

Ohms. If these are used as output capacitors for the LP3878-ADJ, the regulator stability requirements are satisfied.

It is important to remember that capacitor tolerance and variation with temperature must be taken into consideration when selecting an output capacitor so that the minimum required amount of output capacitance is provided over the full operating temperature range. (See Capacitor Characteristics section).

The output capacitor must be located not more than 0.5" from the output pin and returned to a clean analog ground.

**NOISE BYPASS CAPACITOR:** The 10 nF capacitor on the Bypass pin significantly reduces noise on the regulator output and is required for loop stability. However, the capacitor is connected directly to a high-impedance circuit in the bandgap reference.

Because this circuit has only a few microamperes flowing in it, any significant loading on this node will cause a change in the regulated output voltage. For this reason, DC leakage current through the noise bypass capacitor must never exceed 100 nA, and should be kept as low as possible for best output voltage accuracy.

The types of capacitors best suited for the noise bypass capacitor are ceramic and film. High-quality ceramic capacitors with either NPO or COG dielectric typically have very low leakage. 10 nF polypropylene and polycarbonate film capacitors are available in small surface-mount packages and typically have extremely low leakage current.

#### FEEDFORWARD CAPACITOR

The feedforward capacitor designated  $C_{FF}$  in the Basic Application circuit is required to increase phase margin and assure loop stability. Improved phase margin also gives better transient response to changes in load or input voltage, and faster settling time on the output voltage when transients occur.  $C_{FF}$  forms both a pole and zero in the loop gain, the zero providing beneficial phase lead (which increases phase margin) and the pole adding undesirable phase lag (which should be minimized). The zero frequency is determined both by the value of  $C_{FF}$  and  $R1$ :

$$f_z = 1 / (2 \times \pi \times C_{FF} \times R1)$$

The pole frequency resulting from  $C_{FF}$  is determined by the value of  $C_{FF}$  and the parallel combination of  $R1$  and  $R2$ :

$$f_p = 1 / (2 \times \pi \times C_{FF} \times (R1 // R2))$$

At higher output voltages where  $R1$  is much greater than  $R2$ , the value of  $R2$  primarily determines the value of the parallel combination of  $R1 // R2$ . This puts the pole at a much higher frequency than the zero. As the regulated output voltage is reduced (and the value of  $R1$  decreases), the parallel effect of  $R2$  diminishes and the two equations become equal (at which point the pole and zero cancel out). Because the pole frequency gets closer to the zero at lower output voltages, the beneficial effects of  $C_{FF}$  are increased if the frequency range of the zero is shifted slightly higher for applications with low  $V_{out}$  (because then the pole adds less phase lag at the loop's crossover frequency).

$C_{FF}$  should be selected to place the pole zero pair at a frequency where the net phase lead added to the loop at the crossover frequency is maximized. The following design guidelines were obtained from bench testing to optimize phase margin, transient response, and settling time:

**For  $V_{out} \leq 2.5V$ :**  $C_{FF}$  should be selected to set the zero frequency in the range of about 50 kHz to 200 kHz.

**For  $V_{out} > 2.5V$ :**  $C_{FF}$  should be selected to set the zero frequency in the range of about 20 kHz to 100 kHz.

#### CAPACITOR CHARACTERISTICS

**CERAMIC:** The LP3878-ADJ was designed to work with ceramic capacitors on the output to take advantage of the benefits they offer: for capacitance values in the 10  $\mu F$  range, ceramics are the least expensive and also have the lowest ESR values (which makes them best for eliminating high-frequency noise). The ESR of a typical 10  $\mu F$  ceramic capacitor is in the range of 5 m $\Omega$  to 10 m $\Omega$ , which meets the ESR limits required for stability by the LP3878-ADJ.

One disadvantage of ceramic capacitors is that their capacitance can vary with temperature. Many large value ceramic capacitors ( $\geq 2.2 \mu F$ ) are manufactured with the Z5U or Y5V temperature characteristic, which results in the capacitance dropping by more than 50% as the temperature goes from 25° C to 85°C.

Another significant problem with Z5U and Y5V dielectric devices is that the capacitance drops severely with applied voltage. A typical Z5U or Y5V capacitor can lose 60% of its rated capacitance with half of the rated voltage applied to it.

**For these reasons, X7R and X5R type ceramic capacitors must be used on the input and output of the LP3878-ADJ.**

#### SHUTDOWN INPUT OPERATION

The LP3878-ADJ is shut off by pulling the Shutdown input low, and turned on by pulling it high. If this feature is not to be used, the Shutdown input should be tied to  $V_{IN}$  to keep the regulator output on at all times.

To assure proper operation, the signal source used to drive the Shutdown input must be able to swing above and below the specified turn-on/turn-off voltage thresholds listed in the Electrical Characteristics section under  $V_{ON/OFF}$ .

#### REVERSE INPUT-OUTPUT VOLTAGE

The PNP power transistor used as the pass element in the LP3878-ADJ has an inherent diode connected between the regulator output and input.

During normal operation (where the input voltage is higher than the output) this diode is reverse-biased.

However, if the output is pulled above the input, this diode will turn ON and current will flow into the regulator output.

In such cases, a parasitic SCR can latch which will allow a high current to flow into  $V_{IN}$  (and out the ground pin), which can damage the part.

In any application where the output may be pulled above the input, an external Schottky diode must be connected from  $V_{IN}$  to  $V_{OUT}$  (cathode on  $V_{IN}$ , anode on  $V_{OUT}$ ), to limit the reverse voltage across the LP3878-ADJ to 0.3V (see Absolute Maximum Ratings).

#### SETTING THE OUTPUT VOLTAGE

The output voltage is set using resistors  $R1$  and  $R2$  (see Basic Application Circuit).

The formula for output voltage is:

$$V_{OUT} = V_{ADJ} \times (1 + (R1 / R2))$$

$R2$  must be less than 5 k $\Omega$  to ensure loop stability.

To prevent voltage errors,  $R1$  and  $R2$  must be located near the LP3878-ADJ and connected via traces with no other currents flowing in them (Kelvin connect). The bottom of the  $R1/R2$  divider must be connected directly to the LP3878-ADJ ground pin.

**Physical Dimensions** inches (millimeters) unless otherwise noted

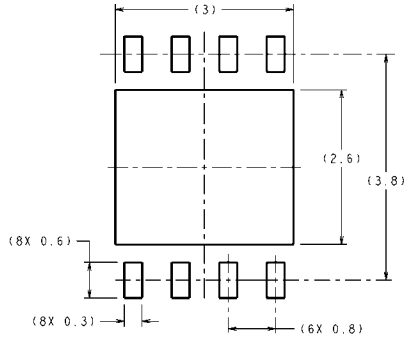

DIMENSIONS ARE IN MILLIMETERS  
DIMENSIONS IN ( ) FOR REFERENCE ONLY



**RECOMMENDED LAND PATTERN**

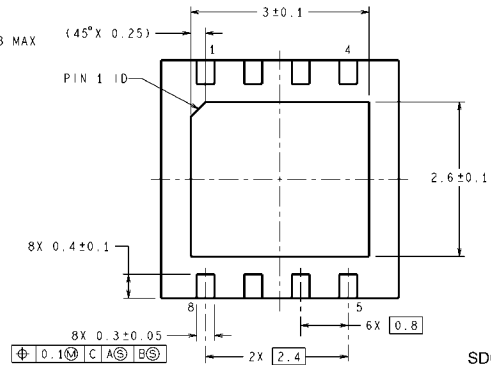
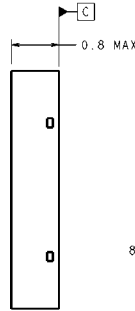
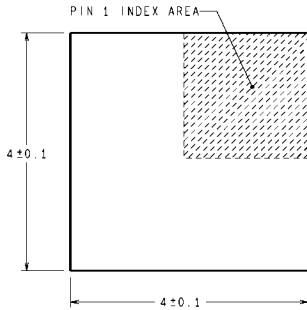

SDC08A (Rev A)

**8 Lead LLP Surface Mount Package**  
**NS Package Number SDC08A**

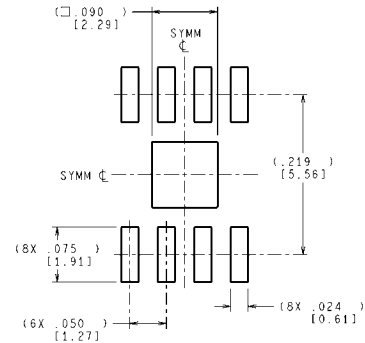
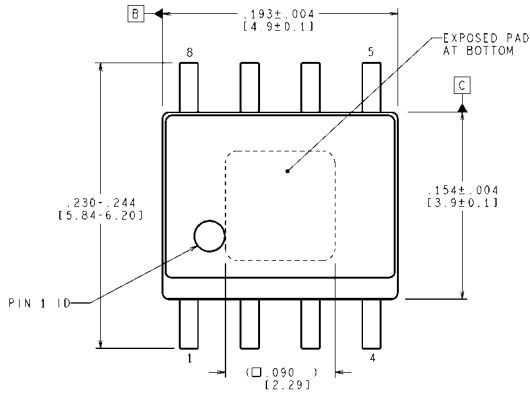

**RECOMMENDED LAND PATTERN**

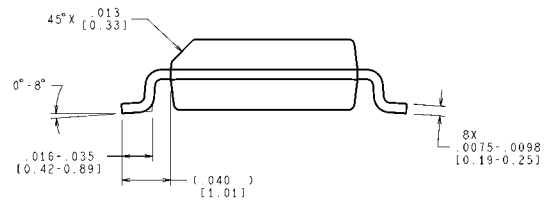
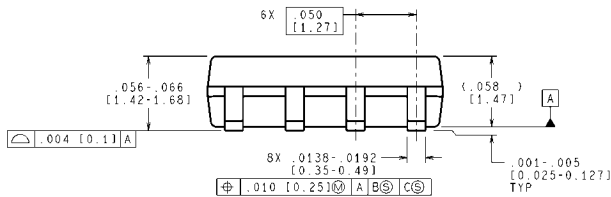

CONTROLLING DIMENSION IS INCH  
VALUES IN [ ] ARE MILLIMETERS  
DIMENSIONS IN ( ) FOR REFERENCE ONLY

**8-Lead PSOP Package (PSOP-8)**  
**NS Package Number MRA08A**

MRA08A (Rev D)

# Notes

## Notes

For more National Semiconductor product information and proven design tools, visit the following Web sites at:

Products		Design Support	
Amplifiers	<a href="http://www.national.com/amplifiers">www.national.com/amplifiers</a>	WEBENCH® Tools	<a href="http://www.national.com/webench">www.national.com/webench</a>
Audio	<a href="http://www.national.com/audio">www.national.com/audio</a>	App Notes	<a href="http://www.national.com/appnotes">www.national.com/appnotes</a>
Clock and Timing	<a href="http://www.national.com/timing">www.national.com/timing</a>	Reference Designs	<a href="http://www.national.com/refdesigns">www.national.com/refdesigns</a>
Data Converters	<a href="http://www.national.com/adc">www.national.com/adc</a>	Samples	<a href="http://www.national.com/samples">www.national.com/samples</a>
Interface	<a href="http://www.national.com/interface">www.national.com/interface</a>	Eval Boards	<a href="http://www.national.com/evalboards">www.national.com/evalboards</a>
LVDS	<a href="http://www.national.com/lvds">www.national.com/lvds</a>	Packaging	<a href="http://www.national.com/packaging">www.national.com/packaging</a>
Power Management	<a href="http://www.national.com/power">www.national.com/power</a>	Green Compliance	<a href="http://www.national.com/quality/green">www.national.com/quality/green</a>
Switching Regulators	<a href="http://www.national.com/switchers">www.national.com/switchers</a>	Distributors	<a href="http://www.national.com/contacts">www.national.com/contacts</a>
LDOs	<a href="http://www.national.com/ldo">www.national.com/ldo</a>	Quality and Reliability	<a href="http://www.national.com/quality">www.national.com/quality</a>
LED Lighting	<a href="http://www.national.com/led">www.national.com/led</a>	Feedback/Support	<a href="http://www.national.com/feedback">www.national.com/feedback</a>
Voltage Reference	<a href="http://www.national.com/vref">www.national.com/vref</a>	Design Made Easy	<a href="http://www.national.com/easy">www.national.com/easy</a>
PowerWise® Solutions	<a href="http://www.national.com/powerwise">www.national.com/powerwise</a>	Solutions	<a href="http://www.national.com/solutions">www.national.com/solutions</a>
Serial Digital Interface (SDI)	<a href="http://www.national.com/sdi">www.national.com/sdi</a>	Mil/Aero	<a href="http://www.national.com/milaero">www.national.com/milaero</a>
Temperature Sensors	<a href="http://www.national.com/tempensors">www.national.com/tempensors</a>	SolarMagic™	<a href="http://www.national.com/solarmagic">www.national.com/solarmagic</a>
Wireless (PLL/VCO)	<a href="http://www.national.com/wireless">www.national.com/wireless</a>	PowerWise® Design University	<a href="http://www.national.com/training">www.national.com/training</a>

THE CONTENTS OF THIS DOCUMENT ARE PROVIDED IN CONNECTION WITH NATIONAL SEMICONDUCTOR CORPORATION ("NATIONAL") PRODUCTS. NATIONAL MAKES NO REPRESENTATIONS OR WARRANTIES WITH RESPECT TO THE ACCURACY OR COMPLETENESS OF THE CONTENTS OF THIS PUBLICATION AND RESERVES THE RIGHT TO MAKE CHANGES TO SPECIFICATIONS AND PRODUCT DESCRIPTIONS AT ANY TIME WITHOUT NOTICE. NO LICENSE, WHETHER EXPRESS, IMPLIED, ARISING BY ESTOPPEL OR OTHERWISE, TO ANY INTELLECTUAL PROPERTY RIGHTS IS GRANTED BY THIS DOCUMENT.

TESTING AND OTHER QUALITY CONTROLS ARE USED TO THE EXTENT NATIONAL DEEMS NECESSARY TO SUPPORT NATIONAL'S PRODUCT WARRANTY. EXCEPT WHERE MANDATED BY GOVERNMENT REQUIREMENTS, TESTING OF ALL PARAMETERS OF EACH PRODUCT IS NOT NECESSARILY PERFORMED. NATIONAL ASSUMES NO LIABILITY FOR APPLICATIONS ASSISTANCE OR BUYER PRODUCT DESIGN. BUYERS ARE RESPONSIBLE FOR THEIR PRODUCTS AND APPLICATIONS USING NATIONAL COMPONENTS. PRIOR TO USING OR DISTRIBUTING ANY PRODUCTS THAT INCLUDE NATIONAL COMPONENTS, BUYERS SHOULD PROVIDE ADEQUATE DESIGN, TESTING AND OPERATING SAFEGUARDS.

EXCEPT AS PROVIDED IN NATIONAL'S TERMS AND CONDITIONS OF SALE FOR SUCH PRODUCTS, NATIONAL ASSUMES NO LIABILITY WHATSOEVER, AND NATIONAL DISCLAIMS ANY EXPRESS OR IMPLIED WARRANTY RELATING TO THE SALE AND/OR USE OF NATIONAL PRODUCTS INCLUDING LIABILITY OR WARRANTIES RELATING TO FITNESS FOR A PARTICULAR PURPOSE, MERCHANTABILITY, OR INFRINGEMENT OF ANY PATENT, COPYRIGHT OR OTHER INTELLECTUAL PROPERTY RIGHT.

### LIFE SUPPORT POLICY

**NATIONAL'S PRODUCTS ARE NOT AUTHORIZED FOR USE AS CRITICAL COMPONENTS IN LIFE SUPPORT DEVICES OR SYSTEMS WITHOUT THE EXPRESS PRIOR WRITTEN APPROVAL OF THE CHIEF EXECUTIVE OFFICER AND GENERAL COUNSEL OF NATIONAL SEMICONDUCTOR CORPORATION.** As used herein:

Life support devices or systems are devices which (a) are intended for surgical implant into the body, or (b) support or sustain life and whose failure to perform when properly used in accordance with instructions for use provided in the labeling can be reasonably expected to result in a significant injury to the user. A critical component is any component in a life support device or system whose failure to perform can be reasonably expected to cause the failure of the life support device or system or to affect its safety or effectiveness.

National Semiconductor and the National Semiconductor logo are registered trademarks of National Semiconductor Corporation. All other brand or product names may be trademarks or registered trademarks of their respective holders.

Copyright© 2009 National Semiconductor Corporation

For the most current product information visit us at [www.national.com](http://www.national.com)



**National Semiconductor Americas Technical Support Center**  
Email: [support@nsc.com](mailto:support@nsc.com)  
Tel: 1-800-272-9959

**National Semiconductor Europe Technical Support Center**  
Email: [europe.support@nsc.com](mailto:europe.support@nsc.com)

**National Semiconductor Asia Pacific Technical Support Center**  
Email: [ap.support@nsc.com](mailto:ap.support@nsc.com)

**National Semiconductor Japan Technical Support Center**  
Email: [jpn.feedback@nsc.com](mailto:jpn.feedback@nsc.com)