

Typical Applications

The HMC194AMS8 /HMC194AMS8E is ideal for:

- Cellular/PCS Base Stations
- Portable Wireless
- MMDS & WirelessLAN

Features

- Ultra Small Package: MSOP8
- High Isolation: 50 dB
- Positive Control: 0/+3V to 0/+7V

Functional Diagram

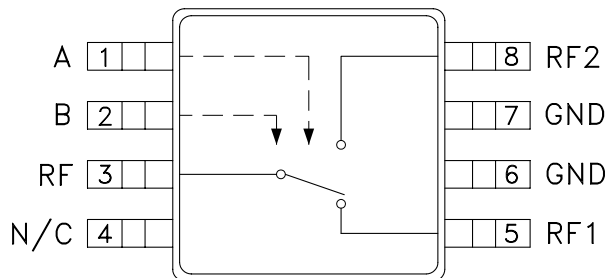

General Description

The HMC194AMS8 & HMC194AMS8E are low-cost SPDT switches in 8-lead MSOP packages for use in applications which require high isolation between two RF paths. The devices can control signals from DC to 3 GHz and have been optimized to provide extremely high isolation with minimal insertion loss in medium and low power applications. On chip circuitry allows positive voltage control operation at very low DC currents with control inputs compatible with CMOS and most TTL logic families. RF1 and RF2 are reflective opens when "OFF".

Electrical Specifications, $T_A = +25^\circ\text{C}$, $V_{ctl} = 0/+5\text{Vdc}$, 50 Ohm System

Parameter	Frequency	Min.	Typ.	Max.	Units
Insertion Loss	DC - 2.0 GHz		0.5	0.9	dB
	DC - 2.5 GHz		0.5	1.0	dB
	DC - 3.0 GHz		0.5	1.1	dB
Isolation	DC - 1.0 GHz	50	55		dB
	DC - 2.0 GHz	42	45		dB
	DC - 2.5 GHz	31	38		dB
	DC - 3.0 GHz	24	30		dB
Return Loss	DC - 2.0 GHz		26		dB
	DC - 3.0 GHz		24		dB
Input Power for 1 dB Compression 0/+5V Control	0.5 - 3.0 GHz	24	28		dBm
Input Third Order Intercept (Two-tone Input Power = +7 dBm Each Tone) 0/+5V Control	0.5 - 3.0 GHz	49	53		dBm
Switching Characteristics	DC - 3.0 GHz				
		tRISE, tFALL (10/90% RF) tON, tOFF (50% CTL to 10/90% RF)		3 20	ns ns



Insertion Loss

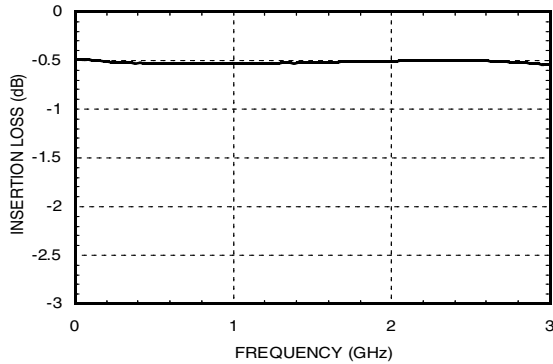

Isolation

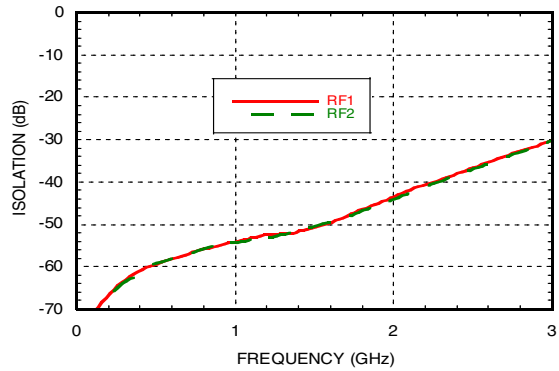

Return Loss

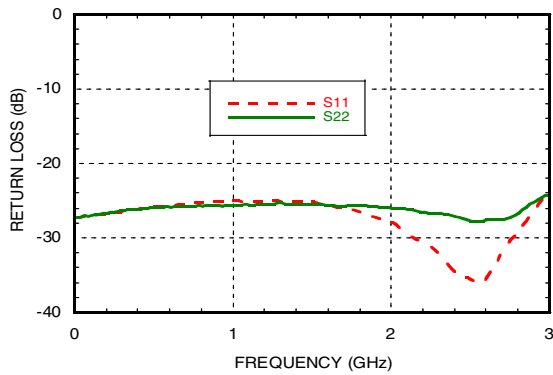

Input 0.1 and 1.0 dB Compression vs. Control Voltage

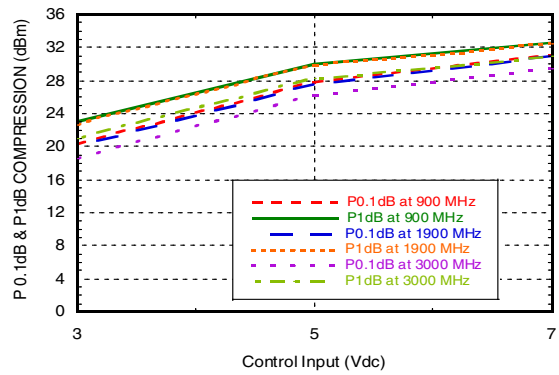

Input Third Order Intercept Point vs. Control Voltage

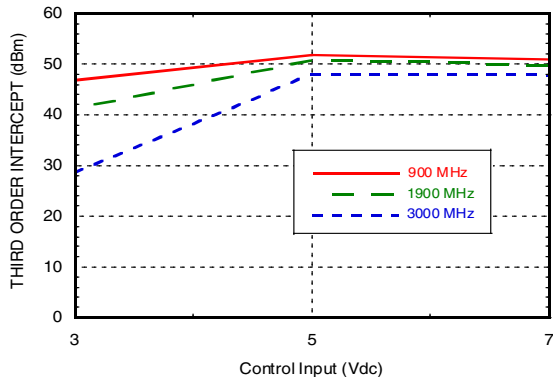

Truth Table

*Control Input Voltage Tolerances are ± 0.2 Vdc.

Control Input*		Control Current		Signal Path State	
A (Vdc)	B (Vdc)	Ia (uA)	Ib (uA)	RF to RF1	RF to RF2
0	+3	-0.05	+0.05	ON	OFF
+3	0	+0.05	-0.05	OFF	ON
0	+5	-0.6	+0.6	ON	OFF
+5	0	+0.6	-0.6	OFF	ON
0	+7	-5	+5	ON	OFF
+7	0	+5	-5	OFF	ON

Absolute Maximum Ratings

RF Input Power (Vctl= 0V/+5V)	+27 dBm
Control Voltage Range (A & B)	-0.2 to +7.5 Vdc
Hot Switch Power Level (Vctl= 0V/+5V)	+24 dBm
Channel Temperature	150 °C
Continuous Pdiss (T= 85 °C) (derate 4.6 mW/°C above 85 °C)	300 mW
Thermal Resistance	216 °C/W
Storage Temperature	-65 to +150 °C
Operating Temperature	-40 to +85 °C
ESD Sensitivity (HBM)	Class 1A

Note: DC blocking capacitors are required at ports RFC, RF1 and RF2. Their value will determine the lowest transmission frequency.



ELECTROSTATIC SENSITIVE DEVICE
OBSERVE HANDLING PRECAUTIONS

Outline Drawing

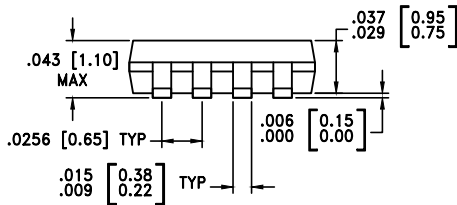
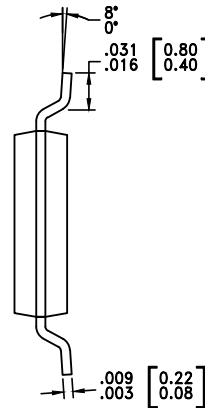
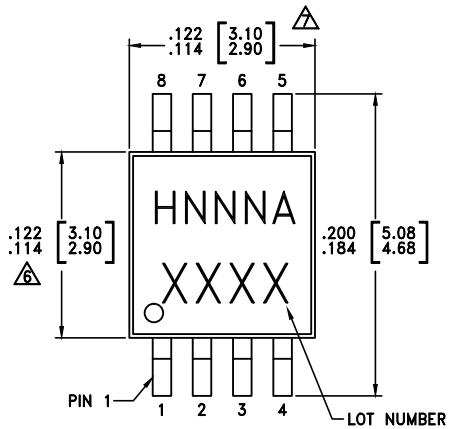

NOTES:

1. LEADFRAME MATERIAL: COPPER ALLOY
2. DIMENSIONS ARE IN INCHES [MILLIMETERS].
3. DIMENSION DOES NOT INCLUDE MOLDFLASH OF 0.15mm PER SIDE.
4. DIMENSION DOES NOT INCLUDE MOLDFLASH OF 0.25mm PER SIDE.
5. ALL GROUND LEADS MUST BE SOLDERED TO PCB RF GROUND.
6. CLASSIFIED AS MOISTURE SENSITIVITY LEVEL (MSL) 1.

Package Information

Part Number	Package Body Material	Lead Finish	MSL Rating	Package Marking ^[3]
HMC194AMS8	Low Stress Injection Molded Plastic	Sn/Pb Solder	MSL1 ^[1]	H194A XXXX
HMC194AMS8E	RoHS-compliant Low Stress Injection Molded Plastic	100% matte Sn	MSL1 ^[2]	H194A XXXX

[1] Max peak reflow temperature of 235 °C

[2] Max peak reflow temperature of 260 °C

[3] 4-Digit lot number XXXX

Typical Application Circuit

Notes:

1. Set logic gate and switch Vdd = +3V to +5V and use HCT series logic to provide a TTL driver interface.
2. Control inputs A/B can be driven directly with CMOS logic (HC) with Vdd of 3 to 7 Volts applied to the CMOS logic gates.
3. DC Blocking capacitors are required for each RF port as shown. Capacitor value determines lowest frequency of operation.
4. Highest RF signal power capability is achieved with Control set to 0/+7V.

Evaluation Circuit Board

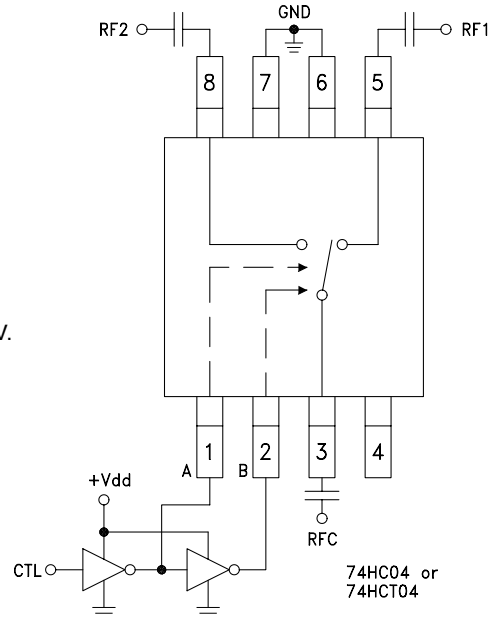
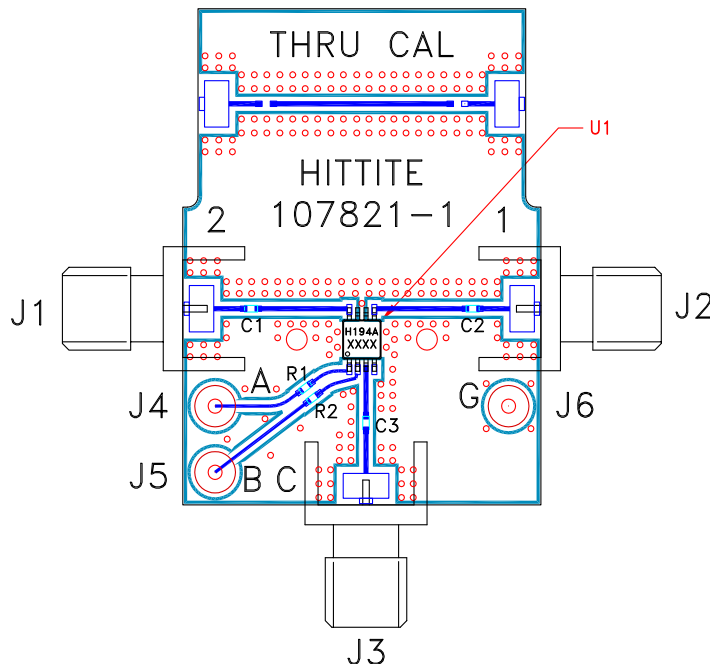

List of Materials for Evaluation PCB 105143 [1]

Item	Description
J1 - J3	PC Mount SMA RF Connector
J4 - J6	DC Pin
C1 - C3	100 pF capacitor, 0402 Pkg.
R1, R2	100 Ω resistor, 0402 Pkg.
U1	HMC194AMS8 / 194AMS8E SPDT Switch
PCB [2]	107821 Evaluation PCB

[1] Reference this number when ordering complete evaluation PCB

[2] Circuit Board Material: Rogers 4350

The circuit board used in the final application should be generated with proper RF circuit design techniques. Signal lines at the RF port should have 50 Ohm impedance and the package ground leads should be connected directly to the ground plane similar to that shown above. The evaluation circuit board shown above is available from Hittite Microwave Corporation upon request.