

National Semiconductor is now part of
Texas Instruments.

Search <http://www.ti.com/> for the latest technical
information and details on our current products and services.

LM4980 Boomer® Audio Power Amplifier Series

2 Cell Battery, 1mA, 42mW Per Channel High Fidelity Stereo Headphone Audio Amplifier for MP3 players

General Description

The LM4980 is a stereo headphone audio amplifier, which when connected to a 3.0V supply, delivers 42mW to a 16Ω load with less than 1% THD+N. With the LM4980 packaged in the SD package, the customer benefits include low profile and small size. This package minimizes PCB area and maximizes output power.

The LM4980 features circuitry that significantly reduces output transients (“clicks” and “pops”) while driving headphones during device turn-on and turn-off without costly external additional circuitry. The LM4980 also includes an externally controlled low-power consumption active-low shutdown mode, and thermal shutdown. Boomer audio power amplifiers are designed specifically to use few external components and provide high quality output power in a surface mount package.

Key Specifications

- Output power (RL = 16Ω, V_{DD} = 3.0V, THD+N = 1%) 42mW (typ)
- Quiescent current (V_{DD} = 3V) 1mA (typ)
- Micropower shutdown current 0.1μA (typ)
- Supply voltage operating range 1.5V < V_{DD} < 3.3V
- PSRR @ 1kHz, V_{DD} = 3.0V 90dB (typ)
- PSRR @ 217Hz, V_{DD} = 3.0V 100dB (typ)

Features

- 2-cell 1.5V to 3.3V battery operation
- Unity-gain stable
- “Click and pop” suppression circuitry for shutdown and power on/off transient with headphone loads
- Active low micro-power shutdown
- Thermal shutdown protection circuitry

Applications

- Portable two-cell audio products
- Portable two-cell electronic devices
- Portable MP3 player/recorders

Typical Application

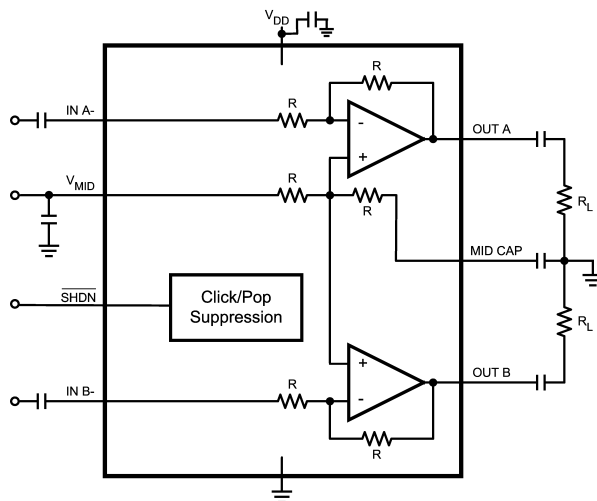

20142901

FIGURE 1. Block Diagram

Boomer® is a registered trademark of National Semiconductor Corporation.

Connection Diagram

SD Package

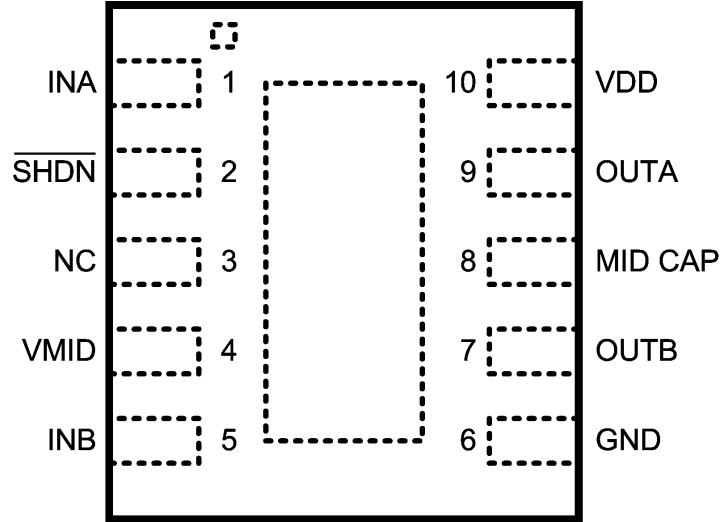

20142902

Top View
Order Number LM4980SD
See NS Package Number SDA10A

Typical Connection

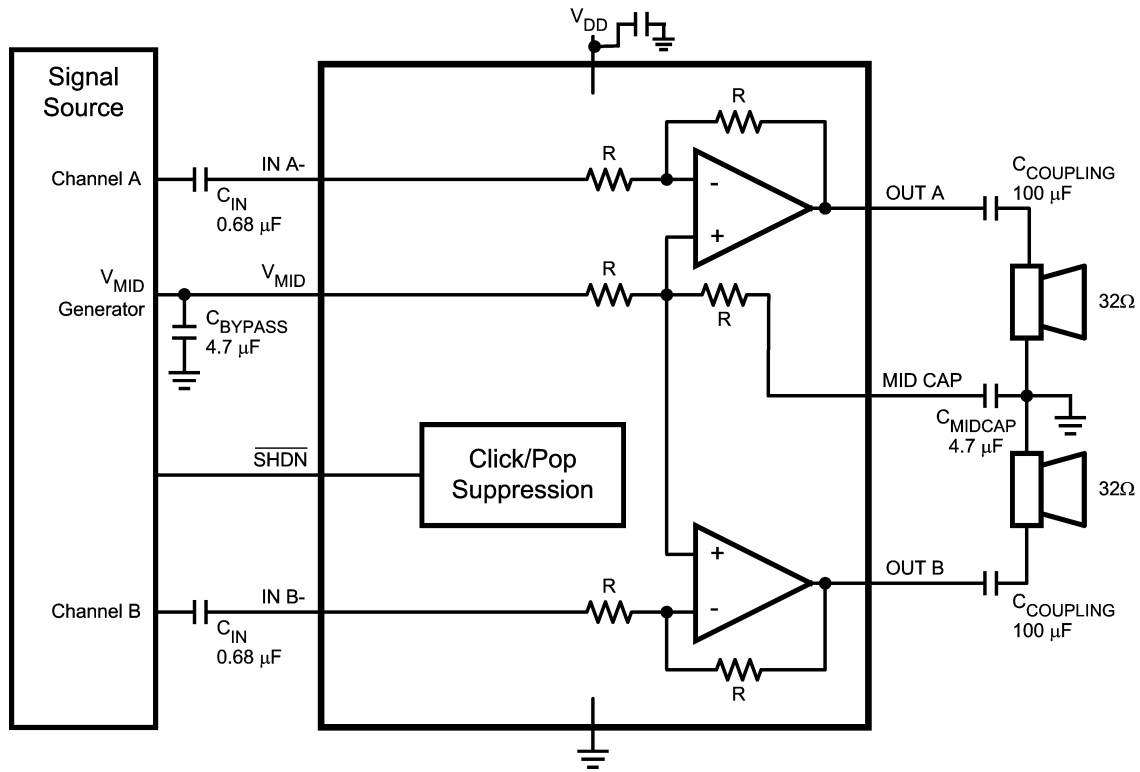

20142903

FIGURE 2. Typical Application Circuit

Absolute Maximum Ratings (Note 1)

If Military/Aerospace specified devices are required, please contact the National Semiconductor Sales Office/Distributors for availability and specifications.

Supply Voltage	3.6V
Storage Temperature	-65°C to +150°C
Input Voltage	-0.3V to $V_{DD} + 0.3V$
Power Dissipation (Note 2)	Internally limited
ESD Susceptibility (Note 3)	2000V
ESD Susceptibility (Note 4)	200V
Junction Temperature	150°C
Solder Information	
Small Outline Package Vapor Phase (60sec)	215°C

Infrared (15 sec)

220°C

See AN-450 "Surface Mounting and their Effects on Product Reliability" for other methods of soldering surface mount devices.

Thermal Resistance

 θ_{JA} (typ) SDA10A

73°C/W

Operating Ratings

Temperature Range

 $T_{MIN} \leq T_A \leq T_{MAX}$ $-40^\circ\text{C} \leq T_A \leq +85^\circ\text{C}$

Supply Voltage

 $1.5V \leq V_{DD} \leq 3.3V$ **Electrical Characteristics $V_{DD} = 3.0V$** (Notes 1, 5)

The following specifications apply for the circuit shown in Figure 2, unless otherwise specified. $A_v = 0\text{dB}$, $R_L = 32\Omega$. Limits apply for $T_A = 25^\circ\text{C}$.

Symbol	Parameter	Conditions	LM4980		Units (Limits)
			Typical (Note 6)	Limit (Note 7)	
I_{DD}	Quiescent Power Supply Current	$V_{IN} = 0V$, $I_O = 0A$, $R_L = \infty$ (Note 8)	1.0	1.5	mA (max)
I_{SD}	Shutdown Current	$V_{SHDN} = GND$	0.1	1	μA (max)
V_{OS}	Output Offset Voltage		1	5	mV
P_O	Output Power (Note 9)	$R_L = 16\Omega$, THD+N = 1%, $f = 1\text{kHz}$, per channel	42	35	mW (min)
		$R_L = 32\Omega$, THD+N = 1%, $f = 1\text{kHz}$, per channel	28		mW (min)
V_{NO}	Output Voltage Noise	20Hz to 20kHz, A-weighted, Fig. 2	10		μV_{RMS}
THD+N	Total Harmonic Distortion + Noise	$R_L = 32\Omega$, $P_{OUT} = 10\text{mW}$, $f = 1\text{kHz}$	0.02		%
Crosstalk		Freq = 1kHz, $P_{OUT} = 28\text{mW}$, $R_L = 32\Omega$	77		dB
PSRR	Power Supply Rejection Ratio	$V_{RIPPLE} = 200\text{mV}_{P-P}$ sine wave $f_{RIPPLE} = 1\text{kHz}$, $C_{MIDCAP} = 4.7\mu\text{F}$, V_{MID} Voltage is Ripple-Free	90		dB
		$V_{RIPPLE} = 200\text{mV}_{P-P}$ sine wave $f_{RIPPLE} = 217\text{Hz}$, $C_{MIDCAP} = 4.7\mu\text{F}$, V_{MID} Voltage is Ripple-Free	100		dB
CMRR	Common-Mode Rejection Ratio	Input coupling capacitors with 5% tolerance, $V_{IN} = V_{MID}$, $f_{RIPPLE} = 1\text{kHz}$	47		dB
$T_{WAKE-UP}$	Wake-up Time	$C_{MIDCAP} = 4.7\mu\text{F}$, Fig 2.	250		ms
V_{IH}	Control Logic High	$1.5V \leq V_{DD} \leq 3.3V$		1.4V	V (min)
V_{IL}	Control Logic Low	$1.5V \leq V_{DD} \leq 3.3V$		0.4V	V (max)

Electrical Characteristics $V_{DD} = 1.8V$ (Notes 1, 5)

The following specifications apply for the circuit shown in Figure 2, unless otherwise specified. $A_v = 0\text{dB}$, $R_L = 32\Omega$. Limits apply for $T_A = 25^\circ\text{C}$.

Symbol	Parameter	Conditions	LM4980		Units (Limits)
			Typical (Note 6)	Limit (Note 7)	
I_{DD}	Quiescent Power Supply Current	$V_{IN} = 0V$, $I_O = 0A$, $R_L = \infty$ (Note 8)	0.9		mA
I_{SD}	Shutdown Current	$V_{SHDN} = GND$	0.1		μA
V_{OS}	Output Offset Voltage		1		mV

Electrical Characteristics $V_{DD} = 1.8V$ (Notes 1, 5) (Continued)

The following specifications apply for the circuit shown in Figure 2, unless otherwise specified. $A_V = 0dB$, $R_L = 32\Omega$. Limits apply for $T_A = 25^\circ C$.

Symbol	Parameter	Conditions	LM4980		Units (Limits)
			Typical (Note 6)	Limit (Note 7)	
P_O	Output Power (Note 9)	$R_L = 16\Omega$, THD+N = 1%, f = 1kHz, per channel	11		mW (min)
		$R_L = 32\Omega$, THD+N = 1%, f = 1kHz, per channel	9		mW (min)
V_{NO}	Output Voltage Noise	20Hz to 20kHz, A-weighted, Fig. 2	9		μV_{RMS}
THD+N	Total Harmonic Distortion + Noise	$R_L = 32\Omega$, $P_{OUT} = 10mW$, f = 1kHz	0.03		%
Crosstalk		Freq = 1kHz, $P_{OUT} = 9mW$, $R_L = 32\Omega$	79		dB
PSRR	Power Supply Rejection Ratio	$V_{RIPPLE} = 200mV_{P-P}$ sine wave $f_{RIPPLE} = 1kHz$, $C_{MIDCAP} = 4.7\mu F$, V_{MID} Voltage is Ripple-Free	78		dB
		$V_{RIPPLE} = 200mV_{P-P}$ sine wave $f_{RIPPLE} = 217Hz$, $C_{MIDCAP} = 4.7\mu F$, V_{MID} Voltage is Ripple-Free	85		dB
CMRR	Common-Mode Rejection Ratio	Input coupling capacitors with 5% tolerance, $V_{IN} = V_{MID}$, $f_{RIPPLE} = 1kHz$	47		dB
$T_{WAKE-UP}$	Wake-up Time	$C_{MIDCAP} = 4.7\mu F$, Fig 2.	320		ms
V_{IH}	Control Logic High	$1.5V \leq V_{DD} \leq 3.3V$		1.4V	V (min)
V_{IL}	Control Logic Low	$1.5V \leq V_{DD} \leq 3.3V$		0.4V	V (max)

Note 1: Absolute Maximum Ratings indicate limits beyond which damage to the device may occur. Operating Ratings indicate conditions for which the device is functional, but do not guarantee specific performance limits. Electrical Characteristics state DC and AC electrical specifications under particular test conditions which guarantee specific performance limits. This assumes that the device is within the Operating Ratings. Specifications are not guaranteed for parameters where no limit is given, however, the typical value is a good indication of device performance.

Note 2: The maximum power dissipation is dictated by T_{JMAX} , θ_{JA} , and the ambient temperature T_A must be derated at elevated temperatures. The maximum allowable power dissipation is $P_{DMAX} = (T_{JMAX} - T_A) / \theta_{JA}$. For the LM4980, $T_{JMAX} = 150^\circ C$. For the θ_{JA} s, please see the Application Information section or the Absolute Maximum Ratings section.

Note 3: Human body model, 100pF discharged through a 1.5k Ω resistor.

Note 4: Machine model, 200pF – 220pF discharged through all pins.

Note 5: All voltages are measured with respect to the ground (GND) pins unless otherwise specified.

Note 6: Typical values are measured at 25°C and represent the parametric norm.

Note 7: Datasheet min/max specification limits are guaranteed by design, test, or statistical analysis.

Note 8: The quiescent power supply current depends on the offset voltage when a practical load is connected to the amplifier.

Note 9: Output power is measured at the device terminals.

Typical Performance Characteristics (T_A = 25°C)

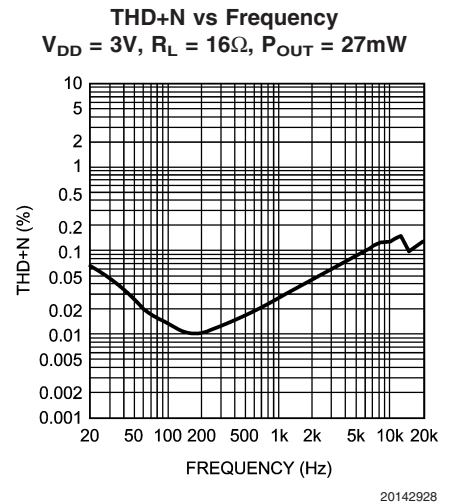
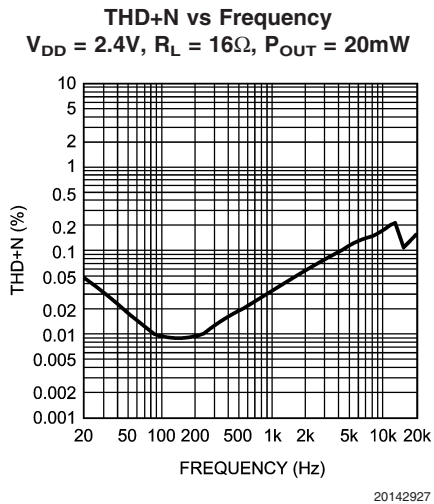
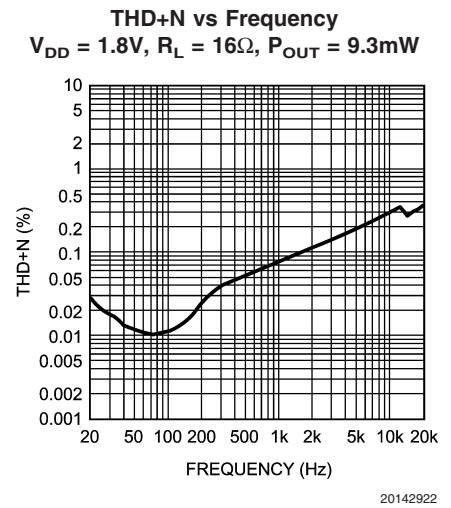
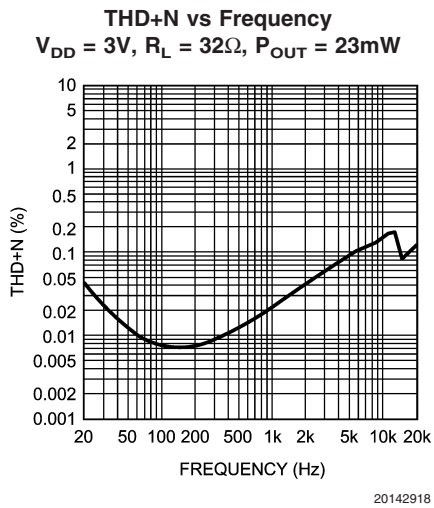
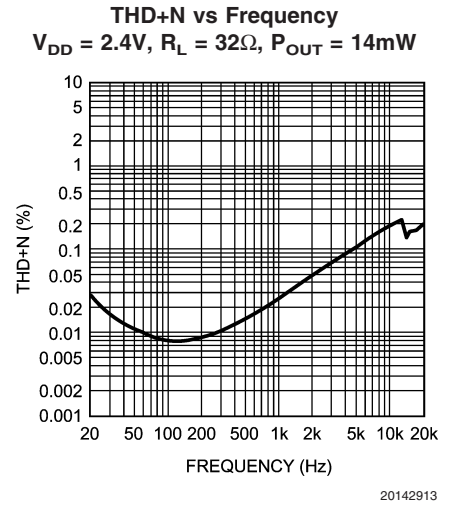
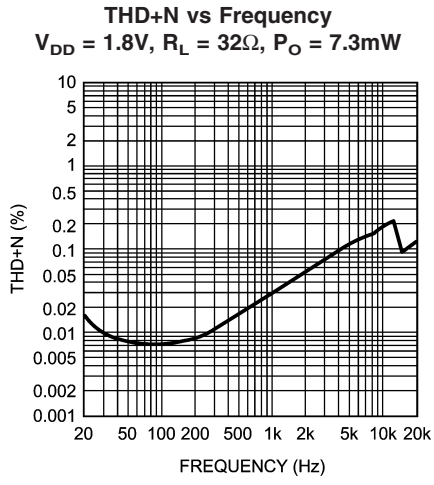

Typical Performance Characteristics ($T_A = 25^\circ\text{C}$) (Continued)

THD+N vs Output Power
 $V_{DD} = 1.8\text{V}, R_L = 32\Omega$

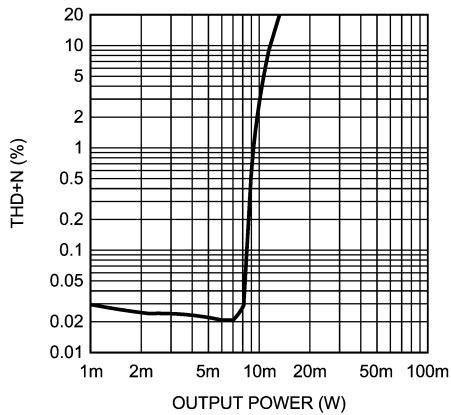

20142935

THD+N vs Output Power
 $V_{DD} = 2.4\text{V}, R_L = 32\Omega$

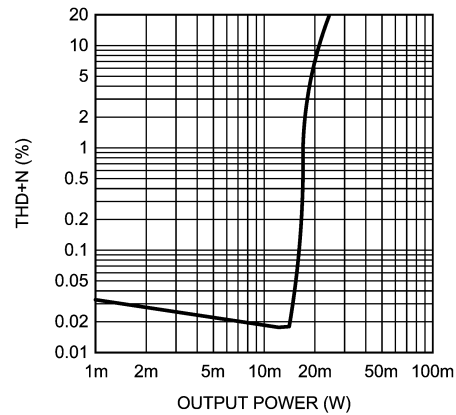

20142936

THD+N vs Output Power
 $V_{DD} = 3\text{V}, R_L = 32\Omega$

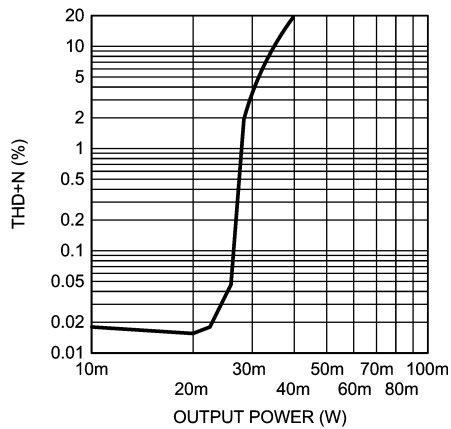

20142937

THD+N vs Output Power
 $V_{DD} = 1.8\text{V}, R_L = 16\Omega$

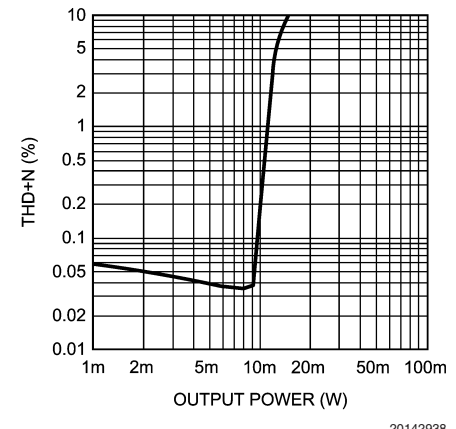

20142938

THD+N vs Output Power
 $V_{DD} = 2.4\text{V}, R_L = 16\Omega$

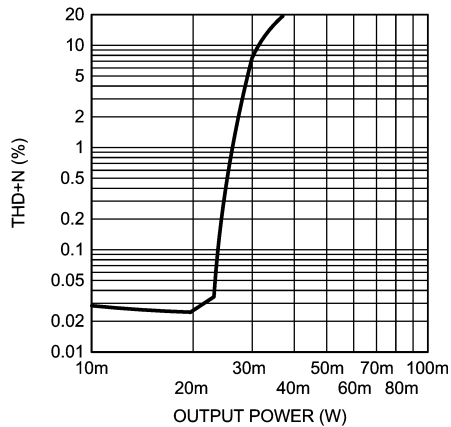

20142939

THD+N vs Output Power
 $V_{DD} = 3\text{V}, R_L = 16\Omega$

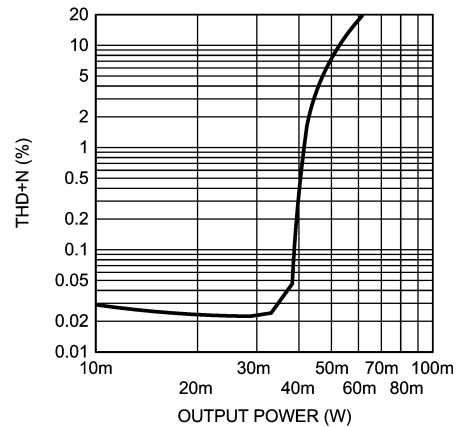

20142940

Typical Performance Characteristics ($T_A = 25^\circ\text{C}$) (Continued)

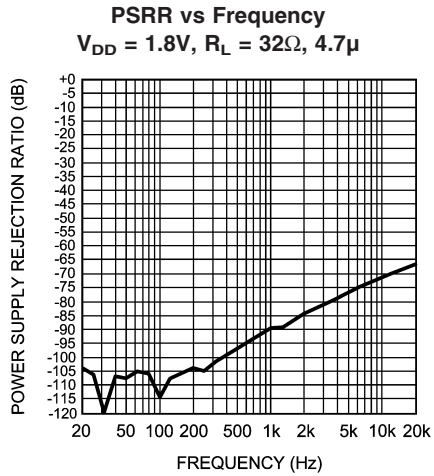

20142941

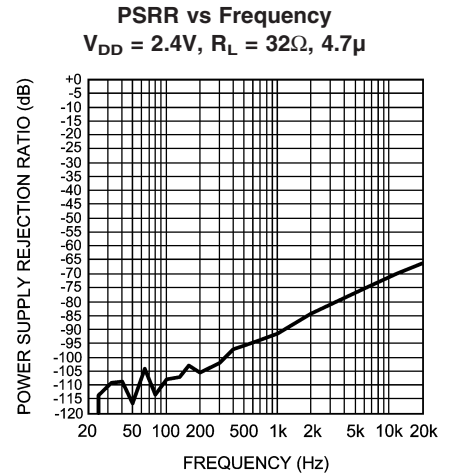

20142942

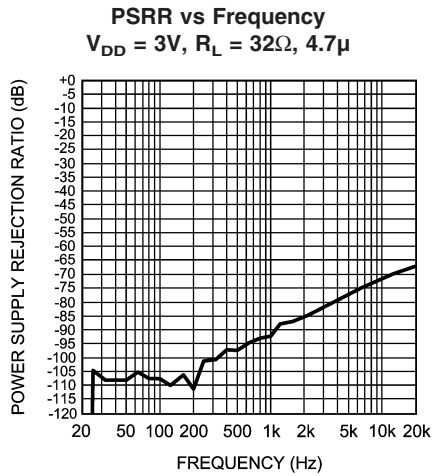

20142943

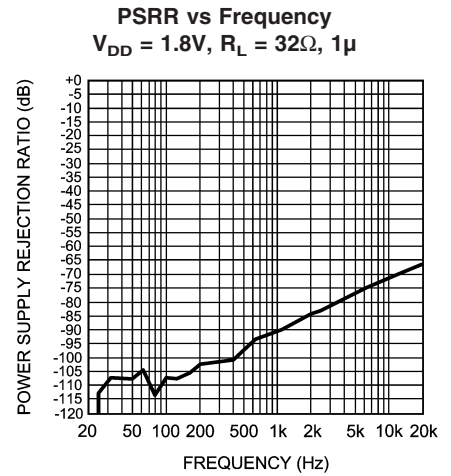

20142944

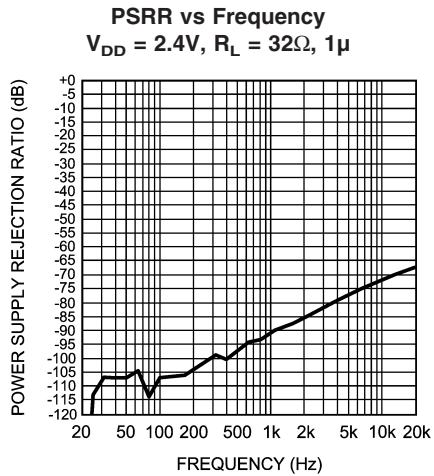

20142945

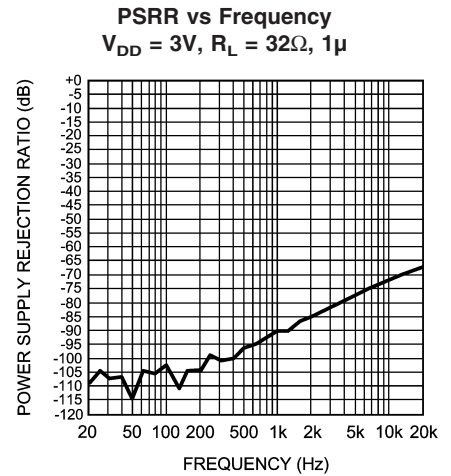

20142946

Typical Performance Characteristics ($T_A = 25^\circ\text{C}$) (Continued)

Crosstalk vs Frequency
 $V_{DD} = 1.8\text{V}$, $R_L = 32\Omega$, $P_{OUT} = 9\text{mW}$
 Channel A Driven, Channel B Measured

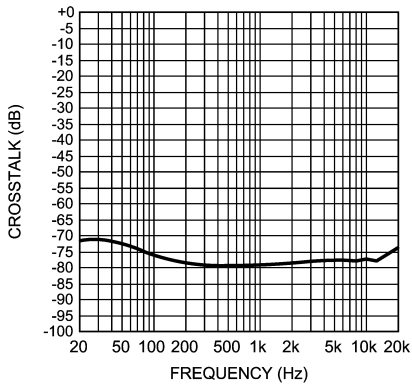

20142947

Crosstalk vs Frequency
 $V_{DD} = 1.8\text{V}$, $R_L = 32\Omega$, $P_{OUT} = 9\text{mW}$
 Channel B Driven, Channel A Measured

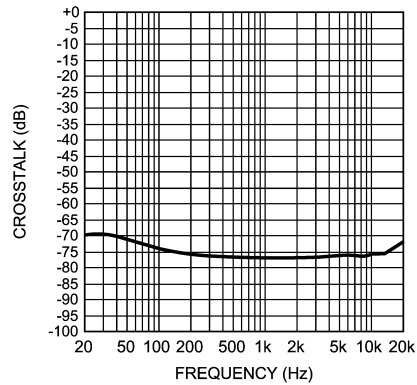

20142948

Crosstalk vs Frequency
 $V_{DD} = 2.4\text{V}$, $R_L = 32\Omega$, $P_{OUT} = 17\text{mW}$
 Channel A Driven, Channel B Measured

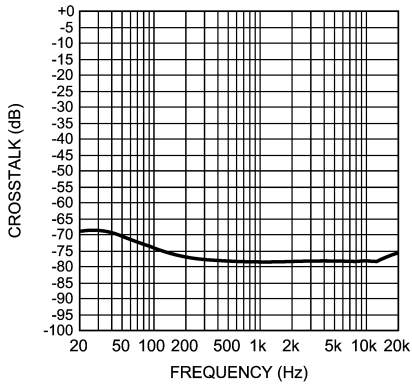

20142950

Crosstalk vs Frequency
 $V_{DD} = 2.4\text{V}$, $R_L = 32\Omega$, $P_{OUT} = 17\text{mW}$
 Channel B Driven, Channel A Measured

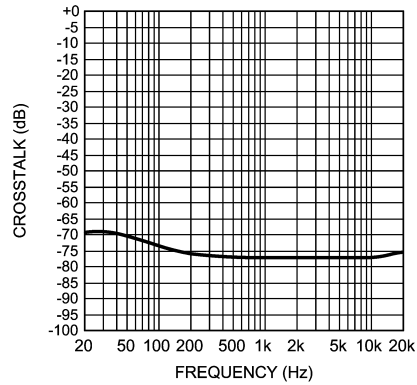

20142949

Crosstalk vs Frequency
 $V_{DD} = 3\text{V}$, $R_L = 32\Omega$, $P_{OUT} = 27\text{mW}$
 Channel A Driven, Channel B Measured

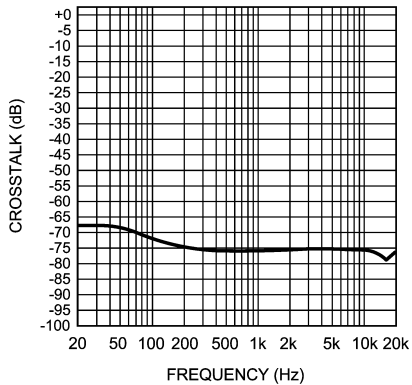

20142951

Crosstalk vs Frequency
 $V_{DD} = 3\text{V}$, $R_L = 32\Omega$, $P_{OUT} = 27\text{mW}$
 Channel B Driven, Channel A Measured

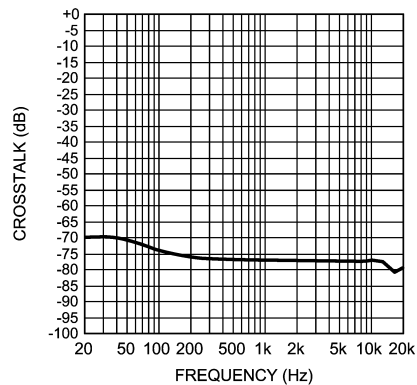

20142953

Typical Performance Characteristics ($T_A = 25^\circ\text{C}$) (Continued)

Crosstalk vs Frequency
 $V_{DD} = 1.8\text{V}$, $R_L = 16\Omega$, $P_{OUT} = 11\text{mW}$
 Channel A Driven, Channel B Measured

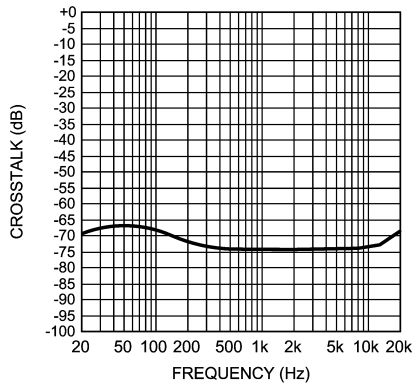

20142954

Crosstalk vs Frequency
 $V_{DD} = 1.8\text{V}$, $R_L = 16\Omega$, $P_{OUT} = 11\text{mW}$
 Channel B Driven, Channel A Measured

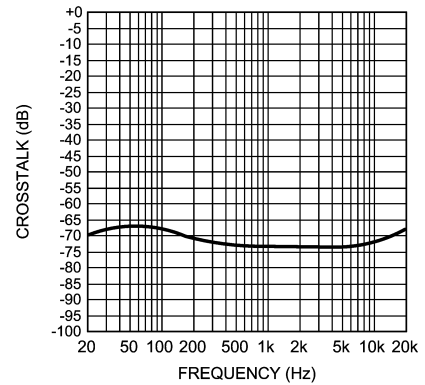

20142956

Crosstalk vs Frequency
 $V_{DD} = 2.4\text{V}$, $R_L = 16\Omega$, $P_{OUT} = 24\text{mW}$
 Channel A Driven, Channel B Measured

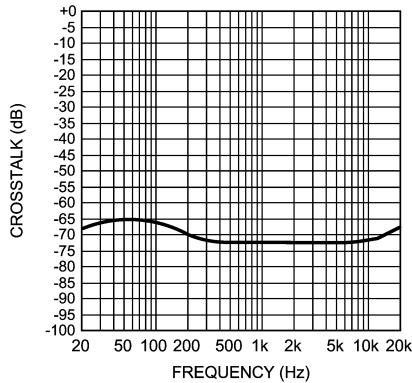

20142960

Crosstalk vs Frequency
 $V_{DD} = 2.4\text{V}$, $R_L = 16\Omega$, $P_{OUT} = 24\text{mW}$
 Channel B Driven, Channel A Measured

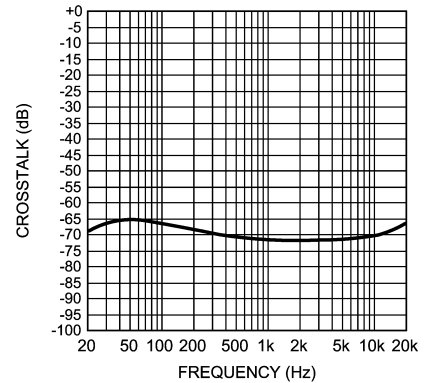

20142968

Crosstalk vs Frequency
 $V_{DD} = 3\text{V}$, $R_L = 16\Omega$, $P_{OUT} = 42\text{mW}$
 Channel A Driven, Channel B Measured

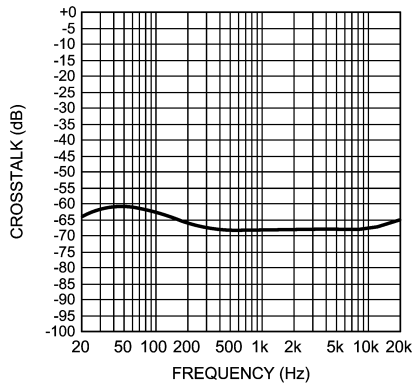

20142969

Crosstalk vs Frequency
 $V_{DD} = 3\text{V}$, $R_L = 16\Omega$, $P_{OUT} = 42\text{mW}$
 Channel B Driven, Channel A Measured

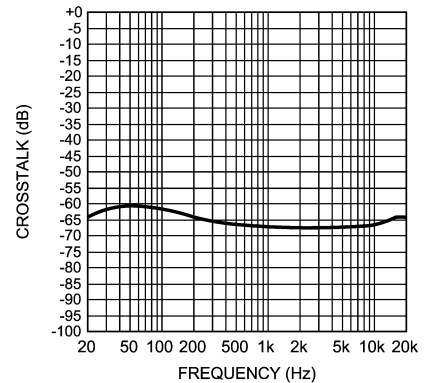

20142970

Typical Performance Characteristics ($T_A = 25^\circ\text{C}$) (Continued)

Output Power vs Supply Voltage
 $R_L = 32\Omega$

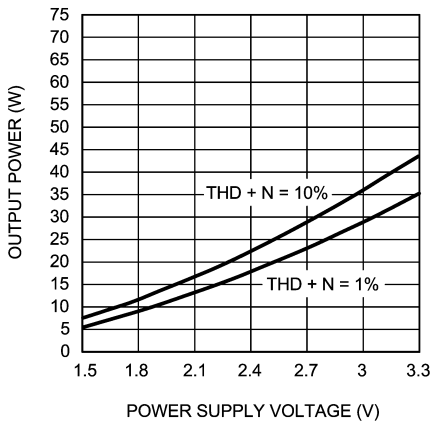

20142990

Output Power vs Supply Voltage
 $R_L = 16\Omega$

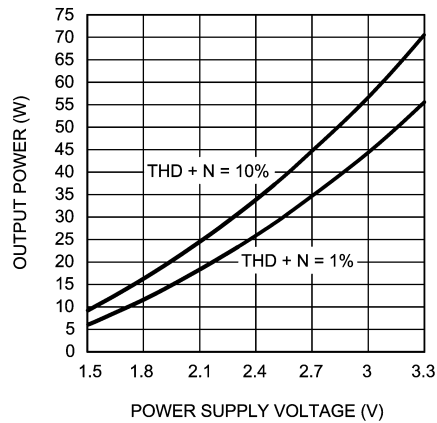

20142991

Output Power vs Load Resistance
 $V_{DD} = 1.8\text{V}$

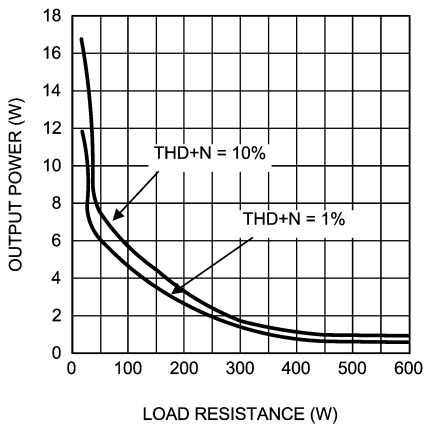

20142973

Output Power vs Load Resistance
 $V_{DD} = 2.4\text{V}$

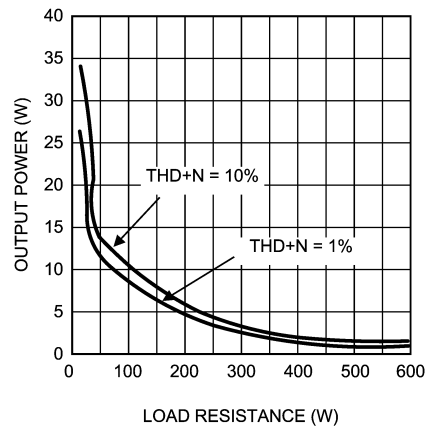

20142974

Output Power vs Load Resistance
 $V_{DD} = 3.0\text{V}$

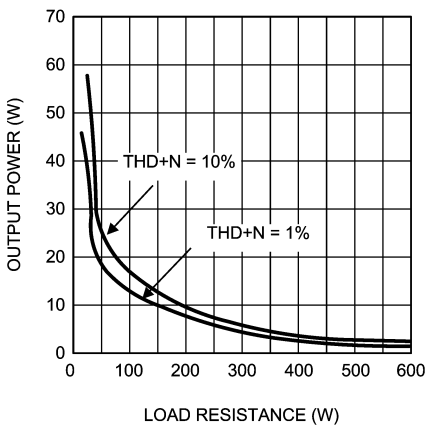

20142975

Load Dissipation vs Amplifier Dissipation
 $V_{DD} = 1.8\text{V}$

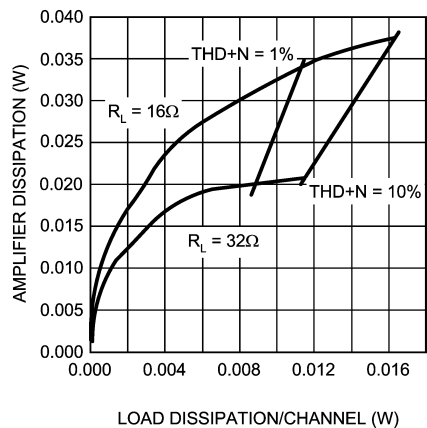

20142976

Typical Performance Characteristics ($T_A = 25^\circ\text{C}$) (Continued)

Amplifier Dissipation vs Load Dissipation
 $V_{DD} = 2.4\text{V}$

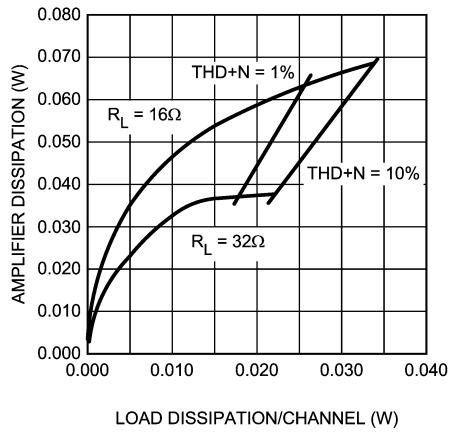

Amplifier Dissipation vs Load Dissipation
 $V_{DD} = 3.0\text{V}$

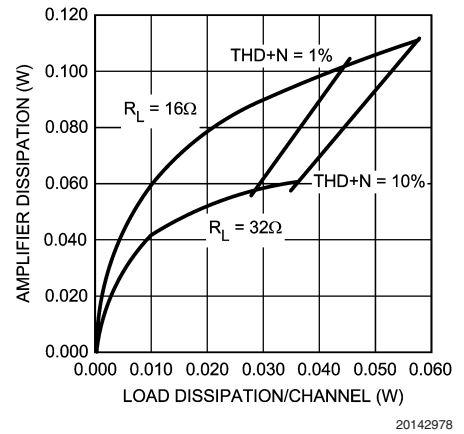

Power Supply Current vs Power Supply Voltage
 $V_{IN} = 0\text{V}$

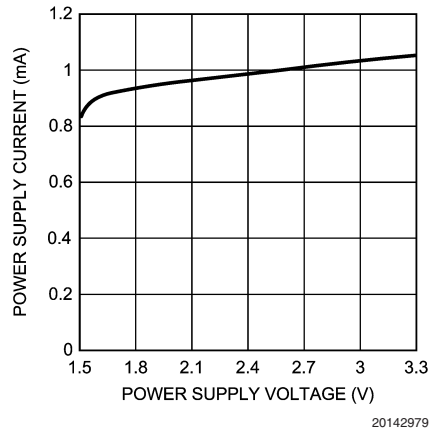

Application Information

AMPLIFIER CONFIGURATION

As shown in Figure 1, the LM4980 consists of a stereo pair of audio amplifiers. These amplifiers operate on a single supply and have single-ended inputs and outputs. The quiescent operating point of each amplifier input and output is equal to the voltage applied to the V_{MID} pin (usually $V_{DD}/2$).

C_{MIDCAP} VALUE SELECTION

Careful consideration should be paid to value of C_{MIDCAP} , the capacitor connected between the MIDCAP pin and ground. The value of C_{MIDCAP} determines how fast the LM4980 settles to quiescent operation and determines the amount of output transient suppression. Choosing C_{MIDCAP} equal to 4.7 μ F along with a small value of C_{IN} (in the range of 0.1 μ F to 1.0 μ F), produces shutdown function that is essentially output-transient free. Choosing C_{IN} no larger than necessary for the desired bandwidth helps minimize clicks and pops. This ensures that output transients are minimized when power is first applied or the LM4980 resumes operation after shutdown. The MIDCAP offers the following benefits: better linearity for reduced THD+N, reduced channel-to-channel crosstalk, and less susceptibility to ground noise. For the ultimate suppression of output transient when power is applied or removed, ensure that the voltage applied to the SHDN pin is a logic low. This will activate the micro-power shutdown.

OPTIMIZING OUTPUT-GROUND NOISE REDUCTION

In addition to the output-ground noise reduction afforded by C_{MIDCAP} , further reduction can be achieved by the inclusion of a ferrite bead. The ferrite bead (FB) is placed between ground and common connection between the C_{MIDCAP} and the headphone ground connection. This is shown in Figure 3. The ferrite bead is beneficial in environments where the headphone and C_{MIDCAP} ground connection is shared with circuitry (such as video) that may inject noise on a common ground.

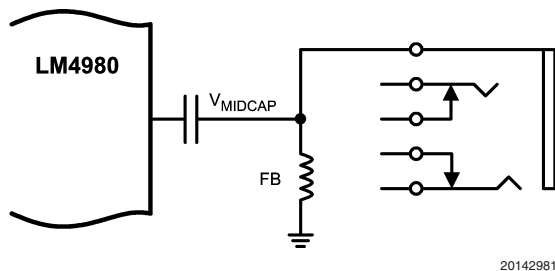

FIGURE 3. Adding a ferrite bead improves ground-noise suppression

OPTIMIZING OUTPUT TRANSIENT SUPPRESSION

The LM4980 contains circuitry that eliminates turn-on and shutdown output transients ("clicks and pops"). For this discussion, turn-on refers to either applying the power supply voltage or when the micro-power shutdown mode is deactivated. The turn-on time delay is the time duration that occurs between the application of the power supply voltage or deactivating shutdown and when the applied input signal appears at the amplifier outputs.

C_{MIDCAP} 's value plays a significant role in the suppression of output transients. The amount of suppression increases as

C_{MIDCAP} 's value increases. However, changing the value of C_{MIDCAP} alters the LM4980's turn-on time. There is a linear relationship between the value of C_{MIDCAP} and the turn-on time. Here are some typical turn-on times for various values of C_{MIDCAP} .

TABLE 1. Typical turn-on time versus C_{MIDCAP} value

C_{MIDCAP} VALUE (μ F)	Turn-On Time (ms)
4.7	250
6.8	360
10.0	530

STAND-ALONE V_{MID} VOLTAGE GENERATION

The LM4980 is designed to take advantage of audio DACs (digital-to-analog converters) and other signal sources that, in addition to generating an analog signal, also create an AC ground potential. This AC ground potential is typically $V_{DD}/2$. This $V_{DD}/2$ is applied to the LM4980's V_{MID} pin (pin 4).

Using two external resistors allows the LM4980 to be easily used in applications where the V_{MID} voltage is not internally generated and supplied to the LM4980 by other circuits. Figure 4 shows this configuration.

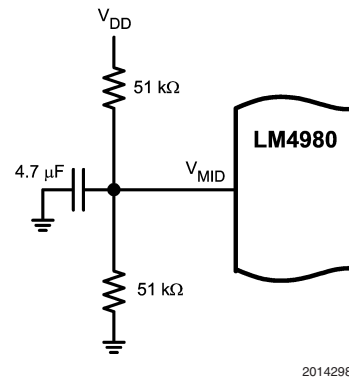

FIGURE 4. Simple circuit generates LM4980's V_{MID} voltage

SELECTING THE OUTPUT COUPLING CAPACITOR VALUE

To ensure that no performance degrading DC current flows through the load (something with which speakers would just as soon not have to tolerate), coupling capacitors are necessary between the amplifier output pins and the load. Besides blocking DC current, the output coupling capacitor value, together with the load resistance, produces a low frequency amplitude rolloff, whose cutoff frequency is found using Equation 1.

$$f_{-3\text{dB}} = \frac{1}{2\pi R_{\text{LOAD}} C_{\text{COUPLING}}} \quad (1)$$

When driving 32 Ω headphones, the 220 μ F C_{COUPLING} capacitors shown in Figure 2 produce a cutoff frequency equal to 23Hz.

The output coupling capacitors also influence the output transient behavior at power-up and when activating or deac-

Application Information (Continued)

tivating shutdown. As C_{COUPLING} 's value increases, output transient magnitude can also increase. This increase can be mitigated by a corresponding increase in C_{MIDCAP} 's value. A minimum starting point when selecting C_{MIDCAP} 's value is $6.8\mu\text{F}$ when using $220\mu\text{F}$ output coupling capacitors.

SELECTING THE INPUT CAPACITOR VALUE

Amplifying the lowest audio frequencies requires a relatively high value input coupling capacitor, (C_{IN} in Figure 2). A high value capacitor can be expensive and may compromise space efficiency in portable designs. In many cases, however, the headphones used in portable systems have limited ability to reproduce signals below 60Hz. Applications using headphones with this limited frequency response reap little improvement by using a high value input capacitor. A small value of C_{I} (in the range of $0.1\mu\text{F}$ to $1.0\mu\text{F}$), is recommended.

DRIVING POWERED SPEAKERS

Though the LM4980 is design primarily to drive headphones, in many cases, it may be called on to act as a line level driver when powered speakers or other devices may be connected to the amplifier outputs. For powered speakers or other devices with typical input resistances ($10\text{k}\Omega$) that are significantly higher than the typical headphone resistance (32Ω), the output transients may not sufficiently suppressed when using the Figure 2 circuit. If this is anticipated, a minor modification of an additional resistor (a nominal value of $1\text{k}\Omega$) between each output and ground in the Figure 2 circuit is needed to ensure that the output transient suppression is not compromised. This reduces both the load resistance seen by the LM4980 and the magnitude of power-on and shutdown output transients.

POWER DISSIPATION

Power dissipation has to be evaluated and considered when designing a successful amplifier. A direct consequence of the power delivered to a load an amplifier is internal power dissipation. The maximum per-amplifier power dissipation for a given application can be derived from the power dissipation graphs or from Equation 2.

$$P_{\text{DMAX}} = V_{\text{DD}}^2 / 2\pi R_{\text{LOAD}} \quad (2)$$

It is critical that the maximum junction temperature T_{JMAX} of 150°C is not exceeded. Since the typical application is for headphone operation (16Ω impedance) using a 3.0V supply the maximum power dissipation is less than 29mW . Therefore, in the case of this headphone amplifier, the power dissipation is not a major concern.

POWER SUPPLY BYPASSING

As with any amplifier, proper supply bypassing is important for low noise performance and high power supply rejection. The capacitor location on the power supply pins should be as close to the device as possible. Typical applications employ a 3.0V regulator with $10\mu\text{F}$ tantalum or electrolytic capacitor and a ceramic bypass capacitor which aid in supply stability. This does not eliminate the need for local power supply bypassing connected as close as possible to the LM4980's supply pin. A power supply bypass capacitor value in the range of $1.0\mu\text{F}$ to $10\mu\text{F}$ is recommended.

MICRO POWER SHUTDOWN

The voltage applied to the shutdown ($\overline{\text{SHDN}}$) pin controls the LM4980's shutdown function. Activate micro-power shutdown by applying a logic-low voltage to the $\overline{\text{SHDN}}$ pin. When active, the LM4980's micro-power shutdown feature turns off the amplifier's bias circuitry, reducing the supply current. The trigger point is 0.4V (max) for a logic-low level, and 1.4V (min) for a logic-high level. The low $0.1\mu\text{A}$ (typ) shutdown current is achieved by applying a voltage that is as near as ground as possible to the $\overline{\text{SHDN}}$ pin. A voltage that is higher than ground may increase the shutdown current.

There are a few ways to control the micro-power shutdown. These include using a single-pole, single-throw switch, a microprocessor, or a microcontroller. When using a switch, connect an external $100\text{k}\Omega$ pull-up resistor between the $\overline{\text{SHDN}}$ pin and GND. Connect the switch between the $\overline{\text{SHDN}}$ pin and V_{DD} . Select normal amplifier operation by closing the switch. Opening the switch connects the $\overline{\text{SHDN}}$ pin to ground, activating micro-power shutdown. The switch and resistor guarantee that the $\overline{\text{SHDN}}$ pin will not float. This prevents unwanted state changes. In a system with a microprocessor or microcontroller, use a digital output to apply the control voltage to the $\overline{\text{SHDN}}$ pin. Driving the $\overline{\text{SHDN}}$ pin with active circuitry eliminates the pull-up resistor.

SUGGESTED PCB SCHEMATIC

Figure 5 is the schematic for the suggested PCB Layout. This schematic and its associated PCB provide both a lean tested layout and platform that can be used to verify the LM4980's outstanding audio performance.

Suggested PCB Design and Layout

Figures 6 through 9 show a suggested PCB layout for a headphone amplifier circuit using the LM4980 .

PCB Layout Guidelines

This section provides practical guidelines for mixed signal PCB layout that involves various digital/analog power and ground traces. Designers should note that these are only "rule-of-thumb" recommendations and the actual results will depend heavily on the final layout.

MINIMIZING THD+N

PCB trace impedance on the power, ground, and all output traces should be minimized to achieve optimal THD performance. Therefore, use PCB traces that are as wide as possible for these connections. As the gain of the amplifier is increased, the trace impedance will have an ever increasing adverse affect on THD performance. At unity-gain (0dB) the parasitic trace impedance effect on THD performance is reduced but still a negative factor in the THD performance of the LM4980 in a given application.

GENERAL MIXED SIGNAL LAYOUT RECOMMENDATION

Power and Ground Circuits

For two layer mixed signal design, it is important to isolate the digital power and ground trace paths from the analog power and ground trace paths. Star trace routing techniques (bringing individual traces back to a central point rather than daisy chaining traces together in a serial manner) can greatly enhance low level signal performance. Star trace

Application Information (Continued)

routing refers to using individual traces to feed power and ground to each circuit or even device. This technique will require a greater amount of design time but will not increase the final price of the board. The only extra parts required may be some jumpers.

Single-Point Power and Ground Connections

The analog power traces should be connected to the digital traces through a single point (link). A "PI-filter" can be helpful in minimizing high frequency noise coupling between the analog and digital sections. Further, place digital and analog power traces over the corresponding digital and analog ground traces to minimize noise coupling.

Placement of Digital and Analog Components

All digital components and high-speed digital signal traces should be located as far away as possible from analog components and circuit traces.

Avoiding Typical Design / Layout Problems

Avoid ground loops or running digital and analog traces parallel to each other (side-by-side) on the same PCB layer. When traces must cross over each other do it at 90 degrees. Running digital and analog traces at 90 degrees to each other from the top to the bottom side as much as possible will minimize capacitive noise coupling and cross talk.

Schematic for the LM4980 Suggested PCB Layout

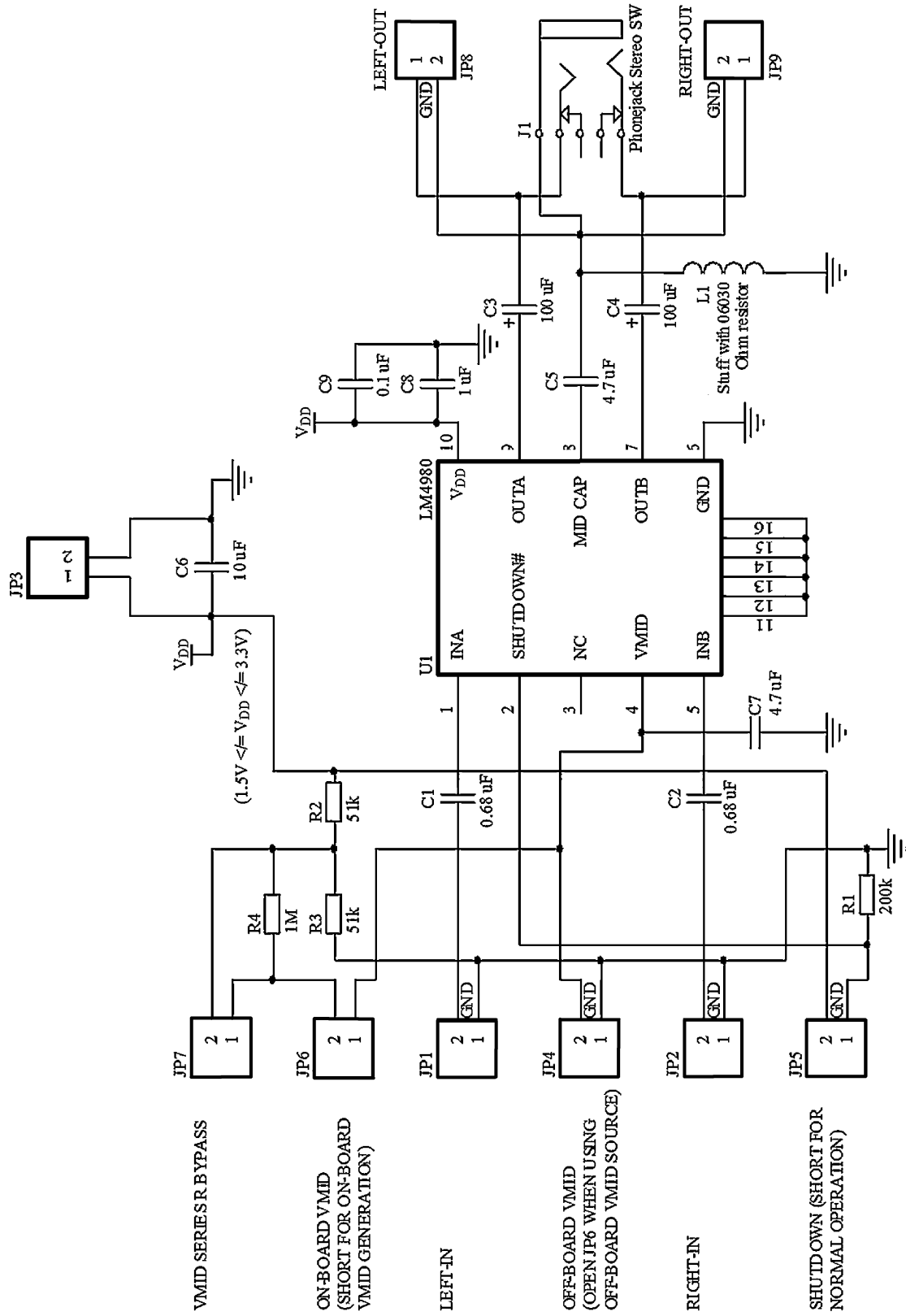

FIGURE 5.

Suggested PCB Layout

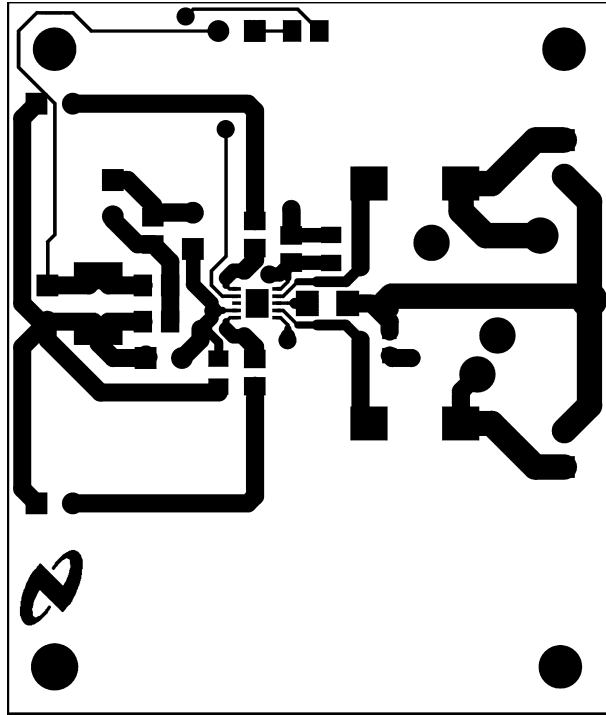

FIGURE 6. Top Layer

20142982

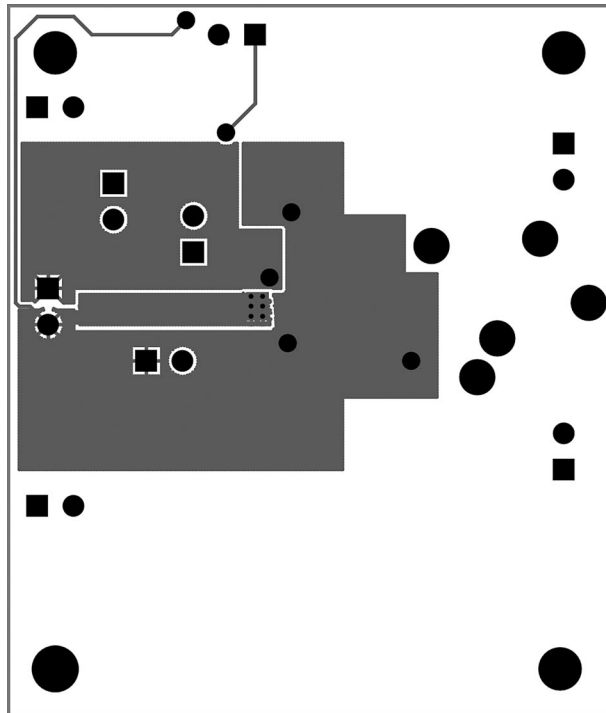
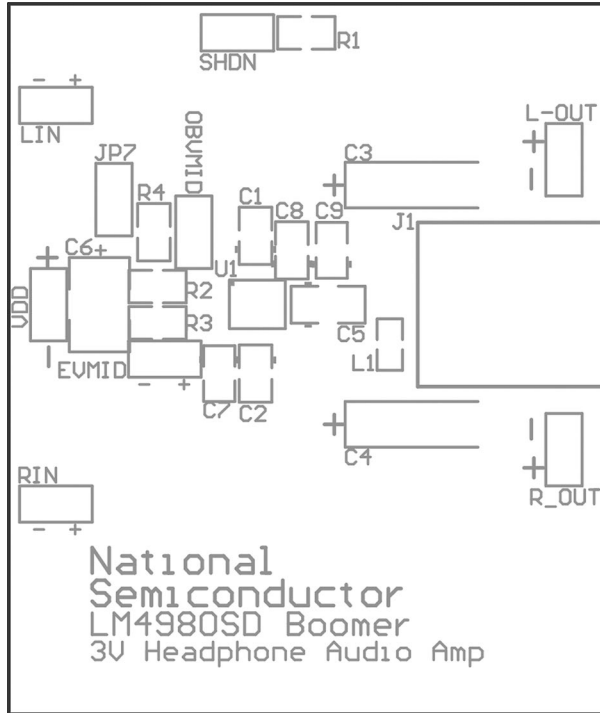

FIGURE 7. Bottom Layer

20142983

Suggested PCB Layout (Continued)



20142984

FIGURE 8. Silkscreen Layer

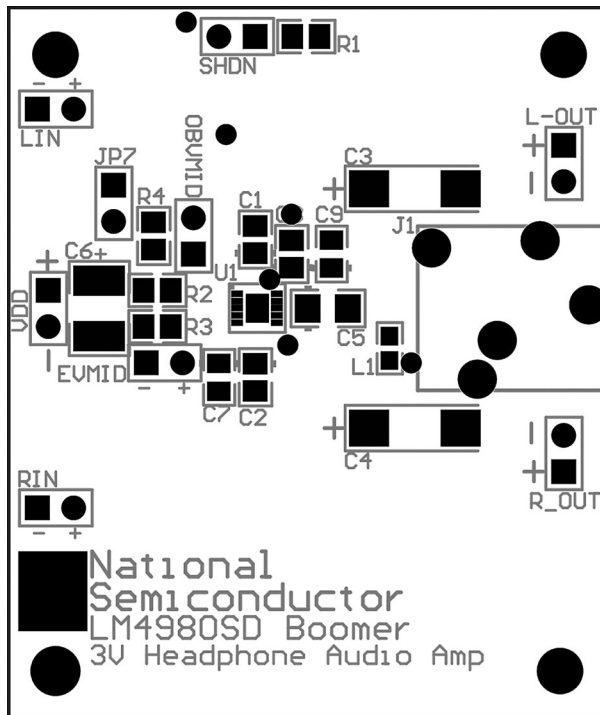

20142988

FIGURE 9. Top Layer Pads

Revision History

Rev	Date	Description
1.0	6/08/05	Initial release.
1.1	6/29/05	Correct typographical and schematic errors. Re-released D/S to the WEB.
1.2	7/18/05	Replaced curves 20142971 and 72 with 20142990 and 91 respectively, then re-released D/S to the WEB.

Physical Dimensions inches (millimeters) unless otherwise noted

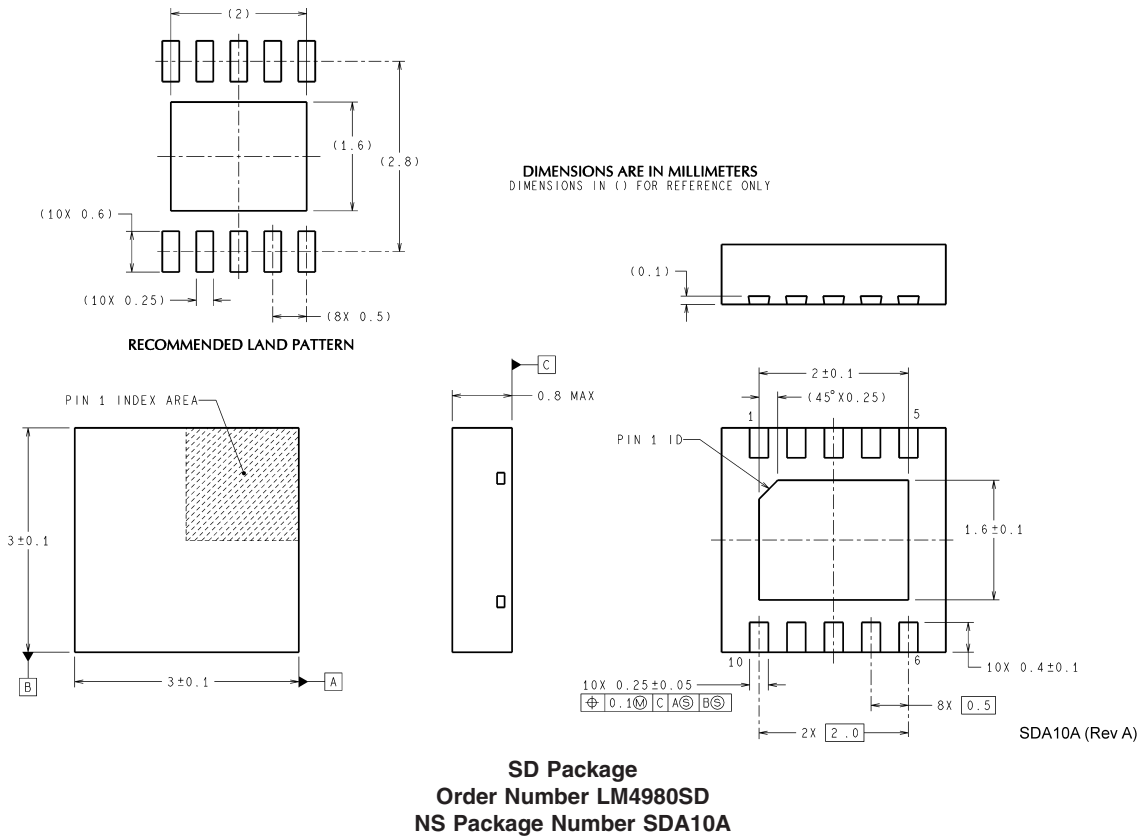

National does not assume any responsibility for use of any circuitry described, no circuit patent licenses are implied and National reserves the right at any time without notice to change said circuitry and specifications.

For the most current product information visit us at www.national.com.

LIFE SUPPORT POLICY

NATIONAL'S PRODUCTS ARE NOT AUTHORIZED FOR USE AS CRITICAL COMPONENTS IN LIFE SUPPORT DEVICES OR SYSTEMS WITHOUT THE EXPRESS WRITTEN APPROVAL OF THE PRESIDENT AND GENERAL COUNSEL OF NATIONAL SEMICONDUCTOR CORPORATION. As used herein:

1. Life support devices or systems are devices or systems which, (a) are intended for surgical implant into the body, or (b) support or sustain life, and whose failure to perform when properly used in accordance with instructions for use provided in the labeling, can be reasonably expected to result in a significant injury to the user.
2. A critical component is any component of a life support device or system whose failure to perform can be reasonably expected to cause the failure of the life support device or system, or to affect its safety or effectiveness.

BANNED SUBSTANCE COMPLIANCE

National Semiconductor manufactures products and uses packing materials that meet the provisions of the Customer Products Stewardship Specification (CSP-9-111C2) and the Banned Substances and Materials of Interest Specification (CSP-9-111S2) and contain no "Banned Substances" as defined in CSP-9-111S2.

Leadfree products are RoHS compliant.

National Semiconductor
Americas Customer Support Center
 Email: new.feedback@nsc.com
 Tel: 1-800-272-9959

National Semiconductor
Europe Customer Support Center
 Fax: +49 (0) 180-530 85 86
 Email: europe.support@nsc.com
 Deutsch Tel: +49 (0) 69 9508 6208
 English Tel: +44 (0) 870 24 0 2171
 Français Tel: +33 (0) 1 41 91 8790

National Semiconductor
Asia Pacific Customer Support Center
 Email: ap.support@nsc.com

National Semiconductor
Japan Customer Support Center
 Fax: 81-3-5639-7507
 Email: jpn.feedback@nsc.com
 Tel: 81-3-5639-7560