



May 2016

FODM3062, FODM3063, FODM3082, FODM3083 4-Pin Full Pitch Mini-Flat Package Zero-Cross Triac Driver Output Optocouplers

Features

- Critical Rate of Rise of Off-Stage Voltage
- dv/dt of 600 V/ μ s Guaranteed
- Zero Voltage Crossing
- Peak Blocking Voltage
- 600 V (FODM306X)
- 800 V (FODM308X)
- Compact 4-Pin Surface Mount Package
- 2.4 mm Maximum Standoff Height
- Safety Regulatory Approvals:
- UL1577, 3,750 VAC_{RMS} for 1 Minute
- DIN-EN/IEC60747-5-5, 565 V Peak Working
Insulation Voltage

Applications

- Solenoid/valve controls
- Lighting controls
- Static power switches
- AC motor drives
- Temperature controls
- E.M. contactors
- AC motor starters
- Solid state relays

Description

The FODM306X and FODM308X series consist of an infrared emitting diode optically coupled to a monolithic silicon detector performing the function of a zero voltage crossing bilateral triac driver, and is housed in a compact 4-pin mini-flat package. The lead pitch is 2.54 mm. They are designed for use with a triac in the interface of logic systems to equipment powered from 115/240 VAC lines, such as solid state relays, industrial controls, motors, solenoids and consumer appliances.

Functional Schematic

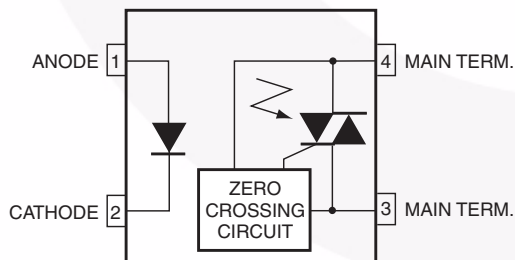

Figure 1. Functional Schematic

Package Outlines

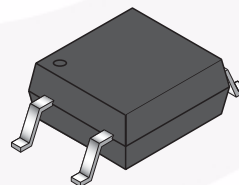

Figure 2. Package Outline

Safety and Insulation Ratings

As per DIN EN/IEC 60747-5-5, this optocoupler is suitable for “safe electrical insulation” only within the safety limit data. Compliance with the safety ratings shall be ensured by means of protective circuits.

Parameter		Characteristics
Installation Classifications per DIN VDE 0110/1.89 Table 1, For Rated Mains Voltage	< 150 V _{RMS}	I–IV
	< 300 V _{RMS}	I–III
Climatic Classification		40/100/21
Pollution Degree (DIN VDE 0110/1.89)		2
Comparative Tracking Index		175

Symbol	Parameter	Value	Unit
V _{PR}	Input-to-Output Test Voltage, Method A, V _{IORM} × 1.6 = V _{PR} , Type and Sample Test with t _m = 10 s, Partial Discharge < 5 pC	904	V _{peak}
	Input-to-Output Test Voltage, Method B, V _{IORM} × 1.875 = V _{PR} , 100% Production Test with t _m = 1 s, Partial Discharge < 5 pC	1060	V _{peak}
V _{IORM}	Maximum Working Insulation Voltage	565	V _{peak}
V _{IOTM}	Highest Allowable Over-Voltage	6000	V _{peak}
	External Creepage	≥ 5	mm
	External Clearance	≥ 5	mm
DTI	Distance Through Insulation (Insulation Thickness)	≥ 0.4	mm
T _S	Case Temperature ⁽¹⁾	150	°C
I _{S,INPUT}	Input Current ⁽¹⁾	200	mA
P _{S,OUTPUT}	Output Power ⁽¹⁾	300	mW
R _{IO}	Insulation Resistance at T _S , V _{IO} = 500 V ⁽¹⁾	> 10 ⁹	Ω

Note:

1. Safety limit values – maximum values allowed in the event of a failure.

Absolute Maximum Ratings

Stresses exceeding the absolute maximum ratings may damage the device. The device may not function or be operable above the recommended operating conditions and stressing the parts to these levels is not recommended. In addition, extended exposure to stresses above the recommended operating conditions may affect device reliability. The absolute maximum ratings are stress ratings only. $T_A = 25^\circ\text{C}$ unless otherwise specified.

Symbol	Parameter	Value	Unit	
T_{STG}	Storage Temperature	-55 to +150	$^\circ\text{C}$	
T_{OPR}	Operating Temperature	-40 to +100	$^\circ\text{C}$	
T_J	Junction Temperature	-40 to +125	$^\circ\text{C}$	
T_{SOL}	Lead Solder Temperature	260 for 10 sec	$^\circ\text{C}$	
EMITTER				
I_F (avg)	Continuous Forward Current	60	mA	
I_F (pk)	Peak Forward Current (1 μs pulse, 300 pps.)	1	A	
V_R	Reverse Input Voltage	6	V	
$P_{D(EMITTER)}$	Power Dissipation (No derating required over operating temp. range)	100	mW	
DETECTOR				
$I_{T(RMS)}$	On-State RMS Current	70	mA	
V_{DRM}	Off-State Output Terminal Voltage	FODM3062/FODM3063	600	V
		FODM3082/FODM3083	800	V
$P_{D(DETECTOR)}$	Power Dissipation (No derating required over operating temp. range)	300	mW	

Electrical Characteristics

$T_A = 25^\circ\text{C}$ unless otherwise specified.

Individual Component Characteristics

Symbol	Parameter	Test Conditions	Device	Min.	Typ.	Max.	Unit
EMITTER							
V_F	Input Forward Voltage	$I_F = 30\text{ mA}$	All			1.50	V
I_R	Reverse Leakage Current	$V_R = 6\text{ V}$	All			100	μA
DETECTOR							
I_{DRM}	Peak Blocking Current Either Direction	Rated V_{DRM} , $I_F = 0^{(2)}$	All			500	nA
dv/dt	Critical Rate of Rise of Off-State Voltage	$I_F = 0$ (Figure 10) ⁽³⁾	All	600			V/ μs

Transfer Characteristics

Symbol	Parameter	Test Conditions	Device	Min.	Typ.	Max.	Unit
I_{FT}	LED Trigger Current	Main Terminal Voltage = $3\text{ V}^{(4)}$	FODM3062, FODM3082 FODM3063, FODM3083			10 5	mA
I_H	Holding Current, Either Direction		All		300		μA
V_{TM}	Peak On-State Voltage, Either Direction	$I_F = \text{Rated } I_{\text{FT}}$, $I_{\text{TM}} = 100\text{ mA peak}$	All			3	V

Zero Crossing Characteristics

Symbol	Parameter	Test Conditions	Device	Min.	Typ.	Max.	Unit
V_{IH}	Inhibit Voltage, MT1-MT2 Voltage above which device will not trigger	$I_{\text{FT}} = \text{Rated } I_{\text{FT}}$	All			20	V
I_{DRM2}	Leakage in Inhibit State	$I_{\text{FT}} = \text{Rated } I_{\text{FT}}$, Rated V_{DRM} , Off-State	All			2	mA

Isolation Characteristics

Symbol	Parameter	Test Conditions	Device	Min.	Typ.	Max.	Unit
V_{ISO}	Steady State Isolation Voltage ⁽⁵⁾	1 Minute, R.H. = 40% to 60%	All	3,750			VAC_{RMS}

Notes:

- Test voltage must be applied within dv/dt rating.
- This is static dv/dt. See Figure 10 for test circuit. Commutating dv/dt is function of the load-driving thyristor(s) only.
- All devices are guaranteed to trigger at an I_F value less than or equal to max I_{FT} . Therefore, recommended operating I_F lies between max I_{FT} (10mA for FODM3062/82, 5mA for FODM3063/83) and absolute max I_F (60 mA).
- Steady state isolation voltage, V_{ISO} , is an internal device dielectric breakdown rating. For this test, pins 1 & 2 are common, and pins 3 & 4 are common.

Typical Performance Characteristics

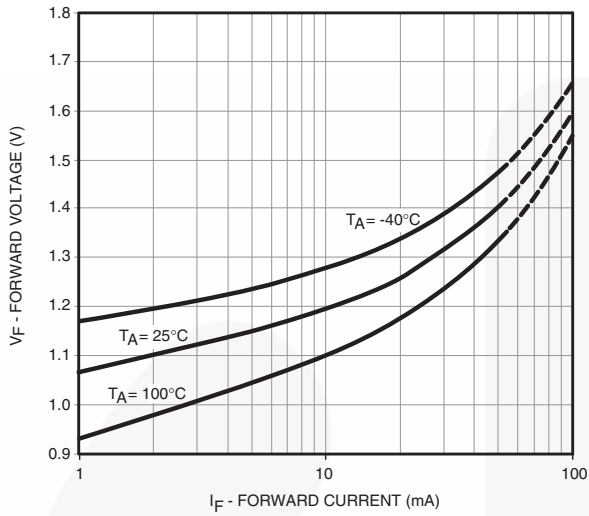

Fig. 3 LED Forward Voltage vs. Forward Current

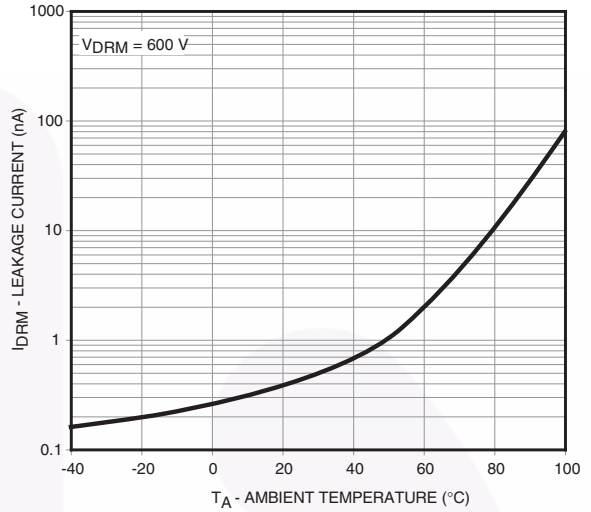

Fig. 4 Leakage Current vs. Ambient Temperature

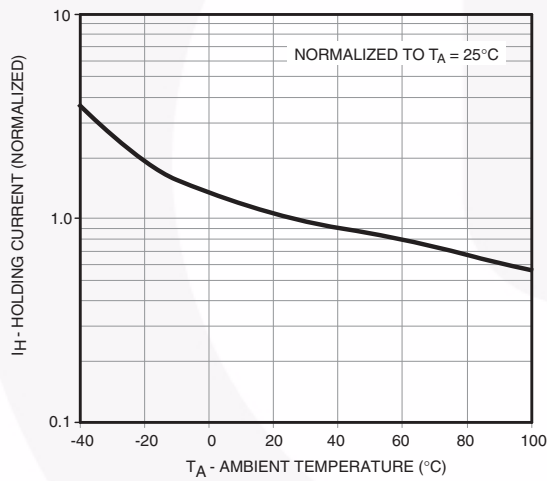

Fig. 5 Holding Current vs. Ambient Temperature

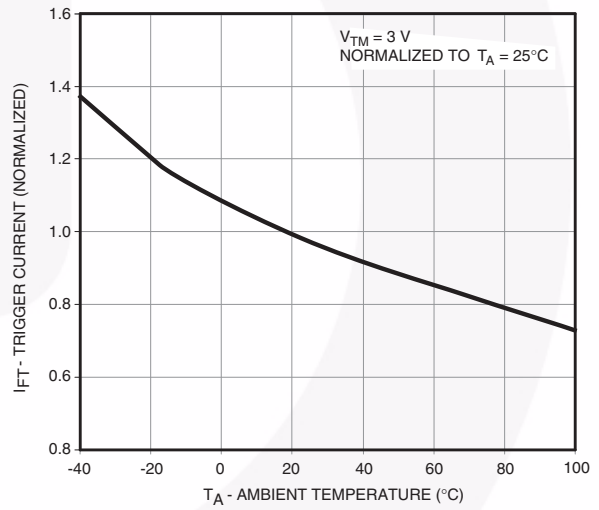

Fig. 6 Trigger Current vs. Ambient Temperature

Typical Performance Characteristics (Continued)

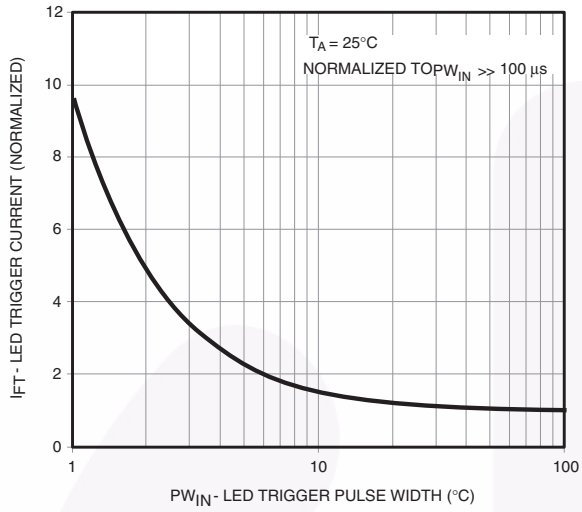

Fig. 7 LED Current Required to Trigger vs. LED Pulse Width

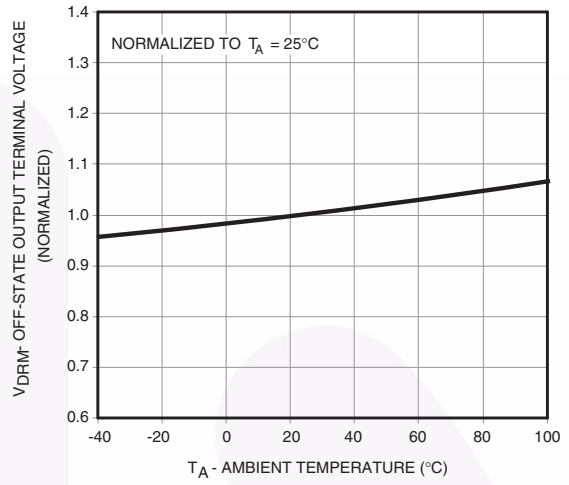

Fig. 8 Off-State Output Terminal Voltage vs. Ambient Temperature

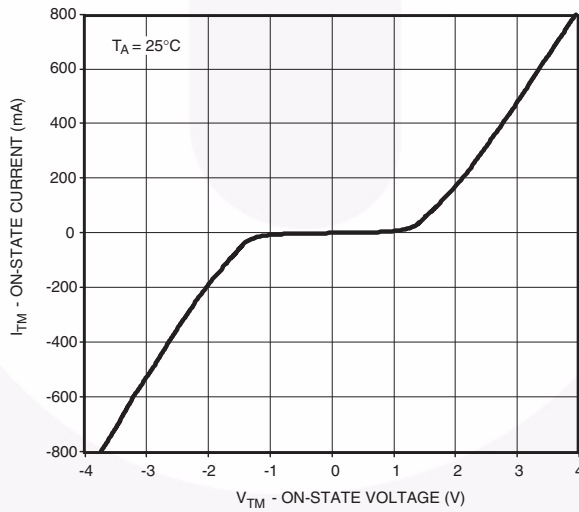

Fig. 9 On-State Characteristics

Typical Application Information

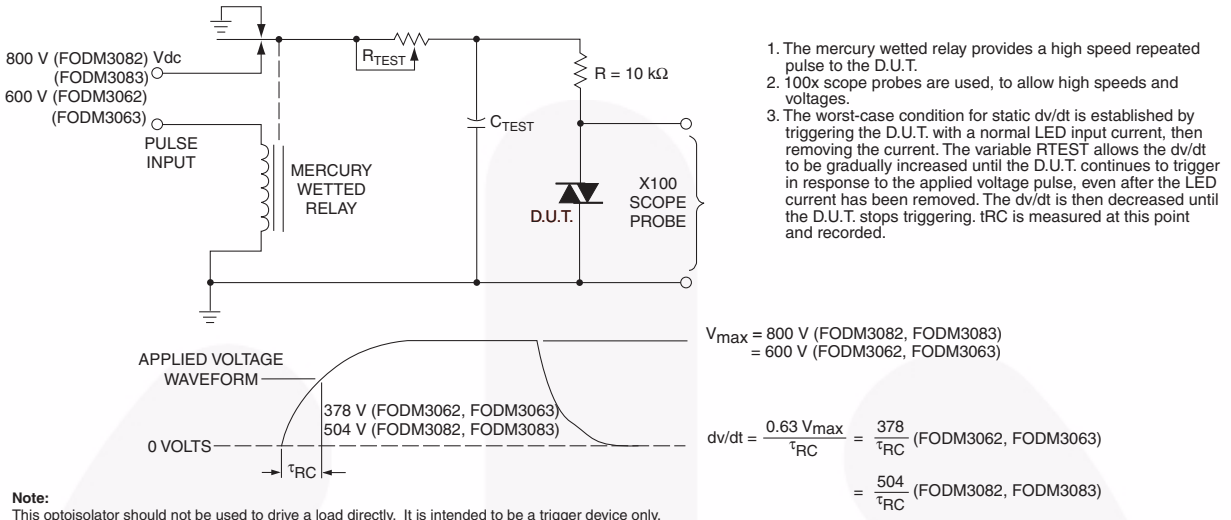

Figure 10. Static dv/dt Test Circuit

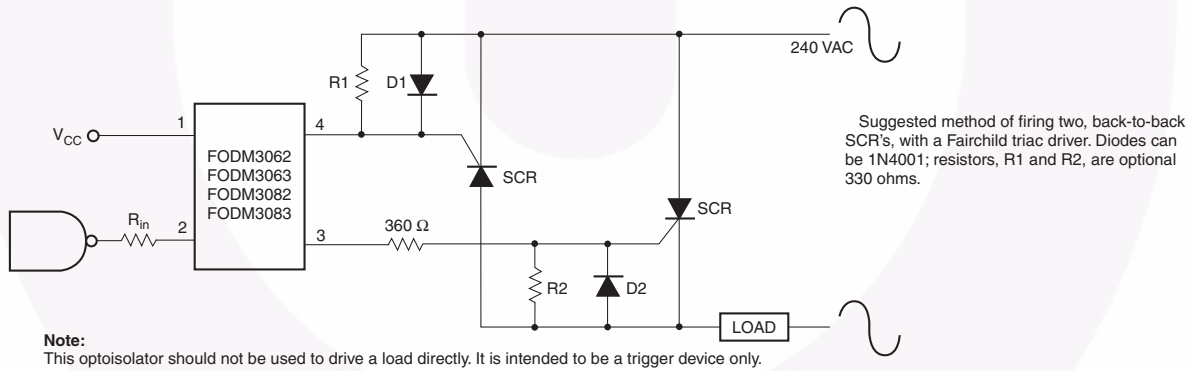

Figure 11. Inverse-Parallel SCR Driver Circuit (240 VAC)

Determining the Power Rating of the Series Resistors Used in a Zero-Cross Opto-TRIAC Driver Application

The following will present the calculations for determining the power dissipation of the current limiting resistors found in an opto-TRIAC driver interface.

Figure 12 shows a typical circuit to drive a sensitive gate four quadrant power TRIAC. This figure provides typical resistor values for a zero line cross detecting opto-TRIAC when operated from a mains voltage of 20 V to 240 V. The wattage rating for each resistor is not given because their dissipation is dependent upon characteristics of the power TRIAC being driven.

Recall that the opto-TRIAC is used to trigger a four quadrant power TRIAC. Please note that these opto-TRIACs are not recommended for driving “snubberless” three quadrant power TRIACs.

Under normal operation, the opto-TRIAC will fire when the mains voltage is lower than the minimum inhibit trigger voltage, and the LED is driven at a current greater than the maximum LED trigger current. As an example for the FODM3063, the LED trigger current should be greater than 5mA, and the mains voltage is less than 10 V peak. The inhibit voltage has a typical range of 10 V minimum and 20 V maximum. This means that if a sufficient LED current is flowing when the mains voltage is less than 10 V, the device will fire. If a trigger appears between 10 V and 20 V, the device may fire. If the trigger occurs after the mains voltage has reached 20 V_{peak}, the device will not fire.

The power dissipated from resistors placed in series with the opto-TRIAC and the gate of the power TRIAC is much smaller than one would expect. These current handling components only conduct current when the mains voltage is less than the maximum inhibit voltage. If the opto-TRIAC is triggered when the mains voltage is greater than the inhibit voltage, only the TRIAC leakage current will flow. The power dissipation in a 360 Ω resistor shown in Figure 12 is the product of the resistance (360 Ω) times the square of the current sum of main TRIAC’s gate current plus the current flowing gate to the MT2 resistor connection (330 Ω). This power calculation is further modified by the duty factor of the duration for this current flow. The duty factor is the ratio of the turn-on time of the main TRIAC to the sine of the single cycle time. Assuming a main TRIAC turn-on time of 50 μs and a 60 Hz mains voltage, the duty cycle is approximately 0.6 %. The opto-TRIAC only conducts current while triggering the main TRIAC. Once the main TRIAC fires, its on-state voltage is typically lower than the on-state sustaining voltage of the opto-TRIAC. Thus, once the main TRIAC fires, the opto-TRIAC is often shunted off. This situation results in very low power dissipation for both the 360 Ω and 330 Ω resistors, when driving a traditional four quadrant power TRIAC.

If a three quadrant “snubberless” TRIAC is driven by the opto-TRIAC, the calculations are different. When the main power TRIAC is driving a high power factor (resistive) load, it shuts off during the fourth quadrant.

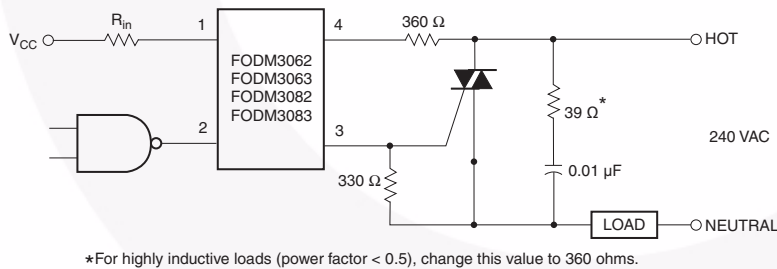

Typical circuit for use when hot line switching of 240 VAC is required. In this circuit the “hot” side of the line is switched and the load connected to the cold or neutral side. The load may be connected to either the neutral or hot line.

R_{in} is calculated so that I_F is equal to the rated I_{FT} of the part, 5 mA for the FODM3063/83 and 10 mA for the FODM3062/82. The 39 Ω resistor and 0.01 μF capacitor are for snubbing of the triac and may or may not be necessary depending upon the particular triac and load used.

Figure 12. Hot-Line Switching Application Circuit

If sufficient holding current is still flowing through the opto-TRIAC, the opto-TRIAC will turn-on and attempt to carry the power TRIACs load. This situation typically causes the opto-TRIAC to operate beyond its maximum current rating, and product and resistor failures typically result. For this reason, using an opto-TRIAC to drive a three quadrant “snubberless” power TRIAC is not recommended.

Power in the 360 Ω resistor, when driving a sensitive gate 4 quadrant power TRIAC:

$$\begin{aligned} I_{GT} &= 20 \text{ mA} \\ V_{GT} &= 1.5 \text{ V} \\ DF &= 0.6 \% \end{aligned}$$

$$P = (I_{GT} + V_{GT}/330 \Omega)^2 \times 360 \Omega \times DF$$

$$P = (20 \text{ mA} + 1.5/330 \Omega)^2 \times 360 \Omega \times 0.6 \% = 1.3 \text{ mW}$$

A 1/4 watt resistor is more than adequate for both the 360 Ω and 330 Ω resistors.

The real power in the snubber resistor is based upon the integral of the power transient present when the load commutes. A fast commuting transient may allow a peak current of 4 A to 8 A in the snubbing filter. For best results, the capacitor should be a non-polarized AC unit with a low ESR. The 39 Ω series resistor sets a time constant and limits the peak current. For a resistive load with a power factor near unity, the commutating transients will be small. This results in a very small peak current given the 0.01 μF capacitor's reactance. Normally, for fractional horse-power reactive loads, the resistor found in the snubber circuit will have a power rating from 1/2 W to 2 W. The resistor should be a low inductance type to adequately filter the high frequency transients.

Reflow Profile

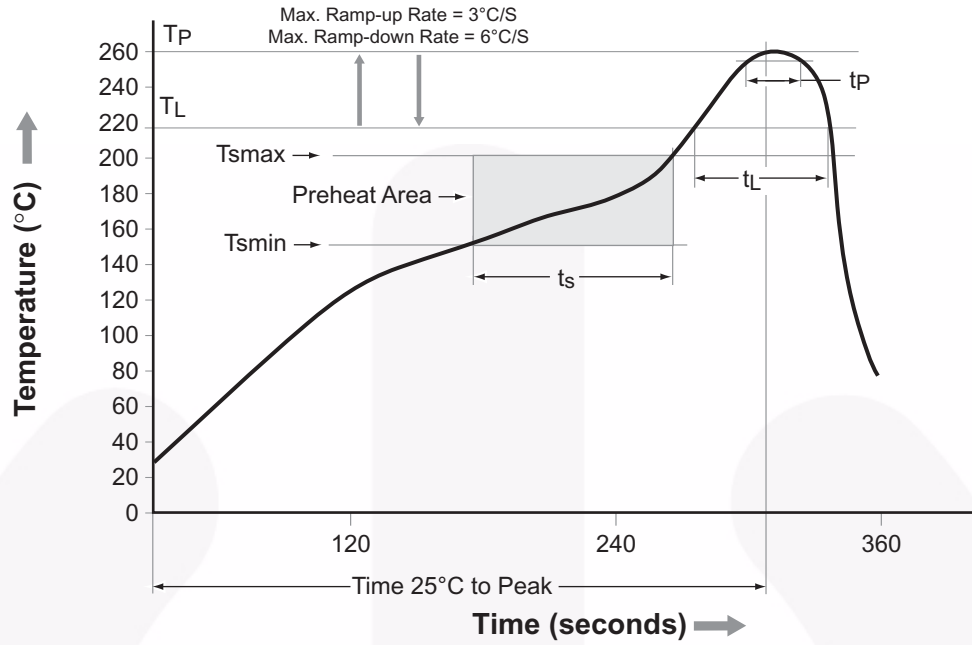

Profile Feature	Pb-Free Assembly Profile
Temperature Min. (T _{smín})	150°C
Temperature Max. (T _{smáx})	200°C
Time (t _s) from (T _{smín} to T _{smáx})	60–120 seconds
Ramp-up Rate (t _L to t _p)	3°C/second max.
Liquidous Temperature (T _L)	217°C
Time (t _L) Maintained Above (T _L)	60–150 seconds
Peak Body Package Temperature	260°C +0°C / -5°C
Time (t _p) within 5°C of 260°C	30 seconds
Ramp-down Rate (T _P to T _L)	6°C/second max.
Time 25°C to Peak Temperature	8 minutes max.

Ordering Information

Part Number	Package	Packing Method
FODM3063	Full Pitch Mini-Flat 4-Pin	Tube (100 units)
FODM3063R2	Full Pitch Mini-Flat 4-Pin	Tape and Reel (2500 Units)
FODM3063V	Full Pitch Mini-Flat 4-Pin, DIN EN/IEC60747-5-5 Option	Tube (100 Units)
FODM3063R2V	Full Pitch Mini-Flat 4-Pin, DIN EN/IEC60747-5-5 Option	Tape and Reel (2500 Units)

Note:

The product orderable part number system listed in this table also applies to the FODM3062, FODM3082 and FODM3083 products.

Marking Information

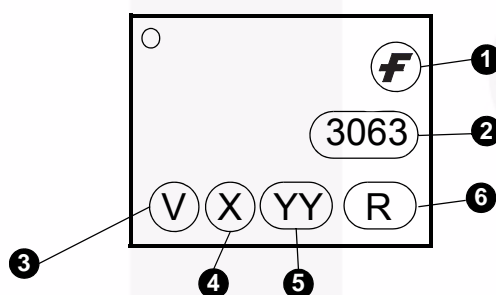
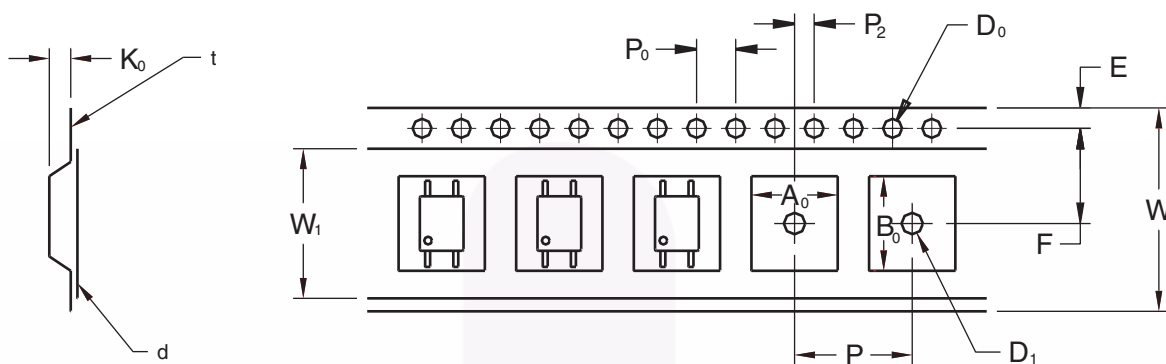

Figure 13. Top Mark

Table 1. Top Mark Definitions

1	Fairchild Logo
2	Device Number
3	DIN EN/IEC60747-5-5 Option (only appears on component ordered with this option)
4	One-Digit Year Code, e.g., "6"
5	Digit Work Week, Ranging from "01" to "53"
6	Assembly Package Code

Tape Specifications



		2.54 Pitch
Description	Symbol	Dimensions
Tape Width	W	12.00±0.4
Tape Thickness	t	0.35±0.02
Sprocket Hole Pitch	P ₀	4.00±0.20
Sprocket Hole Dia.	D ₀	1.55±0.20
Sprocket Hole Location	E	1.75±0.20
Pocket Location	F	5.50±0.20
	P ₂	2.00±0.20
Pocket Pitch	P	8.00±0.20
Pocket Dimension	A ₀	4.75±0.20
	B ₀	7.30±0.20
	K ₀	2.30±0.20
Pocket Hole Dia.	D ₁	1.55±0.20
Cover Tape Width	W ₁	9.20
Cover Tape Thickness	d	0.065±0.02
Max. Component Rotation or Tilt		20° max
Devices Per Reel		2500
Reel Diameter		330 mm (13")

Footprint Drawing for PCB Layout

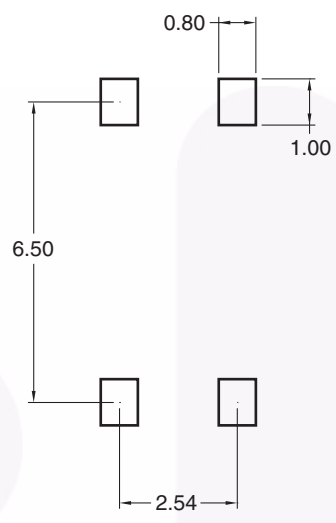

Note:
All dimensions are in mm.



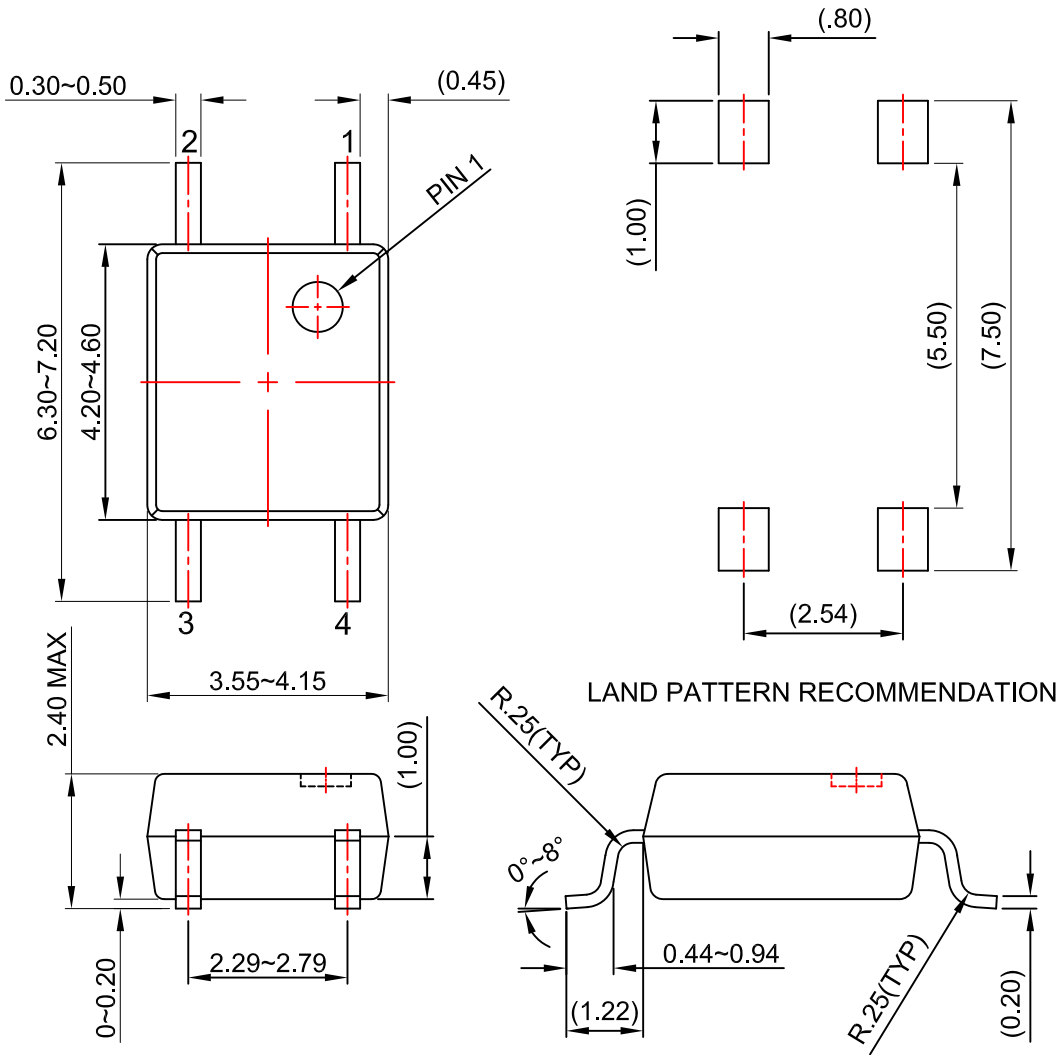

NOTES:

- A) NO STANDARD APPLIES TO THIS PACKAGE.
- B) ALL DIMENSIONS ARE IN MILLIMETERS.
- C) DIMENSIONS ARE EXCLUSIVE OF BURRS, MOLD FLASH, AND TIE BAR EXTRUSION
- D) DRAWING FILENAME AND REVISION: MKT-MFP04Crev3.





TRADEMARKS

The following includes registered and unregistered trademarks and service marks, owned by Fairchild Semiconductor and/or its global subsidiaries, and is not intended to be an exhaustive list of all such trademarks.

- | | | | |
|--------------------------|--|---------------------------------------|------------------|
| AccuPower™ | F-PFS™ | OPTOPLANAR® | SYSTEM GENERAL® |
| AttitudeEngine™ | FRFET® | Power Supply WebDesigner™ | TinyBoost® |
| Awinda® | Global Power Resource SM | PowerTrench® | TinyBuck® |
| AX-CAP®* | GreenBridge™ | PowerXS™ | TinyCalc™ |
| BitSiC™ | Green FPS™ | Programmable Active Droop™ | TinyLogic® |
| Build it Now™ | Green FPS™ e-Series™ | QFET® | TINYOPTO™ |
| CorePLUS™ | Gmax™ | QS™ | TinyPower™ |
| CorePOWER™ | GTO™ | Quiet Series™ | TinyPWM™ |
| CROSSVOL™ | IntelliMAX™ | RapidConfigure™ | TinyWire™ |
| CTL™ | ISOPLANAR™ | Saving our world, 1mW/W/kW at a time™ | TranSiC™ |
| Current Transfer Logic™ | Making Small Speakers Sound Louder and Better™ | SignalWise™ | TriFault Detect™ |
| DEUXPEED® | MegaBuck™ | SmartMax™ | TRUECURRENT®* |
| Dual Cool™ | MICROCOUPLER™ | SMART START™ | μSerDes™ |
| EcoSPARK® | MicroFET™ | Solutions for Your Success™ | UHC® |
| EfficientMax™ | MicroPak™ | SPM® | Ultra FRFET™ |
| ESBC™ | MicroPak2™ | STEALTH™ | UniFET™ |
| F [®] | MillerDrive™ | SuperFET® | VCX™ |
| Fairchild® | MotionMax™ | SuperSOT™-3 | VisualMax™ |
| Fairchild Semiconductor® | MotionGrid® | SuperSOT™-6 | VoltagePlus™ |
| FACT Quiet Series™ | MTi® | SuperSOT™-8 | XST™ |
| FACT® | MTx® | SupreMOS® | Xsens™ |
| FastvCore™ | MVN® | SyncFET™ | 仙童® |
| FETBench™ | mWSaver® | Sync-Lock™ | |
| FPS™ | OptoHiT™ | | |
| | OPTOLOGIC® | | |

* Trademarks of System General Corporation, used under license by Fairchild Semiconductor.

DISCLAIMER

FAIRCHILD SEMICONDUCTOR RESERVES THE RIGHT TO MAKE CHANGES WITHOUT FURTHER NOTICE TO ANY PRODUCTS HEREIN TO IMPROVE RELIABILITY, FUNCTION, OR DESIGN. TO OBTAIN THE LATEST, MOST UP-TO-DATE DATASHEET AND PRODUCT INFORMATION, VISIT OUR WEBSITE AT [HTTP://WWW.FAIRCHILDSEMI.COM](http://www.fairchildsemi.com). FAIRCHILD DOES NOT ASSUME ANY LIABILITY ARISING OUT OF THE APPLICATION OR USE OF ANY PRODUCT OR CIRCUIT DESCRIBED HEREIN; NEITHER DOES IT CONVEY ANY LICENSE UNDER ITS PATENT RIGHTS, NOR THE RIGHTS OF OTHERS. THESE SPECIFICATIONS DO NOT EXPAND THE TERMS OF FAIRCHILD'S WORLDWIDE TERMS AND CONDITIONS, SPECIFICALLY THE WARRANTY THEREIN, WHICH COVERS THESE PRODUCTS.

AUTHORIZED USE

Unless otherwise specified in this data sheet, this product is a standard commercial product and is not intended for use in applications that require extraordinary levels of quality and reliability. This product may not be used in the following applications, unless specifically approved in writing by a Fairchild officer: (1) automotive or other transportation, (2) military/aerospace, (3) any safety critical application – including life critical medical equipment – where the failure of the Fairchild product reasonably would be expected to result in personal injury, death or property damage. Customer's use of this product is subject to agreement of this Authorized Use policy. In the event of an unauthorized use of Fairchild's product, Fairchild accepts no liability in the event of product failure. In other respects, this product shall be subject to Fairchild's Worldwide Terms and Conditions of Sale, unless a separate agreement has been signed by both Parties.

ANTI-COUNTERFEITING POLICY

Fairchild Semiconductor Corporation's Anti-Counterfeiting Policy. Fairchild's Anti-Counterfeiting Policy is also stated on our external website, www.fairchildsemi.com, under Terms of Use

Counterfeiting of semiconductor parts is a growing problem in the industry. All manufacturers of semiconductor products are experiencing counterfeiting of their parts. Customers who inadvertently purchase counterfeit parts experience many problems such as loss of brand reputation, substandard performance, failed applications, and increased cost of production and manufacturing delays. Fairchild is taking strong measures to protect ourselves and our customers from the proliferation of counterfeit parts. Fairchild strongly encourages customers to purchase Fairchild parts either directly from Fairchild or from Authorized Fairchild Distributors who are listed by country on our web page cited above. Products customers buy either from Fairchild directly or from Authorized Fairchild Distributors are genuine parts, have full traceability, meet Fairchild's quality standards for handling and storage and provide access to Fairchild's full range of up-to-date technical and product information. Fairchild and our Authorized Distributors will stand behind all warranties and will appropriately address any warranty issues that may arise. Fairchild will not provide any warranty coverage or other assistance for parts bought from Unauthorized Sources. Fairchild is committed to combat this global problem and encourage our customers to do their part in stopping this practice by buying direct or from authorized distributors.

PRODUCT STATUS DEFINITIONS

Definition of Terms

Datasheet Identification	Product Status	Definition
Advance Information	Formative / In Design	Datasheet contains the design specifications for product development. Specifications may change in any manner without notice.
Preliminary	First Production	Datasheet contains preliminary data; supplementary data will be published at a later date. Fairchild Semiconductor reserves the right to make changes at any time without notice to improve design.
No Identification Needed	Full Production	Datasheet contains final specifications. Fairchild Semiconductor reserves the right to make changes at any time without notice to improve the design.
Obsolete	Not In Production	Datasheet contains specifications on a product that is discontinued by Fairchild Semiconductor. The datasheet is for reference information only.

Rev. I77