



TEF6901A

Integrated car radio

Rev. 02 — 10 July 2006

Product data sheet

1. General description

The TEF6901A is a single chip car radio integrated circuit with FM/AM tuner, stereo decoder, weak signal processing and audio processing. Radio Data System (RDS)/Radio Broadcast Data System (RBDS) demodulator for radio data reception is included.

FM tuner with double conversion to IF1 = 10.7 MHz and IF2 = 450 kHz with integrated image rejection for both IF1 and IF2; integrated channel filter with variable bandwidth control; capable of US FM, Europe FM, Japan FM and Eastern Europe FM. AM tuner with double conversion to IF1 = 10.7 MHz and IF2 = 450 kHz; capable of Long Wave (LW), Medium Wave (MW) and full range Short Wave (SW) (11 m to 120 m bands).

Multiplex (MPX) stereo decoder, ignition noise blanker and extensive weak signal processing.

Audio processing with flexible source selection, volume, balance, fader, input gain control and inaudible tuning mute. Integrated audio filters for bass and treble and loudness control function.

The device can be controlled via the fast-mode I²C-bus (400 kHz) and includes autonomous tuning functions for easy control without microcontroller timing. No manual alignments are required.

2. Features

- FM Radio Frequency (RF) front-end with large dynamic range
- Integrated FM channel filter with controlled bandwidth
- Fully integrated FM demodulator
- Fully integrated stereo decoder with high immunity for birdy noise
- FM noise blanker with adaptive detection at MPX and level
- Signal quality detection: level, AM wideband, frequency deviation, ultrasonic noise/adjacent channel
- FM weak signal processing: stereo blend, high cut control and soft mute
- AM RF Automatic Gain Control (AGC) control circuit for external cascode AGC and PIN diode AGC
- Dual AM noise blanking system
- AM weak signal processing: high cut control and soft mute
- Low phase noise local oscillator
- In-lock detection for optimized adaptive Phase-Locked Loop (PLL) tuning speed
- Crystal oscillator reference with low harmonics
- Inaudible soft slope tuning mute for AM and FM
- Sequential state machine supporting each tuning action

PHILIPS

- Integrated RDS/RBDS radio data demodulator
- Flexible audio input source selection
- Integrated audio processing and tone filtering
- Treble, bass and loudness tone control
- Volume, balance, fader and input gain control
- Audio controls with Audio Step Interpolation (ASI) for pop-free function
- Compact Disc (CD) dynamics compression
- Volume Unit (VU)-meter audio level read-out

3. Quick reference data

Table 1. Quick reference data

Symbol	Parameter	Conditions	Min	Typ	Max	Unit
Supply voltage						
V _{CC}	analog supply voltage on pins VCC, VCCPLL, VCCVCO, VCCRF, AMMIX2OUT1, AMMIX2OUT2, MIX1OUT1 and MIX1OUT2		8	8.5	9	V
Supply current in FM mode						
I _{CC}	total supply current inclusive I _{V60}		-	102	-	mA
Supply current in AM mode						
I _{CC}	total supply current inclusive I _{V60}		-	89	-	mA
AM overall system parameters						
f _{tune}	AM tuning frequency	LW	144	-	288	kHz
		MW	522	-	1710	kHz
		SW	2.3	-	26.1	MHz
V _{sens}	sensitivity voltage	f _{RF} = 990 kHz; m = 0.3; f _{mod} = 1 kHz; B _{AF} = 2.15 kHz; (S+N)/N = 26 dB; dummy aerial 15 pF/60 pF	-	50	-	μV
S/N	ultimate signal-to-noise ratio		54	58	-	dB
THD	total harmonic distortion	200 μV < V _{RF} < 1 V; m = 0.8; f _{AF} = 400 Hz	-	0.4	1	%
IP3	3rd-order intercept point	Δf = 40 kHz	-	130	-	dBμV
FM overall system parameters						
f _{tune}	FM tuning frequency		65	-	108	MHz
V _{sens}	sensitivity voltage (RF input voltage at (S+N)/N = 26 dB)	Δf = 22.5 kHz; f _{mod} = 1 kHz; DEMP = 1; B = 300 Hz to 22 kHz; measured with 75 Ω dummy antenna and test circuit	-	2	-	μV
(S+N)/N	maximum signal plus noise-to-noise ratio of MPXAM output voltage	V _i = 3 mV; Δf = 22.5 kHz; f _{mod} = 1 kHz; DEMP = 1; B = 300 Hz to 22 kHz; measured with 75 Ω dummy antenna and test circuit	-	60	-	dB
THD	total harmonic distortion	Δf = 75 kHz	-	0.5	1	%
IP3	3rd-order intercept point	Δf = 400 kHz	-	120	-	dBμV

Table 1. Quick reference data ...continued

Symbol	Parameter	Conditions	Min	Typ	Max	Unit
Stereo decoder path						
α_{CS}	channel separation	$f_{FMMPX} = 1 \text{ kHz}$	40	-	-	dB
S/N	signal-to-noise ratio	$f_{MPXAMIN} = 20 \text{ Hz to } 15 \text{ kHz}$; referenced to 1 kHz at 91 % FM modulation; DEMP = 1	70	-	-	dB
THD	total harmonic distortion	FM mode; DEMP = 1; measured with 15 kHz brick-wall low-pass filter; $f_{MPXAMIN} = 200 \text{ Hz to } 15 \text{ kHz}$	-	-	0.3	%
Tone/volume control						
$V_{i(max)}$	maximum input voltage	THD = 0.2 %; $G_{vol} = -6 \text{ dB}$; pins INAL, INAR, INAC, INBL, INBR, INC and IND	2	-	-	V
THD	total harmonic distortion	configured as non-inverting, single ended inputs; $f_{audio} = 20 \text{ Hz to } 10 \text{ kHz}$; $V_i = 1 \text{ V (RMS)}$	-	0.02	0.1	%
G_{vol}	volume/balance gain control	see Table 83				
		maximum setting	[1]	-	20	- dB
		minimum setting	[1]	-	-75	- dB
$G_{step(vol)}$	step resolution		-	1	-	dB
G_{treble}	treble gain control	TRE[2:0] = 111; TREM = 1	-	14	-	dB
		TRE[2:0] = 111; TREM = 0	-	-14	-	dB
$G_{step(treble)}$	step resolution gain		-	2	-	dB
G_{bass}	bass gain control	BAS[3:0] = 0111; BAM = 1	-	14	-	dB
		BAS[3:0] = 0111; BAM = 0	-	-14	-	dB
$G_{step(bass)}$	step resolution gain		-	2	-	dB

[1] The input gain setting ING and the volume setting VOL define the overall volume. The overall range is limited to -83 dB to +28 dB. For values > +28 dB the actual value is +28 dB. For overall values < -83 dB the actual value is mute.

4. Ordering information

Table 2. Ordering information

Type number	Package		Version
	Name	Description	
TEF6901AH	QFP64	plastic quad flat package; 64 leads (lead length 1.6 mm); body 14 × 14 × 2.7 mm	SOT393-1

5. Block diagram

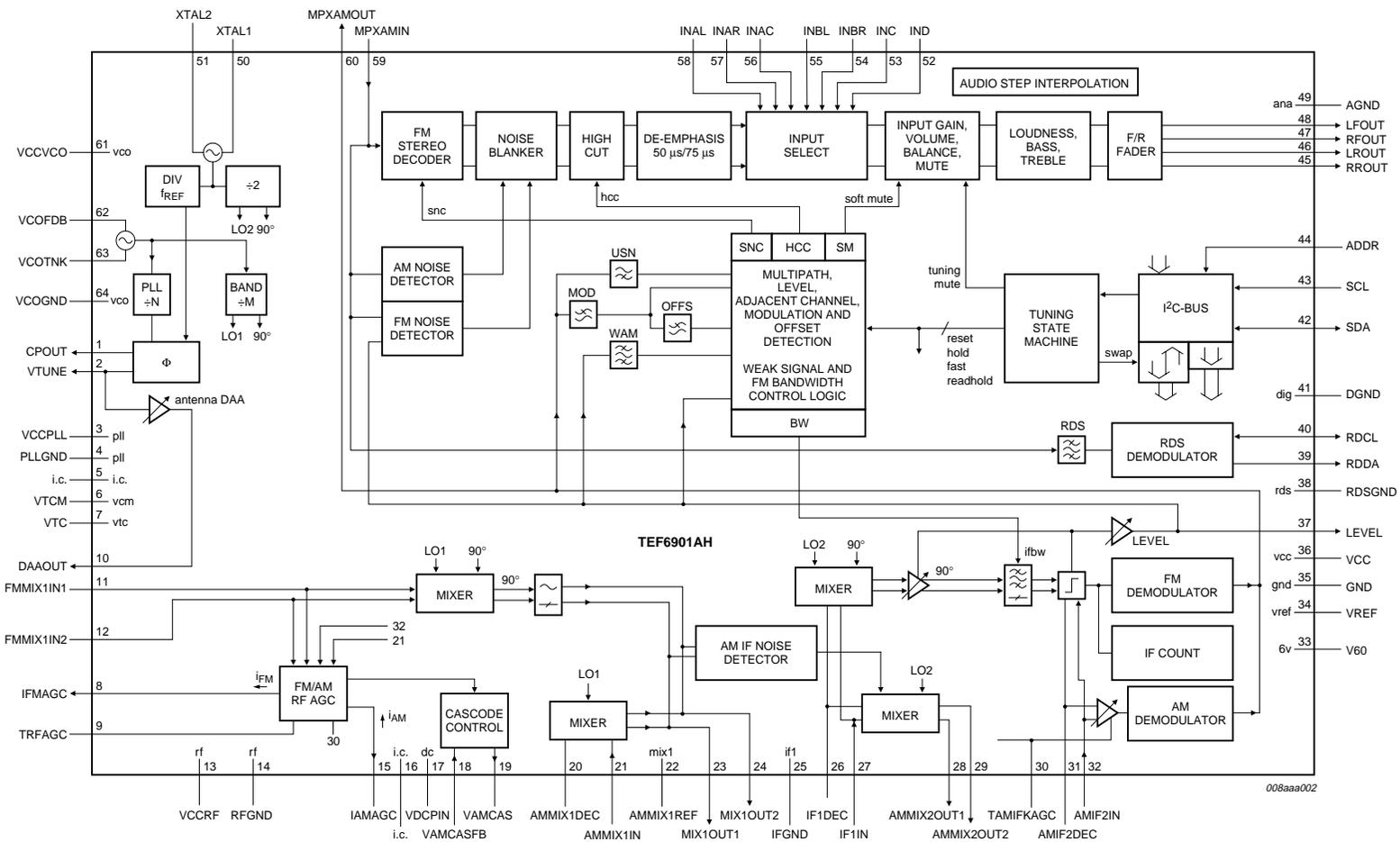

Fig 1. Block diagram of TEF6901AH

6. Pinning information

6.1 Pinning

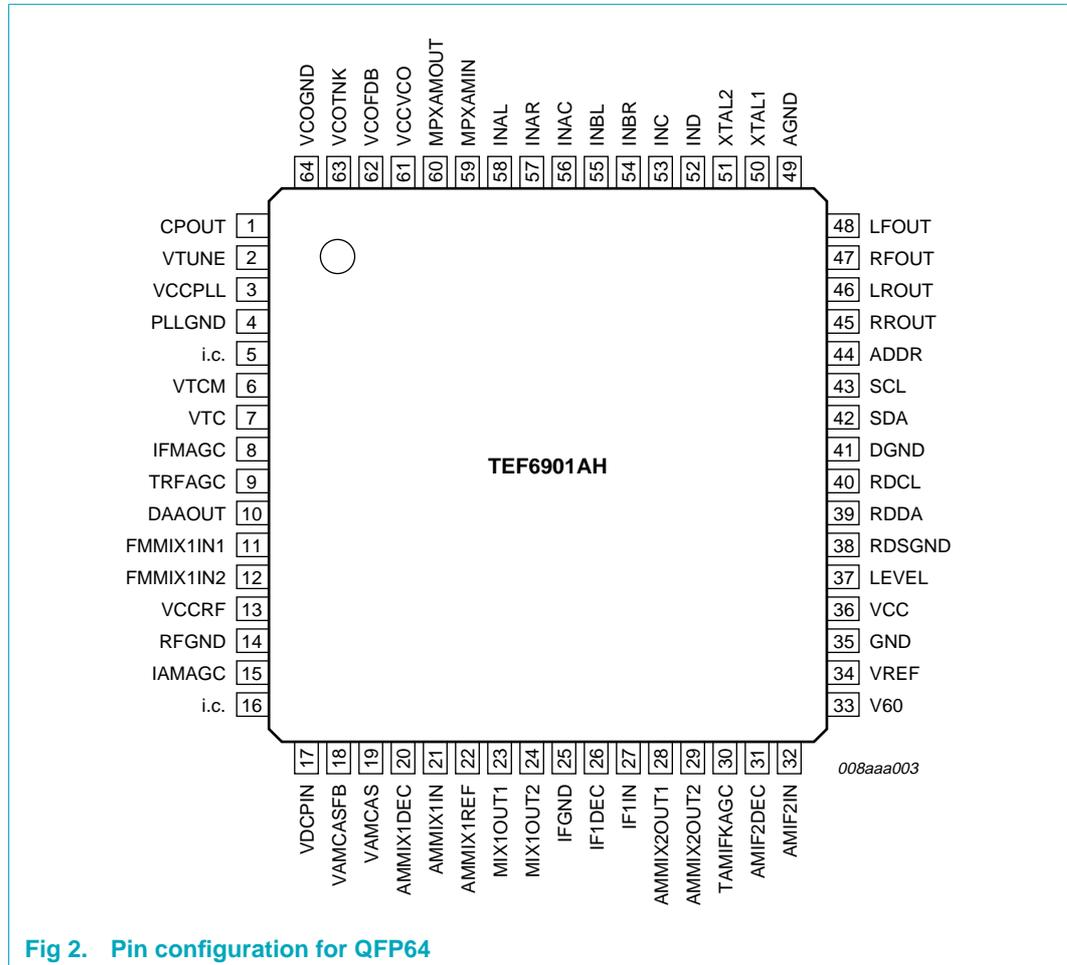

Fig 2. Pin configuration for QFP64

6.2 Pin description

Table 3. Pin description

Symbol	Pin	Description
CPOUT	1	charge pump output
VTUNE	2	tuning voltage; 3 mA charge pump output
VCCPLL	3	tuning PLL supply voltage
PLLGND	4	PLL ground
i.c.	5	internally connected; leave open
VTCM	6	Intermediate Frequency (IF) filter reference voltage
VTC	7	IF filter center voltage
IFMAGC	8	PIN diode current FM AGC
TRFAGC	9	FM and AM RF AGC time constant
DAAOUT	10	antenna Digital Auto Alignment (DAA) output

Table 3. Pin description ...continued

Symbol	Pin	Description
FMMIX1IN1	11	FM mixer 1 input 1
FMMIX1IN2	12	FM mixer 1 input 2
VCCRF	13	AM/FM RF supply voltage
RFGND	14	RF ground
IAMAGC	15	PIN diode current AMAGC
i.c.	16	internally connected; leave open
VDCPIN	17	AM PIN diode DC bias voltage
VAMCASFB	18	feedback for cascode AM AGC
VAMCAS	19	cascode AM AGC
AMMIX1DEC	20	AM mixer 1 decoupling
AMMIX1IN	21	AM mixer 1 input
AMMIX1REF	22	AM mixer 1 reference
MIX1OUT1	23	AM and FM mixer 1 output 1 at IF1
MIX1OUT2	24	AM and FM mixer 1 output 2 at IF1
IFGND	25	IF ground
IF1DEC	26	AM and FM mixer 2 decoupling
IF1IN	27	AM and FM mixer 2 input
AMMIX2OUT1	28	AM mixer 2 output 1 at IF2
AMMIX2OUT2	29	AM mixer 2 output 2 at IF2
TAMIFKAGC	30	AM IF AGC and FM keyed AGC time constant
AMIF2DEC	31	AM IF2 input decoupling
AMIF2IN	32	AM IF2 input
V60	33	input for FM filter and demodulator supply current
VREF	34	reference voltage for noise decoupling
GND	35	ground
VCC	36	8.5 V supply voltage
LEVEL	37	AM and FM level voltage output
RDSGND	38	RDS ground
RDDA	39	RDS/RBDS demodulator data and quality output
RDCL	40	RDS/RBDS demodulator clock input or output
DGND	41	digital ground
SDA	42	I ² C-bus Serial Data (SDA) input and output
SCL	43	I ² C-bus Serial Clock (SCL) input
ADDR	44	I ² C-bus slave address select input
RROUT	45	right rear audio output
LROUT	46	left rear audio output
RFOUT	47	right front audio output
LFOUT	48	left front audio output
AGND	49	analog ground
XTAL1	50	crystal oscillator 1
XTAL2	51	crystal oscillator 2

Table 3. Pin description ...continued

Symbol	Pin	Description
IND	52	audio input D, signal input
INC	53	audio input C, common mode or signal input
INBR	54	audio input B, right channel
INBL	55	audio input B, left channel
INAC	56	audio input A, left channel inverted (or other options)
INAR	57	audio input A, right channel
INAL	58	audio input A, left channel
MPXAMIN	59	MPX and AM audio input to radio processing
MPXAMOUT	60	MPX and AM audio output from tuner part
VCCVCO	61	Voltage-Controlled Oscillator (VCO) supply voltage
VCOFDB	62	VCO feedback
VCOTNK	63	VCO tank circuit
VCOGND	64	VCO ground

7. Functional description

7.1 FM mixer 1

The FM quadrature mixer 1 converts FM RF (65 MHz to 108 MHz) to an IF frequency of 10.7 MHz. The FM mixer provides image rejection and a large dynamic range. Low and high injection Local Oscillator (LO) can be selected via the I²C-bus.

7.2 FM RF AGC

AGC detection at the FM front-end mixer input with programmable threshold. When the threshold is exceeded, the PIN diode drive circuit sources a current to an external PIN diode circuit, keeping the RF signal level constant. Keyed AGC function is selectable via the I²C-bus and uses the in-band level information derived from the limiter. The AGC PIN diode drive circuit can optionally deliver a fixed current; this local mode can be used for search tuning on absolute RF levels. In AM mode, the FM AGC PIN diode drive circuit can be set to source a fixed current into the external FM PIN diode circuitry.

7.3 FM mixer 2

The FM quadrature mixer 2 converts 10.7 MHz IF1 to 450 kHz IF2 and includes image rejection with the integrated channel filter. Two gain settings can be selected to compensate for high ceramic filter insertion loss.

7.4 FM IF2 channel filter

The order and dynamic range of the FM IF2 channel filter is designed for operation with only one external ceramic filter. The filter characteristic is optimized to combine high selectivity with low distortion. The bandwidth of the filter can be set to a range of fixed settings or automatically via the bandwidth control algorithm. When the automatic mode is selected the bandwidth depends on the signal conditions.

7.5 FM limiter and level detection

The limiter amplifies the IF filter output signal, removes AM modulations from the IF signal and supplies a well defined signal for the FM demodulator. From the limiter also the Radio Signal Strength Information (RSSI) is derived which is converted to a suitable level voltage with minimum temperature drift.

7.6 FM demodulator

The fully integrated FM demodulator converts the IF signal from the limiter to the FM multiplex output signal with low distortion.

7.7 Center frequency and bandwidth tuning and center frequency DAA

The center frequency as well as the bandwidth of both the IF filter and demodulator are coupled to the crystal reference frequency. A coarse alignment (IFCAP) sets the circuit operating range and the center frequency fine adjustment is achieved with a 6-bit alignment (IFCF).

7.8 Bandwidth control algorithm

The bandwidth of the IF filter can be selected with 5 bits, directly via I²C-bus or automatically via the bandwidth control algorithm. The bandwidth control algorithm detects the amount of adjacent channel interference, the deviation of the desired signal, detuning, multipath and signal strength to define the optimum bandwidth setting of the IF filter. Flexibility on the algorithm settings is provided via the I²C-bus control.

7.9 VCO and dividers

The varactor tuned LC oscillator together with the dividers provides the local oscillator signal for both AM and FM front-end mixers. The VCO has an operating frequency of approximately 160 MHz to 250 MHz. In FM mode the VCO frequency is divided by 2 or 3. These dividers generate in-phase and quadrature-phase output signals used in the FM front-end mixer for image rejection. In AM mode the VCO frequency is divided by 6, 8, 10, 16 or 20 depending on the selected AM band. The amplitude of the VCO is controlled by a digital AGC to ensure a safe oscillation start-up at a wide range of the loaded Q.

7.10 Crystal oscillator

The crystal oscillator provides a 20.5 MHz signal. A divider-by-two generates in-phase and quadrature-phase mixer frequencies for the conversion from IF1 to IF2 including image rejection. The reference divider generates from the crystal frequency various reference frequencies for the tuning PLL. Also timing signals for the sequential machine as well as references for the integrated FM channel filter, the stereo decoder and the integrated audio filters and the RDS demodulator are derived from the crystal reference.

7.11 Tuning PLL

The tuning PLL locks the VCO frequency divided by the programmable divider ratio to the reference frequency. Due to the combination of different charge pump signals in the PLL loop filter, the loop parameters are adapted dynamically. Tuning to different RF frequencies is done by changing the programmable divider ratio. The tuning step size is selected with the reference frequency divider setting.

7.12 Antenna DAA

For FM operation the antenna Digital Auto Alignment (DAA) measures the VCO tuning voltage and multiplies it with a factor defined by the 7-bit DAA setting to generate a tuning voltage for the FM antenna tank circuit (RF selectivity). In AM mode the DAA setting controls a fixed voltage.

7.13 AM RF AGC control

The AM front-end is designed for the application of an external Junction Field Effect Transistor (JFET) low noise amplifier with cascode AGC and PIN diode AGC both controlled by an integrated AGC control circuit. Four AGC thresholds of the detector at the first mixer input are selectable via I²C-bus. Detectors at the RF mixer input and at the AMIF2 input prevent undesired overload (see [Figure 40](#)). AGC information can be read out via I²C-bus. The PIN diode current drive circuit includes a pull-up current source for reverse biasing of the PIN diode, when the AGC is not active to achieve a low parasitic capacitance.

7.14 AM mixer 1

The large dynamic range AM mixer converts AM RF (144 kHz to 26.1 MHz) to an IF frequency of 10.7 MHz.

7.15 AM IF noise blanker

The spike detection for the AM IF noise blanker is at the output of the AM front-end mixer. Blanking is realized at the second AM mixer.

7.16 AM IF AGC amplifier and demodulator

The 450 kHz IF2 signal after the ceramic channel selection filter is amplified by the IF AGC amplifier and demodulated.

7.17 AM level detection

The IF2 signal used for AM IF AGC and demodulation is also used in the limiter circuit for in-band level detection.

7.18 AM and FM level DAA

The start and slope of the level detector output are programmable to achieve level information independent on gain spread in the signal channel.

7.19 AM and FM IF counter

The output signal from the limiter is used for IF counting in both AM and FM.

7.20 Tuning mute

A soft slope tuning mute is controlled by the sequential machine for different tuning actions to eliminate audible effects of tuning and band switching.

7.21 FM stereo decoder

A low-pass filter provides additional suppression of high frequency interferences at the stereo decoder input and the necessary signal delay for FM noise blanking.

The MPX signal is decoded in the stereo decoder part. An integrated oscillator and pilot PLL is used for the regeneration of the 38 kHz subcarrier. The required 19 kHz and 38 kHz signals are generated by division of the oscillator output signal in a logic circuitry.

By means of a 19 kHz quadrature detector the pilot PLL oscillator frequency is locked to the incoming 19 kHz stereo pilot. A pilot level voltage derived from a 19 kHz in-phase detector is used for stereo detection and for generation of an anti-phase 19 kHz signal to remove the pilot tone from the audio signal.

The signal is then decoded in the decoder part. The L-R side signal is demodulated using the 38 kHz subcarrier and combined with the main signal to the left and right audio channel. A fine adjustment is done by adjusting the gain of the L-R signal. A smooth mono to stereo takeover is achieved by controlling the efficiency of the matrix by the SNC signal from the weak signal processing block.

7.22 FM and AM AF noise blanker

The FM or AM tuner operation selects between two noise blanker operations optimized for FM or AM ignition noise suppression.

In FM mode the noise blanker operates as a modified sample and hold circuit with ultrasonic noise detection on MPX and detection of noise spikes on level.

In AM mode the audio signal is muted during the interference pulse triggered by slew-rate detection of the audio signal.

7.23 Fixed high cut and high cut control

The high cut part is a low-pass filter circuit with seven bandwidth settings. The cut-off frequencies of the filter curves can be selected to match different application requirements (fixed high cut).

The high cut circuit also provides a dynamic control of the filter response, the High Cut Control (HCC). This function is controlled by the HCC signal from the weak signal processing.

7.24 De-emphasis

The signal passes the low-pass filter de-emphasis block and is then fed to the source selector. The de-emphasis time constant can be selected between the standards of 50 μ s and 75 μ s.

7.25 Weak signal processing

The weak signal processing block detects quality degradations in the incoming signal and controls the processing of the audio signal accordingly. The weak signal processing block has three different quality criteria: The average value of the level voltage, AM components on the level voltage (WAM = wideband AM) and high frequency components in the MPX signal (USN = ultrasonic noise).

In the weak signal processing block these signals are combined in specific ways and used for the generation of control signals for soft mute, stereo blend (stereo noise control, SNC) and HCC. Detector time constants of soft mute, HCC and SNC can be selected independently.

In AM mode soft mute and HCC are controlled by the average value of the level voltage.

7.26 Audio step interpolation

The tone/volume blocks of source selector, volume/balance, bass/loudness, fader and output mute include the Audio Step Interpolation (ASI) function. This minimizes audible pops by smoothing the transitions in the audio signal during the switching of the controls.

7.27 Source selector

The source selector selects one out of several input sources:

- One internal stereo signal (AM/FM tuner)
- Seven input pins allow many combinations of external sources by means of flexible input selection

Three of the seven input pins can connect to:

- 1 stereo signal with ground input for common mode rejection (CD)
- 1 stereo signal and 1 mono signal

Four more input pins can connect to:

- 1 stereo signal (AUX) and 1 mono signal with common mode rejection or differential input (PHONE)
- 1 stereo signal (AUX) and 2 mono signals (e.g. NAV and BEEP)
- 2 stereo signals (AUX and AUX-2)
- 1 stereo signal with common mode rejection (CD-2) and 1 mono signal (e.g. BEEP)
- 1 stereo signal with differential input (CD-symmetrical)

7.28 VU-meter read

The input audio level of external sources can read out via the I²C-bus. Audio level information is available on a logarithmic scale. In radio mode the AM or FM modulation index is available in the same way.

7.29 Volume and balance

The volume/balance control is used for volume setting and also for balance adjustment. The control range of the volume/balance control is between +20 dB and –75 dB in steps of 1 dB.

7.30 CD compression

Dynamic volume compression is available for external input sources. This option is generally used for audio from CD or other digital formats to reduce the very high dynamic range of these signals into a range suitable for the car environment.

7.31 Bass

The bass tone control stage controls the low audio frequencies with a modified shelf curve response. The control range is between +14 dB and -14 dB in steps of 2 dB. Four different filter cut-off frequencies can be selected.

7.32 Treble

The treble tone control stage controls the high audio frequencies with a shelf curve response. The control range is between +14 dB and -14 dB in steps of 2 dB. Four different filter cut-off frequencies can be selected.

7.33 Loudness

An integrated loudness function can be activated which controls bass and treble in relation to the user volume setting. The control range of the bass frequencies is limited to 20 dB and the optional treble range to 4 dB. Different volume ranges can be selected for the loudness control.

7.34 Fader

The fader is located at the end of the tone/volume chain. The balance between the front and rear channel can be controlled by attenuation of either the front or the rear channel. Control range is 0 dB to -64 dB with a step size of 1 dB. Optionally the fader attenuation can be activated for front and rear channels together.

7.35 RDS/RBDS demodulator

The RDS demodulator recovers and regenerates the continuously transmitted RDS or RBDS data stream that may be part of the FM MPX signal and provides the signals clock (RDCL) and data (RDDA) for further processing by a hardware or software RDS decoder. Unbuffered demodulator output and buffered 16-bit output mode are available. The output modes are compatible with stand-alone demodulator devices as well as digital and analog signal processor standards. In case of buffered output mode additional RDS Quality (RDQ) demodulation quality information is available optional.

8. I²C-bus protocol

SDA and SCL HIGH and LOW internal thresholds are specified according to both 2.5 V and 3.3 V I²C-bus, however also SDA and SCL signals from a 5 V bus are supported. The maximum I²C-bus communication speed is 400 kbit/s in accordance with the I²C-bus fast mode specification.

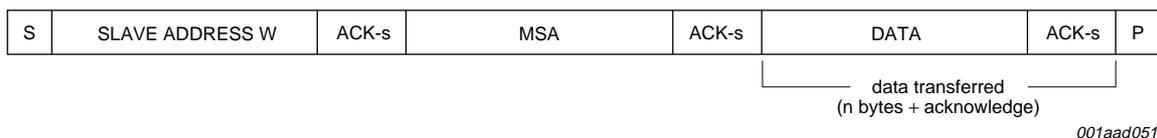

Fig 3. Write mode

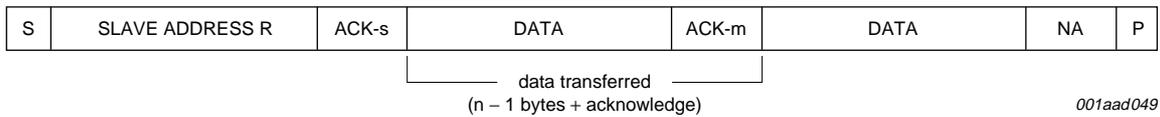

Fig 4. Read mode

Table 4. Description of I²C-bus format

Code	Description
S	START condition
Slave address W	1100 0000b for pin ADDR grounded 1100 0010b for pin ADDR floating
Slave address R	1100 0001b for pin ADDR grounded 1100 0011b for pin ADDR floating
ACK-s	acknowledge generated by the slave
ACK-m	acknowledge generated by the master
NA	not acknowledge generated by the master
MSA	mode and subaddress byte
Data	data byte
P	STOP condition

8.1 Read mode

Application restriction to use the read mode: Read transmissions should not be stopped after read byte 4 (IFBW) since this will disturb level read-out, weak signal processing and bandwidth control. Read transmission can be stopped after any of the other read bytes 0 to 3, 5 or 6.

The read data is loaded into the I²C-bus output register at the ACK clock pulse preceding the data byte.

Table 5. Read register overview

Data byte	Name	Reference
0	IFCOUNTER	Section 8.1.1
1	LEVEL	Section 8.1.2
2	USN/WAM	Section 8.1.3
3	MOD	Section 8.1.4
4	IFBW	Section 8.1.5
5	ID	Section 8.1.6
6	TEMP	Section 8.1.7

8.1.1 Read mode: data byte IFCOUNTER

Table 6. IFCOUNTER - format of data byte 0

7	6	5	4	3	2	1	0
IFCM1	IFCM0	IFCS	IFCA	IFC3	IFC2	IFC1	IFC0

Table 7. IFCOUNTER - data byte 0 bit description

Bit	Symbol	Description
7 and 6	IFCM[1:0]	IF counter mode; IFCM reads 00 immediately after I ² C-bus start of PRESET, SEARCH, AFU, JUMP or CHECK until the first IFC result of the new tuning is available. 00 = no new counter result available (IFC value is previous result or reset state) 01 = new counter result available (IFC value is new result) 10 = counter result from AF update (IFC value is AF result, value is held until I ² C-bus read). Also the detector information of LEV, USN, WAM and MOD shows AF update results. 11 = Power-On Reset (POR) or undefined state of the state machine is detected. The I ² C-bus data is reset to POR state.
5	IFCS	IF counter sign 0 = the IF counter result indicates a positive RF frequency error 1 = the IF counter result indicates a negative RF frequency error
4	IFCA	IF counter accuracy 0 = IF counter result with 1 kHz resolution in FM mode and 0.5 kHz resolution in AM mode 1 = IF counter result with 8 kHz resolution in FM mode and 4 kHz resolution in AM mode
3 to 0	IFC[3:0]	IF counter result; see Table 8

Table 8. IF counter result

IFC3	IFC2	IFC1	IFC0	Deviation from nominal value in FM		Deviation from nominal value in AM	
				IFCA = 0	IFCA = 1	IFCA = 0	IFCA = 1
0	0	0	0	0 kHz to 1 kHz	reset state	0 kHz to 0.5 kHz	reset state
0	0	0	1	1 kHz to 2 kHz	-	0.5 kHz to 1 kHz	-
0	0	1	0	2 kHz to 3 kHz	16 kHz to 24 kHz	1 kHz to 1.5 kHz	8 kHz to 12 kHz
0	0	1	1	3 kHz to 4 kHz	24 kHz to 32 kHz	1.5 kHz to 2 kHz	12 kHz to 16 kHz
0	1	0	0	4 kHz to 5 kHz	32 kHz to 40 kHz	2 kHz to 2.5 kHz	16 kHz to 20 kHz
0	1	0	1	5 kHz to 6 kHz	40 kHz to 48 kHz	2.5 kHz to 3 kHz	20 kHz to 24 kHz
0	1	1	0	6 kHz to 7 kHz	48 kHz to 56 kHz	3 kHz to 3.5 kHz	24 kHz to 28 kHz
0	1	1	1	7 kHz to 8 kHz	56 kHz to 64 kHz	3.5 kHz to 4 kHz	28 kHz to 32 kHz
1	0	0	0	8 kHz to 9 kHz	64 kHz to 72 kHz	4 kHz to 4.5 kHz	32 kHz to 36 kHz
1	0	0	1	9 kHz to 10 kHz	72 kHz to 80 kHz	4.5 kHz to 5 kHz	36 kHz to 40 kHz
1	0	1	0	10 kHz to 11 kHz	80 kHz to 88 kHz	5 kHz to 5.5 kHz	40 kHz to 44 kHz
1	0	1	1	11 kHz to 12 kHz	88 kHz to 96 kHz	5.5 kHz to 6 kHz	44 kHz to 48 kHz
1	1	0	0	12 kHz to 13 kHz	96 kHz to 104 kHz	6 kHz to 6.5 kHz	48 kHz to 52 kHz

Table 8. IF counter result ...continued

IFC3	IFC2	IFC1	IFC0	Deviation from nominal value in FM		Deviation from nominal value in AM	
				IFCA = 0	IFCA = 1	IFCA = 0	IFCA = 1
1	1	0	1	13 kHz to 14 kHz	104 kHz to 112 kHz	6.5 kHz to 7 kHz	52 kHz to 56 kHz
1	1	1	0	14 kHz to 15 kHz	112 kHz to 120 kHz	7 kHz to 7.5 kHz	56 kHz to 60 kHz
1	1	1	1	15 kHz to 16 kHz	≥ 120 kHz	7.5 kHz to 8 kHz	≥ 60 kHz

After a tuning action, which is activated by the state machine, the IF counter is reset at that moment when tuning is established (PLL in-lock). The first counter result is available from 2 ms after reset. For FM further results can be obtained from 4 ms, 8 ms, 16 ms and 32 ms after reset, the increasing count time attenuates influence of FM modulation on the counter result. After this, the counter continues at the maximum count time of 32 ms (see Figure 5). For AM the count time is fixed to 2 ms and results are available every 2 ms.

After AF Update (AFU) sampling the IF counter read value is held (IFCM = 10) (see Figure 6, Figure 17 and Figure 18) for easy I²C-bus read-out. The counter itself remains active in the background in 2 ms count time mode. The IF counter data hold is released after I²C-bus read.

IFCM reads 00 immediately after I²C-bus start of PRESET, SEARCH, AFU, JUMP or CHECK until the first new tuning IFC result is available.

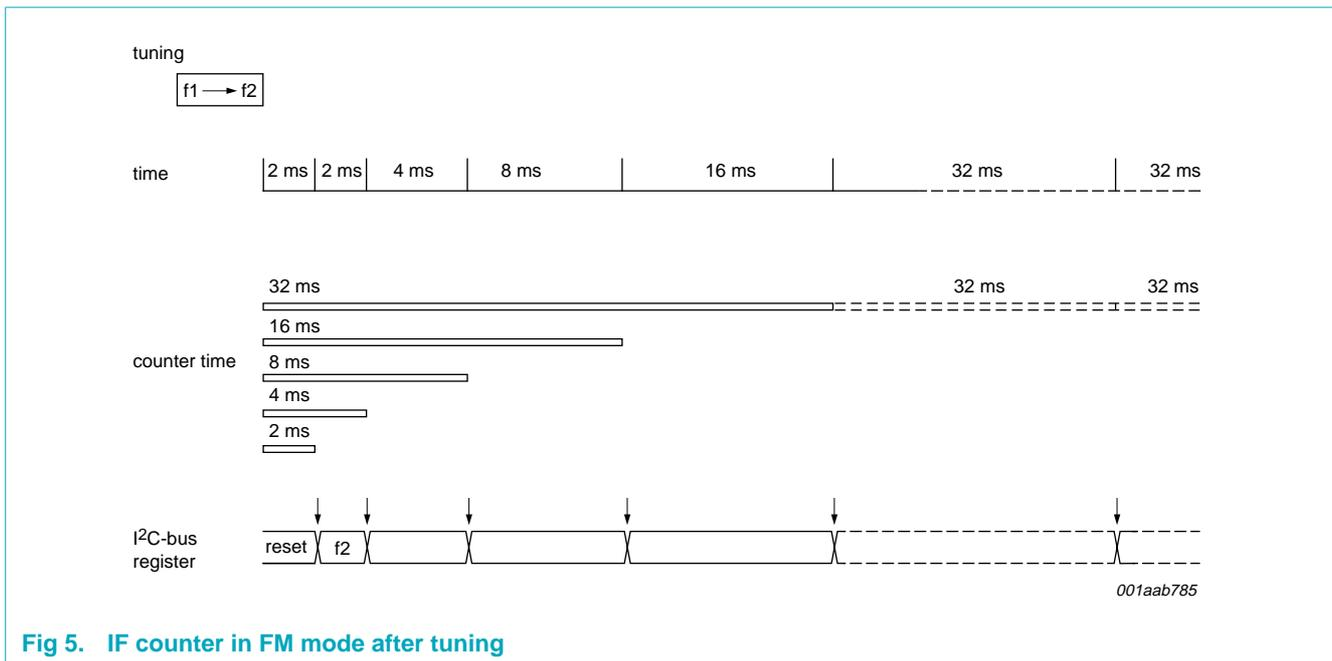

Fig 5. IF counter in FM mode after tuning

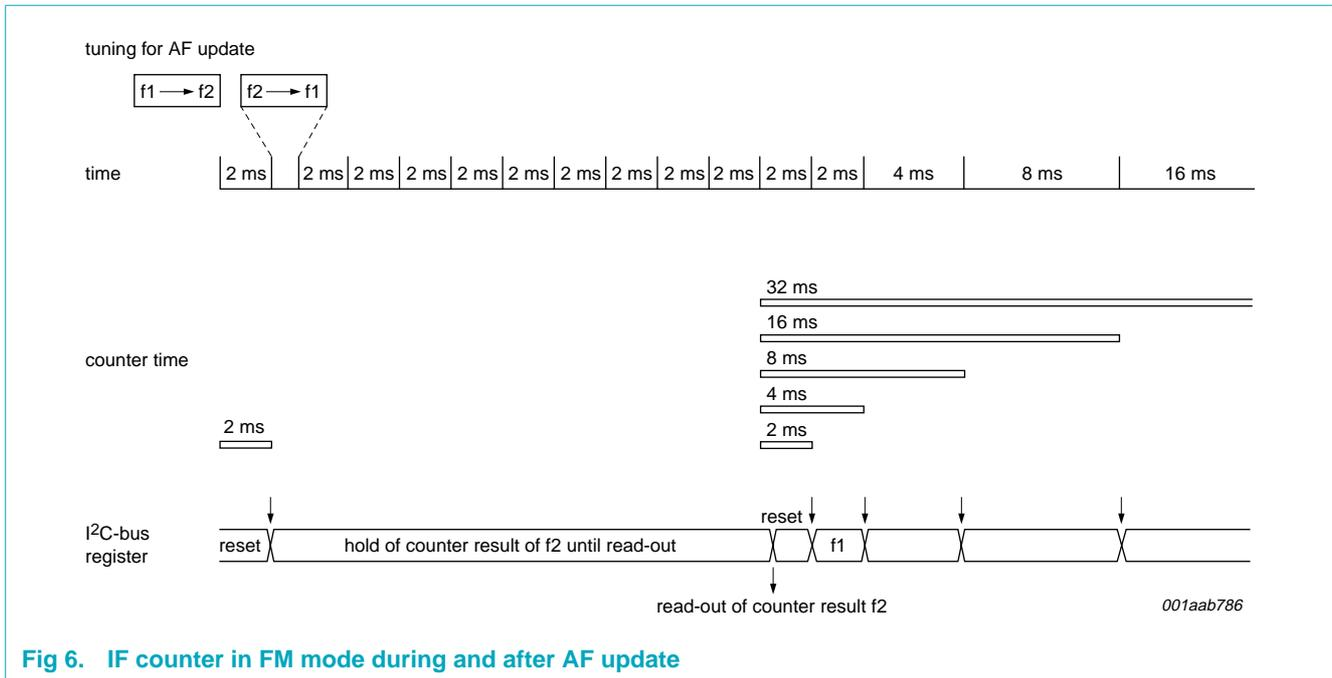

Fig 6. IF counter in FM mode during and after AF update

8.1.2 Read mode: data byte LEVEL

Table 9. LEVEL - format of data byte 1

7	6	5	4	3	2	1	0
LEV7	LEV6	LEV5	LEV4	LEV3	LEV2	LEV1	LEV0

Table 10. LEVEL - data byte 1 bit description

Bit	Symbol	Description
7 to 0	LEV[7:0]	level detector; this byte indicates the LEVEL voltage between 0.25 V (LEV = 0) and 4.25 V (LEV = 255) from the tuner part; $V_{LEVEL} = \frac{1}{64}LEV[7:0] + 0.25 V$; see Figure 7

After AF update sampling the level read value is held (indicated by IFCM = 10) for easy I²C-bus read-out. The level detector remains active in the background. The LEV data hold is released after I²C-bus read.

To reduce the influence of modulation in AM mode the LEV information is additionally filtered by a slow 60 ms detector. Fast level information is made available during AF update and check tuning.

For standard operation the following level alignment (byte LEVELALGN; see [Table 43](#)) is used:

FM and AM level slope; $\Delta LEV = 51$ ($\Delta V_{LEVEL} = 0.80 V$) at $\Delta V_{RF} = 20 dB$ (measured at $V_{RF} = 200 \mu V$ and $V_{RF} = 20 \mu V$)

FM mode level start; LEV = 78 ($V_{LEVEL} = 1.47 V$) at $V_{RF} = 20 \mu V$

AM mode level start; LEV = 63 ($V_{LEVEL} = 1.24 V$) at $V_{RF} = 20 \mu V$

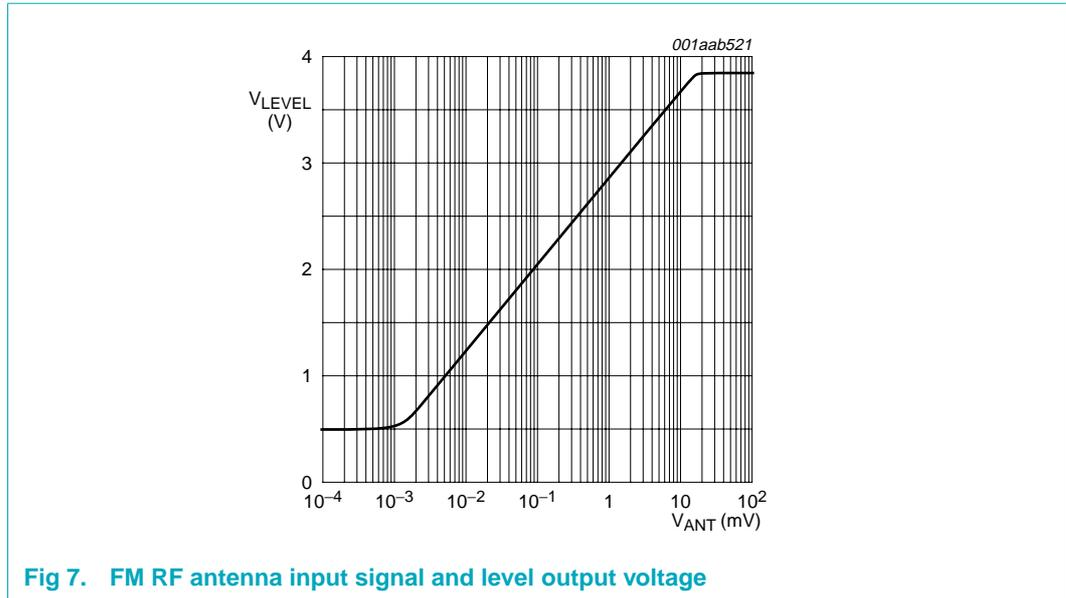

Fig 7. FM RF antenna input signal and level output voltage

8.1.3 Read mode: data byte USN/WAM

Table 11. USN/WAM - format of data byte 2

7	6	5	4	3	2	1	0
USN3	USN2	USN1	USN0	WAM3	WAM2	WAM1	WAM0

Table 12. USN/WAM - data byte 2 bit description

Bit	Symbol	Description
7 to 4	USN[3:0]	ultrasonic noise detector; this value indicates the USN content of the MPX audio signal; see Figure 24
3 to 0	WAM[3:0]	wideband AM detector; this value indicates the WAM content of the LEVEL voltage; see Figure 24

After AF update sampling the USN and WAM read value is held (indicated by IFCM = 10) for easy I²C-bus read-out. The USN and WAM detectors remain active in the background. The USN and WAM data hold is released after I²C-bus read.

8.1.4 Read mode: data byte MOD

Table 13. MOD - format of data byte 3

7	6	5	4	3	2	1	0
MOD4	MOD3	MOD2	MOD1	MOD0	STIN	TAS1	TAS0

Table 14. MOD - data byte 3 bit description

Bit	Symbol	Description
7 to 3	MOD[4:0]	<p>modulation detector; this value indicates the audio modulation; see Table 15</p> <p>FM between 0 kHz and 150 kHz FM deviation</p> <p>AM between 0 % and 200 % modulation</p> <p>FM offset detector; a read value of 31 indicates offset detection. The offset detector is part of the FM bandwidth control algorithm and detects adjacent channel breakthrough.</p> <p>VU-meter; when an external audio source is selected and VU-meter read is active (see subaddress 17h; see Table 97) MOD indicates the audio input level (RMS) between 0 V and 2 V; see Table 15.</p>
2	STIN	<p>stereo indicator; this bit indicates if a stereo pilot signal has been detected</p> <p>0 = no pilot signal detected</p> <p>1 = pilot signal is detected and the FM stereo decoder is activated</p>
1 and 0	TAS[1:0]	<p>Tuning action state; state machine information. The signal TAS informs about internal control functions of the tuner action state machine. This way the progress of tuner actions can be monitored by the microcontroller.</p> <p>00 = inactive</p> <p>01 = starting mute</p> <p>10 = PLL tuning</p> <p>11 = tuning ready with mute active</p>

Table 15. MOD detector

MOD4	MOD3	MOD2	MOD1	MOD0	FM radio Δf	AM radio m	VU	External source
0	0	0	0	0	< 1.5 kHz	< 2 %	-	< 0.02 V
0	0	0	0	1	1.5 kHz	2 %	-34 dB	0.02 V
0	0	0	1	0	3 kHz	4 %	-28 dB	0.04 V
0	0	0	1	1	4.5 kHz	6 %	-24 dB	0.06 V
0	0	1	0	0	6 kHz	8 %	-22 dB	0.08 V
0	0	1	0	1	7.5 kHz	10 %	-20 dB	0.1 V
0	0	1	1	0	9.5 kHz	13 %	-18 dB	0.13 V
0	0	1	1	1	12 kHz	16 %	-16 dB	0.16 V
0	1	0	0	0	15 kHz	20 %	-14 dB	0.2 V
0	1	0	0	1	19 kHz	25 %	-12 dB	0.25 V
0	1	0	1	0	24 kHz	32 %	-10 dB	0.32 V
0	1	0	1	1	30 kHz	40 %	-8 dB	0.4 V
0	1	1	0	0	38 kHz	50 %	-6 dB	0.5 V

Table 15. MOD detector ...continued

MOD4	MOD3	MOD2	MOD1	MOD0	FM radio Δf	AM radio m	VU	External source
0	1	1	0	1	47 kHz	63 %	-4 dB	0.63 V
0	1	1	1	0	60 kHz	80 %	-2 dB	0.8 V
0	1	1	1	1	75 kHz	100 %	0 dB	1 V
1	0	0	0	0	95 kHz	125 %	2 dB	1.25 V
1	0	0	0	1	120 kHz	160 %	4 dB	1.6 V
1	0	0	1	0	150 kHz	200 %	6 dB	2 V
1	0	0	1	1	-	-	-	-
:	:	:	:	:	:	:	:	:
1	1	1	1	0	-	-	-	-
1	1	1	1	1	OFFS detection	-	-	-

The indicated amplitude levels are approximate values.

In case of FM radio carrier modulation is measured (MPX FM deviation). Timing is fixed with fast 30 ms release time. Depending upon reception conditions and internal offsets small modulation levels may be indicated as 0. After AF update sampling the MOD read value is held (indicated by IFCM = 10) for easy I²C-bus read-out. The MOD detector remains active in the background. The MOD data hold is released after I²C-bus read.

In case of AM radio carrier modulation is measured (AM). Timing is fixed with fast 30 ms release time. Modulation may exceed 100 % in case of special modulation schemes as used by some stations. After AF update sampling the MOD read value is held (indicated by IFCM = 10) for easy I²C-bus read-out. The MOD detector remains active in the background. The MOD data hold is released after I²C-bus read.

With external source selection and VU-meter mode disabled (AVUM = 0 and COMP = 0) FM or AM modulation is indicated equal to radio mode.

With external source selection and VU-meter mode enabled (AVUM = 1 or COMP = 1) the audio input level of the external source is indicated (i.e. the audio level as found on the line input pins). For stereo signals left and right channel are combined for MOD read ($0.5 \times L + 0.5 \times R$). VU-meter timing is defined by setting HCT. For AVUM control see subaddress 17h; see [Table 97](#). In case of AF update sampling the AM or FM modulation value is indicated with data hold (indicated by IFCM = 10) for easy I²C-bus read-out. The MOD data hold is released after I²C-bus read and VU-meter indication continues.

8.1.5 Read mode: data byte IFBW

Table 16. IFBW - format of data byte 4

7	6	5	4	3	2	1	0
RAGC1	RAGC0	ASIA	IFBW4	IFBW3	IFBW2	IFBW1	IFBW0

Table 17. IFBW - data byte 4 bit description

Bit	Symbol	Description
7 and 6	RAGC[1:0]	RF AGC indicator; PIN diode current on pins IAMAGC or IFMAGC 00 = FM: < 0.05 mA AM: < 0.1 mA 01 = FM: 0.05 mA to 0.5 mA AM: 0.1 mA to 0.5 mA 10 = 0.5 mA to 2.5 mA 11 = > 2.5 mA
5	ASIA	ASI active; this bit indicates activity of the audio step interpolation function 0 = ASI is not active 1 = ASI step is in progress
4 to 0	IFBW[4:0]	FM IF filter bandwidth control; 57 kHz (0 0000) to 165 kHz (1 1111). The bandwidth read data equals the write data definition (at DYN = 0; see Table 28).

8.1.6 Read mode: data byte ID

Table 18. ID - format of data byte 5

7	6	5	4	3	2	1	0
IFCAPG	-	-	-	-	ID2	ID1	ID0

Table 19. ID - data byte 5 bit description

Bit	Symbol	Description
7	IFCAPG	IF filter gear; read value is used for IFCAP adjustment (byte IFCAP); see Table 47
6 to 3	-	reserved
2 to 0	ID[2:0]	device type identification 000 = TEF6901A

8.1.7 Read mode: data byte TEMP

Table 20. TEMP - format of data byte 6

7	6	5	4	3	2	1	0
TEMP7	TEMP6	TEMP5	TEMP4	TEMP3	TEMP2	TEMP1	TEMP0

Table 21. TEMP - data byte 6 bit description

Bit	Symbol	Description
7 to 0	TEMP[7:0]	on-chip temperature; 1 step \approx 1 K; relative indication

8.2 Write mode

The device is controlled by the I²C-bus. After the Integrated Circuit (IC) address the MSA byte contains the control of the tuning action via the bits MODE[2:0] and subaddressing via bits SA[4:0] (see [Figure 8](#)).

All circuits are controlled by the CONTROL register. Any data change in the CONTROL register has immediate effect and will change the operation of the circuit accordingly. The subaddress range 00h to 05h includes data that may lead to audible disturbance when changed. Therefore the subaddress range 00h to 05h is not loaded in the CONTROL register directly but loaded in a BUFFER register instead. This allows the IC to take care of tuning actions and mute control, freeing the microcontroller from cumbersome controls and timings. The subaddress range of 06h onwards does not contain such critical data. I²C-bus information in this range will be loaded in the CONTROL register directly (at acknowledge of each byte).

Controlled by a state machine the BUFFER data will be loaded in the CONTROL register for new settings. However at the same time the CONTROL data is loaded in the BUFFER register. This register swap action allows a fast return to the previous setting because the previous data remains available in the BUFFER register (see [Figure 9](#)).

Via MODE several operational modes can be selected for the state machine. MODE offers all standard tuning actions as well as generic control for flexibility. The state machine controls the tuner directly by controlling the I²C-bus data. Internal circuits like the IF counter, mute and weak signal processing are controlled complementary to the tuner action. The state machine operation starts at the end of transmission (P = STOP). In case a previous action is still active this is overruled and the new action defined by MODE is started immediately.

When only the address byte is transmitted no action is started and no setting is changed, this can be used to test the presence of the device on the bus. To minimize the I²C-bus transmission time only bytes that include data changes need to be written. Following the MSA byte the transmission can start at any given data byte defined by the subaddress (SA) bits. In case of MODE = preset, search or load the value of buffered data that is not overwritten by the new transmission will equal the control register content, i.e. the current tuner state. Instead in case of MODE = buffer, AF update, jump, check or end any not overwritten BUFFER data remains to be the existing BUFFER register content, i.e. the previous tuner state.

After power-on reset all registers, including the reserved registers, should be initialized with their default settings (see [Table 22](#)) using a preset mode tuning action (see [Table 25](#)). The tuning mute circuit is muted. An action of the state machine is required to de-mute the circuit, for this purpose preset mode (bits MODE[2:0] = 001) is best fitted since it assures fast settling of all parameters before mute is released.

Table 22. Write mode subaddress overview

Subaddress	Name	Default	Reference
00h	BANDWIDTH	1111 1110	Section 8.2.2
01h	PLLM	0000 1000	Section 8.2.3
02h	PLLL	0111 1110	Section 8.2.3
03h	DAA	0100 0000	Section 8.2.4
04h	AGC	0000 0000	Section 8.2.5
05h	BAND	0010 0000	Section 8.2.6
06h	LEVELALGN	1000 0100	Section 8.2.8
07h	IFCF	0010 0000	Section 8.2.9
08h	IFCAP	0000 1000	Section 8.2.10
09h	ACD	0100 1010	Section 8.2.11
0Ah	SENSE	1000 0101	Section 8.2.12
0Bh	TIMING	0110 0110	Section 8.2.13
0Ch	SNC	0111 0100	Section 8.2.14
0Dh	HIGHCUT	0110 1111	Section 8.2.15
0Eh	SOFTMUTE	0110 1010	Section 8.2.16
0Fh	RADIO	0001 1010	Section 8.2.17
10h	INPUT	0000 1010	Section 8.2.18
11h	VOLUME	0011 0000	Section 8.2.19
12h	TREBLE	0000 1100	Section 8.2.20
13h	BASS	0000 1100	Section 8.2.21
14h	FADER	0000 0000	Section 8.2.22
15h	OUTPUT	0000 1111	Section 8.2.23
16h	BALANCE	1000 0000	Section 8.2.24
17h	LOUDNESS	0000 1100	Section 8.2.25
18h	POWER	0000 0110	Section 8.2.26
19h to 1Eh	reserved	0000 0000	Section 8.2.27
1Fh	TEST	0000 0000	Section 8.2.28

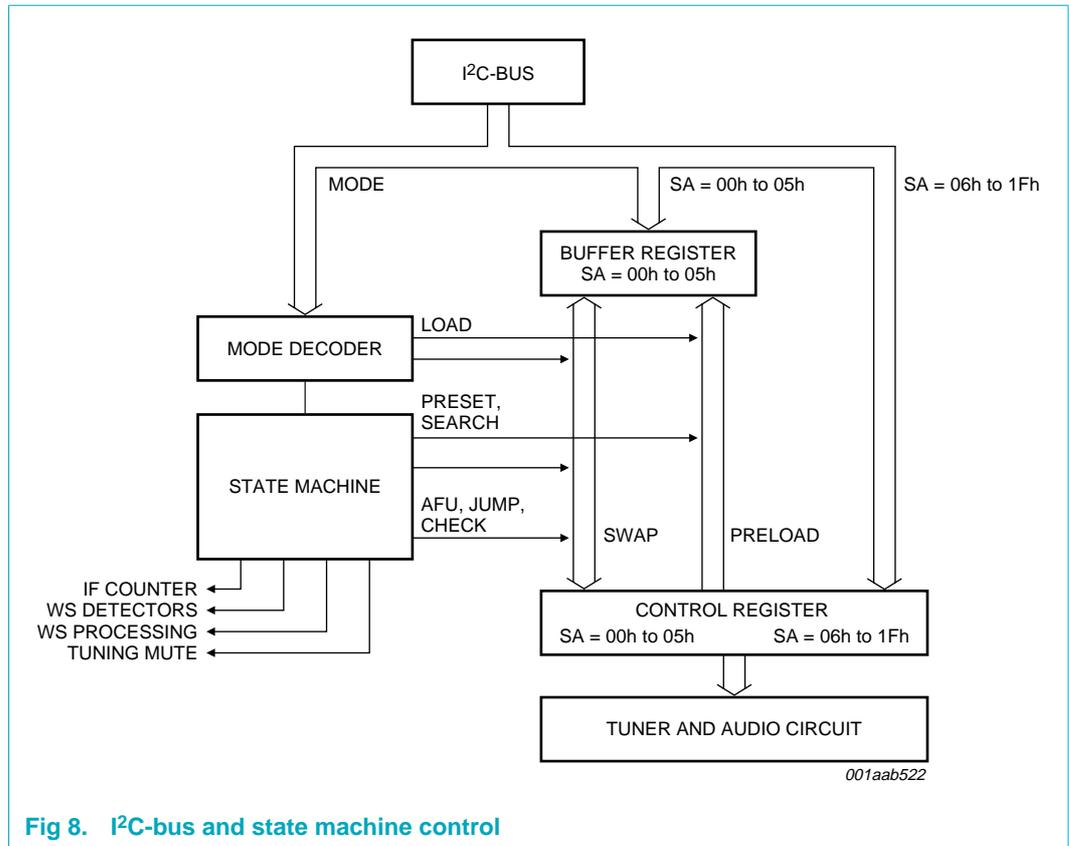

Fig 8. I²C-bus and state machine control

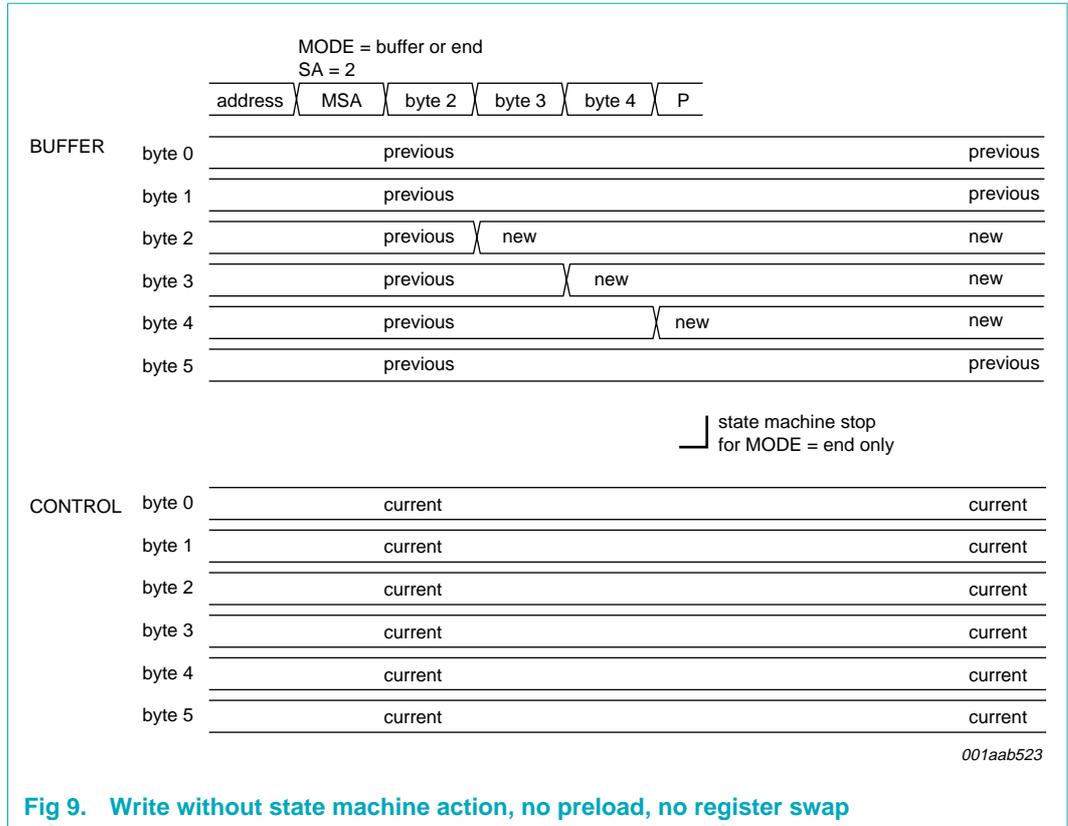

Fig 9. Write without state machine action, no preload, no register swap

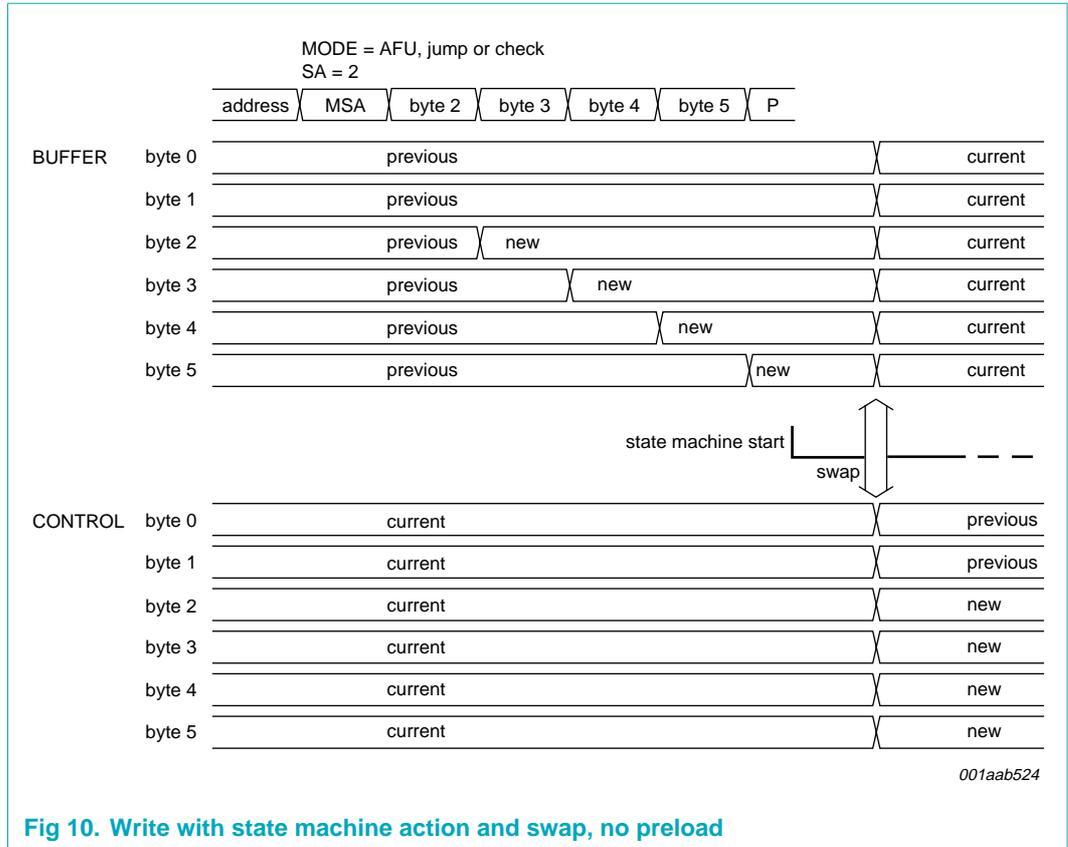

Fig 10. Write with state machine action and swap, no preload

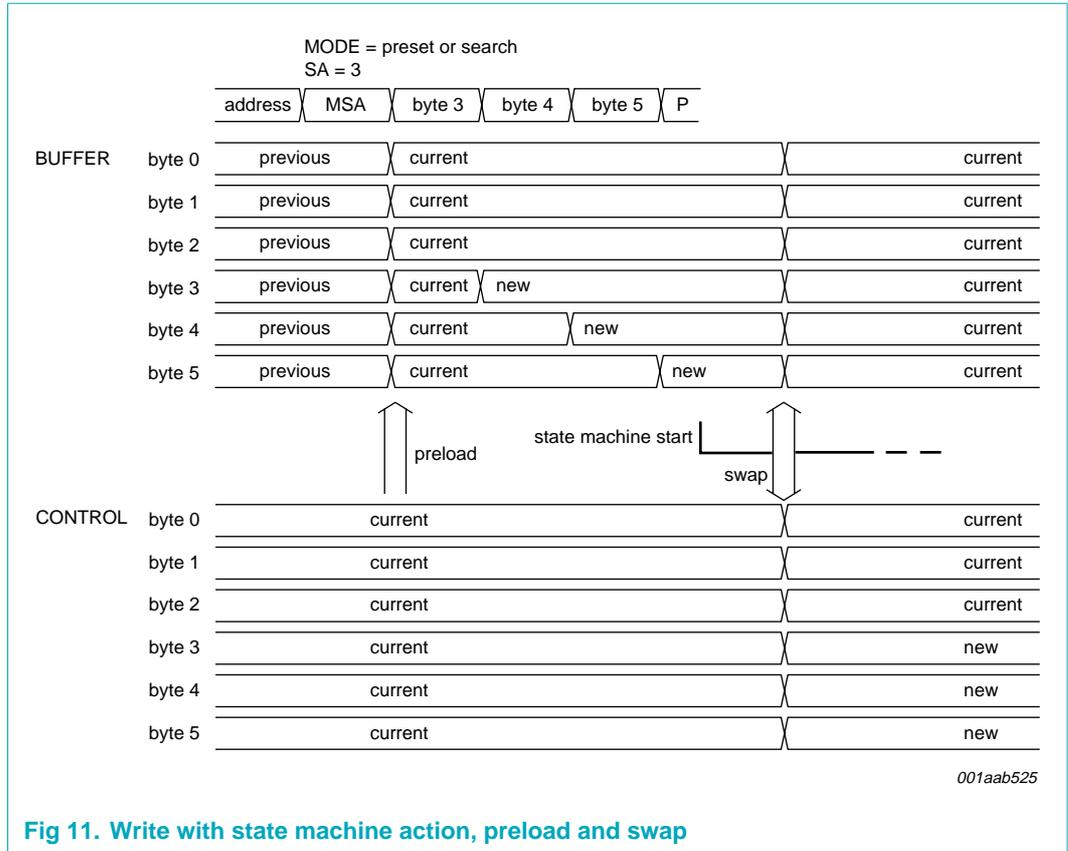

Fig 11. Write with state machine action, preload and swap

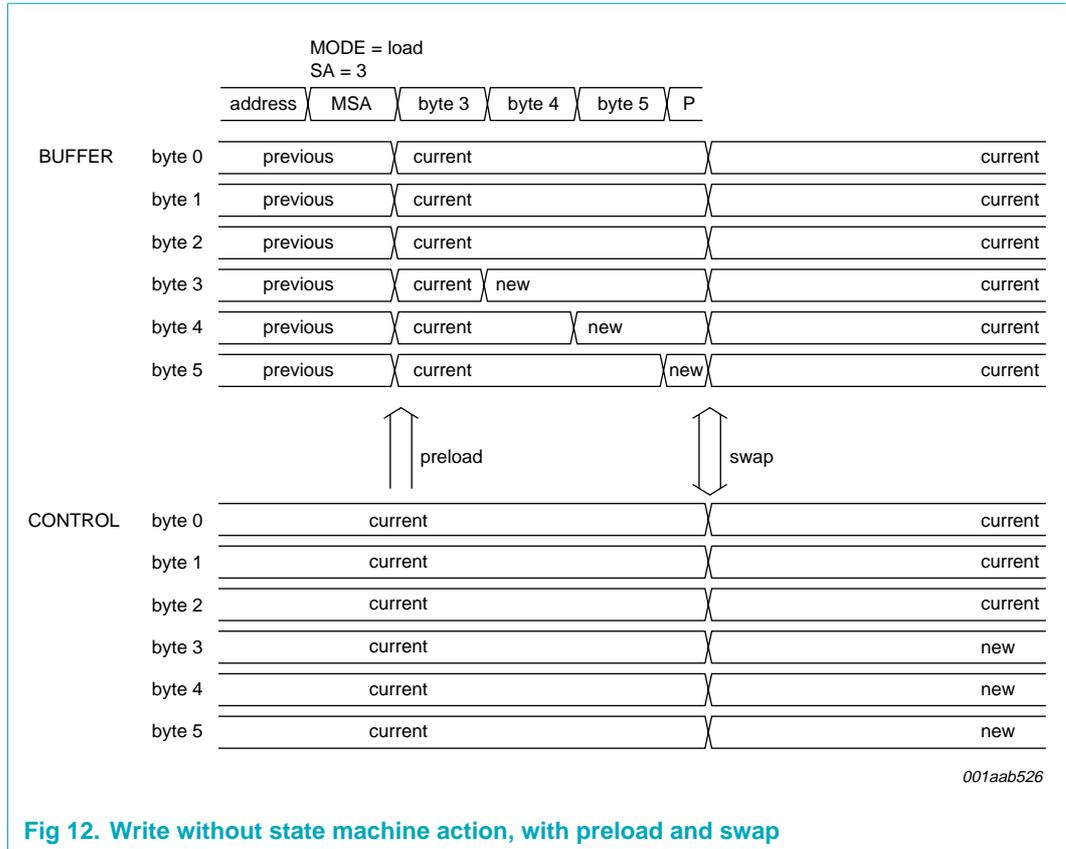

Fig 12. Write without state machine action, with preload and swap

8.2.1 Mode and subaddress byte for write

Table 23. MSA - format of mode and subaddress byte

7	6	5	4	3	2	1	0
MODE2	MODE1	MODE0	SA4	SA3	SA2	SA1	SA0

Table 24. MSA - mode and subaddress byte bit description

Bit	Symbol	Description
7 to 5	MODE[2:0]	mode tuning action; see Table 25
4 to 0	SA[4:0]	Subaddress; 0 0000 to 1 1111 = write data byte subaddress 00h to 1Fh. The subaddress value is auto-incremented and will revert from SA = 1Fh to SA = 00h. The auto-increment function cannot be disabled.

Table 25. Tuning action modes

MODE2	MODE1	MODE0	Symbol	Description
0	0	0	buffer	write BUFFER register, no state machine action, no register swap; see Figure 9
0	0	1	preset	tune to new program with 60 ms mute control; swap; see Figure 13 and Figure 14 ; BUFFER is preloaded with CONTROL register; immediate swap; see Figure 11
0	1	0	search	tune to new program and stay muted (to release use end); swap; see Figure 15 and Figure 16 ; BUFFER is preloaded with CONTROL register; see Figure 11
0	1	1	AF update	tune to AF program; check AF quality and tune back to main program; two register swap operations; see Figure 17 and Figure 18
1	0	0	jump	tune to AF program in minimum time; register swap; see Figure 19 and Figure 20
1	0	1	check	tune to AF program and stay muted (to release use end); register swap; see Figure 21 and Figure 22
1	1	0	load	write CONTROL register via BUFFER; no state machine action; BUFFER is preloaded with CONTROL register; immediate swap; see Figure 12
1	1	1	end	end action; release mute; no register swap; see Figure 9 and Figure 23

Since buffer mode (bits MODE[2:0] = 000) does not change any tuner action or register other than those defined by the I²C-bus write transmission it generally is the mode used for writing outside the buffered subaddress range (i.e. bits SA[4:0] = 06h to 1Fh). Writing in the subaddress range of 06h to 1Fh is executed immediately and is not controlled by the state machine. Load mode does not interrupt a state machine process, the preload action changes the content of the BUFFER register which may interfere with a tuner action in progress.

When a new state machine tuning action is started during a mute state of the state machine, the new action skips the unnecessary activation of mute and starts immediately with the actions that follow the mute period in the standard sequence. In this way fastest timing is possible e.g. for search tuning (see [Figure 14](#), [Figure 16](#), [Figure 20](#) and [Figure 22](#)). When AF update mode is started during a mute state only the return tuning action will be performed; in combination with check mode an AF update can be created with the AF sampling time defined by I²C-bus control (see [Figure 18](#)).

The FM IF2 signal path contains a digital controlled AGC function with a maximum AGC decay time of 13 ms to realize sufficient AM suppression during changing signal conditions and high modulation situations. During the settling of the AGC (e.g. after a tuning action), the gain of the FM path and the level detection can be affected. To get correct signal quality information, a minimum time of 13 ms should be used between two tuning actions.

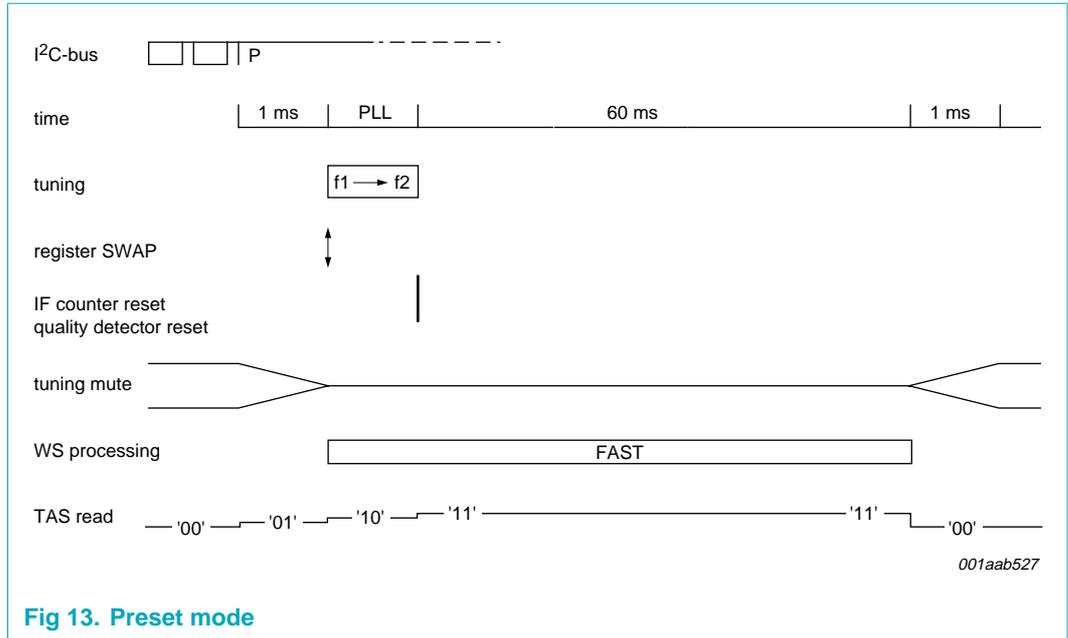

Fig 13. Preset mode

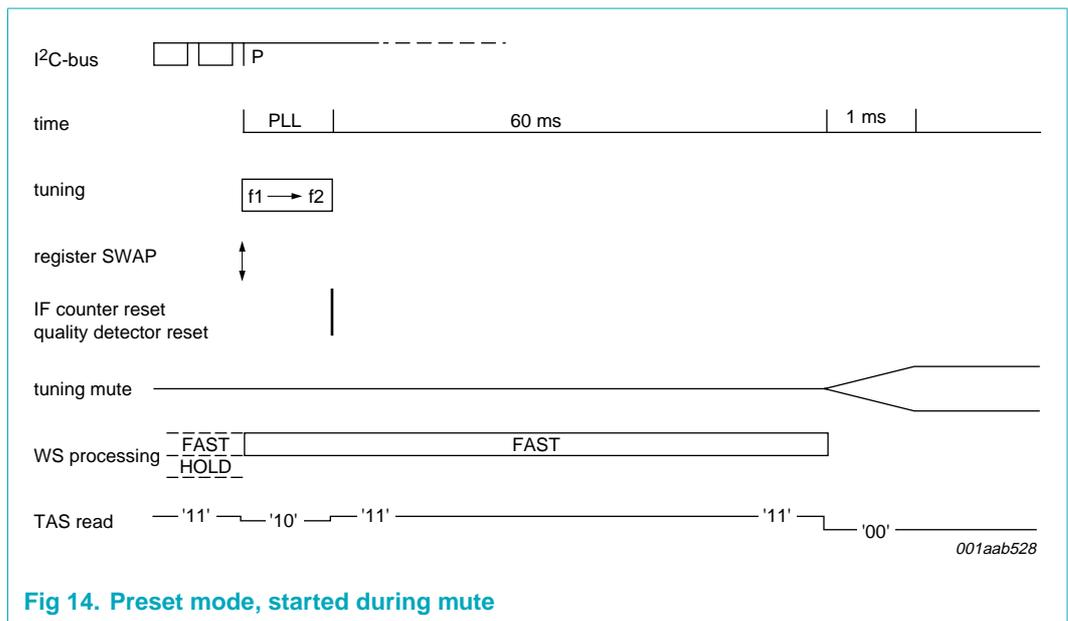

Fig 14. Preset mode, started during mute

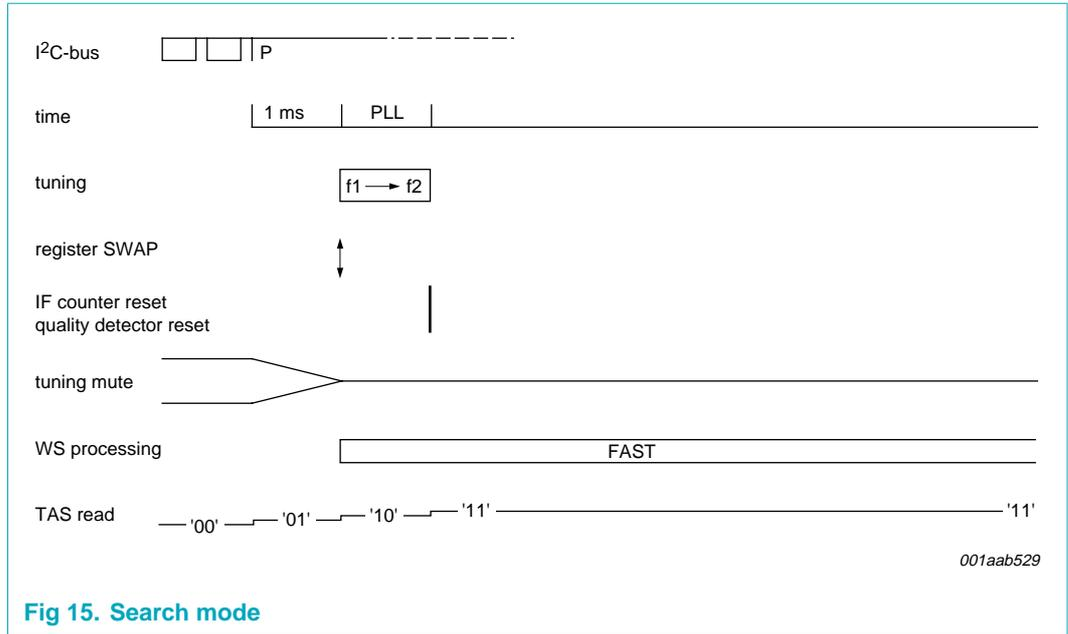

Fig 15. Search mode

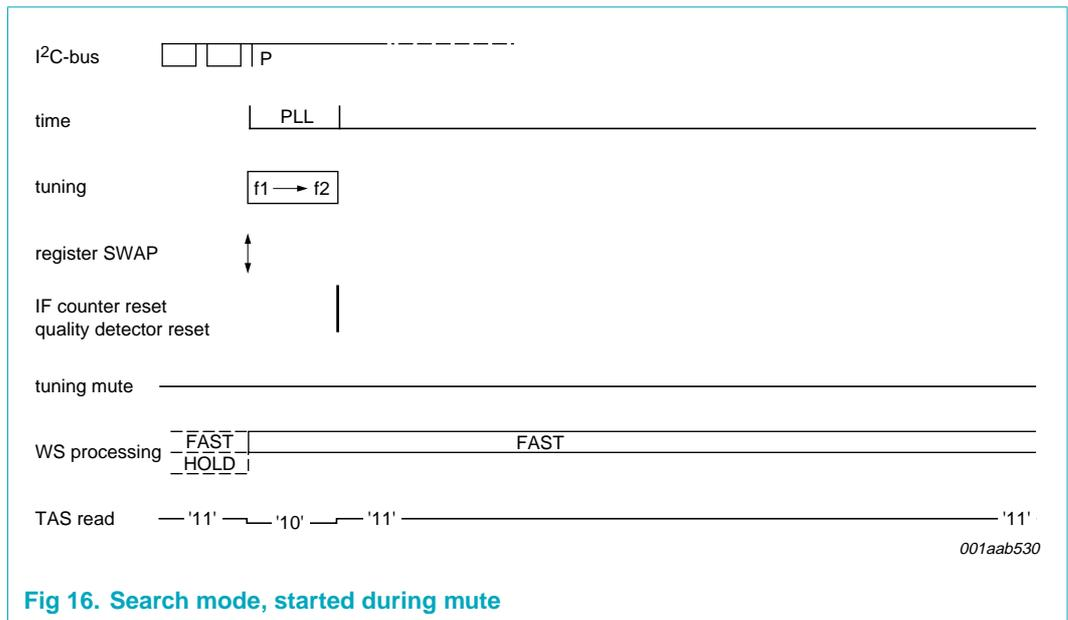

Fig 16. Search mode, started during mute

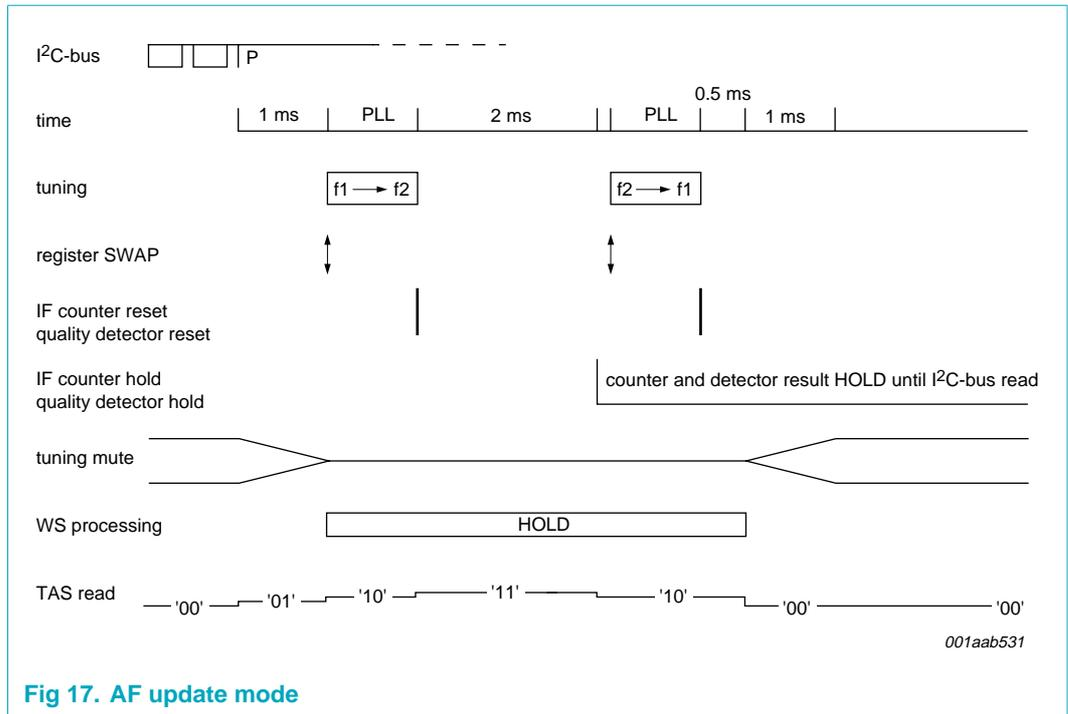

Fig 17. AF update mode

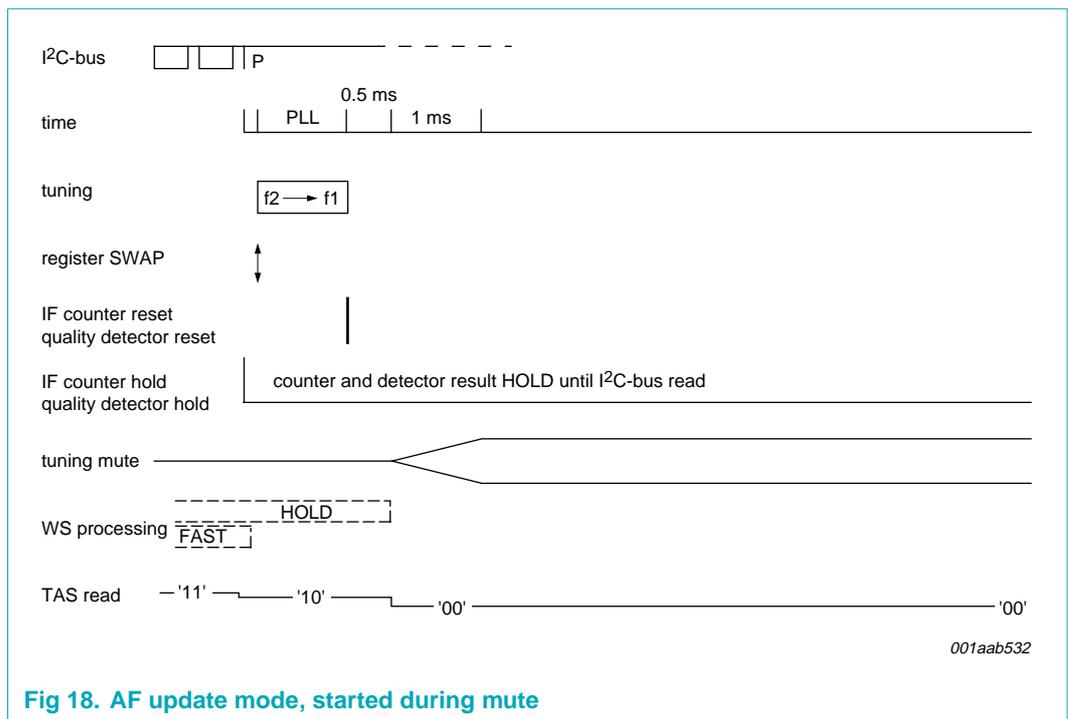
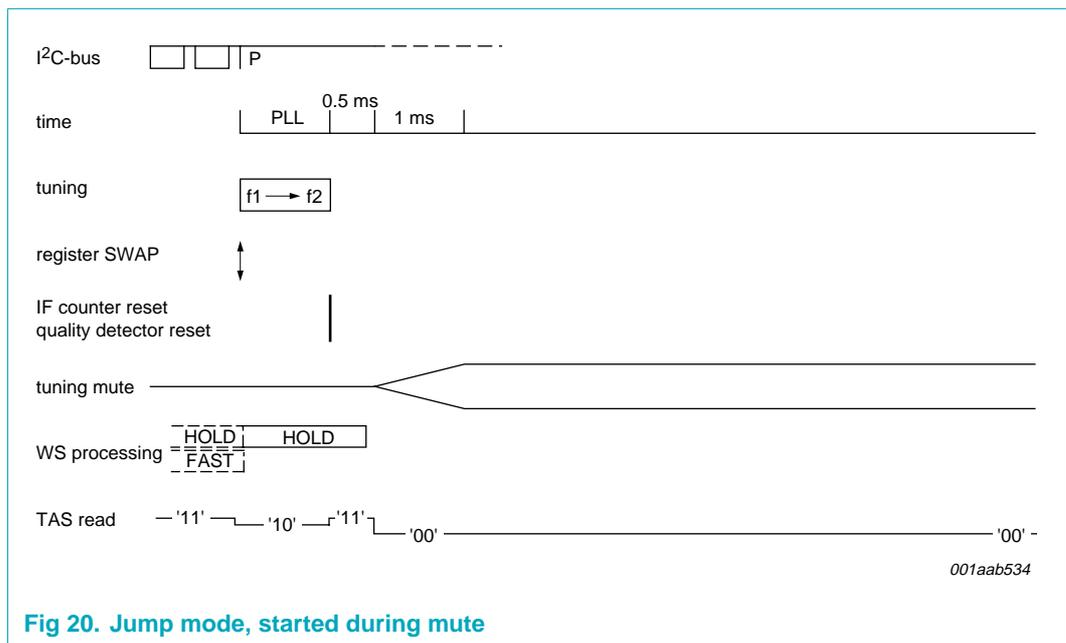
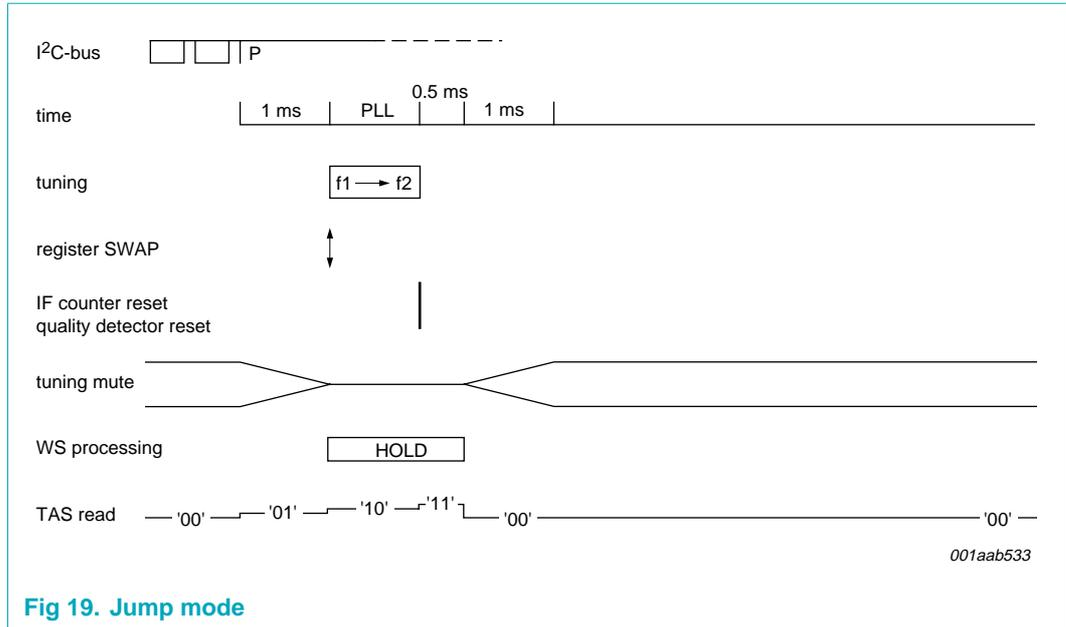
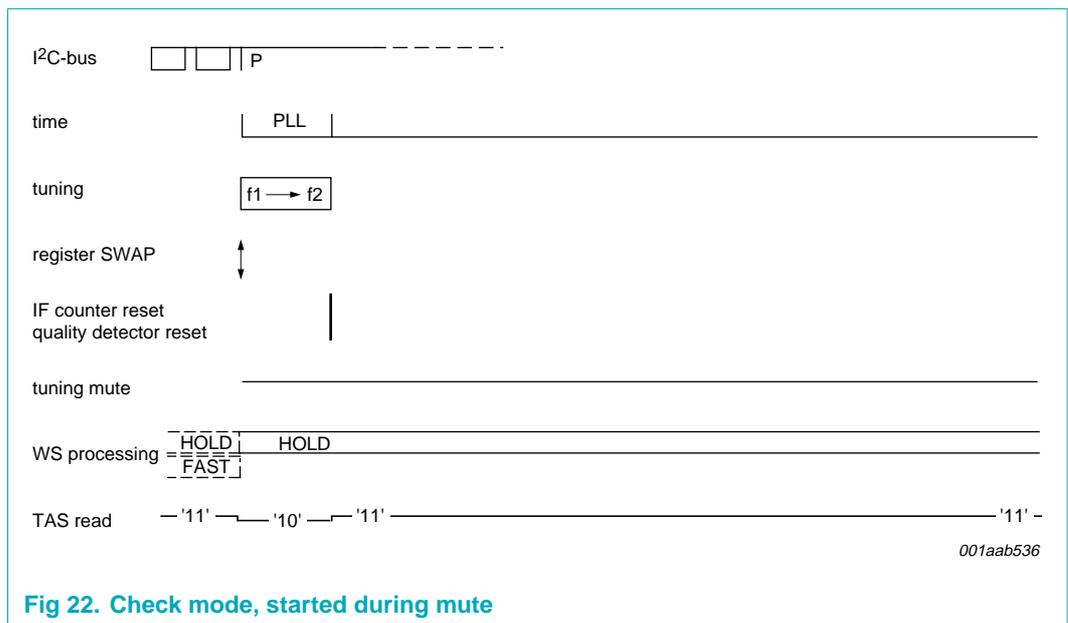
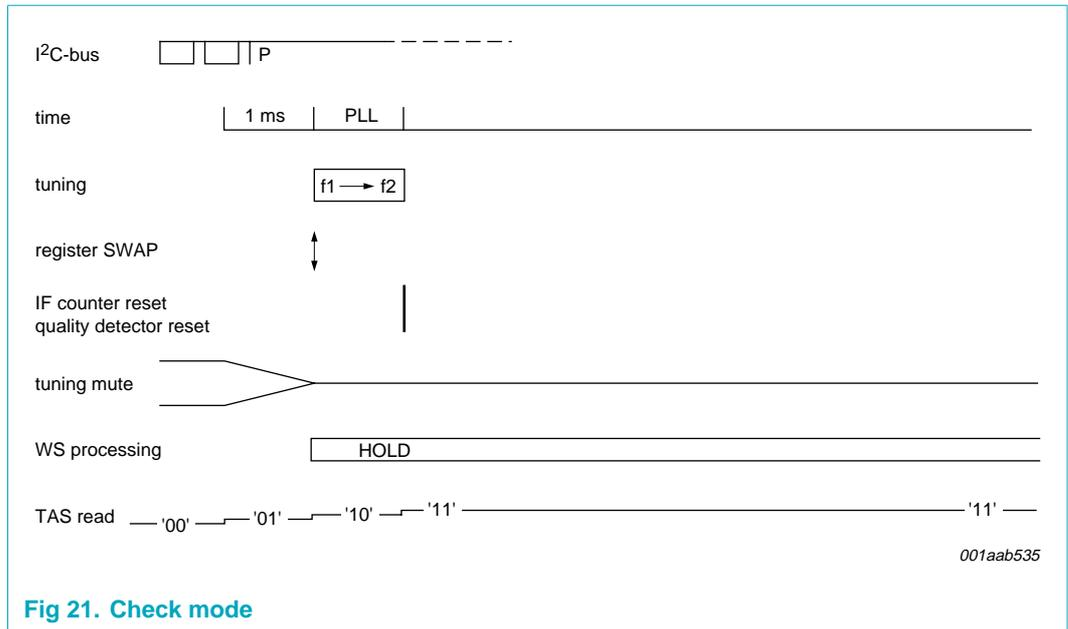

Fig 18. AF update mode, started during mute





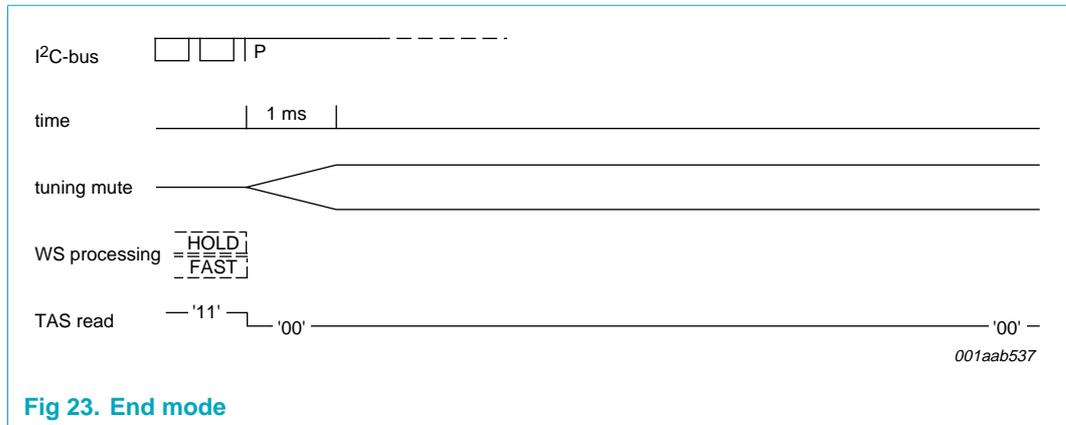

Fig 23. End mode

8.2.2 Write mode: data byte BANDWIDTH

Table 26. BANDWIDTH - format of data byte 00h with default setting (buffered)

7	6	5	4	3	2	1	0
DYN	BW4	BW3	BW2	BW1	BW0	TE1	TE0
1	1	1	1	1	1	1	0

Table 27. BANDWIDTH - data byte 00h bit description

Bit	Symbol	Description
7	DYN	dynamic bandwidth; see Table 28 0 = FM IF bandwidth set by BW 1 = FM IF bandwidth dynamically controlled
6 to 2	BW[4:0]	FM IF bandwidth; see Table 28 DYN = 0 00h to 1Fh = FM fixed IF bandwidth 57 kHz to 165 kHz DYN = 1 00h to 0Fh = minimum dynamic bandwidth 57 kHz to 109 kHz 10h to 1Fh = maximum dynamic bandwidth 113 kHz to 165 kHz
1 and 0	TE[1:0]	threshold extension 00 = no threshold extension 01 = threshold extension low 10 = threshold extension standard 11 = threshold extension high

Table 28. FM IF bandwidth selection

BW4	BW3	BW2	BW1	BW0	DYN = 0	DYN = 1
0	0	0	0	0	57 kHz	57 kHz to 165 kHz
0	0	0	0	1	60 kHz	60 kHz to 165 kHz
0	0	0	1	0	64 kHz	64 kHz to 165 kHz
0	0	0	1	1	67 kHz	67 kHz to 165 kHz
0	0	1	0	0	71 kHz	71 kHz to 165 kHz
0	0	1	0	1	74 kHz	74 kHz to 165 kHz
0	0	1	1	0	78 kHz	78 kHz to 165 kHz
0	0	1	1	1	81 kHz	81 kHz to 165 kHz
0	1	0	0	0	85 kHz	85 kHz to 165 kHz
0	1	0	0	1	88 kHz	88 kHz to 165 kHz
0	1	0	1	0	92 kHz	92 kHz to 165 kHz
0	1	0	1	1	95 kHz	95 kHz to 165 kHz
0	1	1	0	0	99 kHz	99 kHz to 165 kHz
0	1	1	0	1	102 kHz	102 kHz to 165 kHz
0	1	1	1	0	106 kHz	106 kHz to 165 kHz
0	1	1	1	1	109 kHz	109 kHz to 165 kHz
1	0	0	0	0	113 kHz	57 kHz to 113 kHz
1	0	0	0	1	116 kHz	57 kHz to 116 kHz
1	0	0	1	0	120 kHz	57 kHz to 120 kHz
1	0	0	1	1	123 kHz	57 kHz to 123 kHz
1	0	1	0	0	127 kHz	57 kHz to 127 kHz
1	0	1	0	1	130 kHz	57 kHz to 130 kHz
1	0	1	1	0	134 kHz	57 kHz to 134 kHz
1	0	1	1	1	137 kHz	57 kHz to 137 kHz
1	1	0	0	0	141 kHz	57 kHz to 141 kHz
1	1	0	0	1	144 kHz	57 kHz to 144 kHz
1	1	0	1	0	148 kHz	57 kHz to 148 kHz
1	1	0	1	1	151 kHz	57 kHz to 151 kHz
1	1	1	0	0	155 kHz	57 kHz to 155 kHz
1	1	1	0	1	158 kHz	57 kHz to 158 kHz
1	1	1	1	0	162 kHz	57 kHz to 162 kHz
1	1	1	1	1	165 kHz	57 kHz to 165 kHz

8.2.3 Write mode: data bytes PLLM and PLLL

Table 29. PLLM - format of data byte 01h with default setting (buffered)

7	6	5	4	3	2	1	0
RFGAIN	PLL14	PLL13	PLL12	PLL11	PLL10	PLL9	PLL8
0	0	0	0	1	0	0	0

Table 30. PLLL - format of data byte 02h with default setting (buffered)

7	6	5	4	3	2	1	0
PLL7	PLL6	PLL5	PLL4	PLL3	PLL2	PLL1	PLL0
0	1	1	1	1	1	1	0

Table 31. PLLM and PLLL - data byte 01h and data byte 02h bit description

Bit	Symbol	Description
7 (PLL M)	RFGAIN	RF gain setting in FM mode 0 = standard RF gain 1 = +6 dB additional RF gain at FM mixer 1
6 to 0 (PLL M) 7 to 0 (PLL L)	PLL[14:0]	VCO programmable divider N; application range of N = 1024 to 32767; see Section 8.2.7

8.2.4 Write mode: data byte DAA

Table 32. DAA - format of data byte 03h with default setting (buffered)

7	6	5	4	3	2	1	0
0	DAA6	DAA5	DAA4	DAA3	DAA2	DAA1	DAA0
	1	0	0	0	0	0	0

Table 33. DAA - data byte 03h bit description

Bit	Symbol	Description
7	-	reserved; 0 = normal operation
6 to 0	DAA[6:0]	RF selectivity alignment FM: alignment of antenna circuit tuning voltage ($0.1 \times V_{VCO}$ to $2.0 \times V_{VCO}$) AM: voltage Digital-to-Analog Converter (DAC) output (0.1×4.3 V to 2.0×4.3 V)

8.2.5 Write mode: data byte AGC

Table 34. AGC - format of data byte 04h with default setting (buffered)

7	6	5	4	3	2	1	0
AGCSW	IFGAIN	0	0	AGC1	AGC0	KAGC	LODX
0	0			0	0	0	0

Table 35. AGC - data byte 04h bit description

Bit	Symbol	Description
7	AGCSW	RF AGC switch 0 = no control of unused RF AGC 1 = unused AM RF AGC PIN diode at FM mode, or unused FM RF AGC PIN diode at AM mode is supplied with a constant current for fixed attenuation
6	IFGAIN	IF gain 0 = IF gain for low loss 10.7 MHz filter 1 = increased IF gain (3 dB) for high loss 10.7 MHz filter
5 and 4	-	reserved; 0 = normal operation
3 and 2	AGC[1:0]	setting of RF AGC threshold voltage FM mixer 1 input voltage (RMS value) 00 = 24 mV 01 = 17 mV 10 = 12 mV 11 = 9 mV AM mixer 1 input voltage (peak-to-peak value) 00 = 1000 mV 01 = 700 mV 10 = 500 mV 11 = 350 mV
1	KAGC	keyed AGC FM mode 0 = keyed AGC off 1 = keyed AGC on; the AGC start level is shifted to a value 10 dB above the standard AGC start level, when the level voltage of the wanted RF signal is below the threshold level voltage for narrow-band AGC AM mode 0 = RF cascode AGC enabled with full range 1 = RF cascode AGC enabled with limited range
0	LODX	FM: local switch 0 = standard operation (DX) 1 = forced FM RF AGC attenuation (LOCAL) AM: trigger signal from AM IF noise blanker to AM audio noise blanker 0 = trigger signal active for low modulation ($m < 0.05$) only 1 = trigger signal always active, independent of modulation

8.2.6 Write mode: data byte BAND

Table 36. BAND - format of data byte 05h with default setting (buffered)

7	6	5	4	3	2	1	0
BAND2	BAND1	BAND0	FREF2	FREF1	FREF0	LOINJ	0
0	0	1	0	0	0	0	

Table 37. BAND - data byte 05h bit description

Bit	Symbol	Description
7 to 5	BAND[2:0]	FM and AM band selection; see Table 38
4 to 2	FREF[2:0]	PLL reference frequency; see Table 39
1	LOINJ	FM mixer 1 image suppression 0 = high injection image suppression 1 = low injection image suppression
0	-	reserved; 0 = normal operation

Table 38. Decoding of BAND bits

BAND2	BAND1	BAND0	Divider ratio M	Receiver band
0	0	0	-	reserved
0	0	1	2	FM
0	1	0	3	FM
0	1	1	6	AM
1	0	0	8	AM
1	0	1	10	AM
1	1	0	16	AM
1	1	1	20	AM

Table 39. Reference frequencies

FREF2	FREF1	FREF0	f _{ref}
0	0	0	100 kHz
0	0	1	50 kHz
0	1	0	25 kHz
0	1	1	20 kHz
1	0	0	10 kHz
1	0	1	reserved
1	1	0	reserved
1	1	1	reserved

Different PLL charge pump currents are used for different reference frequencies to maintain best PLL loop stability; see [Table 40](#).

Settings FREF[2:0] = 000 (100 kHz) and FREF[2:0] = 001 (50 kHz) include additional high current charge pump control to realize fast PLL locking within 1 ms.

Table 40. Charge pump source^[1]

FREF2	FREF1	FREF0	LOINJ	Charge pump current	f _{ref}
0	0	0	X	CP1	100 kHz
0	0	1	X	CP2	50 kHz
0	1	0	X	CP3	25 kHz
0	1	1	1	CP3	20 kHz
0	1	1	0	CP4	20 kHz
1	0	0	X	CP5	10 kHz
1	0	1	X	reserved	
1	1	0	X	reserved	
1	1	1	X	reserved	

[1] X = don't care.

8.2.7 Tuning overview

High injection LO (Europe FM, US FM and AM):

$$N = \frac{(f_{RF} + 10.7 \text{ MHz}) \times M}{f_{ref}} \text{ with LOINJ} = 0 \text{ to achieve full image suppression in FM.}$$

Low injection LO (Japan FM and OIRT):

$$N = \frac{(f_{RF} - 10.7 \text{ MHz}) \times M}{f_{ref}} \text{ with LOINJ} = 1 \text{ to achieve full image suppression in FM.}$$

$$\text{tuning step} = \frac{f_{ref}}{M}$$

where: M is the divider ratio of the VCO frequency for AM mixer 1 and FM mixer 1

$$M = \frac{f_{VCO}}{f_{mixer 1}}$$

Table 41. Standard tuner settings

Broadcast band	BAND[2:0]	M	FREF[2:0]	f _{ref}	LOINJ	Tuning step
Europe FM and US FM	001	2	000	100 kHz	0	50 kHz
Japan FM	010	3	000	100 kHz	1	33.3 kHz
Eastern Europe FM (OIRT FM)	010	3	011	20 kHz	1	6.67 kHz
AM MW and LW	111	20	011	20 kHz	0	1 kHz
AM SW 120 m to 60 m	110	16	100	10 kHz	0	0.625 kHz
AM SW 49 m to 22 m	101	10	100	10 kHz	0	1 kHz
AM SW 25 m to 15 m	100	8	100	10 kHz	0	1.25 kHz
AM SW 16 m to 11 m	011	6	100	10 kHz	0	1.67 kHz

8.2.8 Write mode: data byte LEVELALGN

Table 42. LEVELALGN - format of data byte 06h with default setting

7	6	5	4	3	2	1	0
LST4	LST3	LST2	LST1	LST0	LSL2	LSL1	LSL0
1	0	0	0	0	1	0	0

Table 43. LEVELALGN - data byte 06h bit description

Bit	Symbol	Description
7 to 3	LST[4:0]	level start voltage alignment
2 to 0	LSL[2:0]	level slope alignment

For I²C-bus reading of the level voltage and standard alignment see read data byte 1 (see [Table 10](#)).

Level alignment should begin with slope alignment (LSL): the level slope does not change with level start alignment (LST) or broadcast band; therefore a single LSL alignment setting can be used for all FM and AM band selections.

Level start may change between broadcast bands; therefore generally a separate LST alignment and setting is used for every broadcast band.

8.2.9 Write mode: data byte IFCF

Table 44. IFCF - format of data byte 07h with default setting

7	6	5	4	3	2	1	0
IFCFA	IFNBW	IFCF5	IFCF4	IFCF3	IFCF2	IFCF1	IFCF0
0	0	1	0	0	0	0	0

Table 45. IFCF - data byte 07 bit description

Bit	Symbol	Description
7	IFCFA	FM IF filter align mode 0 = normal operation 1 = align mode (fast frequency settling)
6	IFNBW	FM IF filter narrow 0 = normal operation 1 = FM IF filter at minimum bandwidth (57 kHz)
5 to 0	IFCF[5:0]	FM IF filter center frequency alignment

8.2.10 Write mode: data byte IFCAP

Table 46. IFCAP - format of data byte 08h with default setting

7	6	5	4	3	2	1	0
IFCAPA	0	0	0	IFCAP3	IFCAP2	IFCAP1	IFCAP0
0				1	0	0	0

Table 47. IFCAP - data byte 08h bit description

Bit	Symbol	Description
7	IFCAPA	FM IF filter capacitor align 0 = standard operation 1 = align mode and initialization mode (auto correct disabled)
6 to 4	-	reserved; 0 = normal operation
3 to 0	IFCAP[3:0]	IF filter capacitor. Setting of FM IF filter capacitor value by means of bit IFCAPG of read data byte 5, ID; see Table 19 (For initialization set IFCAPA = 1. For alignment set IFCAPA = 1 and check, when read bit IFCAPG changes from logic 0 to logic 1).

The fully integrated IF2 filter of the TEF6901A has to be aligned in order to achieve the optimum performance at all ambient conditions.

8.2.10.1 Factory alignment of bits IFCAP[3:0]

FM IF filter operation point alignment: data byte IFCAP: a single alignment of the FM IF filter operation range secures an accurate and continuous frequency setting over the full temperature range and all FM bands.

1. Set bit IFCAPA to logic 1 to disable internal IFCAP control
2. Decrease IFCAP from 15 downwards until I²C-bus read bit IFCAPG (read byte 5; ID) changes from logic 1 to logic 0
3. Save this IFCAP setting as alignment value
4. Set bit IFCAPA to logic 0 to return to normal operation

8.2.10.2 Initialization of the radio

During radio initialization bit IFCAPA (is logic 1) is used for writing the stored IFCAP[3:0] value. Afterwards set bit IFCAPA to a logic 0 to start normal operation. Writing of the IFCAP byte with the alignment value is allowed during radio operation but requires a setting of bit IFCAPA to logic 0.

8.2.10.3 Factory alignment of IFCF

FM IF filter center frequency alignment: data byte IFCF: to correct IF frequency errors caused by an error in the crystal frequency the alignment is preferably performed for every FM band in use. A test frequency in the center of the band is preferred. An accurate alignment result is realized by testing for symmetrical filter attenuation.

1. Set RF generator level $V_{RF} = 200 \mu V$
2. Set bit IFCFA to logic 1 to enable fast settling of the filter frequency
3. Set bit IFNBW to logic 1 for accuracy (filter is set to narrow 57 kHz bandwidth)
4. Test high side of filter curve: tune to $f_{RF} - 50 \text{ kHz}$ (Europe/USA) or $f_{RF} + 33.3 \text{ kHz}$ (Japan/OIRT)
5. Change IFCF from 0 to 63 and note the level read result (level voltages)
6. Test low side of filter curve: tune to $f_{RF} + 50 \text{ kHz}$ (Europe/USA) or $f_{RF} - 33.3 \text{ kHz}$ (Japan/OIRT)
7. Change IFCF from 0 to 63 and note the level voltages
8. Find the IFCF value where both level curves cross (lowest difference) and save this IFCF value

9. Set bits IFCFA and IFNBW to logic 0 to return to normal operation

The bits IFCFA and IFNBW are intended for factory alignment use only. Normal radio operation requires a setting of bits IFCFA and IFNBW to logic 0.

8.2.11 Write mode: data byte ACD

Table 48. ACD - format of data byte 09h with default setting

7	6	5	4	3	2	1	0
ACDLEV	ACDLAP1	ACDLAP0	ACDBAL1	ACDBAL0	ACDWAM1	ACDWAM0	HCSFH
0	1	0	0	1	0	1	0

Table 49. ACD - data byte 09h bit description

Bit	Symbol	Description
7	ACDLEV	level threshold; start level of threshold extension and latch protection 0 = start at LEV = 40 ($V_{LEVEL} = 0.88$ V), normal operation 1 = start at LEV = 48 ($V_{LEVEL} = 1$ V)
6 and 5	ACDLAP[1:0]	latch protection limit; protect against narrow bandwidth locking at high modulation, low RF signal condition 00 = no protection 01 = low protection 10 = standard protection 11 = high protection
4 and 3	ACDBAL[1:0]	control balance; bandwidth control priority towards adjacent channel (prevent breakthrough) or towards modulation (low distortion) 00 = high adjacent channel priority 01 = medium adjacent channel priority, standard operation 10 = medium modulation priority 11 = high modulation priority
2 and 1	ACDWAM[1:0]	WAM threshold; desensitize bandwidth control at detection of WAM 00 = no desensitization on WAM 01 = low sensitivity 10 = medium sensitivity 11 = high sensitivity
0	HCSFH	HCC minimum bandwidth; combined control with bit HCSF; see Table 57 , Table 60 and Figure 26 0 = minimum bandwidth of high cut control is 2.2 kHz or 3.3 kHz 1 = minimum bandwidth of high cut control is 3.9 kHz or 5.6 kHz

8.2.12 Write mode: data byte SENSE

Table 50. SENSE - format of data byte 0Ah with default setting

7	6	5	4	3	2	1	0
CSA3	CSA2	CSA1	CSA0	USS1	USS0	WAS1	WAS0
1	0	0	0	0	1	0	1

Table 51. SENSE - data byte 0Ah bit description

Bit	Symbol	Description
7 to 4	CSA[3:0]	alignment of FM stereo channel separation
3 and 2	USS[1:0]	USN sensitivity; USN weak signal control equivalent level voltage/frequency deviation for weak signal processing; see Figure 24 00 = -0.06 V/kHz 01 = -0.08 V/kHz 10 = -0.12 V/kHz 11 = -0.16 V/kHz
1 and 0	WAS[1:0]	WAM sensitivity; WAM weak signal control equivalent level voltage/V _{LEVEL} (peak-to-peak) for weak signal processing; see Figure 24 00 = -7.5 01 = -10 10 = -15 11 = -20

The input control value for weak signal control derived from USN is denoted by $V_{eq.LEVEL}$; equivalent level voltage. This indicates a weak signal control amount equal to the weak signal control generated by a certain V_{LEVEL} voltage.

The USS setting does not influence the I²C-bus read quality information of USN; read data byte 2, USN/WAM; see [Table 12](#).

The input control value for weak signal control derived from WAM is denoted by $V_{eq.LEVEL}$; equivalent level voltage. This indicates a weak signal control amount equal to the weak signal control generated by a certain V_{LEVEL} voltage.

The WAS setting does not influence the I²C-bus read quality information of WAM; read data byte 2, USN/WAM; see [Table 12](#).

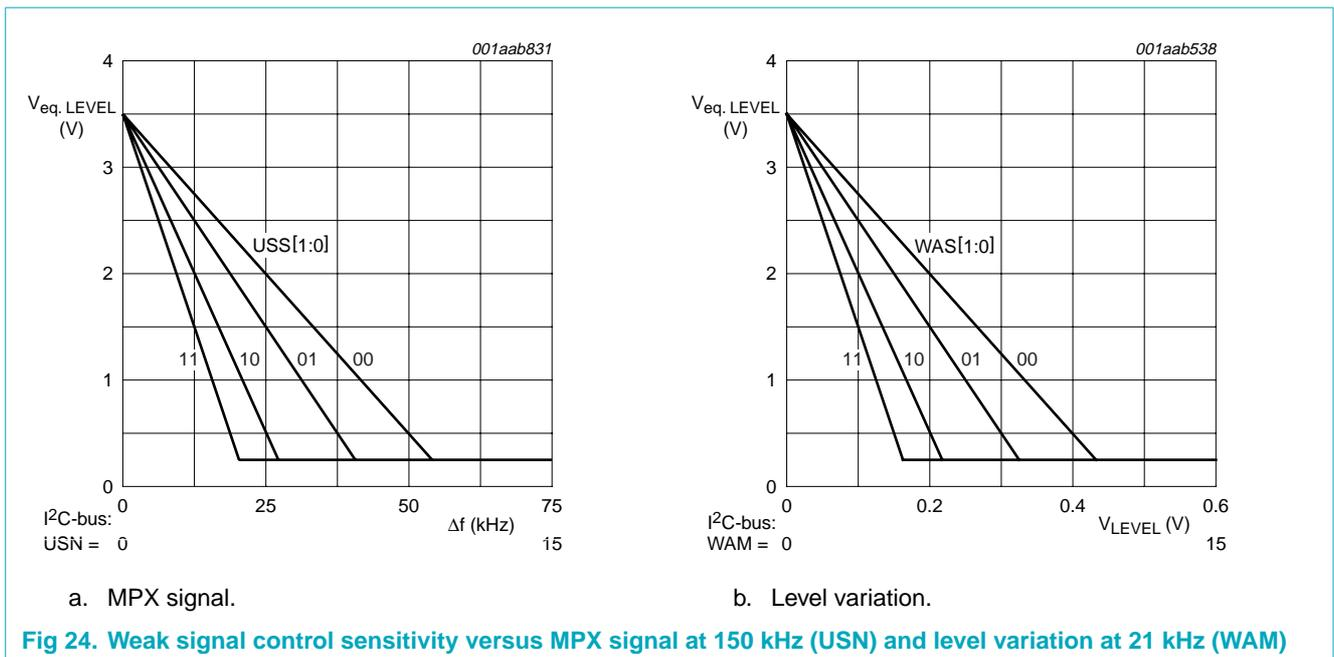

Fig 24. Weak signal control sensitivity versus MPX signal at 150 kHz (USN) and level variation at 21 kHz (WAM)

8.2.13 Write mode: data byte TIMING

Table 52. TIMING - format of data byte 0Bh with default setting

7	6	5	4	3	2	1	0
STC1	STC0	HTC2	HTC1	HTC0	MTC2	MTC1	MTC0
1	0	1	0	0	1	1	0

Table 53. TIMING - data byte 0Bh bit description^[1]

Bit	Symbol	Description
7 and 6	STC[1:0]	setting of the stereo noise control time constants; see Table 54
5 to 3	HTC[2:0]	setting of the high cut control time constants; see Table 55
2 to 0	MTC[2:0]	setting of the soft mute control time constants; see Table 56

[1] During the tuning mute of the preset and search mode tuning action the time constants set by STC, HTC and MTC change to $t_{\text{attack}} = 50 \text{ ms}$ and $t_{\text{recovery}} = 50 \text{ ms}$ to enable fast settling of the weak signal processing to new conditions.

Table 54. SNC weak signal processing control speed setting

STC1	STC0	t_{attack}	t_{recovery}
0	0	0.1 s	1.25 s
0	1	0.1 s	2.5 s
1	0	0.1 s	5 s
1	1	0.1 s	10 s

Table 55. HCC speed setting^[1]

HTC2	HTC1	HTC0	t_{attack}	t_{recovery}
0	0	0	0.03 s	0.04 s
0	0	1	0.03 s	0.08 s
0	1	0	0.06 s	0.3 s
0	1	1	0.25 s	0.3 s
1	0	0	0.25 s	0.6 s
1	0	1	0.5 s	0.6 s
1	1	0	1 s	1.25 s
1	1	1	1 s	2.5 s

[1] When for an external audio source VU-meter mode is enabled (bits AVUM or COMP are logic 1) the HTC setting controls the t_{recovery} VU-meter timing, t_{attack} has a fixed value of 20 ms; see [Table 99](#).

Table 56. Soft mute weak signal processing control speed setting^[1]

MTC2	MTC1	MTC0	t _{attack} ^[2]	t _{recovery} ^[3]
0	0	0	0.01 s	0.01 s
0	0	1	0.01 s	0.03 s
0	1	0	0.03 s	0.1 s
0	1	1	0.1 s	0.1 s
1	0	0	0.1 s	0.2 s
1	0	1	0.2 s	0.2 s
1	1	0	0.4 s	0.4 s
1	1	1	0.4 s	0.8 s

[1] When for an external audio source dynamic compression is enabled (bit COMP is logic 1) the MTC setting controls the t_{recovery} compression timing, t_{attack} has a fixed value of 20 ms; see [Table 80](#).

[2] The attack time is the time, which the weak signal processing needs to realize a full control change for a level voltage change between HIGH level (where the weak signal processing is inactive) and 0.75 V level voltage.

[3] The recovery time is the time needed for the full control change when the level voltage rises from 0.75 V to HIGH level.

8.2.14 Write mode: data byte SNC

Table 57. SNC - format of data byte 0Ch with default setting

7	6	5	4	3	2	1	0
SST3	SST2	SST1	SST0	SSL1	SSL0	HCMP	HCSF
0	1	1	1	0	1	0	0

Table 58. SNC - data byte 0Ch bit description

Bit	Symbol	Description
7 to 4	SST[3:0]	SNC start; start setting of the stereo noise control; see Table 59 and Figure 25
3 and 2	SSL[1:0]	SNC slope; slope setting of the stereo noise control ($\alpha_{sep}/V_{eq,LEVEL}$); see Figure 25 00 = 38 dB/V 01 = 51 dB/V 10 = 63 dB/V 11 = 72 dB/V
1	HCMP	HCC control source 0 = high cut control is only controlled by the level information 1 = high cut control is controlled by level, USN and WAM
0	HCSF	HCC minimum bandwidth; combined control with bit HCSFH; see Table 49 , Table 60 and Figure 26

Table 59. Start of stereo noise control weak signal processing

SST3	SST2	SST1	SST0	Stereo noise control start ($V_{eq,LEVEL}$)
0	0	0	0	1.88 V
0	0	0	1	1.94 V
0	0	1	0	2.00 V
0	0	1	1	2.06 V
0	1	0	0	2.13 V
0	1	0	1	2.19 V
0	1	1	0	2.25 V
0	1	1	1	2.31 V
1	0	0	0	2.38 V
1	0	0	1	2.44 V
1	0	1	0	2.5 V
1	0	1	1	2.56 V
1	1	0	0	2.63 V
1	1	0	1	2.69 V
1	1	1	0	2.75 V
1	1	1	1	2.81 V

Table 60. HCC minimum bandwidth

HCSFH	HCSF	High cut control minimum bandwidth
0	0	2.2 kHz
0	1	3.3 kHz
1	0	3.9 kHz
1	1	5.6 kHz

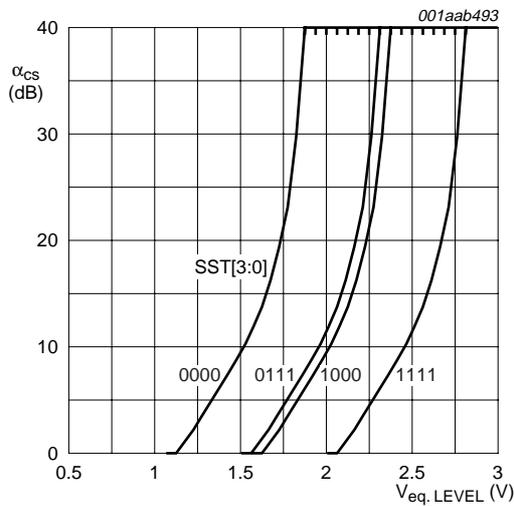

SSL = 63 dB/V.

a. Start.

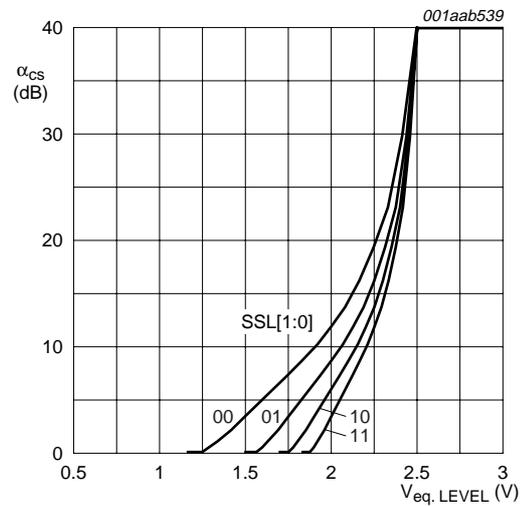

SST = 2.5 V.

b. Slope.

Fig 25. Stereo Noise Control (SNC) start and slope settings versus equivalent level voltage; SNC detector (level, USN and WAM), USN detector and WAM detector

8.2.15 Write mode: data byte HIGHCUT

Table 61. HIGHCUT - format of data byte 0Dh with default setting

7	6	5	4	3	2	1	0
HST2	HST1	HST0	HSL1	HSL0	HCF2	HCF1	HCF0
0	1	1	0	1	1	1	1

Table 62. HIGHCUT - data byte 0Dh bit description

Bit	Symbol	Description
7 to 5	HST[2:0]	HCC start; start setting of the high cut control; see Table 63 and Figure 26
4 and 3	HSL[1:0]	HCC slope; slope setting of the high cut control ($\alpha_{10 \text{ kHz}/V_{\text{eq.LEVEL}}}$); see Figure 26 00 = 9 dB/V 01 = 11 dB/V 10 = 14 dB/V 11 = 18 dB/V
2 to 0	HCF[2:0]	HCC maximum bandwidth; setting of the fixed high cut control; see Table 64 , Figure 26 and Figure 27

Table 63. Start of high cut control weak signal processing

HST2	HST1	HST0	High cut control start ($V_{eq.LEVEL}$)
0	0	0	1.5 V
0	0	1	1.75 V
0	1	0	2.0 V
0	1	1	2.25 V
1	0	0	2.5 V
1	0	1	3.0 V
1	1	0	3.5 V
1	1	1	4.0 V

Table 64. Fixed high cut settings

HCF2	HCF1	HCF0	Fixed high cut; HCC B_{max}
0	0	0	reserved
0	0	1	2 kHz
0	1	0	3 kHz
0	1	1	5 kHz
1	0	0	7 kHz
1	0	1	10 kHz
1	1	0	wide bandwidth
1	1	1	full bandwidth

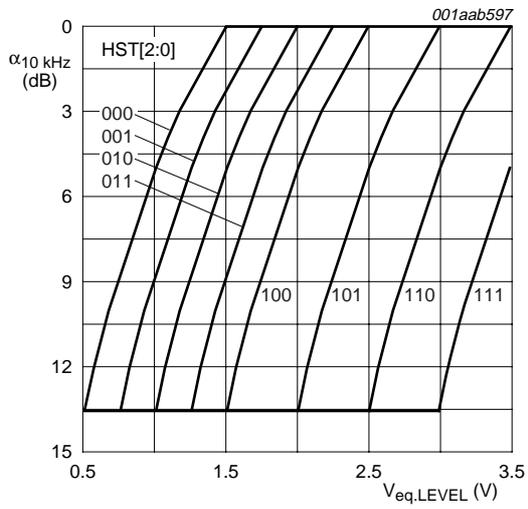

HCF = 111, HCSF = 0, HCSFH = 0, HSL = 10.

a. Start.

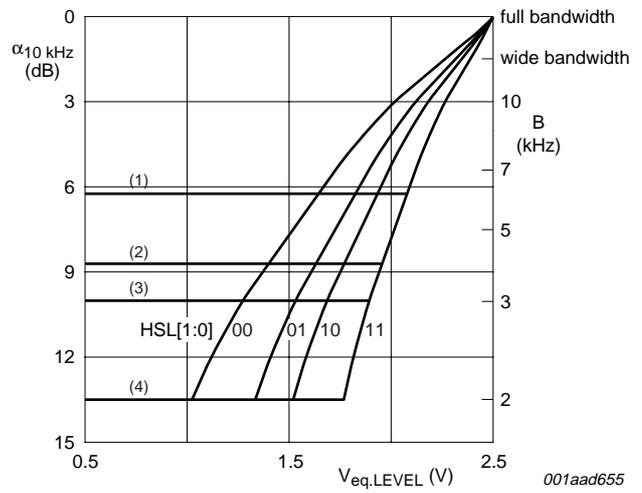

HST = 100.

- (1) HCSFH = 1; HCSF = 1; B_{min} = 5.6 kHz.
- (2) HCSFH = 1; HCSF = 0; B_{min} = 3.9 kHz.
- (3) HCSFH = 0; HCSF = 1; B_{min} = 3.3 kHz.
- (4) HCSFH = 0; HCSF = 0; B_{min} = 2.2 kHz.

b. Slope and minimum bandwidth.

Fig 26. High cut control start and slope settings versus equivalent level voltage; HCC detector (HCMP = 0 for level or HCMP = 1 for level, WAM and USN)

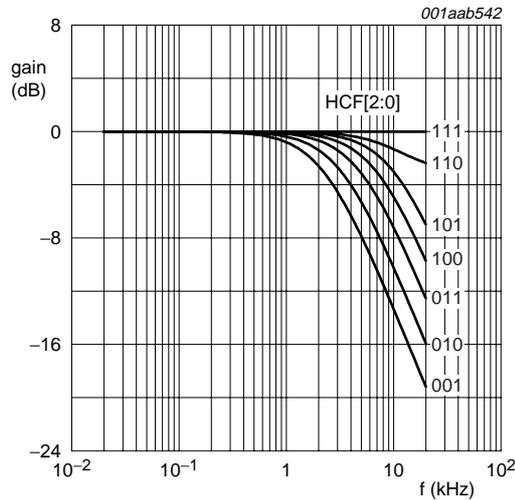

Fig 27. Fixed high cut setting characteristics

8.2.16 Write mode: data byte SOFTMUTE

Table 65. SOFTMUTE - format of data byte 0Eh with default setting

7	6	5	4	3	2	1	0
MST2	MST1	MST0	MSL1	MSL0	UMD1	UMD0	MSLE
0	1	1	0	1	0	1	0

Table 66. SOFTMUTE - data byte 0Eh bit description

Bit	Symbol	Description
7 to 5	MST[2:0]	soft mute start; start setting of the soft mute; for FM see Table 67 and Figure 28 ; for AM see Table 68 and Figure 29
4 and 3	MSL[1:0]	soft mute slope ^[1] ; slope setting of the soft mute ($\alpha_{10\text{ kHz}}/V_{\text{eq.LEVEL}}$); for FM see Table 69 and see Figure 28 ; for AM see Table 70 and Figure 29
2 and 1	UMD[1:0]	USN soft mute depth; setting of the maximum attenuation of the USN fast soft mute control; see Figure 30 00 = 3 dB 01 = 6 dB 10 = 9 dB 11 = 12 dB
0	MSLE	soft mute slope extension; additional slope setting of the soft mute; for FM see Table 69 and Figure 28 ; for AM see Table 70 and Figure 29

[1] When for an external audio source dynamic compression is enabled (bit COMP is logic 1) the MSL setting controls the compression ratio. For default 2 : 1 compression MSL = 01 is used; see [Table 82](#).

Table 67. Start of soft mute control weak signal processing; FM mode^[1]

MST2	MST1	MST0	Soft mute control start ($V_{\text{eq.LEVEL}}$)
0	0	0	0.88 V
0	0	1	1.0 V
0	1	0	1.12 V
0	1	1	1.25 V
1	0	0	1.38 V
1	0	1	0.75 V
1	1	0	0.81 V
1	1	1	0.94 V

[1] When for an external audio source dynamic compression is enabled (COMP = 1) the MST setting controls the compression range. For default full compression MST = 7 is used; see [Table 81](#).

Table 68. Start of soft mute control weak signal processing; AM mode^[1]

MST2	MST1	MST0	Soft mute control start ($V_{eq.LEVEL}$)
0	0	0	1.5 V
0	0	1	1.75 V
0	1	0	2.0 V
0	1	1	1.25 V
1	0	0	1.38 V
1	0	1	1.62 V
1	1	0	1.88 V
1	1	1	2.12 V

[1] When for an external audio source dynamic compression is enabled (COMP = 1) the MST setting controls the compression range. For default full compression MST = 7 is used; see [Table 81](#).

Table 69. Slope of soft mute control weak signal processing; FM mode^[1]

MSLE	MSL1	MSL0	Soft mute control slope ($\alpha_{AF}/V_{eq.LEVEL}$)
0	0	0	8 dB/V
0	0	1	16 dB/V
0	1	0	24 dB/V
0	1	1	32 dB/V
1	0	0	40 dB/V
1	0	1	48 dB/V
1	1	0	reserved
1	1	1	reserved

[1] When for an external audio source dynamic compression is enabled (COMP = 1) the MSL setting controls the compression range. For default 2 : 1 compression MSL = 1 is used; see [Table 82](#).

Table 70. Slope of soft mute control weak signal processing; AM mode^[1]

MSL1	MSL0	MSLE	Soft mute control slope ($\alpha_{AF}/V_{eq.LEVEL}$)
0	0	0	8 dB/V
0	0	1	12 dB/V
0	1	0	16 dB/V
0	1	1	20 dB/V
1	0	0	24 dB/V
1	0	1	28 dB/V
1	1	0	32 dB/V
1	1	1	36 dB/V

[1] When for an external audio source dynamic compression is enabled (COMP = 1) the MSL setting controls the compression range. For default 2 : 1 compression MSL = 1 is used; see [Table 82](#).

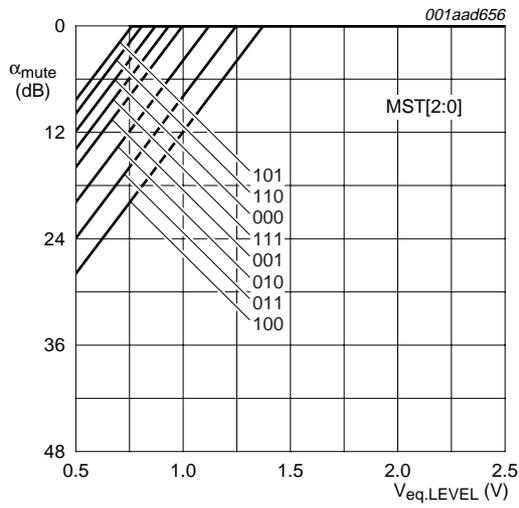

MSL[1:0] = 11.

a. Start.

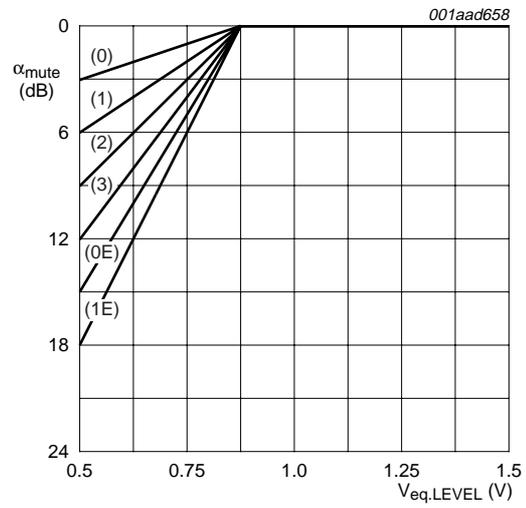

MST[2:0] = 000.

(0) MSLE = 0; MSL[1:0] = 00.

(1) MSLE = 0; MSL[1:0] = 01.

(2) MSLE = 0; MSL[1:0] = 10.

(3) MSLE = 0; MSL[1:0] = 11.

(0E) MSLE = 1; MSL[1:0] = 00.

(1E) MSLE = 1; MSL[1:0] = 01.

b. Slope.

Fig 28. Soft mute start and slope settings versus equivalent level voltage (FM mode)

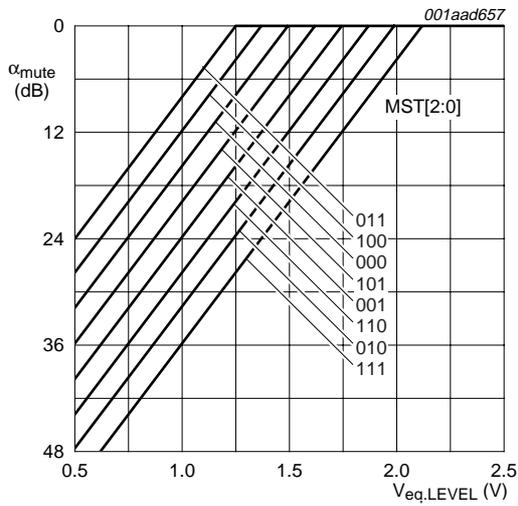

MSL[1:0] = 11.

a. Start.

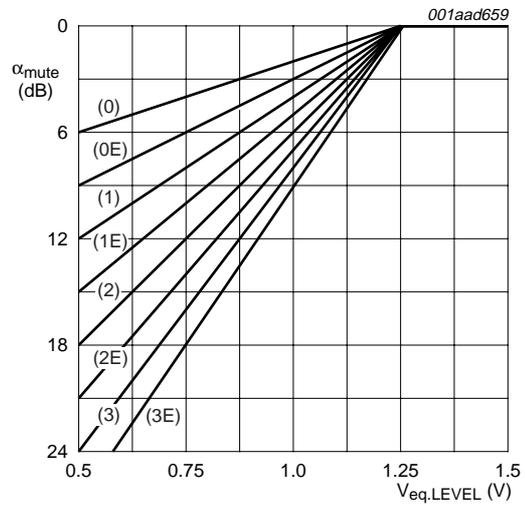

MST[2:0] = 011.

- (0) MSL[1:0] = 00; MSLE = 0.
- (0E) MSL[1:0] = 00; MSLE = 1.
- (1) MSL[1:0] = 01; MSLE = 0.
- (1E) MSL[1:0] = 01; MSLE = 1.
- (2) MSL[1:0] = 10; MSLE = 0.
- (2E) MSL[1:0] = 10; MSLE = 1.
- (3) MSL[1:0] = 11; MSLE = 0.
- (3E) MSL[1:0] = 11; MSLE = 1.

b. Slope.

Fig 29. Soft mute start and slope settings versus equivalent level voltage (AM mode)

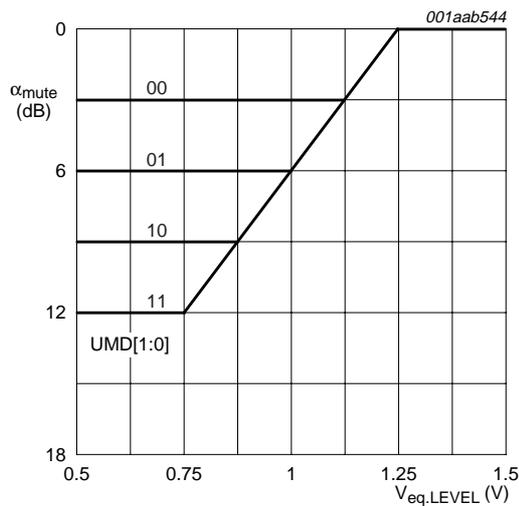

MST[2:0] = 011, MSL[1:0] = 10.

Fig 30. USN soft mute depth settings; USN detector

8.2.17 Write mode: data byte RADIO

Table 71. RADIO - format of data byte 0Fh with default setting

7	6	5	4	3	2	1	0
0	MONO	DEMP	RDCL	NBS1	NBS0	NBL1	NBL0
	0	0	1	1	0	1	0

Table 72. RADIO - data byte 0Fh bit description

Bit	Symbol	Description
7	-	reserved; 0 = normal operation
6	MONO	FM forced mono; stereo decoder disable option 0 = stereo decoder is set to FM stereo 1 = stereo decoder is set to FM mono
5	DEMP	de-emphasis; selection of the de-emphasis time constant; see Figure 31 0 = de-emphasis is 75 μ s 1 = de-emphasis is 50 μ s
4	RDCL	RDS output mode 0 = direct output mode; clock output and data output; see Figure 32 1 = buffered output mode; clock input and data output of 16-bit data buffer and optional 3-bit demodulation quality (RDQ counter); see Figure 33
3 and 2	NBS[1:0]	noise blanker audio sensitivity FM audio noise blanker sensitivity setting of FM MPX ignition noise detector (peak value) 00 = 65 mV (high sensitivity) 01 = 100 mV 10 = 125 mV 11 = 160 mV (low sensitivity) AM audio noise blanker sensitivity setting of audio ignition noise detector 00 = 16.5 V/ms 01 = 18.6 V/ms 10 = 21 V/ms 11 = 23.5 V/ms
1 and 0	NBL[1:0]	noise blanker IF or level sensitivity FM audio noise blanker sensitivity setting of FM level ignition noise detector (peak value) 00 = 10 mV 01 = 25 mV 10 = 36 mV 11 = 50 mV AM IF noise blanker sensitivity setting of IF ignition noise detector 00 = 1.4 V (low sensitivity) 01 = 1 V 10 = 0.7 V (high sensitivity) 11 = AM IF noise blanker disabled

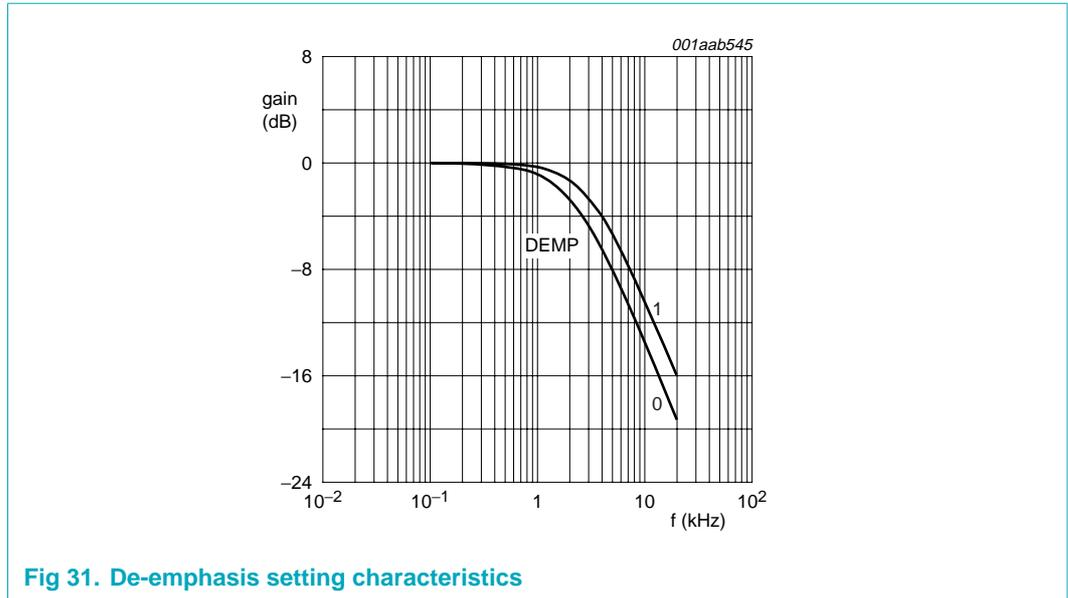

Fig 31. De-emphasis setting characteristics

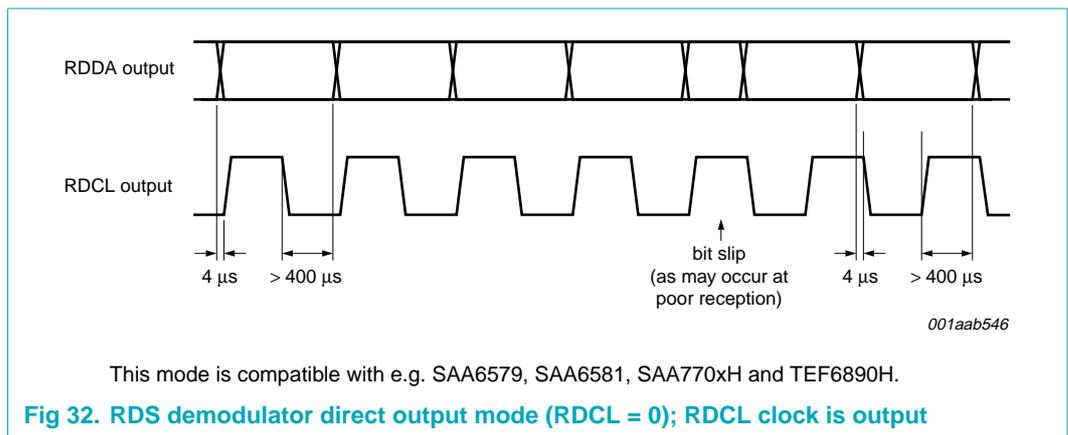
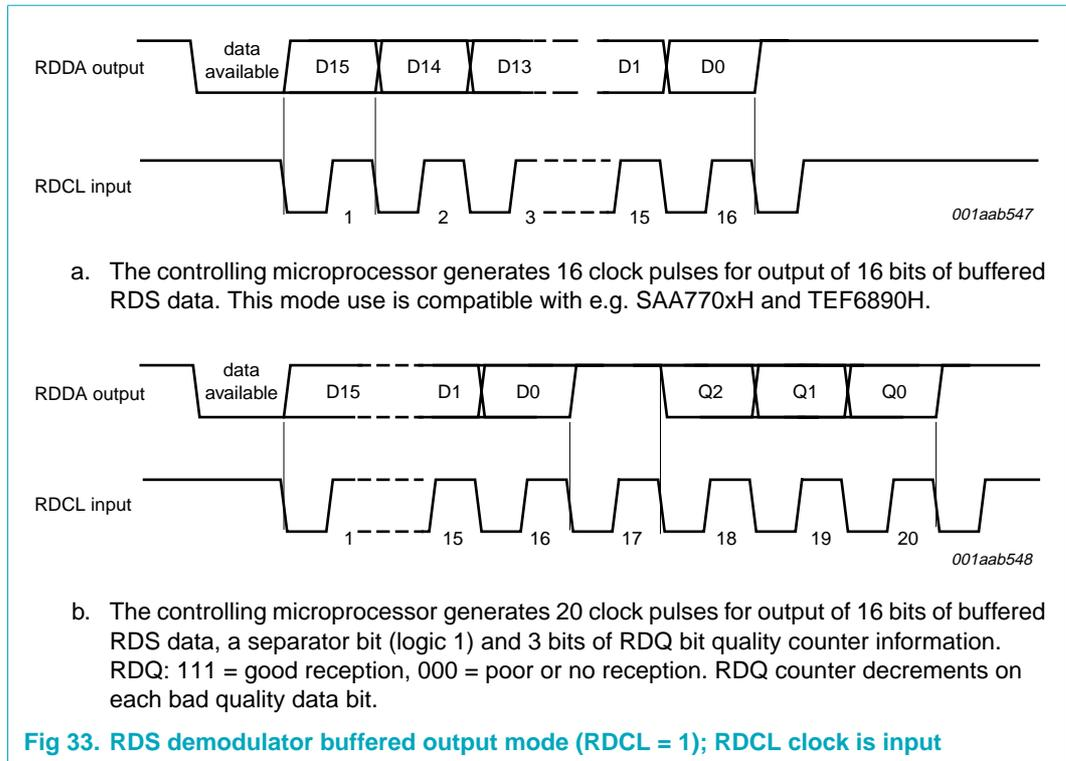

Fig 32. RDS demodulator direct output mode (RDCL = 0); RDCL clock is output



8.2.18 Write mode: data byte INPUT

Table 73. INPUT - format of data byte 10h with default setting

7	6	5	4	3	2	1	0
INP3	INP2	INP1	INP0	ING3	ING2	ING1	ING0
0	0	0	0	1	0	1	0

Table 74. INPUT - data byte 10h bit description

Bit	Symbol	Description
7 to 4	INP[3:0]	input selection; selection of the audio source for the tone/volume part; see Table 75
3 to 0	ING[3:0]	Input gain; -10 dB to +18 dB input gain. The ING input gain setting is added to the VOL volume setting to define the actual volume control; see Table 76.

Table 75. Input select

INP3	INP2	INP1	INP0	Audio source for tone/volume processing
0	0	0	0	radio
0	0	0	1	stereo with CMR (INAL, INAR and INAC)
0	0	1	0	stereo (INBL and INBR)
0	0	1	1	mono symmetrical or mono with CMR (INC and IND)
0	1	0	0	stereo (INC and IND)
0	1	0	1	mono (INC)
0	1	1	0	mono (IND)
0	1	1	1	stereo with CMR (INBL, INBR and INC)
1	0	0	0	stereo symmetrical (INBL, INBR, INC and IND)
1	0	0	1	stereo (INAL and INAR)
1	0	1	0	mono (INAC)
1	0	1	1	reserved
1	1	0	0	reserved
1	1	0	1	reserved
1	1	1	0	reserved
1	1	1	1	reserved

Table 76. Input gain setting

ING3	ING2	ING1	ING0	Input gain control
1	0	1	1	-10 dB ^[1]
1	1	0	0	-8 dB
1	1	0	1	-6 dB
1	1	1	0	-4 dB
1	1	1	1	-2 dB
0	0	0	0	0 dB
0	0	0	1	2 dB
0	0	1	0	4 dB
0	0	1	1	6 dB
0	1	0	0	8 dB
0	1	0	1	10 dB ^[1]
0	1	1	0	12 dB ^[1]
0	1	1	1	14 dB ^[1]
1	0	0	0	16 dB ^[1]
1	0	0	1	18 dB ^[1]
1	0	1	0	mute

[1] The input gain setting ING and the volume setting VOL define the overall volume. The overall range is limited to -83 dB to +26 dB. For overall values > +28 dB the actual gain is +28 dB. For overall values < -83 dB the circuit is muted.

Table 77. Input select pin use and suggested combinations of input sources^[1]

INP	Input pin use							Audio source	Source combinations							
	AL	AR	AC	BL	BR	C	D									
0000								radio	x	x	x	x	x	x	x	x
0001	L	R	GND					stereo CMR	x	x	x	x	x			
0010				L	R			stereo	x	x	x				x	x
0011						M-	M+	mono symmetrical	x						x	
0100						L-	R-	stereo		x						x
0101						M-		mono			x					x
0110							M	mono			x	x				x
0111				L	R	GND		stereo CMR				x				
1000				L+	R+	L-	R-	stereo symmetrical					x	x		
1001	L	R						stereo						x	x	x
1010			M-					mono						x	x	x

[1] M-, L- and R- indicate inverted polarity of audio signal.

8.2.19 Write mode: data byte VOLUME

Table 78. VOLUME - format of data byte 11h with default setting

7	6	5	4	3	2	1	0
COMP	VOL6	VOL5	VOL4	VOL3	VOL2	VOL1	VOL0
0	0	1	1	0	0	0	0

Table 79. VOLUME - data byte 11h bit description

Bit	Symbol	Description
7	COMP	dynamic compression ^[1] ; see Figure 36 0 = compression is disabled (standard use) 1 = dynamic compression is enabled
6 to 0	VOL[6:0]	volume setting (see Table 83); for balance control see data byte 16h (see Table 94), for loudness control see data byte 17h (see Table 97)

[1] Dynamic compression can be used with external sources only. When dynamic compression is active, the radio quality detection of USN, MOD and OFFS is limited to AF update tuning only. For dynamic compression the bits MOD[4:0] indicate the external source input amplitude as in the VU-meter mode; AVUM; data byte 17h (see [Table 97](#)). The FM dynamic bandwidth control is disabled and a fixed bandwidth of 113 kHz is defined. However, other fixed bandwidth settings are available by DYN = 0 and the setting of BW; data byte 0h (see [Table 28](#)). The compression recovery timing is controlled by data byte 0Bh; TIMING (see [Table 80](#)). Compression start and slope are controlled by data byte 0Eh; SOFTMUTE (see [Table 81](#) and [Table 82](#)). Standard compression requires a setting of MST = 7 and MSL = 1.

Table 80. Dynamic compression timing; MTC[2:0] of data byte 0Bh; TIMING^[1]

MTC2	MTC1	MTC0	t _{attack}	t _{recovery}
0	0	0	0.02 s	0.03 s
0	0	1	0.02 s	0.06 s
0	1	0	0.02 s	0.2 s
0	1	1	0.02 s	5 s
1	0	0	0.02 s	0.6 s
1	0	1	0.02 s	10 s
1	1	0	0.02 s	1 s
1	1	1	0.02 s	2 s

[1] Setting MTC is also in use for setting the timing of weak signal soft mute control during radio operation.

Table 81. Dynamic compression start; MST[2:0] of data byte 0Eh; SOFTMUTE^[1]

MST2	MST1	MST0	Compression range
0	0	0	reserved
0	0	1	reserved
0	1	0	reserved
0	1	1	start = 4 dBV; 2 : 1 range = 2 dB
1	0	0	start = -4 dBV; 2 : 1 range = 6 dB
1	0	1	start = -12 dBV; 2 : 1 range = 10 dB
1	1	0	start = -20 dBV; 2 : 1 range = 14 dB
1	1	1	start = -34 dBV; full range (2 : 1 = 18 dB)

[1] Setting MST is also in use for setting the start of weak signal soft mute control during radio operation.

Table 82. Dynamic compression slope; MSL[1:0] of data byte 0Eh; SOFTMUTE^[1]

MSL1	MSL0	Compression ratio
0	0	4 : 3; full range = 9 dB
0	1	standard compression (2 : 1); full range = 18 dB
1	0	4 : 1; full range = 27 dB
1	1	limiting; full range = 36 dB

[1] Setting MSL is also in use for setting the slope of weak signal soft mute control during radio operation.

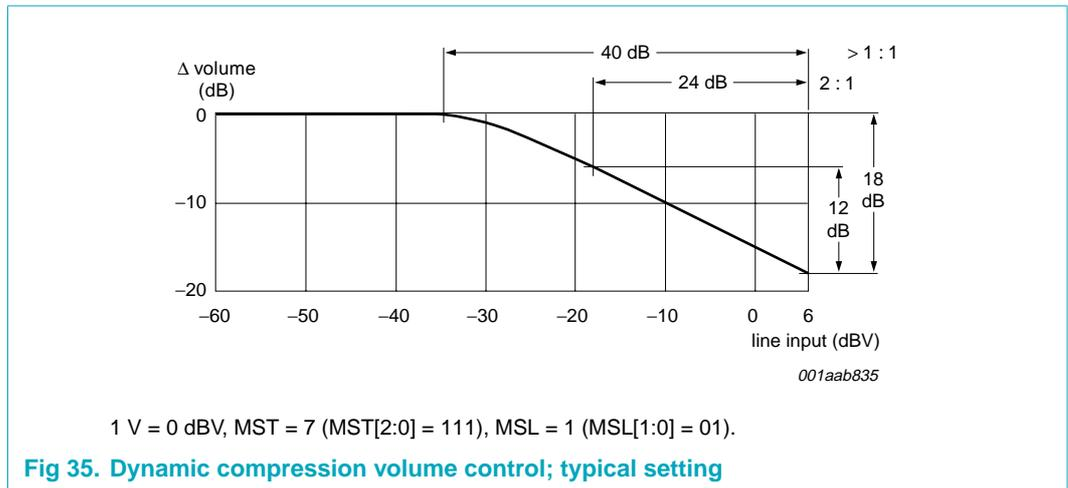
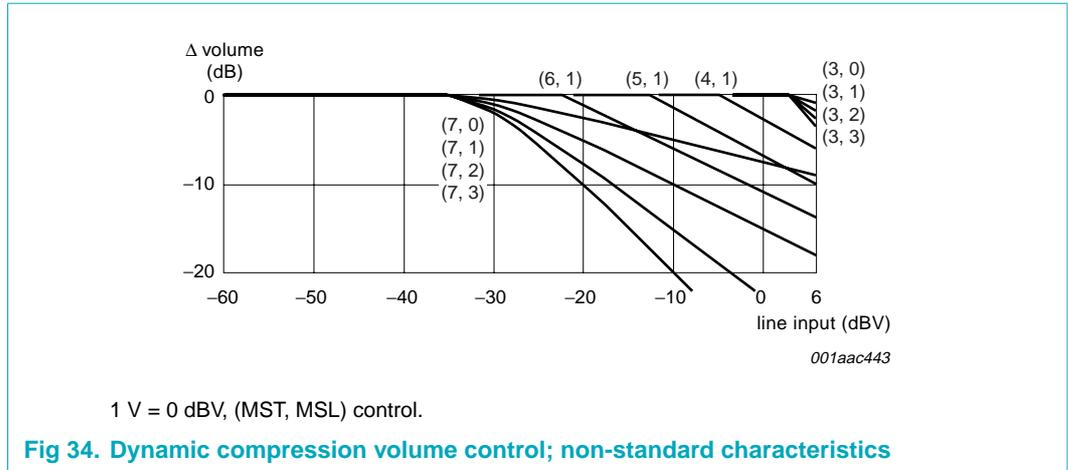

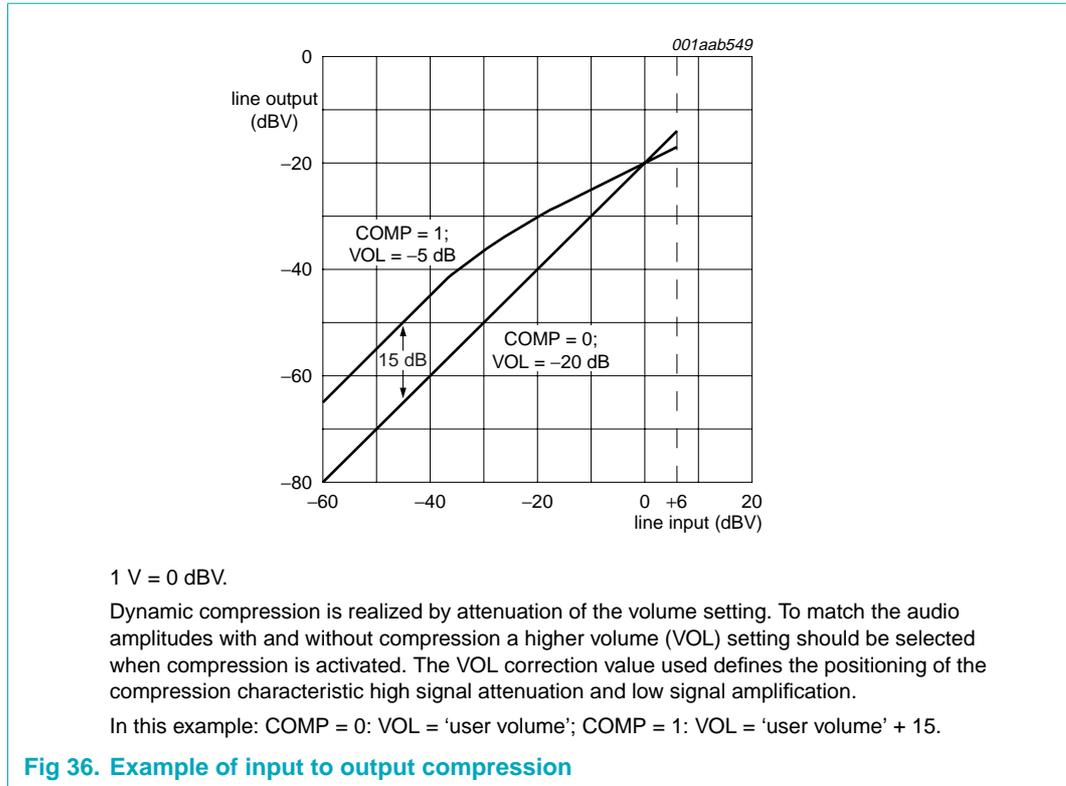

Table 83. Volume setting

VOL6	VOL5	VOL4	VOL3	VOL2	VOL1	VOL0	Volume (dB)
0	0	0	0	0	0	0	28 ^[1]
0	0	0	0	0	0	1	27 ^[1]
0	0	0	0	0	1	0	26 ^[1]
0	0	0	0	0	1	1	25 ^[1]
0	0	0	0	1	0	0	24 ^[1]
0	0	0	0	1	0	1	23 ^[1]
0	0	0	0	1	1	0	22 ^[1]
0	0	0	0	1	1	1	21 ^[1]
0	0	0	1	0	0	0	20 ^[1]
0	0	0	1	0	0	1	19 ^[1]
0	0	0	1	0	1	0	18 ^[1]
0	0	0	1	0	1	1	17 ^[1]
0	0	0	1	1	0	0	16 ^[1]
0	0	0	1	1	0	1	15 ^[1]
0	0	0	1	1	1	0	14 ^[1]
0	0	0	1	1	1	1	13 ^[1]
0	0	1	0	0	0	0	12 ^[1]
0	0	1	0	0	0	1	11 ^[1]
0	0	1	0	0	1	0	10
0	0	1	0	0	1	1	9

Table 83. Volume setting ...continued

VOL6	VOL5	VOL4	VOL3	VOL2	VOL1	VOL0	Volume (dB)
0	0	1	0	1	0	0	8
0	0	1	0	1	0	1	7
0	0	1	0	1	1	0	6
0	0	1	0	1	1	1	5
0	0	1	1	0	0	0	4
0	0	1	1	0	0	1	3
0	0	1	1	0	1	0	2
0	0	1	1	0	1	1	1
0	0	1	1	1	0	0	0
0	0	1	1	1	0	1	-1
0	0	1	1	1	1	0	-2
0	0	1	1	1	1	1	-3
0	1	0	0	0	0	0	-4
0	1	0	0	0	0	1	-5
0	1	0	0	0	1	0	-6
0	1	0	0	0	1	1	-7
0	1	0	0	1	0	0	-8
0	1	0	0	1	0	1	-9
0	1	0	0	1	1	0	-10
0	1	0	0	1	1	1	-11
0	1	0	1	0	0	0	-12
0	1	0	1	0	0	1	-13
0	1	0	1	0	1	0	-14
0	1	0	1	0	1	1	-15
0	1	0	1	1	0	0	-16
0	1	0	1	1	0	1	-17
0	1	0	1	1	1	0	-18
0	1	0	1	1	1	1	-19
0	1	1	0	0	0	0	-20
0	1	1	0	0	0	1	-21
0	1	1	0	0	1	0	-22
0	1	1	0	0	1	1	-23
0	1	1	0	1	0	0	-24
0	1	1	0	1	0	1	-25
0	1	1	0	1	1	0	-26
0	1	1	0	1	1	1	-27
0	1	1	1	0	0	0	-28
0	1	1	1	0	0	1	-29
0	1	1	1	0	1	0	-30
0	1	1	1	0	1	1	-31
0	1	1	1	1	0	0	-32

Table 83. Volume setting ...continued

VOL6	VOL5	VOL4	VOL3	VOL2	VOL1	VOL0	Volume (dB)
0	1	1	1	1	0	1	-33
0	1	1	1	1	1	0	-34
0	1	1	1	1	1	1	-35
1	0	0	0	0	0	0	-36
1	0	0	0	0	0	1	-37
1	0	0	0	0	1	0	-38
1	0	0	0	0	1	1	-39
1	0	0	0	1	0	0	-40
1	0	0	0	1	0	1	-41
1	0	0	0	1	1	0	-42
1	0	0	0	1	1	1	-43
1	0	0	1	0	0	0	-44
1	0	0	1	0	0	1	-45
1	0	0	1	0	1	0	-46
1	0	0	1	0	1	1	-47
1	0	0	1	1	0	0	-48
1	0	0	1	1	0	1	-49
1	0	0	1	1	1	0	-50
1	0	0	1	1	1	1	-51
1	0	1	0	0	0	0	-52
1	0	1	0	0	0	1	-53
1	0	1	0	0	1	0	-54
1	0	1	0	0	1	1	-55
1	0	1	0	1	0	0	-56
1	0	1	0	1	0	1	-57 ^[2]
1	0	1	0	1	1	0	-58 ^[2]
1	0	1	0	1	1	1	-59 ^[2]
1	0	1	1	0	0	0	-60 ^[2]
1	0	1	1	0	0	1	-61 ^[2]
1	0	1	1	0	1	0	-62 ^[2]
1	0	1	1	0	1	1	-63 ^[2]
1	0	1	1	1	0	0	-64 ^[2]
1	0	1	1	1	0	1	-65 ^[2]
1	0	1	1	1	1	0	-66 ^[2]
1	0	1	1	1	1	1	-67 ^[2]
1	1	0	0	0	0	0	-68 ^[2]
1	1	0	0	0	0	1	-69 ^[2]
1	1	0	0	0	1	0	-70 ^[2]
1	1	0	0	0	1	1	-71 ^[2]
1	1	0	0	1	0	0	-72 ^[2]
1	1	0	0	1	0	1	-73 ^[2]

Table 83. Volume setting ...continued

VOL6	VOL5	VOL4	VOL3	VOL2	VOL1	VOL0	Volume (dB)
1	1	0	0	1	1	0	-74 ^{[1][2]}
1	1	0	0	1	1	1	-75 ^{[1][2]}
1	1	0	1	0	0	0	-76 ^{[1][2]}
1	1	0	1	0	0	1	-77 ^{[1][2]}
1	1	0	1	0	1	0	-78 ^{[1][2]}
1	1	0	1	0	1	1	-79 ^{[1][2]}
1	1	0	1	1	0	0	-80 ^{[1][2]}
1	1	0	1	1	0	1	-81 ^{[1][2]}
1	1	0	1	1	1	0	-82 ^{[1][2]}
1	1	0	1	1	1	1	-83 ^{[1][2]}
1	1	1	0	0	0	0	-84 ^{[1][2]}
1	1	1	0	0	0	1	-85 ^{[1][2]}
1	1	1	0	0	1	0	-86 ^{[1][2]}
1	1	1	0	0	1	1	-87 ^{[1][2]}
1	1	1	0	1	0	0	-88 ^{[1][2]}
1	1	1	0	1	0	1	-89 ^{[1][2]}
1	1	1	0	1	1	0	-90 ^{[1][2]}
1	1	1	0	1	1	1	-91 ^{[1][2]}
1	1	1	1	0	0	0	-92 ^{[1][2]}
1	1	1	1	0	0	1	-93 ^{[1][2]}
1	1	1	1	0	1	0	-94 ^{[1][2]}
1	1	1	1	0	1	1	-95 ^{[1][2]}
1	1	1	1	1	0	0	-96 ^{[1][2]}
1	1	1	1	1	0	1	-97 ^{[1][2]}
1	1	1	1	1	1	0	-98 ^{[1][2]}
1	1	1	1	1	1	1	mute

[1] The overall gain is the sum of the input gain setting ING[3:0] and the volume setting VOL[6:0].

The overall gain has a range of +28 dB to -83 dB.

For $ING + VOL > 28$ dB the overall gain is 28 dB.

For $ING + VOL < -83$ dB the mute is active.

[2] For overall gain values below -75 dB ($ING + VOL < -75$ dB) the gain steps have a monotonous sequence.

The values of gain set error, gain step error and gain tracking error are not specified. The minimum gain value is determined by the mute value.

8.2.20 Write mode: data byte TREBLE

Table 84. TREBLE - format of data byte 12h with default setting

7	6	5	4	3	2	1	0
0	TRE2	TRE1	TRE0	TREM	TRF1	TRF0	0
	0	0	0	1	1	0	

Table 85. TREBLE - data byte 12h bit description

Bit	Symbol	Description
7	-	reserved; 0 = normal operation
6 to 4	TRE[2:0]	treble setting; treble amplification or gain setting; see Table 86 and Figure 37
3	TREM	treble control mode; treble control of attenuation or gain; see Table 86 0 = treble mode is set to attenuation 1 = treble mode is set to gain
2 and 1	TRF[1:0]	treble frequency 00 = 8 kHz 01 = 10 kHz 10 = 12 kHz 11 = 15 kHz
0	-	reserved; 0 = normal operation

Table 86. Treble control setting

TRE2	TRE1	TRE0	Treble control
TREM = 0			
0	0	0	0 dB
0	0	1	-2 dB
0	1	0	-4 dB
0	1	1	-6 dB
1	0	0	-8 dB
1	0	1	-10 dB
1	1	0	-12 dB
1	1	1	-14 dB
TREM = 1			
0	0	0	0 dB
0	0	1	2 dB
0	1	0	4 dB
0	1	1	6 dB
1	0	0	8 dB
1	0	1	10 dB
1	1	0	12 dB
1	1	1	14 dB

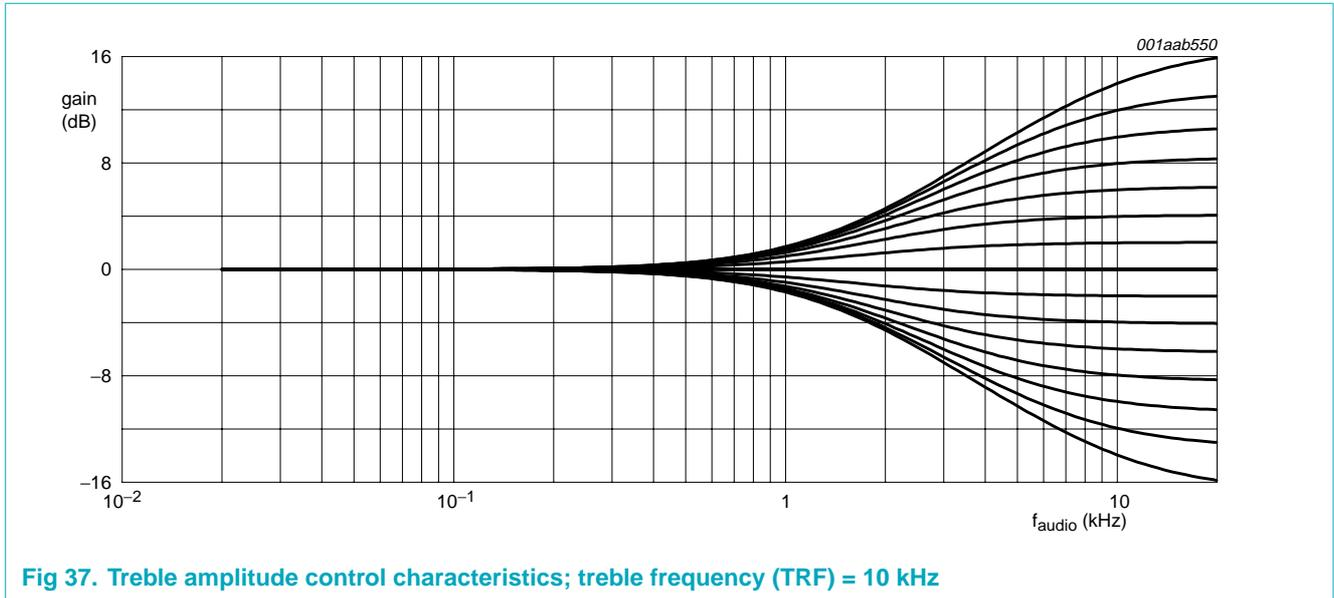

Fig 37. Treble amplitude control characteristics; treble frequency (TRF) = 10 kHz

8.2.21 Write mode: data byte BASS

Table 87. BASS - format of data byte 13h with default setting

7	6	5	4	3	2	1	0
BAS3	BAS2	BAS1	BAS0	BASM	BAF1	BAF0	0
0	0	0	0	1	1	0	

Table 88. BASS - data byte 13h bit description

Bit	Symbol	Description
7 to 4	BAS[3:0]	bass setting; bass amplification or gain setting; see Table 89 and Figure 38
3	BASM	bass control mode; bass control of attenuation or gain; see Table 89 0 = bass mode is set to attenuation 1 = bass mode is set to gain
2 and 1	BAF[1:0]	bass frequency 00 = 60 Hz 01 = 80 Hz 10 = 100 Hz 11 = 120 Hz
0	-	reserved; 0 = normal operation

Table 89. Bass control setting

BAS3	BAS2	BAS1	BAS0	Bass control
BASM = 0				
0	0	0	0	0 dB
0	0	0	1	-2 dB
0	0	1	0	-4 dB
0	0	1	1	-6 dB
0	1	0	0	-8 dB
0	1	0	1	-10 dB
0	1	1	0	-12 dB
0	1	1	1	-14 dB
1	0	0	1	-16 dB
1	0	1	0	-18 dB
1	0	1	1	-20 dB
BASM = 1				
0	0	0	0	0 dB
0	0	0	1	2 dB
0	0	1	0	4 dB
0	0	1	1	6 dB
0	1	0	0	8 dB
0	1	0	1	10 dB
0	1	1	0	12 dB
0	1	1	1	14 dB
1	0	0	1	16 dB
1	0	1	0	18 dB
1	0	1	1	20 dB

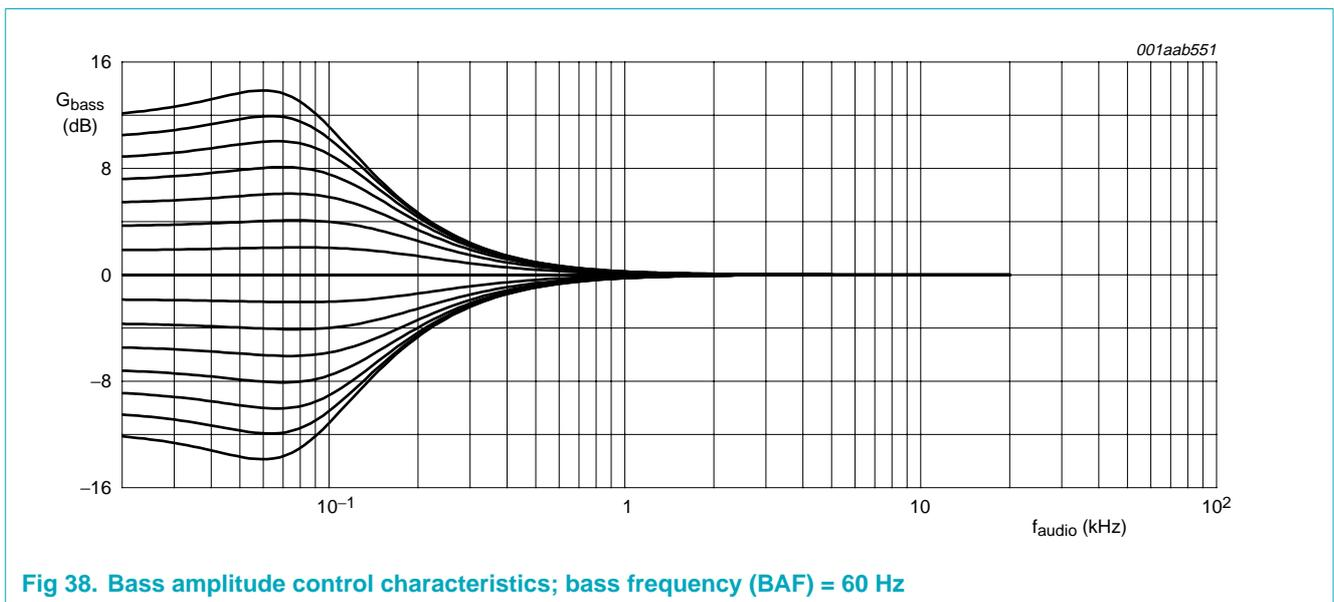

Fig 38. Bass amplitude control characteristics; bass frequency (BAF) = 60 Hz

8.2.22 Write mode: data byte FADER

Table 90. FADER - format of data byte 14h with default setting

7	6	5	4	3	2	1	0
FADM1	FADM0	FAD5	FAD4	FAD3	FAD2	FAD1	FAD0
0	0	0	0	0	0	0	0

Table 91. FADER - data byte 14h bit description

Bit	Symbol	Description
7 and 6	FADM[1:0]	fader mode; enable fader control for front or rear 00 = no fader; front output = 0 dB; rear output = 0 dB 01 = rear fader; front output = 0 dB; rear output = FAD[5:0] 10 = front fader; front output = FAD[5:0]; rear output = 0 dB 11 = output volume; front output = FAD[5:0]; rear output = FAD[5:0]
5 to 0	FAD[5:0]	Fader attenuation setting; 00 0000 to 11 1111 = -1 dB to -64 dB. For output mute control see data byte 15h; OUTPUT (see Table 92).

8.2.23 Write mode: data byte OUTPUT

Table 92. OUTPUT - format of data byte 15h with default setting

7	6	5	4	3	2	1	0
0	0	0	OUTA	MULF	MURF	MULR	MURR
			0	1	1	1	1

Table 93. OUTPUT - data byte 15h bit description

Bit	Symbol	Description
7 to 5	-	reserved; 0 = normal operation
4	OUTA	output gain 0 = standard output gain 1 = output gain is 3 dB
3	MULF	left front output mute 0 = output LFOUT is enabled 1 = output LFOUT is muted
2	MURF	right front output mute 0 = output RFOUT is enabled 1 = output RFOUT is muted
1	MULR	left rear output mute 0 = output LROUT is enabled 1 = output LROUT is muted
0	MURR	right rear output mute 0 = output RROUT is enabled 1 = output RROUT is muted

8.2.24 Write mode: data byte BALANCE

Table 94. BALANCE - format of data byte 16h with default setting

7	6	5	4	3	2	1	0
BALM	BAL6	BAL5	BAL4	BAL3	BAL2	BAL1	BAL0
1	0	0	0	0	0	0	0

Table 95. BALANCE - data byte 16h bit description

Bit	Symbol	Description
7	BALM	balance control mode; sets the balance mode to left or right attenuation 0 = left channel is attenuated 1 = right channel is attenuated
6 to 0	BAL[6:0]	balance setting; see Table 96

Table 96. Balance attenuation setting^[1]

BAL6	BAL5	BAL4	BAL3	BAL2	BAL1	BAL0	Balance (dB)
0	0	0	0	0	0	0	0
0	0	0	0	0	0	1	-1
:	:	:	:	:	:	:	:
1	1	0	1	1	1	0	-110
1	1	0	1	1	1	1	-111
1	1	1	0	0	0	0	mute

[1] The maximum obtainable attenuation of volume and balance is limited to -83 dB. For VOL + BAL attenuation settings below -83 dB; mute is activated.

8.2.25 Write mode: data byte LOUDNESS

Table 97. LOUDNESS - format of data byte 17h with default setting

7	6	5	4	3	2	1	0
AVUM	0	0	LDON	LDHB	LDS2	LDS1	LDS0
0			0	1	1	0	0

Table 98. LOUDNESS - data byte 17h bit description

Bit	Symbol	Description
7	AVUM	audio VU-meter mode ^[1] 0 = MOD read information indicates the modulation of the radio channel 1 and an external input source is selected = MOD read information will indicate the input amplitude of the selected source
6 and 5	-	reserved; 0 = normal operation
4	LDON	loudness on 0 = loudness control is disabled 1 = loudness control is active; loudness is controlled by the volume setting

Table 98. LOUDNESS - data byte 17h bit description ...continued

Bit	Symbol	Description
3	LDHB	loudness high boost; see Figure 39 0 = loudness control is limited to bass gain 1 = loudness controls bass gain and treble gain
2 to 0	LDS[2:0]	loudness start setting; loudness start defines the volume setting below which loudness control is activated; see Table 100 and Figure 39

[1] The VU-meter mode can be used with external sources only. When the VU-meter mode is active, the radio quality detection of USN, MOD and OFFS is limited to AF update tuning only. During VU-meter mode the bits MOD[4:0] indicate the external source input amplitude. The FM dynamic bandwidth control is disabled and a fixed bandwidth of 113 kHz is defined. However, other fixed bandwidth settings are available by DYN = 0 and the setting of BW; data byte 0h (see [Table 28](#)). See [Table 99](#) for compression recovery timing control. VU-meter mode is automatically activated when audio compression is on (COMP = 1).

Table 99. VU-meter timing; HTC[2:0] of data byte 0Bh; TIMING^[1]

HTC2	HTC1	HTC0	t _{attack}	t _{recovery}
0	0	0	0.02 s	0.03 s
0	0	1	0.02 s	0.06 s
0	1	0	0.02 s	0.2 s
0	1	1	0.02 s	5 s
1	0	0	0.02 s	0.6 s
1	0	1	0.02 s	10 s
1	1	0	0.02 s	1 s
1	1	1	0.02 s	2 s

[1] Setting HTC[2:0] is also in use for setting the timing of weak signal high cut control during radio operation.

Table 100. Loudness start

LDS2	LDS1	LDS0	Start of loudness at volume setting
0	0	0	-12 dB
0	0	1	-16 dB
0	1	0	-20 dB
0	1	1	-24 dB
1	0	0	-28 dB
1	0	1	-32 dB
1	1	0	-36 dB
1	1	1	-40 dB

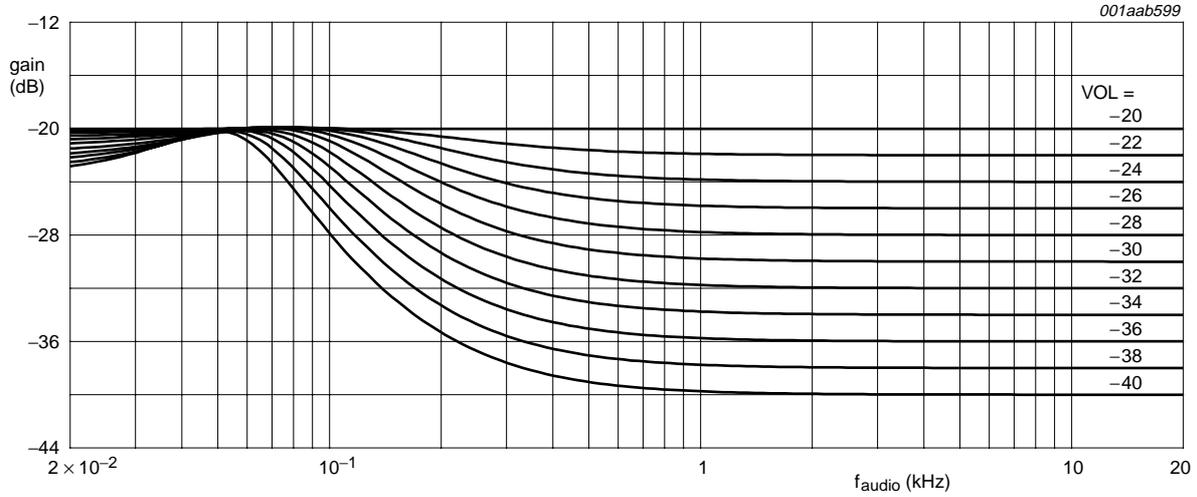

a. LDON = 1, LDHB = 0.

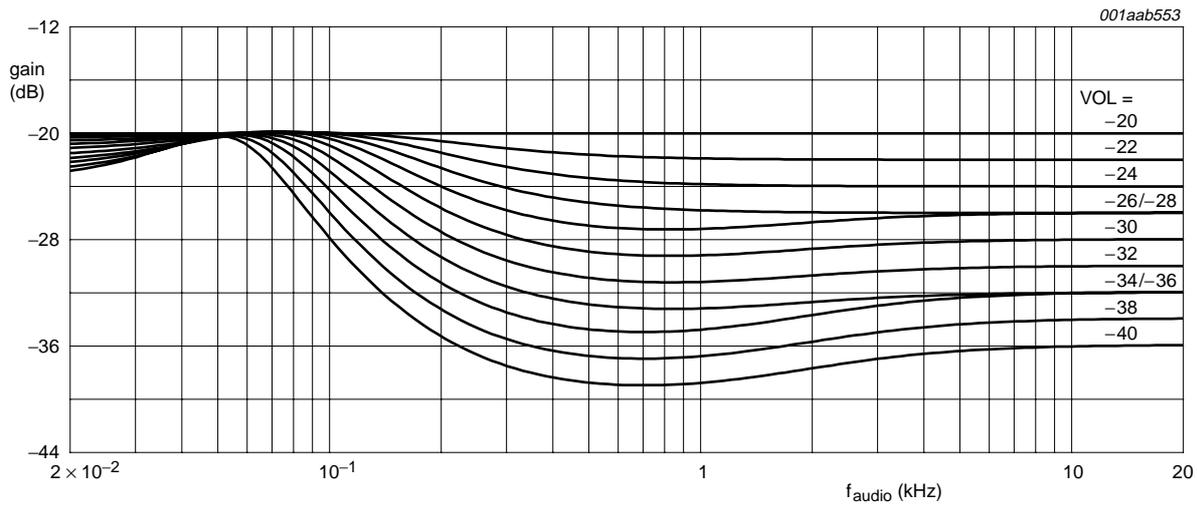

b. LDON = 1, LDHB = 1.

Fig 39. Loudness control characteristics; loudness start = -20 dB, bass frequency = 60 Hz, treble frequency = 10 kHz; bass gain = 0 dB, treble gain = 0 dB

8.2.26 Write mode: data byte POWER

Table 101. POWER - format of data byte 18h with default setting

7	6	5	4	3	2	1	0
0	STBT	STBR	0	0	ASI	AST1	AST0
	0	0			1	1	0

Table 102. POWER - data byte 18h bit description^[1]

Bit	Symbol	Description
7	-	reserved; 0 = normal operation
6	STBT	standby tuner 0 = normal operation 1 = power consumption is reduced by disabling part of the tuner circuit; radio operation is disabled
5	STBR	standby RDS demodulator 0 = normal operation 1 = RDS demodulator in Standby mode
4 and 3	-	reserved; 0 = normal operation
2	ASI	audio step interpolation 0 = audio step interpolation is disabled 1 = audio step interpolation is enabled
1 and 0	AST[1:0]	ASI step time; selection of the audio step interpolation time 00 = 1 ms 01 = 3 ms 10 = 10 ms 11 = 30 ms

[1] The power saving offered by the Standby modes is limited and is not intended to realize an effective power-down.

8.2.27 Write mode: data bytes RESERVED

Table 103. RESERVED - format of data byte 19h to 1Eh

7	6	5	4	3	2	1	0
0	0	0	0	0	0	0	0

Table 104. RESERVED - data byte 19h to 1Eh bit description^[1]

Bit	Symbol	Description
7 to 0	-	reserved; 0 = normal operation

[1] Reserved bits may control test options for factory testing.

8.2.28 Write mode: data byte TEST

Table 105. TEST - format of data byte 1Fh

7	6	5	4	3	2	1	0
RBWR	0	TEST5	TEST4	TEST3	TEST2	TEST1	TEST0
0		0	0	0	0	0	0

Table 106. TEST - data byte 1Fh bit description

Bit	Symbol	Description
7	RBWR	next I ² C-bus read contains write register data (RBWR will be reset to logic 0 after read)
6	-	reserved; 0 = normal operation
5 to 0	TEST[5:0]	test mode 00 0000 = normal operation 00 1011 = AM IF noise blanker disabled 00 1110 = AM IF noise blanker and AM audio noise blanker disabled 01 1001 = AM audio noise blanker and FM noise blanker disabled all other settings are reserved

9. Limiting values

Table 107. Limiting values

In accordance with the Absolute Maximum Rating System (IEC 60134).

Symbol	Parameter	Conditions	Min	Max	Unit
V _{CC}	analog supply voltage on pins VCC, VCCPLL, VCCVCO, VCCRF, AMMIX2OUT1, AMMIX2OUT2, MIX1OUT1 and MIX1OUT2		-0.3	+10	V
ΔV _{CC}	voltage difference between any VCC pins		-0.3	+0.3	V
V _{V60}	supply voltage for FM filter and demodulator		[1] -0.3	V _{CC} + 0.3	V
V _I	digital input voltage on pins SCL, SDA and ADDR		-0.3	+5.5	V
V _n	voltage on all other pins		[1] -0.3	V _{CC} + 0.3	V
T _{stg}	storage temperature		-40	+150	°C
T _j	junction temperature		-	150	°C
T _{amb}	ambient temperature		-40	+85	°C
V _{esd}	electrostatic discharge voltage on				
	all pins except VCCVCO	human body model	[2] -2000	+2000	V
		machine model	[3] -200	+200	V
	pin VCCVCO	human body model	[4] -1750	+1750	V
		machine model	[5] -175	+175	V

- [1] The maximum voltage should be less than 10 V.
- [2] Class 2 according to JESD22-A114C.01.
- [3] Class B according to EIA/JESD22-A115-A.
- [4] Class 1C according to JESD22-A114C.01.
- [5] Class A according to EIA/JESD22-A115-A.

10. Thermal characteristics

Table 108. Thermal characteristics

Symbol	Parameter	Conditions	Typ	Unit
$R_{th(j-a)}$	thermal resistance from junction to ambient	in free air	55	K/W
$R_{th(j-c)}$	thermal resistance from junction to case		18	K/W

11. Static characteristics

Table 109. Static characteristics

$V_{CC} = 8.5\text{ V}$; $T_{amb} = 25\text{ °C}$; unless otherwise specified.

Symbol	Parameter	Conditions	Min	Typ	Max	Unit
Supply voltage						
V_{CC}	analog supply voltage on pins VCC, VCCPLL, VCCVCO, VCCRF, AMMIX2OUT1, AMMIX2OUT2, MIX1OUT1 and MIX1OUT2		8	8.5	9	V
V_{V60}	supply voltage for FM filter and demodulator		5.5	7.2	-	V
Current in FM mode						
I_{CC}	supply current	$T_{amb} = -40\text{ °C}$	-	49	-	mA
		$T_{amb} = 25\text{ °C}$	40	49	60	mA
		$T_{amb} = 85\text{ °C}$	-	49	-	mA
I_{CCPLL}	supply current for tuning PLL	$T_{amb} = -40\text{ °C}$	-	4.0	-	mA
		$T_{amb} = 25\text{ °C}$	2.9	3.6	5	mA
		$T_{amb} = 85\text{ °C}$	-	3.3	-	mA
I_{CCVCO}	supply current for VCO	$T_{amb} = -40\text{ °C}$	-	2.2	-	mA
		$T_{amb} = 25\text{ °C}$	-	2.1	-	mA
		$T_{amb} = 85\text{ °C}$	-	2.0	-	mA
I_{CCRF}	supply current for RF	$T_{amb} = -40\text{ °C}$	-	12	16	mA
		$T_{amb} = 25\text{ °C}$	10.5	13.5	16.5	mA
		$T_{amb} = 85\text{ °C}$	-	14	18.5	mA
I_{V60}	supply current for FM filter and demodulator	$T_{amb} = -40\text{ °C}$	-	28	-	mA
		$T_{amb} = 25\text{ °C}$	22	28	34	mA
		$T_{amb} = 85\text{ °C}$	-	28	-	mA
$I_{MIX1OUT1};$ $I_{MIX1OUT2}$	bias current of FM and AM mixer 1 at output 1 or output 2	$T_{amb} = -40\text{ °C}$	-	5.3	-	mA
		$T_{amb} = 25\text{ °C}$	4.3	5.7	7.5	mA
		$T_{amb} = 85\text{ °C}$	-	6.0	8.0	mA
Current in AM mode						
I_{CC}	supply current	$T_{amb} = -40\text{ °C}$	-	58	-	mA
		$T_{amb} = 25\text{ °C}$	44	58	75	mA
		$T_{amb} = 85\text{ °C}$	-	58	-	mA

Table 109. Static characteristics ...continued

 $V_{CC} = 8.5\text{ V}$; $T_{amb} = 25\text{ °C}$; unless otherwise specified.

Symbol	Parameter	Conditions	Min	Typ	Max	Unit
I_{CCPLL}	supply current for tuning PLL	$T_{amb} = -40\text{ °C}$	-	3.9	-	mA
		$T_{amb} = 25\text{ °C}$	2.9	3.6	5	mA
		$T_{amb} = 85\text{ °C}$	-	3.2	-	mA
I_{CCVCO}	supply current for VCO	$T_{amb} = -40\text{ °C}$	-	2.2	-	mA
		$T_{amb} = 25\text{ °C}$	-	2.1	-	mA
		$T_{amb} = 85\text{ °C}$	-	2.0	-	mA
I_{CCRF}	supply current for RF	$T_{amb} = -40\text{ °C}$	-	8.8	-	mA
		$T_{amb} = 25\text{ °C}$	6.7	8.8	13	mA
		$T_{amb} = 85\text{ °C}$	-	8.8	-	mA
I_{V60}	supply current for FM filter and demodulator	$T_{amb} = -40\text{ °C}$	-	8.0	-	mA
		$T_{amb} = 25\text{ °C}$	6	7.8	10.2	mA
		$T_{amb} = 85\text{ °C}$	-	7.5	-	mA
$I_{MIX1OUT1}$; $I_{MIX1OUT2}$	bias current of FM and AM mixer 1 at output 1 or output 2	$T_{amb} = -40\text{ °C}$	-	3.6	-	mA
		$T_{amb} = 25\text{ °C}$	2.6	3.45	4.5	mA
		$T_{amb} = 85\text{ °C}$	-	3.3	-	mA
$I_{AMMIX2OUT1}$; $I_{AMMIX2OUT2}$	bias current of AM mixer 2 at output 1 or output 2	$T_{amb} = -40\text{ °C}$	-	5.5	-	mA
		$T_{amb} = 25\text{ °C}$	3.7	4.6	5.5	mA
		$T_{amb} = 85\text{ °C}$	-	3.7	-	mA

Logic pins

V_{IH}	HIGH-level input voltage (pins RDCL and ADDR)		1.75	-	5.5	V
V_{IL}	LOW-level input voltage (pins RDCL and ADDR)		-0.2	-	+1.0	V
$I_{leak(od)}$	open-drain leakage current (pins RDCL and RDDA)		-10	-	+10	μA
V_{OL}	LOW-level output voltage (pins RDCL and RDDA)	open collector; $I_{OL} = 3\text{ mA}$	-	-	0.4	V

Power-on reset; all registers in default setting, outputs muted, Standby mode

$V_{th(POR)}$	threshold value of V_{CC} for power-on reset	V_{CC} drop during operation				
		$T_{amb} = -40\text{ °C}$	-	6.8	-	V
		$T_{amb} = 25\text{ °C}$	6.15	6.3	6.45	V
		$T_{amb} = 85\text{ °C}$	-	5.8	-	V

12. Dynamic characteristics

12.1 Dynamic characteristics of the tuner

Table 110. Dynamic characteristics of the tuner

$V_{CC} = 8.5\text{ V}$; $T_{amb} = 25\text{ °C}$; see [Figure 43](#); all AC values are given in RMS; unless otherwise specified.

Symbol	Parameter	Conditions	Min	Typ	Max	Unit
Crystal oscillator						
f_{xtal}	crystal frequency		-	20.5	-	MHz
C/N	carrier-to-noise ratio	$f_{xtal} = 20.5\text{ MHz}$; $\Delta f = 10\text{ kHz}$	112	-	-	$\frac{\text{dBc}}{\sqrt{\text{Hz}}}$
Circuit inputs: pins XTAL1 and XTAL2						
$V_{o(osc)(rms)}$	oscillator output voltage (RMS value)		[1] 80	100	160	mV
R_i	real part of input impedance	$V_{XTAL1-XTAL2} = 1\text{ mV}$	[1] -	-500	-250	Ω
C_i	input capacitance		[1] -	8	-	pF
Tuning system; see Table 38, Table 39 and Table 41						
Voltage controlled oscillator						
$f_{osc(min)}$	minimum oscillator frequency		-	-	153.6	MHz
$f_{osc(max)}$	maximum oscillator frequency		256	-	-	MHz
C/N	carrier-to-noise ratio	$f_{osc} = 200\text{ MHz}$; $\Delta f = 10\text{ kHz}$; $Q \geq 30$	-	98	-	$\frac{\text{dBc}}{\sqrt{\text{Hz}}}$
RR	ripple rejection; $RR = \frac{V_{CC(ripple)}}{V_{MPXAM}}$	$f_{ripple} = 100\text{ Hz}$; $V_{CC(ripple)} = 50\text{ mV (RMS)}$; $f_{osc} = 200\text{ MHz}$; FM mode	44	50	-	dB
Charge pump: pin CPOUT; see Table 40						
$I_{sink(CP1)}$	charge pump CP1 sink current	$V_{CPOUT} = 0.5\text{ V}$ to $V_{CCPLL} - 1.3\text{ V}$; $f_{ref} = 100\text{ kHz}$	130	180	240	μA
$I_{source(CP1)}$	charge pump CP1 source current	$V_{CPOUT} = 0.5\text{ V}$ to $V_{CCPLL} - 1.3\text{ V}$; $f_{ref} = 100\text{ kHz}$	-240	-180	-130	μA
$I_{sink(CP2)}$	charge pump CP2 sink current	$V_{CPOUT} = 0.7\text{ V}$ to $V_{CCPLL} - 1.5\text{ V}$; $f_{ref} = 50\text{ kHz}$	270	360	480	μA
$I_{source(CP2)}$	charge pump CP2 source current	$V_{CPOUT} = 0.7\text{ V}$ to $V_{CCPLL} - 1.5\text{ V}$; $f_{ref} = 50\text{ kHz}$	-480	-360	-270	μA
$I_{sink(CP3)}$	charge pump CP3 sink current	$V_{CPOUT} = 0.7\text{ V}$ to $V_{CCPLL} - 0.7\text{ V}$; $f_{ref} = 20\text{ kHz}$ or 25 kHz	580	780	1050	μA
$I_{source(CP3)}$	charge pump CP3 source current	$V_{CPOUT} = 0.7\text{ V}$ to $V_{CCPLL} - 0.7\text{ V}$; $f_{ref} = 20\text{ kHz}$ or 25 kHz	-1050	-780	-580	μA
$I_{sink(CP4)}$	charge pump CP4 sink current	$V_{CPOUT} = 0.7\text{ V}$ to $V_{CCPLL} - 0.7\text{ V}$; $f_{ref} = 20\text{ kHz}$	1040	1400	1900	μA
$I_{source(CP4)}$	charge pump CP4 source current	$V_{CPOUT} = 0.7\text{ V}$ to $V_{CCPLL} - 0.7\text{ V}$; $f_{ref} = 20\text{ kHz}$	-1900	-1400	-1040	μA

Table 110. Dynamic characteristics of the tuner ...continued

$V_{CC} = 8.5\text{ V}$; $T_{amb} = 25\text{ °C}$; see [Figure 43](#); all AC values are given in RMS; unless otherwise specified.

Symbol	Parameter	Conditions	Min	Typ	Max	Unit
$I_{\text{sink(}CP5)}$	charge pump CP5 sink current	$V_{CP\text{OUT}} = 0.7\text{ V}$ to $V_{CCPLL} - 0.7\text{ V}$; $f_{\text{ref}} = 10\text{ kHz}$	1630	2200	2970	μA
$I_{\text{source(}CP5)}$	charge pump CP5 source current	$V_{CP\text{OUT}} = 0.7\text{ V}$ to $V_{CCPLL} - 0.7\text{ V}$; $f_{\text{ref}} = 10\text{ kHz}$	-2970	-2200	-1630	μA

Charge pump: pin VTUNE

I_{sink}	charge pump sink current	$V_{VTUNE} = 0.8\text{ V}$ to $V_{CCPLL} - 0.7\text{ V}$	2070	2800	3780	μA
I_{source}	charge pump source current	$V_{VTUNE} = 0.8\text{ V}$ to $V_{CCPLL} - 0.7\text{ V}$	-3780	-2800	-2070	μA
t_{tune}	tuning time	Europe FM and US FM band; $f_{\text{ref}} = 100\text{ kHz}$; $f_{RF} = 87.5\text{ MHz}$ to 108 MHz	-	0.75	1	ms
		AM MW band; $f_{\text{ref}} = 20\text{ kHz}$; $f_{RF} = 0.53\text{ MHz}$ to 1.7 MHz	-	5	20	ms
T_{cy}	inaudible AF update cycle time including 1 ms mute start and 1 ms mute release time		-	6	6.5	ms

Antenna Digital Auto Alignment (DAA)

DAA: pin DAAOUT^[2]

$I_{\text{leak(DAA)}}$	antenna DAA input leakage current on pin VTUNE (test mode)	$V_{VTUNE} = 0.4\text{ V}$ to 8 V	-10	-	+10	nA
$\Delta V_{o(T)}$	output voltage variation with temperature	$T_{amb} = -40\text{ °C}$ to $+85\text{ °C}$; $DAA[6:0] = 100\ 0000$	-30	-	+30	mV
$\Delta V_{o(\text{sink})}$	output voltage variation caused by sink current	$V_{VTUNE} = 4\text{ V}$; $I_L = 50\ \mu\text{A}$	$-V_{\text{LSB}}$	-	$+V_{\text{LSB}}$	
$\Delta V_{o(\text{source})}$	output voltage variation caused by source current	$V_{VTUNE} = 4\text{ V}$; $I_L = -50\ \mu\text{A}$	$-V_{\text{LSB}}$	-	$+V_{\text{LSB}}$	
t_{st}	settling time	$V_{DAA\text{OUT}} = 0.2\text{ V}$ to 8.25 V ; $C_L = 270\text{ pF}$	-	30	60	μs

AM mode

V_o	output voltage	$DAA[6:0] = 000\ 0000$	-	-	0.5	V
		$DAA[6:0] = 111\ 1111$	8.0	-	8.5	V

FM mode

$V_{o(n)}$	output noise voltage	$V_{VTUNE} = 4\text{ V}$; $DAA[6:0] = 100\ 0000$; $B = 300\text{ Hz}$ to 22 kHz	-	30	100	μV
RR	ripple rejection	$V_{VTUNE} = 4\text{ V}$; $DAA[6:0] = 101\ 0101$; $f_{\text{ripple}} = 100\text{ Hz}$; $V_{CC(\text{ripple})} = 100\text{ mV}$	-	40	-	dB
$\Delta V_{o(\text{step})}$	step accuracy	$V_{VTUNE} = 2\text{ V}$	$-0.5V_{\text{LSB}}$	0	$+0.5V_{\text{LSB}}$	

Table 110. Dynamic characteristics of the tuner ...continued

 $V_{CC} = 8.5\text{ V}$; $T_{amb} = 25\text{ }^{\circ}\text{C}$; see [Figure 43](#); all AC values are given in RMS; unless otherwise specified.

Symbol	Parameter	Conditions	Min	Typ	Max	Unit
V_o	output voltage	$V_{VTUNE} = 0.5\text{ V}$; $DAA[6:0] = 000\ 0000$	-	-	0.5	V
		$V_{VTUNE} = 4.25\text{ V}$; $DAA[6:0] = 111\ 1111$	8	-	-	V
		$V_{VTUNE} = 4\text{ V}$				
		$DAA[6:0] = 000\ 0000$	-	-	0.5	V
		$DAA[6:0] = 100\ 0000$	3.8	4.23	4.65	V
		$V_{VTUNE} = 2\text{ V}$				
		$DAA[6:0] = 101\ 0101$	2.45	2.74	3.05	V
	$DAA[6:0] = 010\ 1010$	1.3	1.46	1.6	V	

AM channelAM RF AGC detector A: pin AMMIX1IN; see [Figure 40](#)

$V_{AMMIX1IN(p-p)}$	AM AGC start level (peak-to-peak value)	$AGC[1:0] = 00$; $m = 1$	700	1000	1400	mV
---------------------	---	---------------------------	-----	------	------	----

AM RF AGC detector B: pin AMIF2IN; see [Figure 40](#)

$V_{AMIF2IN(p-p)}$	IF voltage on pin AMIF2IN for AGC start (peak-to-peak value)	$m = 1$; $f_{mod} = 400\text{ Hz}$	-	0.23	-	V
--------------------	--	-------------------------------------	---	------	---	---

RF cascode AGC

ΔAGC	AGC control range		-	10	-	dB
V_{VAMCAS}	cascode base voltage	$AGC[1:0] = 00$; maximum gain at cascode AGC	-	5	-	V
R_{VAMCAS}	cascode base source resistance		-	1.6	-	k Ω
I_{VAMCAS}	cascode base current drive capability	source current	100	-	-	μA
		sink current	-	0	-	μA
$V_{VAMCASFB}$	cascode emitter DC voltage	minimum gain at cascode AGC	-	320	-	mV
		maximum gain at cascode AGC				
		$KAGC = 1$	-	800	-	mV
		$KAGC = 0$	-	4.15	-	V
$I_{VAMCASFB}$	cascode feedback current		-	-	2	μA

RF PIN diode AGC current generator output: pin IAMAGC

ΔAGC	AGC control range	$f_{RF} = 999\text{ kHz}$; dummy aerial 15 pF/60 pF	-	50	-	dB
$I_{sink(max)}$	maximum AGC sink current	$V_{IAMAGC} > 1\text{ V}$	10	-	-	mA
I_{source}	AGC source current	AGC not active	-	-2.5	-	μA
$I_{sink(FM)}$	AGC sink current in FM mode	$AGCSW = 1$	0.5	1	-	mA
		$AGCSW = 0$	-	-	100	nA

Table 110. Dynamic characteristics of the tuner ...continued

 $V_{CC} = 8.5\text{ V}$; $T_{amb} = 25\text{ °C}$; see Figure 43; all AC values are given in RMS; unless otherwise specified.

Symbol	Parameter	Conditions	Min	Typ	Max	Unit
C_{IAMAGC}	source current generator output capacitance		-	3	-	pF
V_{VDCPIN}	bias voltage for AM PIN diode		4.5	5	5.5	V
R_{VDCPIN}	bias source resistance		-	150	-	Ω
$I_{bias(max)}$	maximum bias current	source current	20	-	-	mA
		sink current	30	-	-	μA

AM mixer 1 (IF1 = 10.7 MHz)

Mixer input: pins AMMIX1IN and AMMIX1DEC

R_i	input resistance		[3] 10	13.2	16	k Ω
C_i	input capacitance		[3] -	3	-	pF
$V_{i(max)}$	maximum input voltage	1 dB compression point of $V_{MIX1OUT1-MIX1OUT2}$; $m = 0$	500	-	-	mV

Mixer output: pins MIX1OUT1 and MIX1OUT2

$V_{o(max)(p-p)}$	maximum output voltage (peak-to-peak value)		-	12	-	V
$g_{m(conv)}$	conversion transconductance I_o/V_i		1.75	2.5	3.25	$\frac{\text{mA}}{\text{V}}$
$g_{m(conv)(T)}$	conversion transconductance variation with temperature related to $T_{amb} = 25\text{ °C}$	$T_{amb} = -40\text{ °C}$	-	1	-	dB
		$T_{amb} = 85\text{ °C}$	-	-0.2	-	dB
R_o	output resistance		[4] 100	-	-	k Ω
C_o	output capacitance		[4] -	4	7	pF
IP3	3rd-order intercept point	$R_L = 2.6\text{ k}\Omega$ (AC load between output pins); $\Delta f = 300\text{ kHz}$	135	138	-	dB μV
IP2	2nd-order intercept point	$R_L = 2.6\text{ k}\Omega$ (AC load between output pins)	-	170	-	dB μV
$V_{i(n)(eq)}$	equivalent input noise voltage	band limited noise; $R_{gen} = 750\text{ }\Omega$; noise of R_{gen} included; $R_L = 2.6\text{ k}\Omega$ (AC load between output pins)	-	5.8	8	$\frac{\text{nV}}{\sqrt{\text{Hz}}}$
F	noise figure of AM mixer 1		-	4.5	7.1	dB

AM mixer 2 (IF2 = 450 kHz)

Mixer input: pins IF1IN and IF1DEC

R_i	input resistance		[5] -	330	-	Ω
C_i	input capacitance		[5] -	3	-	pF
$V_{i(max)(p)}$	maximum input voltage (peak value)	1 dB compression point of $V_{AMMIX2OUT1-AMMIX2OUT2}$	1.1	1.4	-	V

Mixer output: pins AMMIX2OUT1 and AMMIX2OUT2

R_o	output resistance		[6] 50	-	-	k Ω
-------	-------------------	--	--------	---	---	------------

Table 110. Dynamic characteristics of the tuner ...continued $V_{CC} = 8.5\text{ V}$; $T_{amb} = 25\text{ °C}$; see [Figure 43](#); all AC values are given in RMS; unless otherwise specified.

Symbol	Parameter	Conditions	Min	Typ	Max	Unit
C_o	output capacitance		[6] -	3	-	pF
$V_{o(max)(p-p)}$	maximum output voltage (peak-to-peak value)	$V_{CCAMMIX2} = 8.5\text{ V}$	-	12	-	V
$g_{m(conv)}$	conversion transconductance I_o/V_i		1.2	1.6	2.1	$\frac{mA}{V}$
$g_{m(conv)(T)}$	conversion transconductance variation with temperature related to $T_{amb} = 25\text{ °C}$	$T_{amb} = -40\text{ °C to }+85\text{ °C}$	-1	0	+1	dB
IP3	3rd-order intercept point	$R_L = 1.5\text{ k}\Omega$ (AC load between output pins); $\Delta f = 300\text{ kHz}$	134	137	-	dB μ V
IP2	2nd-order intercept point	$R_L = 1.5\text{ k}\Omega$ (AC load between output pins)	-	170	-	dB μ V
$V_{i(n)(eq)}$	equivalent input noise voltage	$R_{gen} = 330\text{ }\Omega$; noise of R_{gen} included; $R_L = 1.5\text{ k}\Omega$ (AC load between output pins)	-	15	22	$\frac{nV}{\sqrt{Hz}}$
F	noise figure of AM mixer 2		-	16	19.5	dB
I_{leak}	mixer leakage current	FM mode; $T_{amb} = -40\text{ °C to }+85\text{ °C}$	-	-	10	μ A
AM IF2 AGC stage: pins AMIF2IN and AMIF2DEC[5]						
R_i	input resistance		1.6	2	2.4	k Ω
C_i	input capacitance		-	5	-	pF
V_i	input voltage	for $\alpha = -10\text{ dB}$ audio attenuation at MPXAMOUT	-	10	20	μ V
$V_{AGC(stop)}$	AGC stop voltage (input carrier voltage)		100	-	-	mV
AM demodulator output: pin MPXAMOUT						
V_{sens}	sensitivity voltage	$m = 0.3$; $f_{mod} = 400\text{ Hz}$; $B_{AF} = 2.15\text{ kHz}$; $R_{gen} = 2\text{ k}\Omega$				
		(S+N)/N = 26 dB	-	60	90	μ V
		(S+N)/N = 46 dB	-	600	900	μ V
(S+N)/N	maximum signal plus noise-to-noise ratio	$m = 0.3$; $f_{mod} = 400\text{ Hz}$; $B_{AF} = 2.15\text{ kHz}$; $R_{gen} = 2\text{ k}\Omega$	54	60	-	dB
V_o	MPXAMOUT output voltage	$m = 0.3$; $f_{mod} = 400\text{ Hz}$; $V_i = 100\text{ }\mu$ V to 100 mV	200	255	320	mV
THD	total harmonic distortion	$B_{AF} = 2.15\text{ kHz}$; $V_{AMIF2IN} = 100\text{ }\mu$ V to 100 mV; $m = 0.8$; $f_{mod} = 400\text{ Hz}$	-	0.5	1	%
t_{st}	AM AGC settling time	$V_{AMIF2IN} = 100\text{ }\mu$ V to 100 mV	-	165	-	ms
		$V_{AMIF2IN} = 100\text{ mV to }100\text{ }\mu$ V	-	440	-	ms
R_o	output resistance		-	-	500	Ω
C_o	output capacitance		-	3	-	pF
Z_L	load impedance		10	-	-	k Ω

Table 110. Dynamic characteristics of the tuner ...continued

$V_{CC} = 8.5\text{ V}$; $T_{amb} = 25\text{ °C}$; see [Figure 43](#); all AC values are given in RMS; unless otherwise specified.

Symbol	Parameter	Conditions	Min	Typ	Max	Unit
RR	ripple rejection $RR = \frac{V_{CC(ripple)}}{V_{MPXAMOUT}}$	$f_{ripple} = 100\text{ Hz}$; $V_{CC(ripple)} = 50\text{ mV (RMS)}$; $V_{AMIF2IN} = 10\text{ mV}$	20	26	-	dB
AM level detector output: pin LEVEL						
<i>Input: pins AMIF2IN and AMIF2DEC</i>						
LST	level start alignment position	$V_{i(AMIF2IN)} = 95\text{ }\mu\text{V}$; level slope aligned to (800 ± 50) mV/20 dB; level start aligned to $V_{LEVEL} = (1.24 \pm 0.04)\text{ V}$	6	-	25	-
ΔV_{LEVEL}	step size for adjustment of level starting point	$V_{AMIF2IN} = 0\text{ V}$; default setting of level slope	20	40	72	mV
LSL	level slope alignment position	level slope measured from $V_{i(AMIF2IN)} = 95\text{ }\mu\text{V}$ to $V_{i(AMIF2IN)} = 950\text{ }\mu\text{V}$; level slope aligned to (800 ± 50) mV/20 dB	0	-	7	-
ΔV_{step}	step size for adjustment of level slope	$V_{AMIF2IN} = 1.4\text{ mV}$	40	60	80	$\frac{\text{mV}}{20\text{ dB}}$
$\Delta V_{LEVEL(T)}$	level voltage drift over temperature	$T_{amb} = -40\text{ °C to }+85\text{ °C}$	-	0.05	-	$\frac{\text{dB}}{\text{K}}$
R_o	output resistance		-	-	500	Ω
R_L	output load resistance		25	-	-	k Ω
$C_{L(max)}$	maximum load capacitance		25	-	-	pF
RR	ripple rejection $RR = \frac{V_{CC(ripple)}}{V_{LEVEL(AC)}}$	$V_{CC(ripple)} = 50\text{ mV (RMS)}$; $f_{ripple} = 100\text{ Hz}$; $V_{AMIF2IN} = 10\text{ mV}$	-	24	-	dB
AM noise blanker IF part						
t_{sup}	suppression time at IF2	IF2 = 450 kHz	-	8	-	μs
V_{th}	noise blanker trigger threshold	noise pulse at RF input (CISPR 16-1); repetition rate = 100 Hz; pulse duration 5 ns; t_r and $t_f < 1\text{ ns}$; measured at dummy aerial input (15 pF/60 pF)				
		NBL[1:0] = 00	-	1.4	-	V
		NBL[1:0] = 01	-	1.0	-	V
		NBL[1:0] = 10	-	0.7	-	V
m_{th}	modulation threshold for blanking of audio signal	maximum modulation, which triggers the blanking circuit in the audio part; LODX = 0	-	5	-	%

Table 110. Dynamic characteristics of the tuner ...continued

 $V_{CC} = 8.5\text{ V}$; $T_{amb} = 25\text{ °C}$; see [Figure 43](#); all AC values are given in RMS; unless otherwise specified.

Symbol	Parameter	Conditions	Min	Typ	Max	Unit
FM channel						
FM RF AGC (FM distance mode; LODX = 0)						
Inputs: pins FMMIX1IN1 and FMMIX1IN2 ^[7]						
$V_{i(RF)}$	RF input voltage for start of wideband AGC	AGC[1:0] = 11	-	9	-	mV
PIN diode drive output: pin IFMAGC						
$I_{source(max)}$	maximum AGC source current	AGC[1:0] = 00; KAGC = 0; $V_{i(RF)} > V_{AGC(start)}$; see Table 34	-15	-10	-7	mA
$I_{sink(max)}$	maximum AGC sink current at AGC recovery	AGC[1:0] = 00; KAGC = 0	7	10	15	mA
I_{source}	AGC source current	AM mode; AGCSW = 1	-6	-4	-2.5	mA
		AM mode; AGCSW = 0	-	0	-	mA
		LODX = 1 (FM local)	-0.75	-0.5	-0.35	mA
Voltage for narrow-band AGC: pin LEVEL						
V_{th}	threshold voltage for narrow-band AGC	KAGC = 1 (keyed AGC)	500	950	1400	mV
FM mixer 1 (IF1 = 10.7 MHz)						
Mixer input: pins FMMIX1IN1 and FMMIX1IN2 ^[7] and mixer output: pins MIX1OUT1 and MIX1OUT2 ^[4]						
R_i	input resistance	RFGAIN = 0	3	3.8	4.7	k Ω
		RFGAIN = 1	1.6	2.0	2.5	k Ω
C_i	input capacitance		-	2	4	pF
R_o	output resistance		100	-	-	k Ω
C_o	output capacitance		-	4	6	pF
$V_{i(RF)(max)}$	maximum RF input voltage	1 dB compression point of FM mixer output voltage	75	100	-	mV
$V_{i(n)(eq)}$	equivalent input noise voltage	$R_{gen} = 200\ \Omega$; noise of R_{gen} included; $R_L = 2.6\text{ k}\Omega$	-	2.7	3.2	$\frac{nV}{\sqrt{Hz}}$
$g_{m(conv)}$	conversion transconductance I_o/V_i	RFGAIN = 0	12	18	25	$\frac{mA}{V}$
		RFGAIN = 1	24	36	50	$\frac{mA}{V}$
$g_{m(conv)(T)}$	conversion transconductance variation with temperature		-	-0.2×10^{-2}	-	K ⁻¹
F	noise figure	$R_{gen} = 300\ \Omega$				
		$T_{amb} = -40\text{ °C}$	-	2.8	-	dB
		$T_{amb} = 25\text{ °C}$	-	3.1	4.6	dB
		$T_{amb} = 85\text{ °C}$	-	3.5	-	dB
R_{gen}	recommended generator resistance		-	200	-	Ω
IP3	3rd-order intercept point	RFGAIN = 0	-	120	-	dB μ V

Table 110. Dynamic characteristics of the tuner ...continued

 $V_{CC} = 8.5\text{ V}$; $T_{amb} = 25\text{ }^{\circ}\text{C}$; see Figure 43; all AC values are given in RMS; unless otherwise specified.

Symbol	Parameter	Conditions	Min	Typ	Max	Unit
IRR	image rejection ratio $\frac{V_{\text{owanted}}}{V_{\text{oimage}}}$	$f_{\text{RFwanted}} = 87.5\text{ MHz}$; $f_{\text{RFimage}} = 108.9\text{ MHz}$	25	35	-	dB
$V_{\text{o(max)(p-p)}}$	maximum output voltage (peak-to-peak value)		4.5	5.6	-	V

FM filter and demodulator**Tunable filter**

B_{max}	maximum bandwidth	DYN = 1	-	165	-	kHz
		DYN = 0	-	165	-	kHz
B_{min}	minimum bandwidth	DYN = 1	-	57	-	kHz
		DYN = 0	-	57	-	kHz
Δf_{IF2}	FM IF2 center frequency alignment step size		-	2	-	kHz
$f_{\text{IF2(T)}}$	temperature dependence of IF2 center frequency		-60	-	+60	$\frac{\text{Hz}}{\text{K}}$

FM demodulator*FM mixer 2 input: pins IF1IN and IF1DEC[5] and output: pin MPXAMOUT*

R_i	input resistance		275	330	400	Ω
R_o	output resistance		-	-	500	Ω
R_L	load resistance		20	-	-	k Ω
C_L	load capacitance		-	-	20	pF
$V_{i(\text{max})}$	maximum input voltage		-	280	-	mV
$V_{i(\text{start})(\text{lim})}$	input voltage for start of limiting of V_{MPXAMOUT}	$\alpha_{\text{AF}} = -3\text{ dB}$	-	2.3	-	μV
$V_{i(\text{sens})}$	sensitivity input voltage	$\Delta f = 22.5\text{ kHz}$; $f_{\text{mod}} = 1\text{ kHz}$; de-emphasis = 50 μs	-	5	-	μV
		(S+N)/N = 26 dB; $R_{\text{gen}} = 330\ \Omega$	-	41	-	μV
		(S+N)/N = 46 dB	-	41	-	μV
(S+N)/N	ultimate signal plus noise-to-noise ratio on pin MPXAMOUT	$\Delta f = 22.5\text{ kHz}$; $f_{\text{mod}} = 1\text{ kHz}$; $V_i = 3\text{ mV}$; de-emphasis = 50 μs ; B = 300 Hz to 22 kHz	75	78	-	dB
THD	total harmonic distortion of V_{MPXAMOUT}	$\Delta f = 75\text{ kHz}$; $f_{\text{mod}} = 1\text{ kHz}$; $V_i = 10\text{ mV}$	-	0.5	1	%
Δf_{max}	maximum FM deviation	THD = 3 %; $f_{\text{mod}} = 1\text{ kHz}$; $V_i = 10\text{ mV}$	120	180	-	kHz
α_{AM}	AM suppression $\frac{V_{\text{MPXAMOUT(FM)}}}{V_{\text{MPXAMOUT(AM)}}$	FM reference: $\Delta f = 22.5\text{ kHz}$; $f_{\text{mod}} = 1\text{ kHz}$; AM: $m = 0.3$; $f_{\text{mod}} = 1\text{ kHz}$; de-emphasis = 50 μs	-	40	-	dB
		$10\ \mu\text{V} < V_i < 1\text{ V}$	-	50	-	dB
		$100\ \mu\text{V} < V_i < 1\text{ V}$	-	50	-	dB

Table 110. Dynamic characteristics of the tuner ...continued $V_{CC} = 8.5\text{ V}$; $T_{amb} = 25\text{ }^\circ\text{C}$; see [Figure 43](#); all AC values are given in RMS; unless otherwise specified.

Symbol	Parameter	Conditions	Min	Typ	Max	Unit
V_o	output voltage	$V_i = 20\text{ }\mu\text{V}$ to 1 V		[4]		
		$\Delta f = 1.2\text{ kHz}$; $f_{mod} = 57\text{ kHz}$	-	7	-	mV
		$\Delta f = 22.5\text{ kHz}$; $f_{mod} = 1\text{ kHz}$	180	230	290	mV
f_{cut}	cut-off frequency	$C_L = 0\text{ F}$; $R_L > 20\text{ k}\Omega$	-	65	-	kHz
RR	ripple rejection	$f_{ripple} = 100\text{ Hz}$ to 20 kHz; $V_{CC(ripple)} = 50\text{ mV}$; $V_{IF1IN} = 3\text{ mV}$	-	36	-	dB
	$RR = \frac{V_{CC(ripple)}}{V_{MPXAMOUT}}$					

FM level detector output: pin LEVEL[5]

R_o	output resistance		-	-	500	Ω
R_L	load resistance		25	-	-	k Ω
C_L	load capacitance		-	-	25	pF
LST	level start alignment position	$V_{i(IF1IN)} = 135\text{ }\mu\text{V}$; level slope aligned to $(800 \pm 50)\text{ mV/20 dB}$; level start aligned to $V_{LEVEL} = (1.47 \pm 0.04)\text{ V}$	6	-	25	-
ΔV_{LEVEL}	step size of level start adjustment	LSL[2:0] = 100	20	40	72	mV
LSL	level slope alignment position	level slope measured from $V_{i(IF1IN)} = 135\text{ }\mu\text{V}$ to $V_{i(IF1IN)} = 1.35\text{ mV}$; level slope aligned to $(800 \pm 50)\text{ mV/20 dB}$	0	-	7	-
ΔV_{step}	step size of level slope adjustment	$V_i = 1\text{ mV}$	40	60	80	$\frac{\text{mV}}{20\text{ dB}}$
RR	ripple rejection	$V_{CC(ripple)} = 50\text{ mV}$; $f_{ripple} = 100\text{ Hz}$	-	25	-	dB
	$RR = \frac{V_{CC(ripple)}}{V_{level(AC)}}$					

IF counter (FM IF2 or AM IF2 counter); see [Table 8](#)**Pins IF1IN and IF1DEC[5]**

$V_{i(sens)}$	sensitivity voltage	FM mode	-	5	10	μV
---------------	---------------------	---------	---	---	----	---------------

Pins AMIF2IN and AMIF2DEC[8]

$V_{i(sens)}$	sensitivity voltage	AM mode; $m = 0$	-	70	260	μV
---------------	---------------------	------------------	---	----	-----	---------------

[1] Measured between pins XTAL1 and XTAL2.

[2] Conversion gain formula of DAA: $V_{DAAOUT} = \left(1.915 \times \frac{n}{128} + 0.1\right) \times V_{VTUNE}$ where $n = 0$ to 127.

[3] Input parameters of AM mixer 1 measured between pins AMMIX1IN and AMMIX1DEC.

[4] Output parameters of FM and AM mixer 1 measured between pins MIX1OUT1 and MIX1OUT2.

[5] Input parameters of FM mixer 2 measured between pins IF1IN and IF1DEC.

[6] Output parameters of AM mixer 2 measured between pins AMMIX2OUT1 and AMMIX2OUT2.

[7] Input parameters of FM mixer 1 measured between pins FMMIX1IN1 and FMMIX1IN2.

[8] Input parameters of AM mixer 2 measured between pins AMIF2IN and AMIF2DEC.

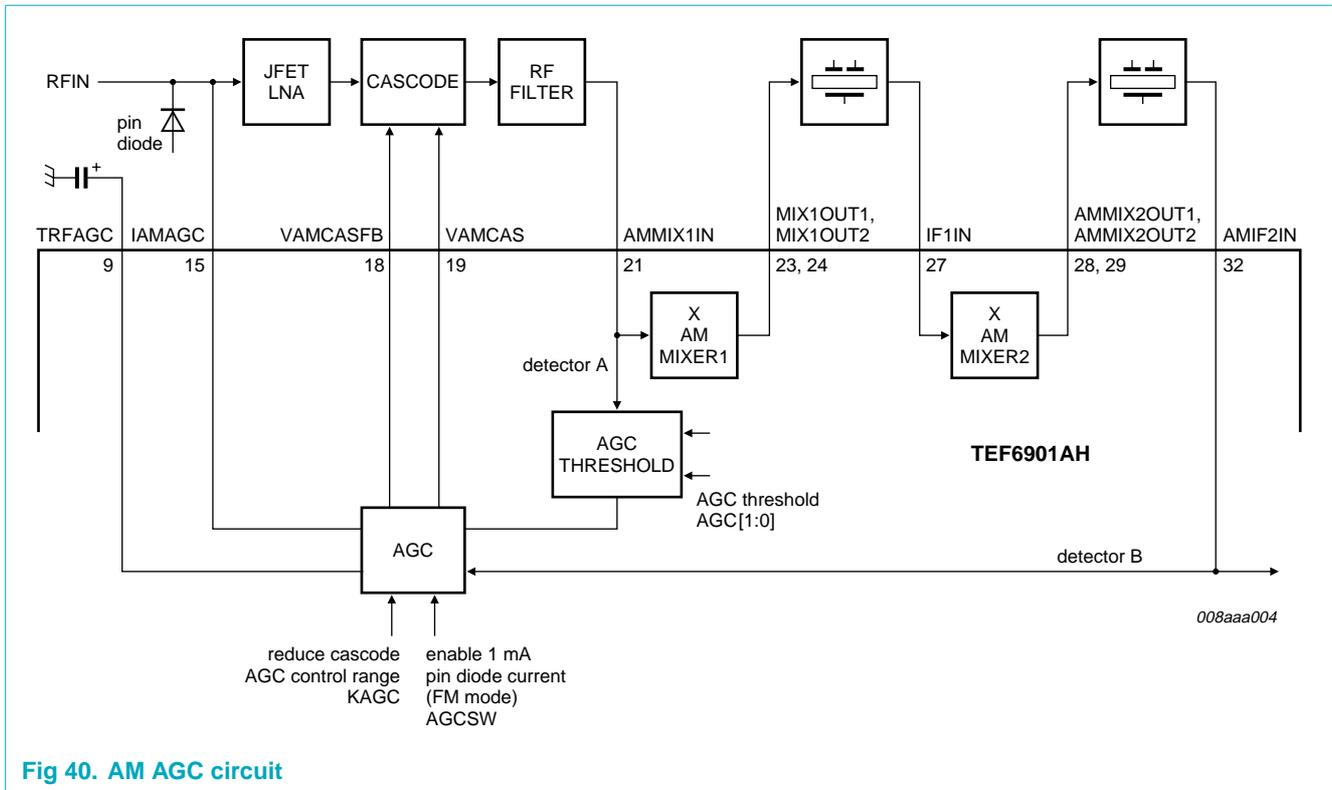

Fig 40. AM AGC circuit

12.2 Dynamic characteristics of the sound processor

Table 111. Dynamic characteristics of the sound processor

$V_{CC} = 8.5\text{ V}$; $T_{amb} = 25\text{ }^{\circ}\text{C}$; see Figure 43; all AC values are given in RMS; treble: 10 kHz filter frequency; treble = 0 dB; bass: 60 Hz filter frequency; bass = 0 dB; $f_{audio} = 1\text{ kHz}$; $G_{vol} = 0\text{ dB}$; $G_{fader} = 0\text{ dB}$; loudness off; standard output gain (byte OUTPUT; bit OUTA = 0); $R_L = 10\text{ k}\Omega$; $C_L = 1\text{ nF}$; unless otherwise specified.

Symbol	Parameter	Conditions	Min	Typ	Max	Unit
Stereo decoder and AM path						
$V_{O(FM)}$	FM mono output voltage on pins LFOUT and RFOUT	$f_{MPXAMOUT} = 1\text{ kHz}$; 30 % FM modulation without pilot	-	330	-	mV
$V_{O(AM)}$	AM output voltage on pins LFOUT and RFOUT	$f_{AM} = 1\text{ kHz}$; 30 % AM modulation	-	365	-	mV
α_{cs}	channel separation	$f_{FMMPX} = 1\text{ kHz}$	40	-	-	dB
$g_{f(L-R)}$	stereo adjust for fine adjustment of separation	measure 1 kHz level for L – R modulation; compare to 1 kHz level for L + R modulation				
		CSA[3:0] = 0000	-	0	-	dB
		CSA[3:0] = 0001	-	0.2	-	dB
		:	-	:	-	dB
		CSA[3:0] = 1110	-	2.8	-	dB
		CSA[3:0] = 1111	-	3.0	-	dB

Table 111. Dynamic characteristics of the sound processor ...continued

$V_{CC} = 8.5\text{ V}$; $T_{amb} = 25\text{ }^{\circ}\text{C}$; see [Figure 43](#); all AC values are given in RMS; treble: 10 kHz filter frequency; treble = 0 dB; bass: 60 Hz filter frequency; bass = 0 dB; $f_{audio} = 1\text{ kHz}$; $G_{vol} = 0\text{ dB}$; $G_{fader} = 0\text{ dB}$; loudness off; standard output gain (byte OUTPUT; bit OUTA = 0); $R_L = 10\text{ k}\Omega$; $C_L = 1\text{ nF}$; unless otherwise specified.

Symbol	Parameter	Conditions	Min	Typ	Max	Unit
S/N	signal-to-noise ratio	$f_{MPXAMIN} = 20\text{ Hz to }15\text{ kHz}$; referenced to 1 kHz at 91 % FM modulation; DEMP = 1	70	-	-	dB
THD	total harmonic distortion	FM mode; DEMP = 1; measured with 15 kHz brick-wall low-pass filter				
		$f_{MPXAMIN} = 200\text{ Hz to }15\text{ kHz}$	-	-	0.3	%
		$V_{MPXAMIN} = 50\%$; L; pilot on	-	-	0.3	%
		$V_{MPXAMIN} = 50\%$; R; pilot on	-	-	0.3	%
$V_{o(bal)}$	mono channel balance $\frac{V_{oL}}{V_{oR}}$	FM mode	-1	-	+1	dB
α_{19}	pilot signal suppression	9 % pilot; $f_{pilot} = 19\text{ kHz}$; referenced to 1 kHz at 91 % FM modulation; DEMP = 1	40	50	-	dB
α	subcarrier suppression	modulation off; referenced to 1 kHz at 91 % FM modulation				
		$f_{sc} = 38\text{ kHz}$	35	50	-	dB
		$f_{sc} = 57\text{ kHz}$	40	-	-	dB
		$f_{sc} = 76\text{ kHz}$	50	60	-	dB
PSRR	power supply ripple rejection	FM mode; $f_{ripple} = 100\text{ Hz}$; $V_{CC(AC)} = V_{ripple} = 100\text{ mV}$ (RMS)	24	-	-	dB
ΔV_{out}	frequency response	FM mode				
		$f_{MPXAMIN} = 20\text{ Hz}$	-0.5	-	+0.5	dB
		$f_{MPXAMIN} = 20\text{ kHz}$	-0.5	-	+0.5	dB
$f_{cut(de-em)}$	cut-off frequency of de-emphasis filter	-3 dB point; see Figure 31				
		DEMP = 1 ($\tau = 50\text{ }\mu\text{s}$)	-	3.18	-	kHz
		DEMP = 0 ($\tau = 75\text{ }\mu\text{s}$)	-	2.12	-	kHz
$m_{i(pilot)}$	pilot threshold modulation for automatic switching by pilot input voltage	stereo				
		on	-	4.0	5.5	%
		off	1.3	2.7	-	%
hys_{pilot}	hysteresis of pilot threshold voltage		-	2	-	dB

Noise blanker**FM part**

$t_{sup(min)}$	minimum suppression time		-	15	-	μs
----------------	-----------------------------	--	---	----	---	---------------

Table 111. Dynamic characteristics of the sound processor ...continued

$V_{CC} = 8.5\text{ V}$; $T_{amb} = 25\text{ °C}$; see [Figure 43](#); all AC values are given in RMS; treble: 10 kHz filter frequency; treble = 0 dB; bass: 60 Hz filter frequency; bass = 0 dB; $f_{audio} = 1\text{ kHz}$; $G_{vol} = 0\text{ dB}$; $G_{fader} = 0\text{ dB}$; loudness off; standard output gain (byte OUTPUT; bit OUTA = 0); $R_L = 10\text{ k}\Omega$; $C_L = 1\text{ nF}$; unless otherwise specified.

Symbol	Parameter	Conditions	Min	Typ	Max	Unit	
$V_{MPXAMIN(M)}$	noise blanker sensitivity at MPXAMIN input (peak value of noise pulses)	$t_{pulse} = 10\text{ }\mu\text{s}$; $f_{pulse} = 100\text{ Hz}$					
		NBS[1:0] = 00	-	65	-	mV	
		NBS[1:0] = 01	-	100	-	mV	
		NBS[1:0] = 10	-	125	-	mV	
$V_{LEVEL(M)}$	noise blanker sensitivity at LEVEL output (peak value of noise pulses) (test mode)	$t_{pulse} = 10\text{ }\mu\text{s}$; $f_{pulse} = 100\text{ Hz}$					
		NBL[1:0] = 00	-	10	-	mV	
		NBL[1:0] = 01	-	25	-	mV	
		NBL[1:0] = 10	-	36	-	mV	
		NBL[1:0] = 11	-	50	-	mV	
		AM audio part					
		$t_{sup(min)}$	minimum suppression time	-	200	-	μs
		M_{AM}	noise blanker sensitivity; triggered from pulses at MPXAMIN slew rate	NBS[1:0] = 00	-	16.5	-
NBS[1:0] = 01	-			18.6	-	V/ms	
NBS[1:0] = 10	-			21	-	V/ms	
NBS[1:0] = 11	-			23.5	-	V/ms	
Weak signal processing							
Detectors							
$V_{eq(USN)}$	USN sensitivity equivalent level voltage $\frac{V_{eq(USN)}}{\Delta f}$	see Figure 24 ; $f_{MPXAMOUT} = 150\text{ kHz}$; $V_{MPXAMOUT} = 250\text{ mV}$; HCMP = 1				[1]	
		USS[1:0] = 00	-	-0.06	-	V/kHz	
		USS[1:0] = 01	-	-0.08	-	V/kHz	
		USS[1:0] = 10	-	-0.12	-	V/kHz	
$V_{eq(WAM)}$	WAM sensitivity equivalent level voltage $\frac{V_{eq(WAM)}}{V_{LEVEL(p-p)}}$	see Figure 24 ; $V_{LEVEL} = 200\text{ mV (p-p)}$ at $f = 21\text{ kHz}$ on the level voltage; HCMP = 1				[1]	
		WAS[1:0] = 00	-	-7.5	-	-	
		WAS[1:0] = 01	-	-10	-	-	
		WAS[1:0] = 10	-	-15	-	-	
		WAS[1:0] = 11	-	-20	-	-	

Table 111. Dynamic characteristics of the sound processor ...continued

$V_{CC} = 8.5\text{ V}$; $T_{amb} = 25\text{ °C}$; see [Figure 43](#); all AC values are given in RMS; treble: 10 kHz filter frequency; treble = 0 dB; bass: 60 Hz filter frequency; bass = 0 dB; $f_{audio} = 1\text{ kHz}$; $G_{vol} = 0\text{ dB}$; $G_{fader} = 0\text{ dB}$; loudness off; standard output gain (byte OUTPUT; bit OUTA = 0); $R_L = 10\text{ k}\Omega$; $C_L = 1\text{ nF}$; unless otherwise specified.

Symbol	Parameter	Conditions	Min	Typ	Max	Unit
Setting of time constants for SNC, MUTE and HCC						
$t_{USN(attack)}$	USN detector attack time	soft mute and SNC	-	1	-	ms
$t_{USN(recovery)}$	USN detector recovery time	soft mute and SNC	-	1	-	ms
ΔUSS	USN detector desensitization	USN sensitivity setting (USS) versus level voltage (USN sensitivity setting is automatically reduced as level voltage decreases)				
		$V_{LEVEL} > 1.25\text{ V}$	-	-	3	-
		$1.25\text{ V} > V_{LEVEL} > 1.125\text{ V}$	-	-	2	-
		$1.125\text{ V} > V_{LEVEL} > 1.0\text{ V}$	-	-	1	-
		$1.0\text{ V} > V_{LEVEL}$	-	-	0	-
$t_{WAM(attack)}$	WAM detector attack time (SNC)		-	1	-	ms
$t_{WAM(recovery)}$	WAM detector recovery time (SNC)		-	1	-	ms
$t_{peak(USN)(attack)}$	peak detector attack time for USN read-out via I ² C-bus		-	1	-	ms
$t_{peak(USN)(recovery)}$	peak detector recovery time for USN read-out via I ² C-bus		-	10	-	ms
$t_{peak(WAM)(attack)}$	peak detector attack time for WAM read-out via I ² C-bus		-	1	-	ms
$t_{peak(WAM)(recovery)}$	peak detector recovery time for WAM read-out via I ² C-bus		-	10	-	ms

Table 111. Dynamic characteristics of the sound processor ...continued

$V_{CC} = 8.5\text{ V}$; $T_{amb} = 25\text{ °C}$; see [Figure 43](#); all AC values are given in RMS; treble: 10 kHz filter frequency; treble = 0 dB; bass: 60 Hz filter frequency; bass = 0 dB; $f_{audio} = 1\text{ kHz}$; $G_{vol} = 0\text{ dB}$; $G_{fader} = 0\text{ dB}$; loudness off; standard output gain (byte OUTPUT; bit OUTA = 0); $R_L = 10\text{ k}\Omega$; $C_L = 1\text{ nF}$; unless otherwise specified.

Symbol	Parameter	Conditions	Min	Typ	Max	Unit
Control functions						
$V_{start(mute)}$	soft mute start voltage	FM mode; see Figure 28 ; equivalent level voltage that causes $\alpha_{mute} = 3\text{ dB}$; MSL[1:0] = 11				
		MST[2:0] = 000	-	0.75	-	V
		MST[2:0] = 001	-	0.88	-	V
		MST[2:0] = 010	-	1	-	V
		MST[2:0] = 011	-	1.12	-	V
		MST[2:0] = 100	-	1.25	-	V
		MST[2:0] = 101	-	0.68	-	V
		MST[2:0] = 110	-	0.73	-	V
		MST[2:0] = 111	-	0.85	-	V
		AM mode; see Figure 29 ; equivalent level voltage that causes $\alpha_{mute} = 3\text{ dB}$; MSL[1:0] = 11				
		MST[2:0] = 000	-	1.35	-	V
		MST[2:0] = 001	-	1.58	-	V
		MST[2:0] = 010	-	1.80	-	V
		MST[2:0] = 011	-	1.12	-	V
		MST[2:0] = 100	-	1.25	-	V
		MST[2:0] = 101	-	1.50	-	V
		MST[2:0] = 110	-	1.70	-	V
		MST[2:0] = 111	-	1.91	-	V

Table 111. Dynamic characteristics of the sound processor ...continued

$V_{CC} = 8.5\text{ V}$; $T_{amb} = 25\text{ °C}$; see [Figure 43](#); all AC values are given in RMS; treble: 10 kHz filter frequency; treble = 0 dB; bass: 60 Hz filter frequency; bass = 0 dB; $f_{audio} = 1\text{ kHz}$; $G_{vol} = 0\text{ dB}$; $G_{fader} = 0\text{ dB}$; loudness off; standard output gain (byte OUTPUT; bit OUTA = 0); $R_L = 10\text{ k}\Omega$; $C_L = 1\text{ nF}$; unless otherwise specified.

Symbol	Parameter	Conditions	Min	Typ	Max	Unit
C_{mute}	soft mute slope $C_{mute} = \frac{\Delta\alpha_{mute}}{\Delta V_{eq.LEVEL}}$	FM mode; see Figure 28 ; slope of soft mute attenuation with respect to equivalent level voltage; MST[2:0] = 000				
		MSLE = 0; MSL[1:0] = 00	-	8	-	dB/V
	MSLE = 0; MSL[1:0] = 01	-	16	-	dB/V	
	MSLE = 0; MSL[1:0] = 10	-	24	-	dB/V	
	MSLE = 0; MSL[1:0] = 11	-	32	-	dB/V	
	MSLE = 1; MSL[1:0] = 00	-	40	-	dB/V	
	MSLE = 1; MSL[1:0] = 01	-	48	-	dB/V	
	AM mode; see Figure 29 ; slope of soft mute attenuation with respect to equivalent level voltage; MST[2:0] = 011					
	MSLE = 0; MSL[1:0] = 00	-	8	-	dB/V	
	MSLE = 0; MSL[1:0] = 01	-	12	-	dB/V	
	MSLE = 0; MSL[1:0] = 10	-	16	-	dB/V	
	MSLE = 0; MSL[1:0] = 11	-	20	-	dB/V	
	MSLE = 1; MSL[1:0] = 00	-	24	-	dB/V	
	MSLE = 1; MSL[1:0] = 01	-	28	-	dB/V	
	MSLE = 1; MSL[1:0] = 10	-	32	-	dB/V	
	MSLE = 1; MSL[1:0] = 11	-	36	-	dB/V	
$\alpha_{mute(max)}$	maximum soft mute attenuation by USN	see Figure 30 ; $f_{MPXAMOUT} = 150\text{ kHz}$; $V_{MPXAMOUT} = 0.6\text{ V (RMS)}$; USS[1:0] = 11				
		UMD[1:0] = 00	-	3	-	dB
		UMD[1:0] = 01	-	6	-	dB
		UMD[1:0] = 10	-	9	-	dB
		UMD[1:0] = 11	-	12	-	dB
$V_{start(SNC)}$	SNC stereo blend start voltage	see Figure 25 ; equivalent level voltage that causes channel separation is 10 dB; SSL[1:0] = 10				
		SST[3:0] = 0000	-	1.5	-	V
		:	-	:	-	V
		SST[3:0] = 1000	-	2.0	-	V
		:	-	:	-	V
		SST[3:0] = 1111	-	2.45	-	V

Table 111. Dynamic characteristics of the sound processor ...continued

$V_{CC} = 8.5\text{ V}$; $T_{amb} = 25\text{ °C}$; see [Figure 43](#); all AC values are given in RMS; treble: 10 kHz filter frequency; treble = 0 dB; bass: 60 Hz filter frequency; bass = 0 dB; $f_{audio} = 1\text{ kHz}$; $G_{vol} = 0\text{ dB}$; $G_{fader} = 0\text{ dB}$; loudness off; standard output gain (byte OUTPUT; bit OUTA = 0); $R_L = 10\text{ k}\Omega$; $C_L = 1\text{ nF}$; unless otherwise specified.

Symbol	Parameter	Conditions	Min	Typ	Max	Unit
C_{SNC}	SNC slope $C_{SNC} = \frac{\Delta\alpha_{cs}}{\Delta V_{eq.LEVEL}}$	see Figure 25 ; slope of channel separation between 30 dB and 10 dB with respect to level voltage; SST[3:0] = 1010				
		SSL[1:0] = 00	-	38	-	dB/V
		SSL[1:0] = 01	-	51	-	dB/V
		SSL[1:0] = 10	-	63	-	dB/V
		SSL[1:0] = 11	-	72	-	dB/V
$V_{start(HCC)}$	HCC start voltage	see Figure 26 ; $f_{audio} = 10\text{ kHz}$; equivalent level voltage that causes $\alpha_{HCC} = 3\text{ dB}$; HSL[1:0] = 10				
		HST[2:0] = 000	-	1.17	-	V
		HST[2:0] = 001	-	1.42	-	V
		HST[2:0] = 010	-	1.67	-	V
		HST[2:0] = 011	-	1.92	-	V
		HST[2:0] = 100	-	2.17	-	V
		HST[2:0] = 101	-	2.67	-	V
		HST[2:0] = 110	-	3.17	-	V
		HST[2:0] = 111	-	3.67	-	V
C_{HCC}	HCC slope $C_{HCC} = \frac{\Delta\alpha_{10\text{ kHz}}}{\Delta V_{eq.LEVEL}}$	see Figure 26 ; $f_{audio} = 10\text{ kHz}$; HST[2:0] = 010				
		HSL[1:0] = 00	-	9	-	dB/V
		HSL[1:0] = 01	-	11	-	dB/V
		HSL[1:0] = 10	-	14	-	dB/V
		HSL[1:0] = 11	-	18	-	dB/V
$\alpha_{HCC(max)}$	maximum HCC attenuation	see Figure 26 ; $f_{audio} = 10\text{ kHz}$				
		HCSF = 1; HCSFH = 0	-	10	-	dB
		HCSF = 0; HCSFH = 0	-	14	-	dB
f_{cut}	cut-off frequency of fixed HCC	see Figure 27 ; -3 dB point (first order filter)				
		HCF[2:0] = 000	-	reserved	-	kHz
		HCF[2:0] = 001	-	2	-	kHz
		HCF[2:0] = 010	-	3	-	kHz
		HCF[2:0] = 011	-	5	-	kHz
		HCF[2:0] = 100	-	7	-	kHz
		HCF[2:0] = 101	-	10	-	kHz
		HCF[2:0] = 110	-	wide	-	-
		HCF[2:0] = 111	-	unlimited	-	-

Table 111. Dynamic characteristics of the sound processor ...continued

$V_{CC} = 8.5\text{ V}$; $T_{amb} = 25\text{ °C}$; see [Figure 43](#); all AC values are given in RMS; treble: 10 kHz filter frequency; treble = 0 dB; bass: 60 Hz filter frequency; bass = 0 dB; $f_{audio} = 1\text{ kHz}$; $G_{vol} = 0\text{ dB}$; $G_{fader} = 0\text{ dB}$; loudness off; standard output gain (byte OUTPUT; bit OUTA = 0); $R_L = 10\text{ k}\Omega$; $C_L = 1\text{ nF}$; unless otherwise specified.

Symbol	Parameter	Conditions	Min	Typ	Max	Unit
Analog-to-digital converters for I²C-bus						
Level analog-to-digital converter (8-bit); see Table 10						
$V_{LEVEL(min)}$	lower voltage limit of conversion range		-	0.25	-	V
$V_{LEVEL(max)}$	upper voltage limit of conversion range		-	4.25	-	V
ΔV_{LEVEL}	bit resolution voltage		-	15.7	-	mV
Ultrasonic noise analog-to-digital converter (4-bit); see Figure 24						
$\Delta f_{USN(min)}$	conversion range lower deviation limit	$f_{MPXAMOUT} = 150\text{ kHz}$	-	0	-	kHz
$\Delta f_{USN(max)}$	conversion range upper deviation limit	$f_{MPXAMOUT} = 150\text{ kHz}$	-	100	-	kHz
Δf_{USN}	bit resolution		-	6.25	-	kHz
Wideband AM analog-to-digital converter (4-bit); see Figure 24						
$V_{WAM(min)(p-p)}$	lower voltage limit of conversion range (peak-to-peak value)	$f_{LEVEL} = 21\text{ kHz}$	-	0	-	mV
$V_{WAM(max)(p-p)}$	upper voltage limit of conversion range (peak-to-peak value)	$f_{LEVEL} = 21\text{ kHz}$	-	800	-	mV
$\Delta V_{WAM(p-p)}$	bit resolution voltage (peak-to-peak value)		-	53.3	-	mV
Tone/volume control						
Z_i	input impedance	measured unbalanced; pins INAL, INAR, INAC, INBL, INBR, INC and IND	110	160	-	k Ω
Z_o	output impedance	pins LFOUT, RFOUT, LROUT and RROUT	-	-	100	Ω
$G_{s(main)}$	signal gain from pins INAL, INAR, INAC, INBL, INBR, INC and IND to LFOUT, RFOUT, LROUT and RROUT		-1	-	+1	dB
$V_{i(max)}$	maximum input voltage	THD = 0.2 %; $G_{vol} = -6\text{ dB}$; pins INAL, INAR, INAC, INBL, INBR, INC and IND	2	-	-	V

Table 111. Dynamic characteristics of the sound processor ...continued

$V_{CC} = 8.5\text{ V}$; $T_{amb} = 25\text{ °C}$; see [Figure 43](#); all AC values are given in RMS; treble: 10 kHz filter frequency; treble = 0 dB; bass: 60 Hz filter frequency; bass = 0 dB; $f_{audio} = 1\text{ kHz}$; $G_{vol} = 0\text{ dB}$; $G_{fader} = 0\text{ dB}$; loudness off; standard output gain (byte OUTPUT; bit OUTA = 0); $R_L = 10\text{ k}\Omega$; $C_L = 1\text{ nF}$; unless otherwise specified.

Symbol	Parameter	Conditions	Min	Typ	Max	Unit
$V_{o(max)}$	maximum output voltage	$G_{vol} = +6\text{ dB}$				
		THD = 0.2 %	1.4	1.8	-	V
		THD = 1 %; $R_L = 5\text{ k}\Omega$; $C_L = 10\text{ nF}$	1.4	1.8	-	V
		$G_{vol} = +3\text{ dB}$; OUTA = 1 (+3 dB)				
		THD = 0.2 %	2	2.2	-	V
		THD = 0.2 %; $V_{CC} = 8.0\text{ V}$	1.6	1.8	-	V
		$R_L = 5\text{ k}\Omega$; $C_L = 10\text{ nF}$; THD = 1 %	2	2.25	-	V
		$R_L = 5\text{ k}\Omega$; $C_L = 10\text{ nF}$; THD = 1 %; $V_{CC} = 8.0\text{ V}$	1.7	1.9	-	V
f_{max}	frequency response (pins INAL, INAR, INAC, INBL, INBR, INC and IND)	upper -1 dB point; referenced to 1 kHz	20	-	-	kHz
α_{ASI}	attenuation during ASI	$f = 20\text{ kHz}$ referenced to 1 kHz	-	0.15	1	dB
CMRR	common mode rejection ratio	$G_{vol} = 0\text{ dB}$; line input capacitance $C_i = 1\text{ }\mu\text{F}$				
		$f_{audio} = 1\text{ kHz}$ on common mode inputs	-	60	-	dB
		$f_{audio} = 20\text{ Hz}$ to 20 kHz on common mode inputs	40	-	-	dB
THD	total harmonic distortion	configured as non-inverting, single ended inputs				
		$f_{audio} = 20\text{ Hz}$ to 10 kHz; $V_i = 1\text{ V (RMS)}$	-	0.02	0.1	%
		$f_{audio} = 20\text{ Hz}$ to 10 kHz; $V_i = 2\text{ V (RMS)}$; $G_{vol} = -10\text{ dB}$	-	0.03	0.2	%
		$f_{audio} = 25\text{ Hz}$; $V_i = 500\text{ mV (RMS)}$; $G_{bass} = +8\text{ dB}$; $G_{vol} = 0\text{ dB}$	-	0.025	0.2	%
		$f_{audio} = 4\text{ kHz}$; $V_i = 500\text{ mV (RMS)}$; $G_{treble} = +8\text{ dB}$; $G_{vol} = 0\text{ dB}$	-	0.02	0.2	%
α_{cs}	channel separation	$f_{audio} = 20\text{ Hz}$ to 20 kHz	60	75	-	dB
α_S	input isolation of one selected source to any other input	source impedance of unused input: 600 Ω				
		$f_{audio} = 20\text{ Hz}$ to 10 kHz	75	90	-	dB
		$f_{audio} = 20\text{ kHz}$	70	-	-	dB

Table 111. Dynamic characteristics of the sound processor ...continued

$V_{CC} = 8.5\text{ V}$; $T_{amb} = 25\text{ °C}$; see [Figure 43](#); all AC values are given in RMS; treble: 10 kHz filter frequency; treble = 0 dB; bass: 60 Hz filter frequency; bass = 0 dB; $f_{audio} = 1\text{ kHz}$; $G_{vol} = 0\text{ dB}$; $G_{fader} = 0\text{ dB}$; loudness off; standard output gain (byte OUTPUT; bit OUTA = 0); $R_L = 10\text{ k}\Omega$; $C_L = 1\text{ nF}$; unless otherwise specified.

Symbol	Parameter	Conditions	Min	Typ	Max	Unit	
$V_{noise(rms)}$	noise voltage (RMS value)	CCIR-ARM weighted and 20 kHz 'brick wall' without input signal (source impedance 600 Ω); unbalanced					
		$G_{vol} = 0\text{ dB}$	-	12	20	μV	
		$G_{bass} = +6\text{ dB}$; $G_{treble} = +6\text{ dB}$; $G_{vol} = 0\text{ dB}$	-	24	35	μV	
		$G_{vol} = +20\text{ dB}$	-	71	100	μV	
		$G_{vol} = +20\text{ dB}$; balanced	-	100	140	μV	
		$G_{vol} = -10\text{ dB}$	-	10	18	μV	
		$G_{vol} = -40\text{ dB}$	-	9.5	13.5	μV	
		outputs muted using 'A-weighting' filter and 20 kHz 'brick wall'; $G_{vol} = -20\text{ dB}$; start of loudness = -12 dB	-	6.8	10	μV	
$V_{offset(max)}$	maximum DC offset	between any two settings (non-consecutive) on any one audio control	-	7	-	mV	
		between any two settings (non-consecutive) on volume control; $G_{vol} \leq +6\text{ dB}$	-	7	-	mV	
		between any two settings (non-consecutive) on input gain control; $G_{ing} \leq +6\text{ dB}$	-	7	-	mV	
PSRR	power supply ripple rejection	$V_{CC(AC)} = V_{ripple} = 200\text{ mV}$ (RMS); $G_{vol} = 0\text{ dB}$					
		$f_{ripple} = 20\text{ Hz to }100\text{ Hz}$	35	65	-	dB	
		$f_{ripple} = 100\text{ Hz to }1\text{ kHz}$	50	70	-	dB	
		$f_{ripple} = 1\text{ kHz to }20\text{ kHz}$	30	50	-	dB	
		$f_{ripple} = 500\text{ Hz}$	-	70	-	dB	
α_{ct}	crosstalk between bus inputs and signal outputs	$f_{clk} = 100\text{ kHz}$	[2]	-	110	-	dB
t_d	delay time from V_{CC} applied to final DC voltage at outputs		-	12	-	ms	
Input gain							
G_{ing}	input gain control	see Table 76					
		maximum setting	[3]	-	18	-	dB
		minimum setting	[3]	-	-10	-	dB
$G_{step(vol)}$	step resolution		-	2	-	dB	

Table 111. Dynamic characteristics of the sound processor ...continued

$V_{CC} = 8.5\text{ V}$; $T_{amb} = 25\text{ °C}$; see [Figure 43](#); all AC values are given in RMS; treble: 10 kHz filter frequency; treble = 0 dB; bass: 60 Hz filter frequency; bass = 0 dB; $f_{audio} = 1\text{ kHz}$; $G_{vol} = 0\text{ dB}$; $G_{fader} = 0\text{ dB}$; loudness off; standard output gain (byte OUTPUT; bit OUTA = 0); $R_L = 10\text{ k}\Omega$; $C_L = 1\text{ nF}$; unless otherwise specified.

Symbol	Parameter	Conditions	Min	Typ	Max	Unit	
Volume							
G_{vol}	volume/balance gain control	see Table 83					
		maximum setting	[3]	-	20	-	dB
		minimum setting	[3]	-	-75	-	dB
		mute attenuation; 20 Hz to 20 kHz		-	-90	-80	dB
$G_{step(vol)}$	step resolution		-	1	-	dB	
$ \Delta G_{set} $	gain set error	$G_{vol} = +20\text{ dB to }-35\text{ dB}$	-	0.25	1	dB	
		$G_{vol} = -36\text{ dB to }-75\text{ dB}$	-	0.55	3	dB	
$\Delta G_{step(vol)}$	gain step error		-	-	1	dB	
$ \Delta G_{track} $	gain tracking error between left and right	$G_{vol} = +20\text{ dB to }-35\text{ dB}$	-	0.1	1	dB	
		$G_{vol} = -36\text{ dB to }-75\text{ dB}$	-	0.3	3	dB	
Loudness; see Table 100 and Figure 39							
G_{bass}	loudness bass control range		[4]	-	20	-	dB
G_{treble}	loudness treble control range		-	4	-	dB	
G_{step}	loudness step resolution		-	2	-	dB	
Treble							
f_{treble}	treble control filter frequency	see Figure 37 ; -3 dB frequency of maximum treble setting referenced to 100 kHz					
		TRF[1:0] = 00	-	8	-	kHz	
		TRF[1:0] = 01	-	10	-	kHz	
		TRF[1:0] = 10	-	12	-	kHz	
		TRF[1:0] = 11	-	15	-	kHz	
G_{treble}	treble gain control	TRE[2:0] = 111; TREM = 1	-	14	-	dB	
		TRE[2:0] = 111; TREM = 0	-	-14	-	dB	
$G_{step(treble)}$	step resolution gain		-	2	-	dB	
$\Delta G_{step(treble)}$	treble step error		-	-	0.5	dB	
Bass							
f_{bass}	bass control filter frequency at maximum gain	see Figure 26					
		BAF[1:0] = 00	-	60	-	Hz	
		BAF[1:0] = 01	-	80	-	Hz	
		BAF[1:0] = 10	-	100	-	Hz	
		BAF[1:0] = 11	-	120	-	Hz	
G_{bass}	bass gain control	BAS[3:0] = 0111; BAM = 1	-	14	-	dB	
		BAS[3:0] = 0111; BAM = 0	-	-14	-	dB	
$G_{step(bass)}$	step resolution gain		-	2	-	dB	
$\Delta G_{step(bass)}$	bass step error		-	-	0.5	dB	

Table 111. Dynamic characteristics of the sound processor ...continued

$V_{CC} = 8.5$ V; $T_{amb} = 25$ °C; see [Figure 43](#); all AC values are given in RMS; treble: 10 kHz filter frequency; treble = 0 dB; bass: 60 Hz filter frequency; bass = 0 dB; $f_{audio} = 1$ kHz; $G_{vol} = 0$ dB; $G_{fader} = 0$ dB; loudness off; standard output gain (byte OUTPUT; bit OUTA = 0); $R_L = 10$ k Ω ; $C_L = 1$ nF; unless otherwise specified.

Symbol	Parameter	Conditions	Min	Typ	Max	Unit
EQ _{bow}	equalizer bowing	$f_{audio} = 1$ kHz; $V_i = 500$ mV (RMS); $G_{bass} = +12$ dB; $f_{bass} = 60$ Hz; $G_{treble} = +12$ dB; $f_{cut(treble)} = 15$ kHz	-	1.8	-	dB
Fader						
G _{fader}	fader gain control	see Table 91				
		maximum setting	-	0	-	dB
		minimum setting	-	-64	-	dB
		output mute	-	-	-80	dB
G _{step(fader)}	step resolution gain		-	1	-	dB
$\Delta G_{step(fader)}$	fader step error		-	-	1	dB
α_{mute}	audio mute	volume control: mute and output muted (bits MULF, MURF, MULR and MURR)	80	90	-	dB

- [1] The equivalent level voltage is that value of the level voltage (on pin LEVEL) which results in the same weak signal control effect (for instance HCC roll-off) as the output value of the specified detector (USN, WAM and MPH).
- [2] Crosstalk between bus inputs and signal outputs: $\alpha_{ct} = 20 \log \frac{V_{bus(p-p)}}{V_{o(rms)}}$
- [3] The input gain setting ING and the volume setting VOL define the overall volume. The overall range is limited to -83 dB to +28 dB. For values > +28 dB the actual value is +28 dB. For overall values < -83 dB the actual value is mute.
- [4] The maximum bass gain including BASS setting is +20 dB.

13. I²C-bus characteristics

The maximum I²C-bus communication speed is 400 kbit/s. SDA and SCL HIGH and LOW internal thresholds are specified according to an I²C-bus voltage range from 2.5 V to 3.3 V including I²C-bus voltage tolerances of 10 %. The bus interface tolerates also SDA and SCL signals from a 5 V bus. Restrictions for V_{IL} in a 5 V application can be derived from [Table 112](#).

Table 112. I²C-bus parameters

Symbol	Parameter	Conditions	Min	Typ	Max	Unit
V _{IL}	LOW-level input voltage		-	-	1.09	V
V _{IH}	HIGH-level input voltage		1.56	-	-	V
C _{SDA}	capacitance of SDA pin		-	4	6	pF
C _{SCL}	capacitance of SCL pin		-	3	5	pF

Table 112. I²C-bus parameters ...continued

Symbol	Parameter	Conditions	Min	Typ	Max	Unit
t _{DOR(HL)}	data output reaction time (acknowledge and read data) HIGH-to-LOW	V _{DD} = 5 V; I = 3 mA; C _b = 400 pF; see Figure 41	-	700	863	ns
		V _{DD} = 3.3 V; R _p = 1.8 kΩ; C _b = 400 pF; see Figure 41	-	570	668	ns
		V _{DD} = 2.5 V; R _p = 35 kΩ; C _b = 10 pF; see Figure 41	-	520	593	ns
t _{DOR(LH)}	data output reaction time (read data) LOW-to-HIGH	see Figure 41	-	450	488	ns
t _{of}	output fall time	C _b = 10 pF to 120 pF; see Figure 42	[1] 20 + 0.1C _b	10 × V _{DD}	-	ns
		C _b ≥ 120 pF; see Figure 42	[1][2] 20 + 0.1C _b	-	250	ns

[1] Minimum value of t_{of}; C_b = total capacitance of one I²C-bus line [pF].

[2] Typical value of t_{of}; the output fall time t_{of} [ns] depends on the total load capacitance C_b [pF] and the I²C-bus voltage V_{DD} [V]:
 $t_{of} = \frac{1}{12} \times V_{DD} \times C_b$.

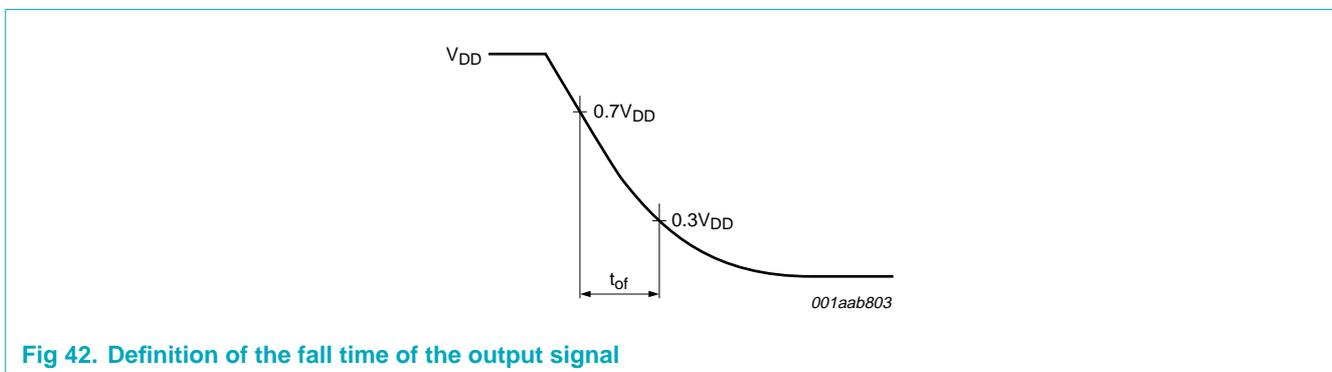
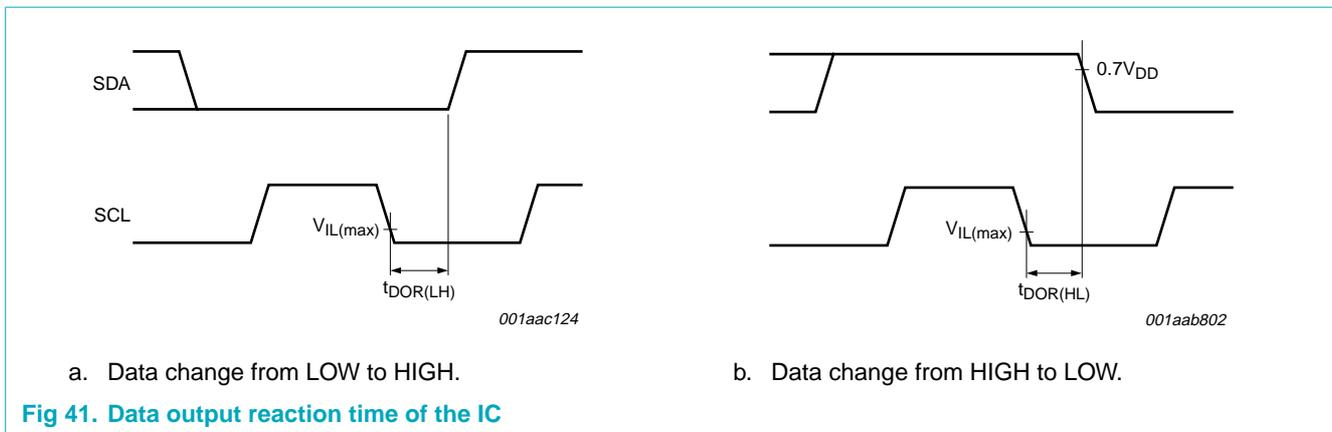

14. Overall system parameters

Table 113. Overall system parameters

Symbol	Parameter	Conditions	Min	Typ	Max	Unit
Supply current in FM mode						
I_{CC}	total supply current inclusive I_{V60}		-	102	-	mA
Supply current in AM mode						
I_{CC}	total supply current inclusive I_{V60}		-	89	-	mA
AM overall system parameters						
f_{tune}	AM tuning frequency	LW	144	-	288	kHz
		MW	522	-	1710	kHz
		SW	2.3	-	26.1	MHz
V_{sens}	sensitivity voltage	$f_{RF} = 990$ kHz; $m = 0.3$; $f_{mod} = 1$ kHz; $B_{AF} = 2.15$ kHz; $(S+N)/N = 26$ dB; dummy aerial 15 pF/60 pF	-	50	-	μ V
S/N	ultimate signal-to-noise ratio		54	58	-	dB
THD	total harmonic distortion	200μ V < V_{RF} < 1 V; $m = 0.8$; $f_{AF} = 400$ Hz	-	0.4	1	%
IP3	3rd-order intercept point	$\Delta f = 40$ kHz	-	130	-	dB μ V
FM overall system parameters						
f_{tune}	FM tuning frequency		65	-	108	MHz
V_{sens}	sensitivity voltage (RF input voltage at $(S+N)/N = 26$ dB)	$\Delta f = 22.5$ kHz; $f_{mod} = 1$ kHz; DEMP = 1; B = 300 Hz to 22 kHz; measured with 75 Ω dummy antenna and test circuit	-	2	-	μ V
(S+N)/N	maximum signal plus noise-to-noise ratio of MPXAM output voltage	$V_i = 3$ mV; $\Delta f = 22.5$ kHz; $f_{mod} = 1$ kHz; DEMP = 1; B = 300 Hz to 22 kHz; measured with 75 Ω dummy antenna and test circuit	-	60	-	dB
THD	total harmonic distortion	$\Delta f = 75$ kHz	-	0.5	1	%
IP3	3rd-order intercept point	$\Delta f = 400$ kHz	-	120	-	dB μ V

15. Application information

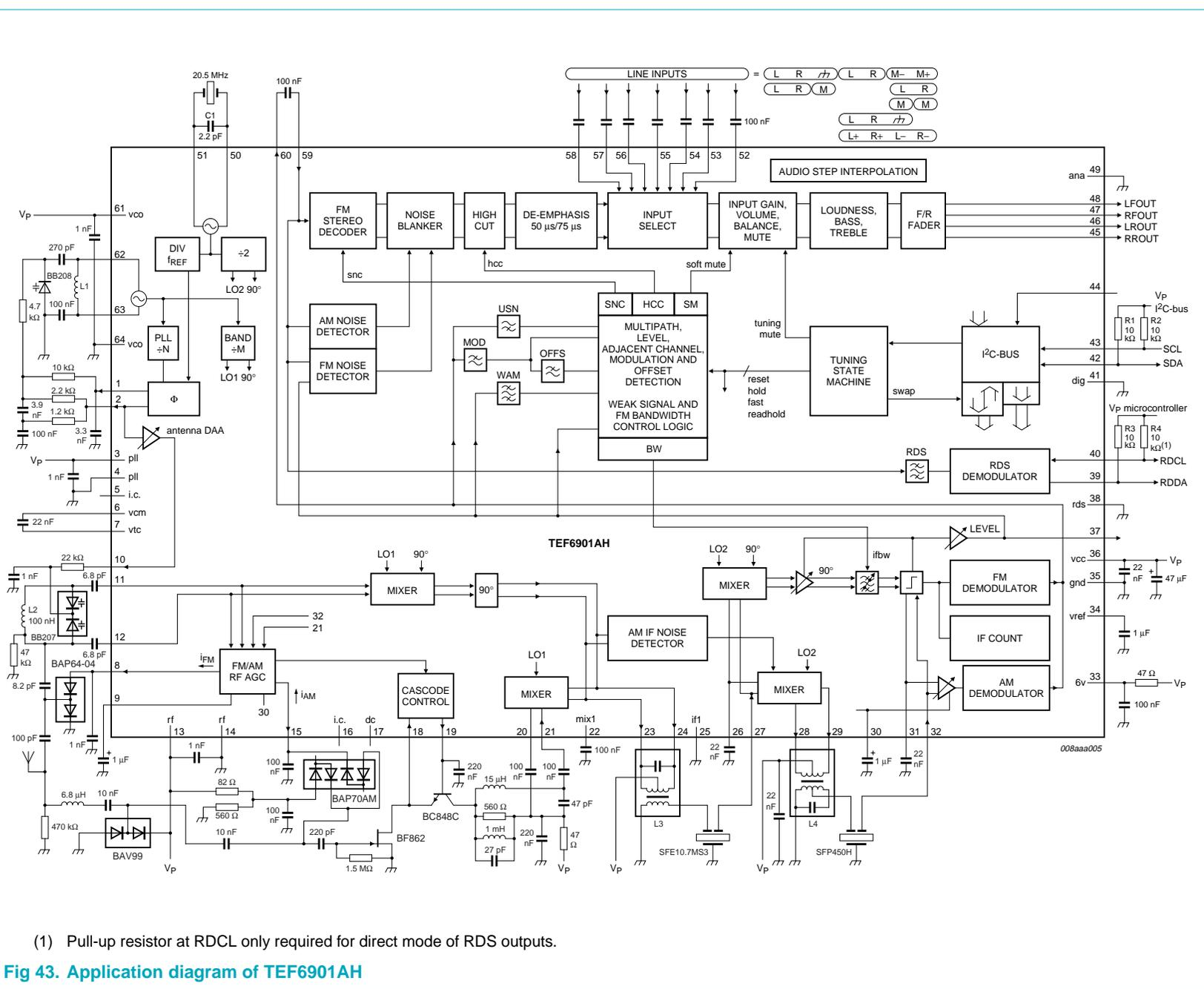

(1) Pull-up resistor at RDCL only required for direct mode of RDS outputs.

Fig 43. Application diagram of TEF6901AH

Table 114. List of components^[1]

Symbol	Component	Type	Manufacturer
C1	capacitor for frequency pulling	2.2 pF ^[2]	-
C2	capacitor for VCO tuning	270 pF	-
C3	decoupling capacitor for VCO tuning	1 nF	-
R1	resistor for supply V60	47 Ω ; 0.2 W	-
L1	oscillator coil	E543SNAS-02010	TOKO
L2	FM RF selectivity coil	C6342A-R11	SAGAMI
L3	10.7 MHz IF transformer	PF670CCS-A065DX	TOKO
L4	450 kHz IF transformer	P7PSGAE-A021YBY=S	TOKO
X1	crystal 20.5 MHz	LN-G102-587	NDK
D1	VCO varactor diode	BB208	Philips
D2	RF selectivity varactor diode	BB207	Philips
D3	FM PIN diode	BAP64-04	Philips
D4	AM PIN diode	BAP70AM	Philips
D5	Electrostatic Discharge (ESD) protection diode	BAV99	Philips
T1	AM Low Noise Amplifier (LNA) JFET transistor	BF862	Philips
T2	AM LNA cascode transistor	BC847C	Philips
F1	10.7 MHz ceramic filter	SFELA10M7HAA0-B0	MURATA
F2	450 kHz ceramic filter	CFWLA450KGFA-B0	MURATA

[1] All low value capacitors (≤ 1 nF) must be of NP0 type for guaranteed high frequency performance.

[2] The capacitor is used to achieve a crystal frequency of 20.5 MHz together with the crystal type LN-G102-587.

16. Package outline

QFP64: plastic quad flat package; 64 leads (lead length 1.6 mm); body 14 x 14 x 2.7 mm

SOT393-1

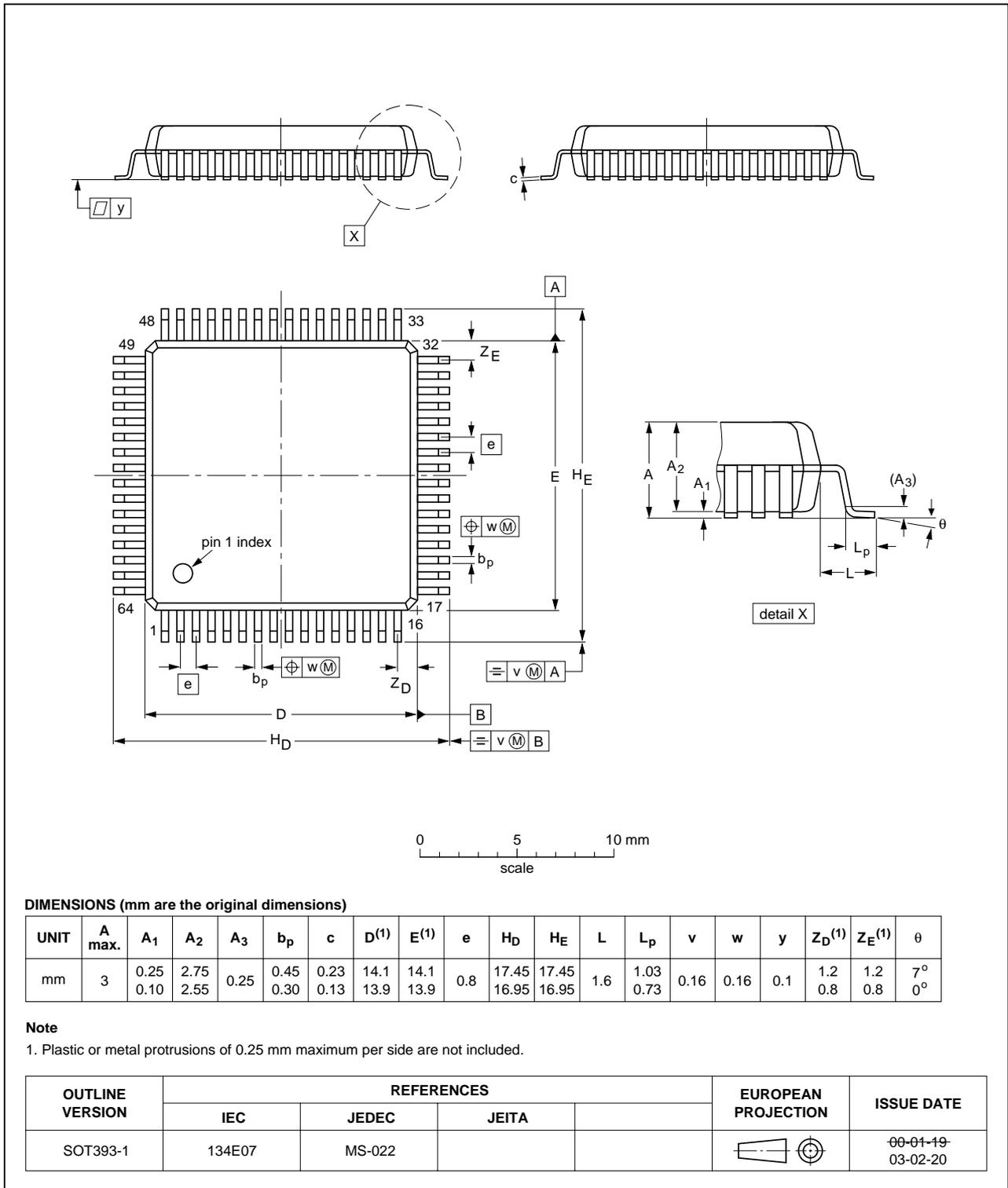

Fig 44. Package outline SOT393-1 (QFP64)

17. Soldering

17.1 Introduction to soldering surface mount packages

There is no soldering method that is ideal for all surface mount IC packages. Wave soldering can still be used for certain surface mount ICs, but it is not suitable for fine pitch SMDs. In these situations reflow soldering is recommended.

17.2 Reflow soldering

Reflow soldering requires solder paste (a suspension of fine solder particles, flux and binding agent) to be applied to the printed-circuit board by screen printing, stencilling or pressure-syringe dispensing before package placement. Driven by legislation and environmental forces the worldwide use of lead-free solder pastes is increasing.

Several methods exist for reflowing; for example, convection or convection/infrared heating in a conveyor type oven. Throughput times (preheating, soldering and cooling) vary between 100 seconds and 200 seconds depending on heating method.

Typical reflow temperatures range from 215 °C to 260 °C depending on solder paste material. The peak top-surface temperature of the packages should be kept below:

Table 115. SnPb eutectic process - package peak reflow temperatures (from J-STD-020C July 2004)

Package thickness	Volume mm ³ < 350	Volume mm ³ ≥ 350
< 2.5 mm	240 °C + 0/-5 °C	225 °C + 0/-5 °C
≥ 2.5 mm	225 °C + 0/-5 °C	225 °C + 0/-5 °C

Table 116. Pb-free process - package peak reflow temperatures (from J-STD-020C July 2004)

Package thickness	Volume mm ³ < 350	Volume mm ³ 350 to 2000	Volume mm ³ > 2000
< 1.6 mm	260 °C + 0 °C	260 °C + 0 °C	260 °C + 0 °C
1.6 mm to 2.5 mm	260 °C + 0 °C	250 °C + 0 °C	245 °C + 0 °C
≥ 2.5 mm	250 °C + 0 °C	245 °C + 0 °C	245 °C + 0 °C

Moisture sensitivity precautions, as indicated on packing, must be respected at all times.

17.3 Wave soldering

Conventional single wave soldering is not recommended for surface mount devices (SMDs) or printed-circuit boards with a high component density, as solder bridging and non-wetting can present major problems.

To overcome these problems the double-wave soldering method was specifically developed.

If wave soldering is used the following conditions must be observed for optimal results:

- Use a double-wave soldering method comprising a turbulent wave with high upward pressure followed by a smooth laminar wave.
- For packages with leads on two sides and a pitch (e):

- larger than or equal to 1.27 mm, the footprint longitudinal axis is **preferred** to be parallel to the transport direction of the printed-circuit board;
- smaller than 1.27 mm, the footprint longitudinal axis **must** be parallel to the transport direction of the printed-circuit board.

The footprint must incorporate solder thieves at the downstream end.

- For packages with leads on four sides, the footprint must be placed at a 45° angle to the transport direction of the printed-circuit board. The footprint must incorporate solder thieves downstream and at the side corners.

During placement and before soldering, the package must be fixed with a droplet of adhesive. The adhesive can be applied by screen printing, pin transfer or syringe dispensing. The package can be soldered after the adhesive is cured.

Typical dwell time of the leads in the wave ranges from 3 seconds to 4 seconds at 250 °C or 265 °C, depending on solder material applied, SnPb or Pb-free respectively.

A mildly-activated flux will eliminate the need for removal of corrosive residues in most applications.

17.4 Manual soldering

Fix the component by first soldering two diagonally-opposite end leads. Use a low voltage (24 V or less) soldering iron applied to the flat part of the lead. Contact time must be limited to 10 seconds at up to 300 °C.

When using a dedicated tool, all other leads can be soldered in one operation within 2 seconds to 5 seconds between 270 °C and 320 °C.

17.5 Package related soldering information

Table 117. Suitability of surface mount IC packages for wave and reflow soldering methods

Package ^[1]	Soldering method	
	Wave	Reflow ^[2]
BGA, HTSSON..T ^[3] , LBGA, LFBGA, SQFP, SSOP..T ^[3] , TFBGA, VFBGA, XSON	not suitable	suitable
DHVQFN, HBCC, HBGA, HLQFP, HSO, HSOP, HSQFP, HSSON, HTQFP, HTSSOP, HVQFN, HVSON, SMS	not suitable ^[4]	suitable
PLCC ^[5] , SO, SOJ	suitable	suitable
LQFP, QFP, TQFP	not recommended ^{[5][6]}	suitable
SSOP, TSSOP, VSO, VSSOP	not recommended ^[7]	suitable
CWQCCN..L ^[8] , PMFP ^[9] , WQCCN..L ^[8]	not suitable	not suitable

[1] For more detailed information on the BGA packages refer to the *(LF)BGA Application Note* (AN01026); order a copy from your Philips Semiconductors sales office.

[2] All surface mount (SMD) packages are moisture sensitive. Depending upon the moisture content, the maximum temperature (with respect to time) and body size of the package, there is a risk that internal or external package cracks may occur due to vaporization of the moisture in them (the so called popcorn effect). For details, refer to the Drypack information in the *Data Handbook IC26; Integrated Circuit Packages; Section: Packing Methods*.

- [3] These transparent plastic packages are extremely sensitive to reflow soldering conditions and must on no account be processed through more than one soldering cycle or subjected to infrared reflow soldering with peak temperature exceeding $217\text{ °C} \pm 10\text{ °C}$ measured in the atmosphere of the reflow oven. The package body peak temperature must be kept as low as possible.
- [4] These packages are not suitable for wave soldering. On versions with the heatsink on the bottom side, the solder cannot penetrate between the printed-circuit board and the heatsink. On versions with the heatsink on the top side, the solder might be deposited on the heatsink surface.
- [5] If wave soldering is considered, then the package must be placed at a 45° angle to the solder wave direction. The package footprint must incorporate solder thieves downstream and at the side corners.
- [6] Wave soldering is suitable for LQFP, QFP and TQFP packages with a pitch (e) larger than 0.8 mm; it is definitely not suitable for packages with a pitch (e) equal to or smaller than 0.65 mm.
- [7] Wave soldering is suitable for SSOP, TSSOP, VSO and VSSOP packages with a pitch (e) equal to or larger than 0.65 mm; it is definitely not suitable for packages with a pitch (e) equal to or smaller than 0.5 mm.
- [8] Image sensor packages in principle should not be soldered. They are mounted in sockets or delivered pre-mounted on flex foil. However, the image sensor package can be mounted by the client on a flex foil by using a hot bar soldering process. The appropriate soldering profile can be provided on request.
- [9] Hot bar soldering or manual soldering is suitable for PMFP packages.

18. Revision history

Table 118. Revision history

Document ID	Release date	Data sheet status	Change notice	Supersedes
TEF6901A_2	20060710	Product data sheet	-	TEF6901A_1
Modifications:	<ul style="list-style-type: none"> • Table 22: added row 1Fh • Section 8.2.27: changed 1Fh to 1Eh in table titles • Section 8.2.28: added • Table 110: AM demodulator output pin MPXAMOUT specification: changed values of V_o • Table 111: stereo decoder and AM path specification: changed value of $V_{o(AM)}$ 			
TEF6901A_1	20060202	Preliminary data sheet	-	-

19. Legal information

19.1 Data sheet status

Document status ^{[1][2]}	Product status ^[3]	Definition
Objective [short] data sheet	Development	This document contains data from the objective specification for product development.
Preliminary [short] data sheet	Qualification	This document contains data from the preliminary specification.
Product [short] data sheet	Production	This document contains the product specification.

[1] Please consult the most recently issued document before initiating or completing a design.

[2] The term 'short data sheet' is explained in section "Definitions".

[3] The product status of device(s) described in this document may have changed since this document was published and may differ in case of multiple devices. The latest product status information is available on the Internet at URL <http://www.semiconductors.philips.com>.

19.2 Definitions

Draft — The document is a draft version only. The content is still under internal review and subject to formal approval, which may result in modifications or additions. Philips Semiconductors does not give any representations or warranties as to the accuracy or completeness of information included herein and shall have no liability for the consequences of use of such information.

Short data sheet — A short data sheet is an extract from a full data sheet with the same product type number(s) and title. A short data sheet is intended for quick reference only and should not be relied upon to contain detailed and full information. For detailed and full information see the relevant full data sheet, which is available on request via the local Philips Semiconductors sales office. In case of any inconsistency or conflict with the short data sheet, the full data sheet shall prevail.

19.3 Disclaimers

General — Information in this document is believed to be accurate and reliable. However, Philips Semiconductors does not give any representations or warranties, expressed or implied, as to the accuracy or completeness of such information and shall have no liability for the consequences of use of such information.

Right to make changes — Philips Semiconductors reserves the right to make changes to information published in this document, including without limitation specifications and product descriptions, at any time and without notice. This document supersedes and replaces all information supplied prior to the publication hereof.

Suitability for use — Philips Semiconductors products are not designed, authorized or warranted to be suitable for use in medical, military, aircraft, space or life support equipment, nor in applications where failure or malfunction of a Philips Semiconductors product can reasonably be expected

to result in personal injury, death or severe property or environmental damage. Philips Semiconductors accepts no liability for inclusion and/or use of Philips Semiconductors products in such equipment or applications and therefore such inclusion and/or use is at the customer's own risk.

Applications — Applications that are described herein for any of these products are for illustrative purposes only. Philips Semiconductors makes no representation or warranty that such applications will be suitable for the specified use without further testing or modification.

Limiting values — Stress above one or more limiting values (as defined in the Absolute Maximum Ratings System of IEC 60134) may cause permanent damage to the device. Limiting values are stress ratings only and operation of the device at these or any other conditions above those given in the Characteristics sections of this document is not implied. Exposure to limiting values for extended periods may affect device reliability.

Terms and conditions of sale — Philips Semiconductors products are sold subject to the general terms and conditions of commercial sale, as published at <http://www.semiconductors.philips.com/profile/terms>, including those pertaining to warranty, intellectual property rights infringement and limitation of liability, unless explicitly otherwise agreed to in writing by Philips Semiconductors. In case of any inconsistency or conflict between information in this document and such terms and conditions, the latter will prevail.

No offer to sell or license — Nothing in this document may be interpreted or construed as an offer to sell products that is open for acceptance or the grant, conveyance or implication of any license under any copyrights, patents or other industrial or intellectual property rights.

19.4 Trademarks

Notice: All referenced brands, product names, service names and trademarks are the property of their respective owners.

I²C-bus — logo is a trademark of Koninklijke Philips Electronics N.V.

20. Contact information

For additional information, please visit: <http://www.semiconductors.philips.com>

For sales office addresses, send an email to: sales.addresses@www.semiconductors.philips.com

21. Contents

1	General description	1	8.1	Read mode	13
2	Features	1	8.1.1	Read mode: data byte IFCOUNTER	14
3	Quick reference data	2	8.1.2	Read mode: data byte LEVEL	16
4	Ordering information	3	8.1.3	Read mode: data byte USN/WAM	17
5	Block diagram	4	8.1.4	Read mode: data byte MOD	18
6	Pinning information	5	8.1.5	Read mode: data byte IFBW	20
6.1	Pinning	5	8.1.6	Read mode: data byte ID	20
6.2	Pin description	5	8.1.7	Read mode: data byte TEMP	21
7	Functional description	7	8.2	Write mode	21
7.1	FM mixer 1	7	8.2.1	Mode and subaddress byte for write	27
7.2	FM RF AGC	7	8.2.2	Write mode: data byte BANDWIDTH	34
7.3	FM mixer 2	7	8.2.3	Write mode: data bytes PLLM and PLLL	36
7.4	FM IF2 channel filter	7	8.2.4	Write mode: data byte DAA	36
7.5	FM limiter and level detection	8	8.2.5	Write mode: data byte AGC	37
7.6	FM demodulator	8	8.2.6	Write mode: data byte BAND	38
7.7	Center frequency and bandwidth tuning and center frequency DAA	8	8.2.7	Tuning overview	39
7.8	Bandwidth control algorithm	8	8.2.8	Write mode: data byte LEVELALGN	40
7.9	VCO and dividers	8	8.2.9	Write mode: data byte IFCF	40
7.10	Crystal oscillator	8	8.2.10	Write mode: data byte IFCAP	40
7.11	Tuning PLL	8	8.2.10.1	Factory alignment of bits IFCAP[3:0]	41
7.12	Antenna DAA	9	8.2.10.2	Initialization of the radio	41
7.13	AM RF AGC control	9	8.2.10.3	Factory alignment of IFCF	41
7.14	AM mixer 1	9	8.2.11	Write mode: data byte ACD	42
7.15	AM IF noise blanker	9	8.2.12	Write mode: data byte SENSE	42
7.16	AM IF AGC amplifier and demodulator	9	8.2.13	Write mode: data byte TIMING	44
7.17	AM level detection	9	8.2.14	Write mode: data byte SNC	45
7.18	AM and FM level DAA	9	8.2.15	Write mode: data byte HIGHCUT	47
7.19	AM and FM IF counter	9	8.2.16	Write mode: data byte SOFTMUTE	50
7.20	Tuning mute	9	8.2.17	Write mode: data byte RADIO	54
7.21	FM stereo decoder	10	8.2.18	Write mode: data byte INPUT	56
7.22	FM and AM AF noise blanker	10	8.2.19	Write mode: data byte VOLUME	58
7.23	Fixed high cut and high cut control	10	8.2.20	Write mode: data byte TREBLE	65
7.24	De-emphasis	10	8.2.21	Write mode: data byte BASS	66
7.25	Weak signal processing	10	8.2.22	Write mode: data byte FADER	68
7.26	Audio step interpolation	11	8.2.23	Write mode: data byte OUTPUT	68
7.27	Source selector	11	8.2.24	Write mode: data byte BALANCE	69
7.28	VU-meter read	11	8.2.25	Write mode: data byte LOUDNESS	69
7.29	Volume and balance	11	8.2.26	Write mode: data byte POWER	72
7.30	CD compression	11	8.2.27	Write mode: data bytes RESERVED	72
7.31	Bass	12	8.2.28	Write mode: data byte TEST	73
7.32	Treble	12	9	Limiting values	73
7.33	Loudness	12	10	Thermal characteristics	74
7.34	Fader	12	11	Static characteristics	74
7.35	RDS/RBDS demodulator	12	12	Dynamic characteristics	76
8	I²C-bus protocol	12	12.1	Dynamic characteristics of the tuner	76
			12.2	Dynamic characteristics of the sound processor	85

continued >>

13	I²C-bus characteristics	96
14	Overall system parameters	98
15	Application information	99
16	Package outline	101
17	Soldering	102
17.1	Introduction to soldering surface mount packages	102
17.2	Reflow soldering	102
17.3	Wave soldering	102
17.4	Manual soldering	103
17.5	Package related soldering information	103
18	Revision history	104
19	Legal information	105
19.1	Data sheet status	105
19.2	Definitions	105
19.3	Disclaimers	105
19.4	Trademarks	105
20	Contact information	105
21	Contents	106



Please be aware that important notices concerning this document and the product(s) described herein, have been included in section 'Legal information'.

© Koninklijke Philips Electronics N.V. 2006. All rights reserved.

For more information, please visit: <http://www.semiconductors.philips.com>.

For sales office addresses, email to: sales.addresses@www.semiconductors.philips.com.

Date of release: 10 July 2006

Document identifier: TEF6901A_2