

FGP90N30

300V, 90A PDP IGBT

Features

- High Current Capability
- Low saturation voltage : $V_{CE(sat)} = 1.1\text{ V @ } I_C = 20\text{ A}$
- High input impedance
- Fast switching

General Description

Employing Unified IGBT Technology, Fairchild's PDP IGBTs provides low conduction and switching loss. The PWD series offers the optimum solution for PDP applications where low - conduction loss is essential.

Application

- . PDP System

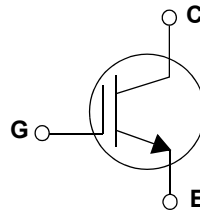
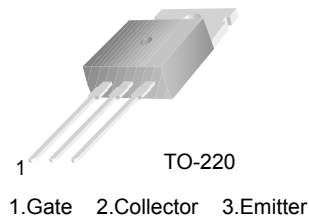

Absolute Maximum Ratings

Symbol	Description	FGP90N30	Units
V_{CES}	Collector-Emitter Voltage	300	V
V_{GES}	Gate-Emitter Voltage	± 20	V
I_C	Collector Current @ $T_C = 25^\circ\text{C}$	90	A
$I_{C_pulse(1)}$	Pulse Collector Current @ $T_C = 25^\circ\text{C}$	130	A
P_D	Maximum Power Dissipation @ $T_C = 25^\circ\text{C}$	192	W
	Maximum Power Dissipation @ $T_C = 100^\circ\text{C}$	77	W
T_J	Operating Junction Temperature	-55 to +150	$^\circ\text{C}$
T_{stg}	Storage Temperature Range	-55 to +150	$^\circ\text{C}$
T_L	Maximum Lead Temp. for soldering Purposes, 1/8" from case for 5 seconds	300	$^\circ\text{C}$

Thermal Characteristics

Symbol	Parameter	Typ.	Max.	Units
$R_{\theta JC}$ (IGBT)	Thermal Resistance, Junction-to-Case	--	0.65	$^\circ\text{C/W}$
$R_{\theta JA}$	Thermal Resistance, Junction-to-Ambient	--	62.5	$^\circ\text{C/W}$

Notes

- (1) Repetitive test , pulse width=100usec , Duty=0.5

Package Marking and Ordering Information

Device Marking	Device	Package	Packaging Type	Qty per Tube	Max Qty per Box
FGP90N30	FGP90N30TU	TO-220	Rail / Tube	50ea	-

Electrical Characteristics T_C = 25°C unless otherwise noted

Symbol	Parameter	Test Conditions	Min.	Typ.	Max.	Units
--------	-----------	-----------------	------	------	------	-------

Off Characteristics

BV _{CES}	Collector-Emitter Breakdown Voltage	V _{GE} = 0V, I _C = 250uA	300	--	--	V
ΔBV _{CES} /ΔT _J	Temperature Coefficient of Breakdown Voltage	V _{GE} = 0V, I _C = 250uA	--	0.6	--	V/°C
I _{CES}	Collector Cut-Off Current	V _{CE} = V _{CES} , V _{GE} = 0V	--	--	100	uA
I _{GES}	G-E Leakage Current	V _{GE} = V _{GES} , V _{CE} = 0V	--	--	± 250	nA

On Characteristics

V _{GE(th)}	G-E Threshold Voltage	I _C = 250uA, V _{CE} = V _{GE}	2.5	4.0	5.0	V
V _{CE(sat)}	Collector to Emitter Saturation Voltage	I _C = 20A, V _{GE} = 15V	--	1.1	1.4	V
		I _C = 90 A, V _{GE} = 15V T _C = 25°C	--	1.9	--	V
		I _C = 90 A, V _{GE} = 15V T _C = 125°C	--	2.0	--	V

Dynamic Characteristics

C _{ies}	Input Capacitance	V _{CE} = 30V, V _{GE} = 0V, f = 1MHz	--	1700	--	pF
C _{oes}	Output Capacitance		--	290	--	pF
C _{res}	Reverse Transfer Capacitance		--	80	--	pF

Switching Characteristics

t _{d(on)}	Turn-On Delay Time	V _{CC} = 200 V, I _C = 20A, R _G = 10Ω, V _{GE} = 15V, Resistive Load, T _C = 25°C	--	30	--	ns
t _r	Rise Time		--	150	--	ns
t _{d(off)}	Turn-Off Delay Time		--	110	--	ns
t _f	Fall Time		--	140	350	ns
t _{d(on)}	Turn-On Delay Time	V _{CC} = 200 V, I _C = 20 A, R _G = 10Ω, V _{GE} = 15V, Resistive Load, T _C = 125°C	--	30	--	ns
t _r	Rise Time		--	150	--	ns
t _{d(off)}	Turn-Off Delay Time		--	110	--	ns
t _f	Fall Time		--	330	--	ns
Q _g	Total Gate Charge	V _{CE} = 200 V, I _C = 20A, V _{GE} = 15V	--	87	130	nC
Q _{ge}	Gate-Emitter Charge		--	12	18	nC
Q _{gc}	Gate-Collector Charge		--	38	57	nC

Typical Performance Characteristics

Figure 1. Typical Output Characteristics

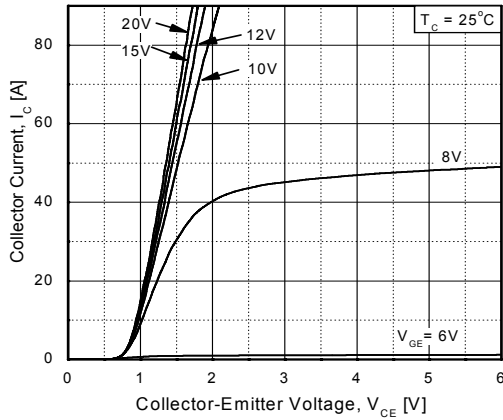

Figure 2. Typical Output Characteristics

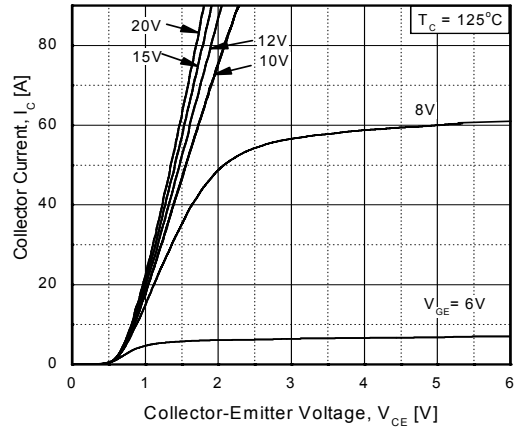

Figure 3 Typical Saturation Voltage Characteristics

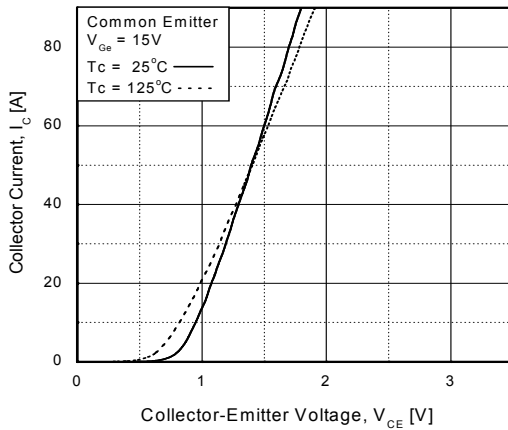

Figure 4. Transfer Characteristics

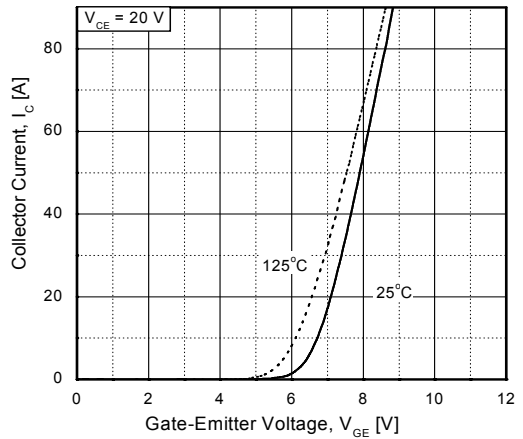

Figure 5. Saturation Voltage vs Case Temperature at Variant Current Level

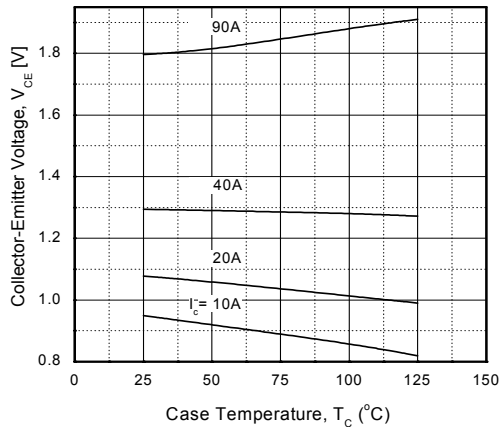

Figure 6. Saturation Voltage vs. Vge

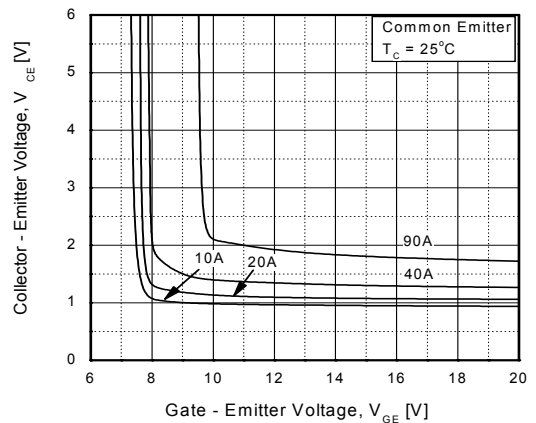

Figure 7. Saturation Voltage vs. V_{ge}

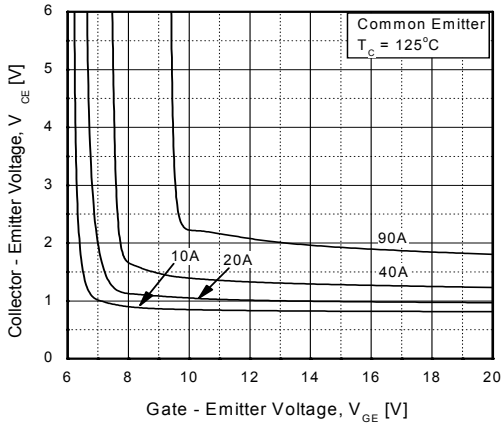

Figure 8. Capacitance Characteristics

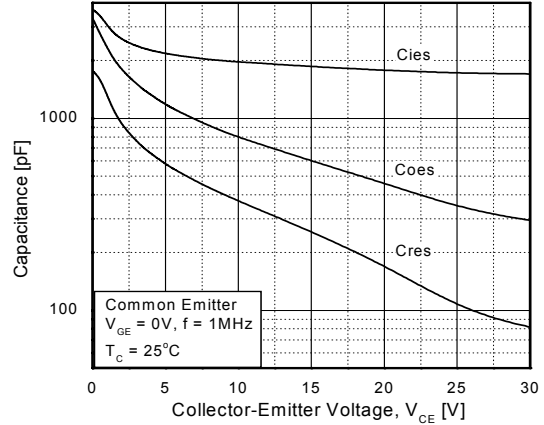

Figure 9. Gate Charge

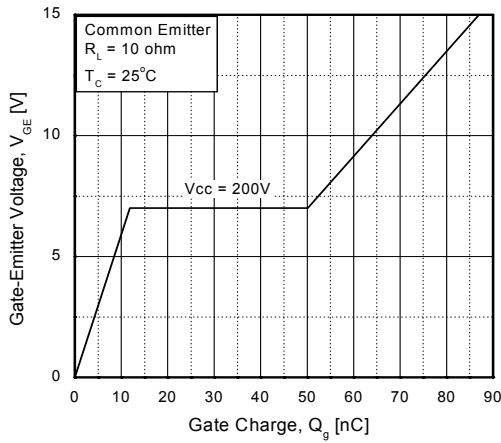

Figure 10. SOA Characteristics

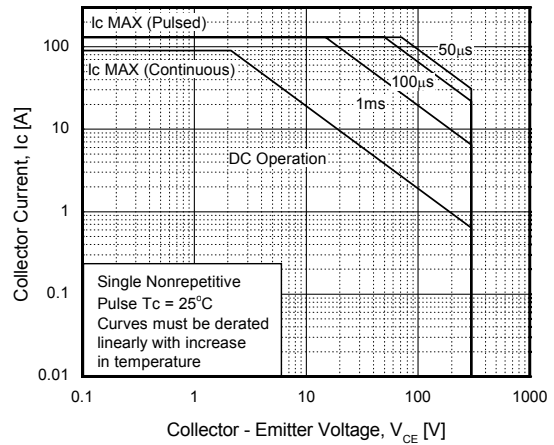

Figure 11. Turn-On Characteristics vs. Gate Resistance

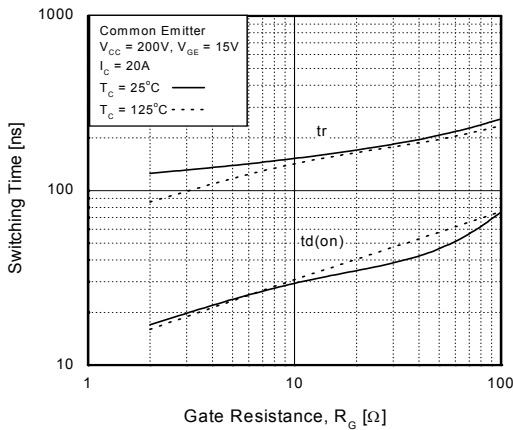

Figure 12. Turn-Off Characteristics vs. Gate Resistance

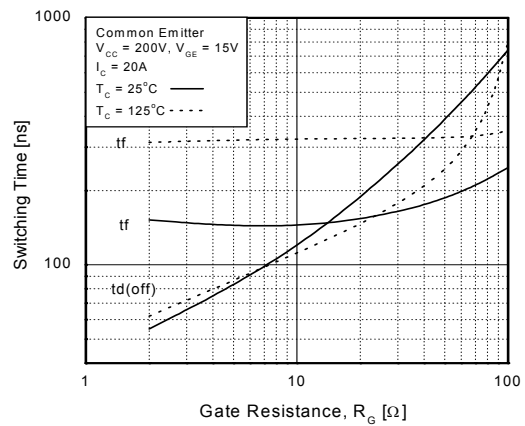

Figure 13 Turn-On Characteristics vs. Collector Current

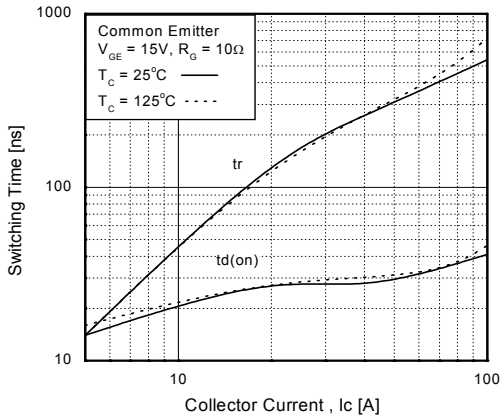

Figure 14. Turn-Off Characteristics vs. Collector Current

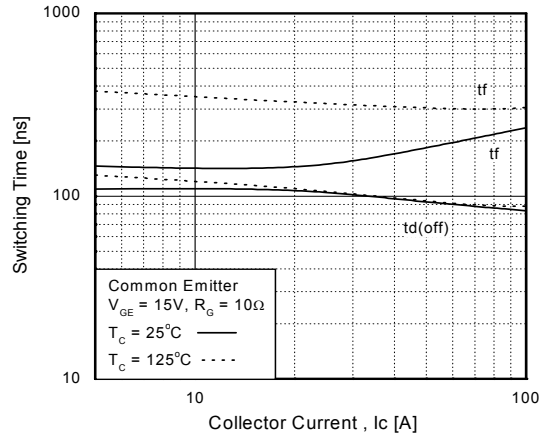

Figure 15. Switching Loss vs. Gate Resistance

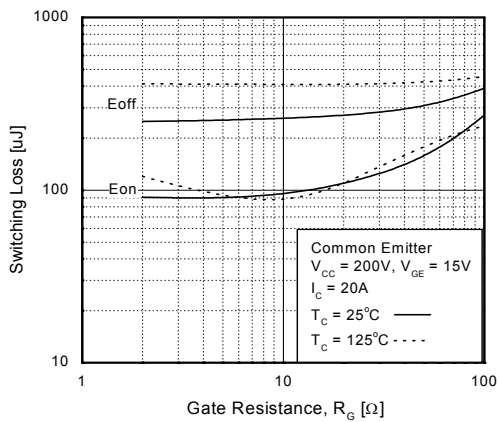

Figure 16. Switching Loss vs. Collector Current

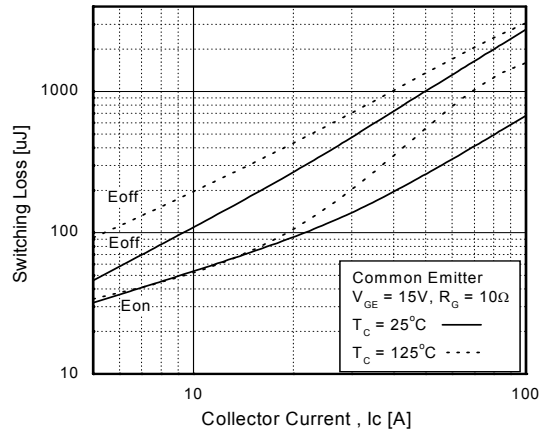
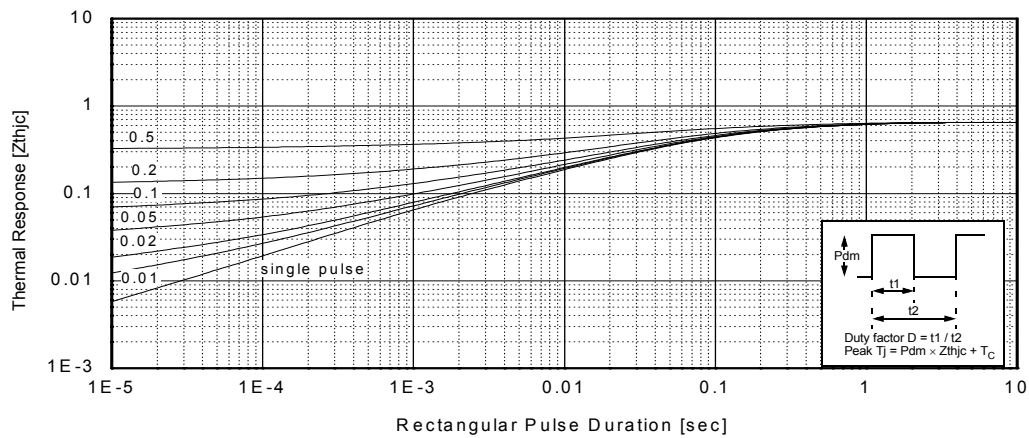
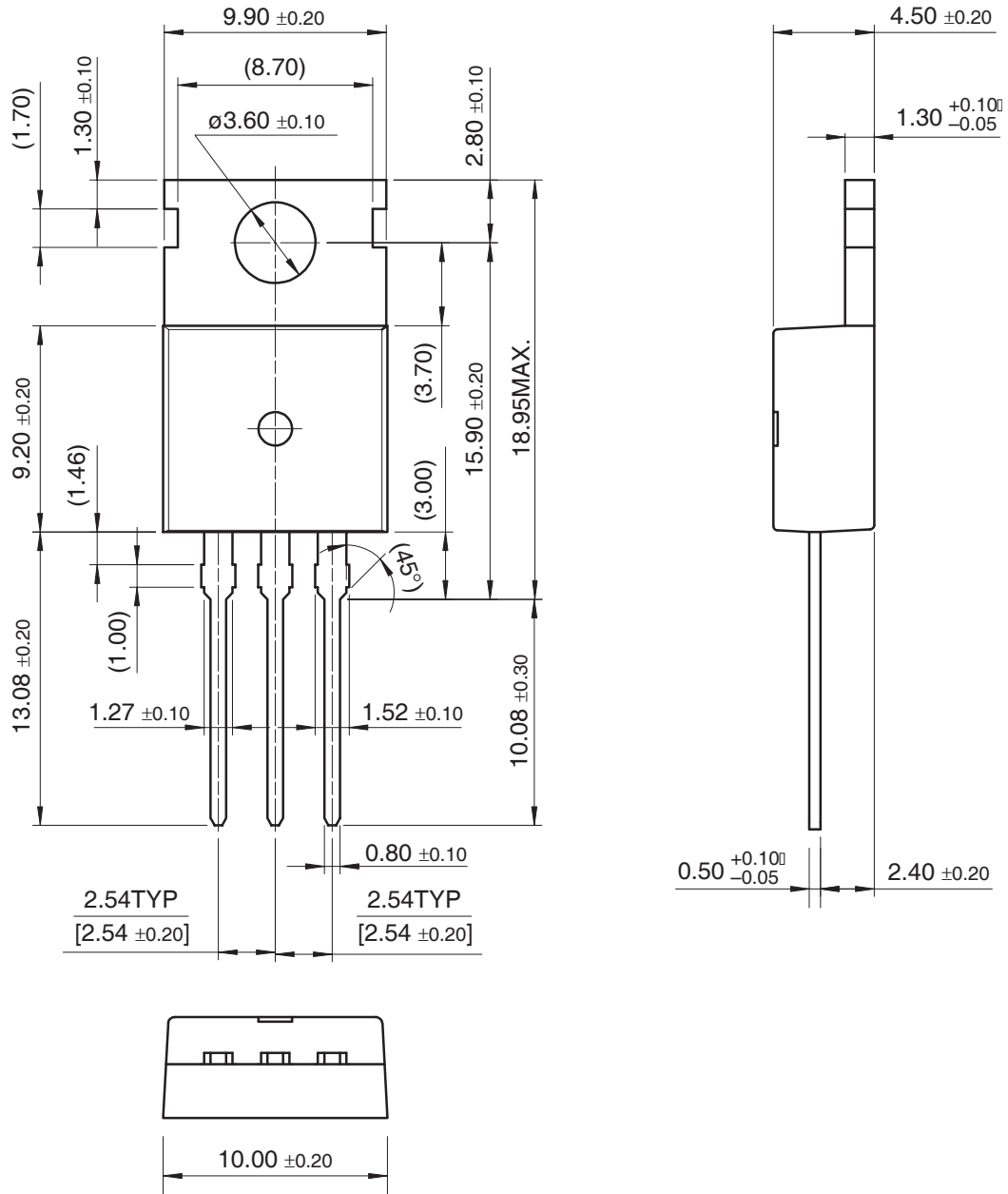

Figure 17. Transient Thermal Impedance of IGBT



Mechanical Dimensions

TO-220



TRADEMARKS

The following are registered and unregistered trademarks Fairchild Semiconductor owns or is authorized to use and is not intended to be an exhaustive list of all such trademarks.

ACEx™	FAST®	ISOPLANAR™	PowerSaver™	SuperSOT™-6
ActiveArray™	FASTr™	LittleFET™	PowerTrench®	SuperSOT™-8
Bottomless™	FPS™	MICROCOUPLER™	QFET®	SyncFET™
Build it Now™	FRFET™	MicroFET™	QS™	TinyLogic®
CoolFET™	GlobalOptoisolator™	MicroPak™	QT Optoelectronics™	TINYOPTO™
CROSSVOLT™	GTO™	MICROWIRE™	Quiet Series™	TruTranslation™
DOME™	HiSeC™	MSX™	RapidConfigure™	UHC™
EcoSPARK™	I ² C™	MSXPro™	RapidConnect™	UltraFET®
E ² CMOS™	i-Lo™	OCX™	µSerDes™	UniFET™
EnSigna™	ImpliedDisconnect™	OCXPro™	ScalarPump™	VCX™
FACT™	IntelliMAX™	OPTOLOGIC®	SILENT SWITCHER®	Wire™
FACT Quiet Series™		OPTOPLANAR™	SMART START™	
		PACMAN™	SPM™	
Across the board. Around the world.™		POP™	Stealth™	
The Power Franchise®		Power247™	SuperFET™	
Programmable Active Droop™		PowerEdge™	SuperSOT™-3	

DISCLAIMER

FAIRCHILD SEMICONDUCTOR RESERVES THE RIGHT TO MAKE CHANGES WITHOUT FURTHER NOTICE TO ANY PRODUCTS HEREIN TO IMPROVE RELIABILITY, FUNCTION OR DESIGN. FAIRCHILD DOES NOT ASSUME ANY LIABILITY ARISING OUT OF THE APPLICATION OR USE OF ANY PRODUCT OR CIRCUIT DESCRIBED HEREIN; NEITHER DOES IT CONVEY ANY LICENSE UNDER ITS PATENT RIGHTS, NOR THE RIGHTS OF OTHERS.

LIFE SUPPORT POLICY

FAIRCHILD'S PRODUCTS ARE NOT AUTHORIZED FOR USE AS CRITICAL COMPONENTS IN LIFE SUPPORT DEVICES OR SYSTEMS WITHOUT THE EXPRESS WRITTEN APPROVAL OF FAIRCHILD SEMICONDUCTOR CORPORATION.

As used herein:

- Life support devices or systems are devices or systems which, (a) are intended for surgical implant into the body, or (b) support or sustain life, or (c) whose failure to perform when properly used in accordance with instructions for use provided in the labeling, can be reasonably expected to result in significant injury to the user.
- A critical component is any component of a life support device or system whose failure to perform can be reasonably expected to cause the failure of the life support device or system, or to affect its safety or effectiveness.

PRODUCT STATUS DEFINITIONS

Definition of Terms

Datasheet Identification	Product Status	Definition
Advance Information	Formative or In Design	This datasheet contains the design specifications for product development. Specifications may change in any manner without notice.
Preliminary	First Production	This datasheet contains preliminary data, and supplementary data will be published at a later date. Fairchild Semiconductor reserves the right to make changes at any time without notice in order to improve design.
No Identification Needed	Full Production	This datasheet contains final specifications. Fairchild Semiconductor reserves the right to make changes at any time without notice in order to improve design.
Obsolete	Not In Production	This datasheet contains specifications on a product that has been discontinued by Fairchild semiconductor. The datasheet is printed for reference information only.

Rev. 117

FGP90N30TU	Full Production		\$2.52	TO-220	3	RAIL	Line 1: \$Y (Fairchild logo) &Z (Asm. Plant Code) &E&3 (3-Digit Date Code) Line 2: FGP Line 3: 90N30
------------	-----------------	---	--------	------------------------	---	------	---

* Fairchild 1,000 piece Budgetary Pricing

** A sample button will appear if the part is available through Fairchild's on-line samples program. If there is no sample button, please contact a [Fairchild distributor](#) to obtain samples



Indicates product with Pb-free second-level interconnect. For more information [click here](#).

Package marking information for product FGP90N30 is available. [Click here for more information](#).

[back to top](#)

Qualification Support

Click on a product for detailed qualification data

Product
FGP90N30TU

[back to top](#)

© 2007 Fairchild Semiconductor

