

FEATURES

**High accuracy over line and load: $\pm 0.8\%$ @ 25°C ,
 $\pm 1.4\%$ over temperature**
Ultralow dropout voltage: 190 mV (typ) @ 1 A
Requires only $C_O = 1.0 \mu\text{F}$ for stability
anyCAP is stable with any type of capacitor (including MLCC)
Current and thermal limiting
Low noise
2.7 V to 8 V supply range
 -40°C to $+85^\circ\text{C}$ ambient temperature range
SOT-223 package

APPLICATIONS

Notebook, palmtop computers
SCSI terminators
Battery-powered systems
Bar code scanners
Camcorders, cameras
Home entertainment systems
Networking systems
DSP/ASIC supplies

GENERAL DESCRIPTION

The ADP3338 is a member of the ADP33xx family of precision, low dropout (LDO), anyCAP voltage regulators. The ADP3338 operates with an input voltage range of 2.7 V to 8 V and delivers a load current up to 1 A. The ADP3338 stands out from conventional LDOs with a novel architecture and an enhanced process that offers performance advantages and higher output current than its competition. Its patented design requires only a $1 \mu\text{F}$ output capacitor for stability. This device is insensitive to output capacitor equivalent series resistance (ESR), and is stable

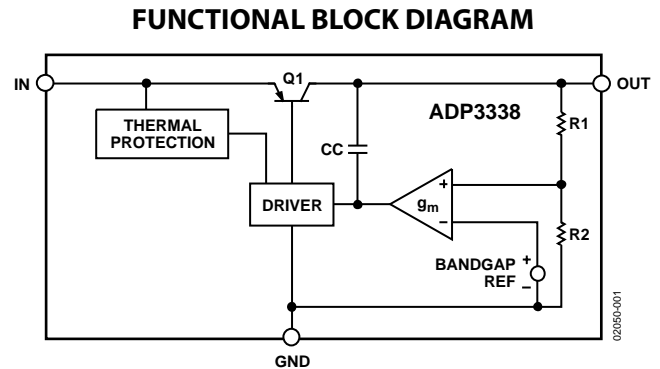

Figure 1.

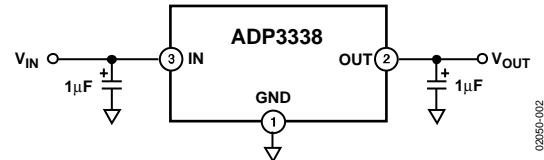

Figure 2. Typical Application Circuit

with any good quality capacitor, including ceramic (MLCC) types for space-restricted applications. The ADP3338 achieves exceptional accuracy of $\pm 0.8\%$ at room temperature and $\pm 1.4\%$ over temperature, line, and load variations. The dropout voltage of the ADP3338 is only 190 mV (typical) at 1 A. The device also includes a safety current limit and thermal overload protection. The ADP3338 has ultralow quiescent current: 110 μA (typical) in light load situations.

Rev. B

Information furnished by Analog Devices is believed to be accurate and reliable. However, no responsibility is assumed by Analog Devices for its use, nor for any infringements of patents or other rights of third parties that may result from its use. Specifications subject to change without notice. No license is granted by implication or otherwise under any patent or patent rights of Analog Devices. Trademarks and registered trademarks are the property of their respective owners.

TABLE OF CONTENTS

Specifications.....	3	Capacitor Selection	10
Absolute Maximum Ratings.....	4	Output Current Limit	10
ESD Caution.....	4	Thermal Overload Protection	10
Pin Configuration and Function Descriptions.....	5	Calculating Power Dissipation	10
Typical Performance Characteristics	6	Printed Circuit Board Layout Considerations	10
Theory of Operation	9	Outline Dimensions	12
Application Information.....	10	Ordering Guide	13

REVISION HISTORY

6/05—Data Sheet Changed from Rev. A to Rev. B

Added Pin Function Descriptions Table	5
Changes to Ordering Guide	13

6/04—Data Sheet Changed from Rev. 0 to Rev. A

Updated Format.....	Universal
Changes to Figures 5, 11, 12, 13, 14, 15	6
Updated Outline Dimensions	12
Changes to Ordering Guide	12

6/01—Rev. 0: Initial Version

SPECIFICATIONS

$V_{IN} = 6.0\text{ V}$, $C_{IN} = C_{OUT} = 1\ \mu\text{F}$, $T_J = -40^\circ\text{C}$ to $+125^\circ\text{C}$, unless otherwise noted.

Table 1.

Parameter ^{1, 2, 3}	Symbol	Conditions	Min	Typ	Max	Unit
OUTPUT						
Voltage Accuracy	V_{OUT}	$V_{IN} = V_{OUTNOM} + 0.4\text{ V}$ to 8 V , $I_L = 0.1\text{ mA}$ to 1 A , $T_J = 25^\circ\text{C}$	-0.8		+0.8	%
		$V_{IN} = V_{OUTNOM} + 0.4\text{ V}$ to 8 V , $I_L = 0.1\text{ mA}$ to 1 A , $T_J = -40^\circ\text{C}$ to $+125^\circ\text{C}$	-1.4		+1.4	%
		$V_{IN} = V_{OUTNOM} + 0.4\text{ V}$ to 8 V , $I_L = 50\text{ mA}$ to 1 A , $T_J = 150^\circ\text{C}$	-1.6		+1.6	%
Line Regulation		$V_{IN} = V_{OUTNOM} + 0.4\text{ V}$ to 8 V , $T_J = 25^\circ\text{C}$		0.04		mV/V
Load Regulation		$I_L = 0.1\text{ mA}$ to 1 A , $T_J = 25^\circ\text{C}$		0.006		mV/mA
Dropout Voltage	V_{DROP}	$V_{OUT} = 98\%$ of V_{OUTNOM}				
		$I_L = 1\text{ A}$		190	400	mV
		$I_L = 500\text{ mA}$		125	200	mV
		$I_L = 100\text{ mA}$		70	150	mV
Peak Load Current	I_{LDPK}	$V_{IN} = V_{OUTNOM} + 1\text{ V}$		1.6		A
Output Noise	V_{NOISE}	$f = 10\text{ Hz}$ to 100 kHz , $C_L = 10\ \mu\text{F}$, $I_L = 1\text{ A}$		95		$\mu\text{V rms}$
GROUND CURRENT						
In Regulation	I_{GND}	$I_L = 1\text{ A}$		9	30	mA
		$I_L = 500\text{ mA}$		4.5	15	mA
		$I_L = 100\text{ mA}$		0.9	3	mA
		$I_L = 0.1\text{ mA}$		110	190	μA
In Dropout	I_{GND}	$V_{IN} = V_{OUTNOM} - 100\text{ mV}$, $I_L = 0.1\text{ mA}$		190	600	μA

¹ All limits at temperature extremes are guaranteed via correlation using standard statistical quality control (SQC) methods.

² Application stable with no load.

³ $V_{IN} = 2.7\text{ V}$ for models with $V_{OUTNOM} \leq 2.2\text{ V}$.

ADP3338

ABSOLUTE MAXIMUM RATINGS

Unless otherwise specified, all voltages are referenced to GND.

Table 2.

Parameter	Rating
Input Supply Voltage	-0.3 V to +8.5 V
Power Dissipation	Internally limited
Operating Ambient Temperature Range	-40°C to +85°C
Operating Junction Temperature Range	-40°C to +150°C
θ_{JA}	62.3°C/W
θ_{JC}	26.8°C/W
Storage Temperature Range	-65°C to +150°C
Lead Temperature (Soldering 10 sec)	300°C
Vapor Phase (60 sec)	215°C
Infrared (15 sec)	220°C

Stresses above those listed under Absolute Maximum Ratings may cause permanent damage to the device. This is a stress rating only; functional operation of the device at these or any other conditions above those indicated in the operational section of this specification is not implied. Exposure to absolute maximum rating conditions for extended periods may affect device reliability.

Only one absolute maximum rating may be applied at any one time.

ESD CAUTION

ESD (electrostatic discharge) sensitive device. Electrostatic charges as high as 4000 V readily accumulate on the human body and test equipment and can discharge without detection. Although this product features proprietary ESD protection circuitry, permanent damage may occur on devices subjected to high energy electrostatic discharges. Therefore, proper ESD precautions are recommended to avoid performance degradation or loss of functionality.



PIN CONFIGURATION AND FUNCTION DESCRIPTIONS

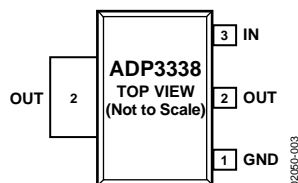

NOTE: PIN 2 AND TAB ARE INTERNALLY CONNECTED

Figure 3. Pin Configuration

Table 3. Pin Function Descriptions

Pin No.	Mnemonic	Description
1	GND	Ground Pin.
2	OUT	Regulator Output. Bypass to ground with a 1 μ F or larger capacitor.
3	IN	Regulator Input. Bypass to ground with a 1 μ F or larger capacitor.

TYPICAL PERFORMANCE CHARACTERISTICS

$T_A = 25^\circ\text{C}$, unless otherwise noted.

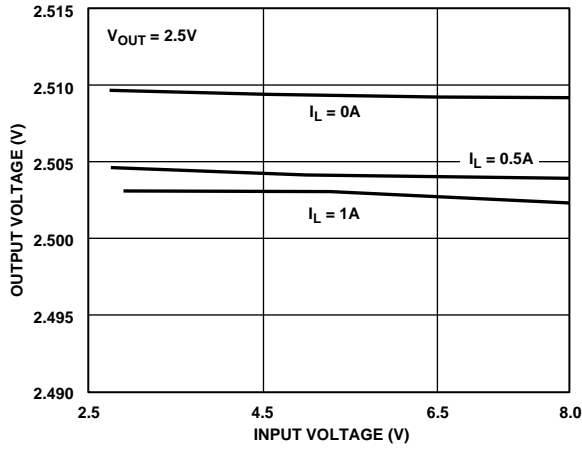

Figure 4. Line Regulation Output Voltage vs. Input Voltage

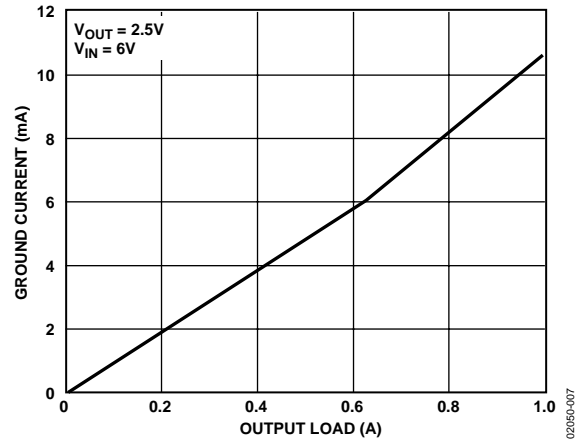

Figure 7. Ground Current vs. Load Current

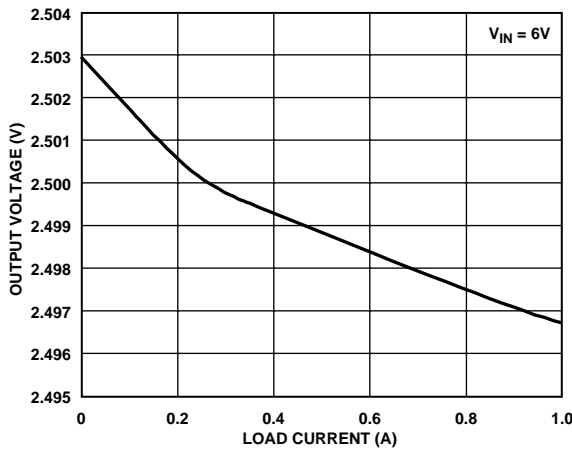

Figure 5. Output Voltage vs. Load Current

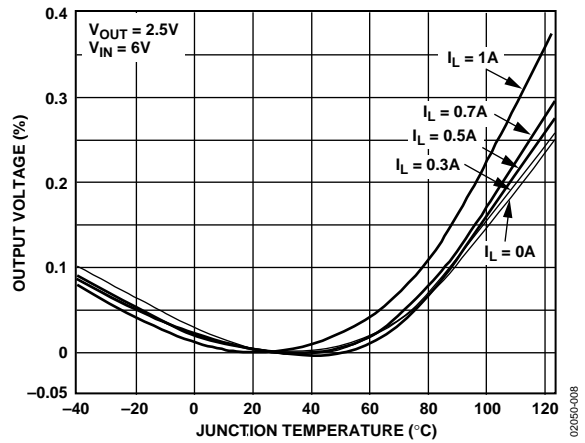

Figure 8. Output Voltage Variation % vs. Junction Temperature

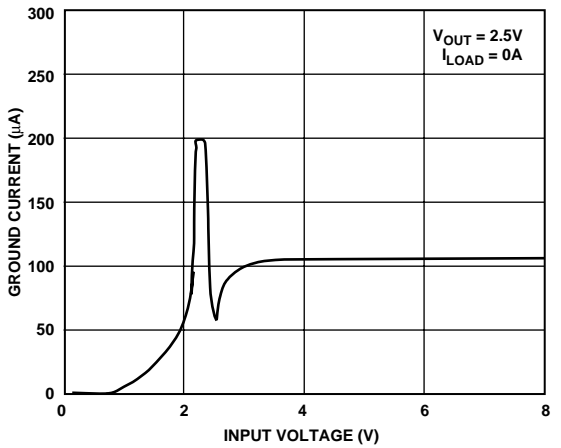

Figure 6. Ground Current vs. Supply Voltage

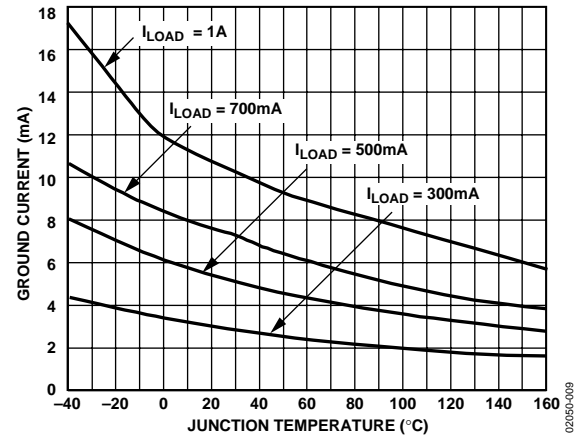

Figure 9. Ground Current vs. Junction Temperature

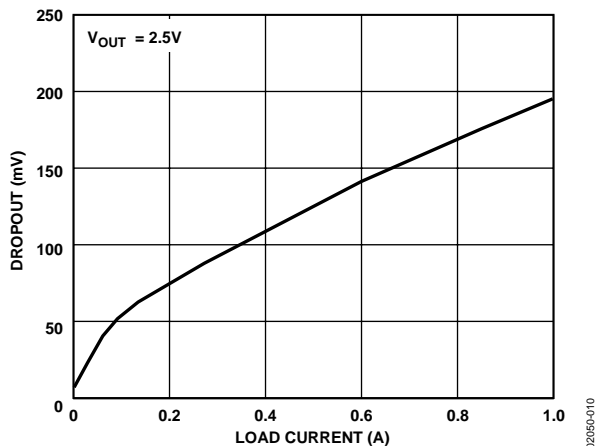

Figure 10. Dropout Voltage vs. Load Current

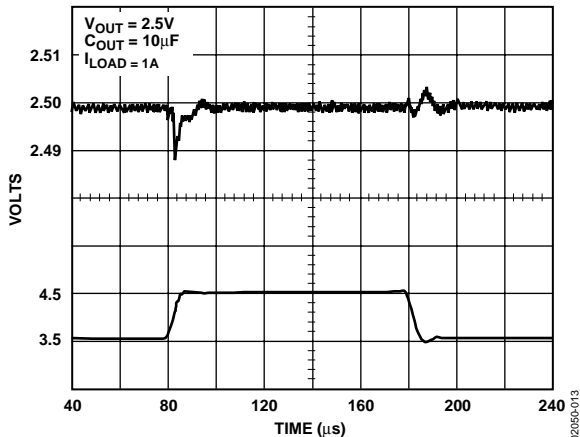

Figure 13. Line Transient Response

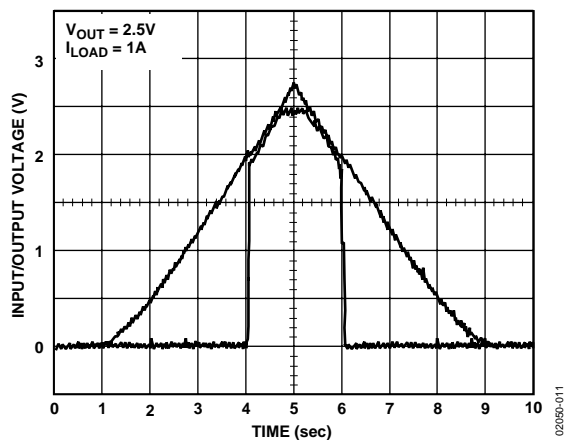

Figure 11. Power-Up/Power-Down

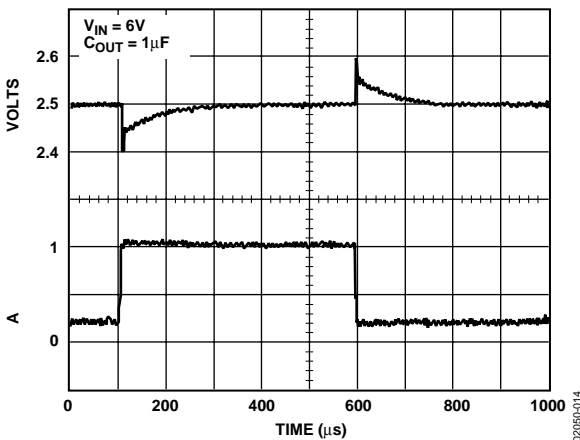

Figure 14. Load Transient Response

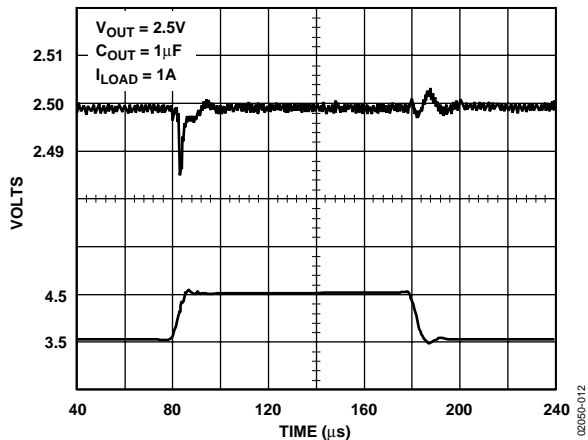

Figure 12. Line Transient Response

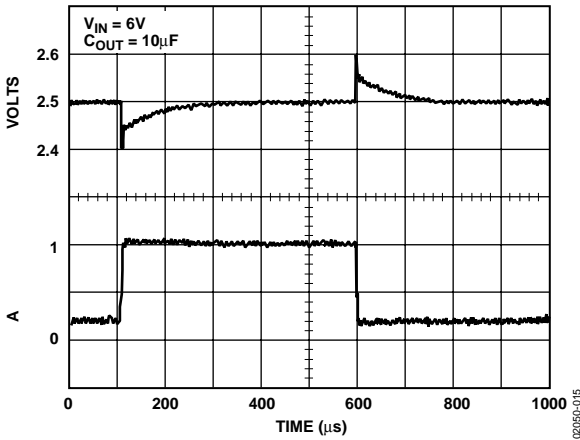

Figure 15. Load Transient Response

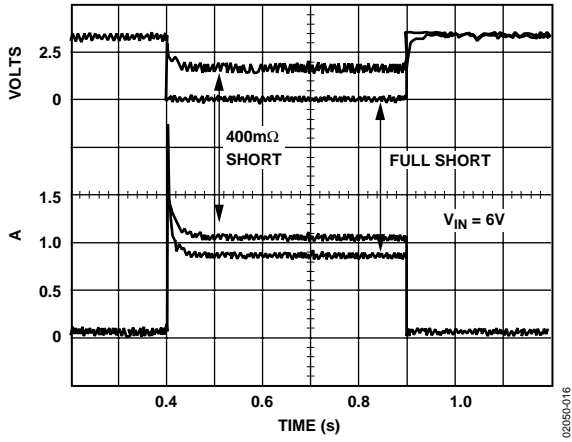

Figure 16. Short-Circuit Current

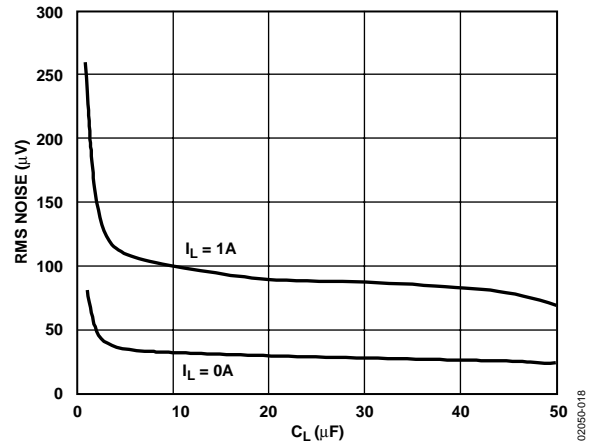

Figure 18. RMS Noise vs. C_L

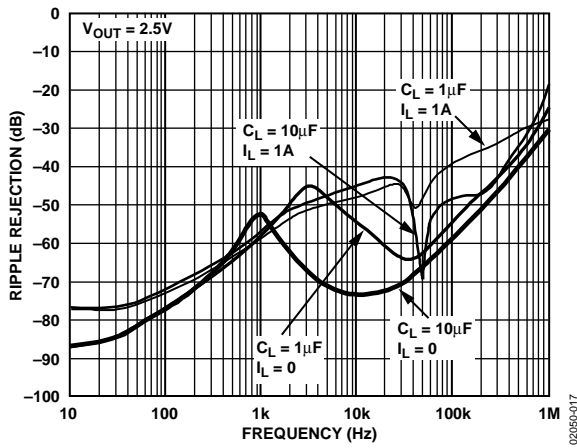

Figure 17. Power Supply Ripple Rejection

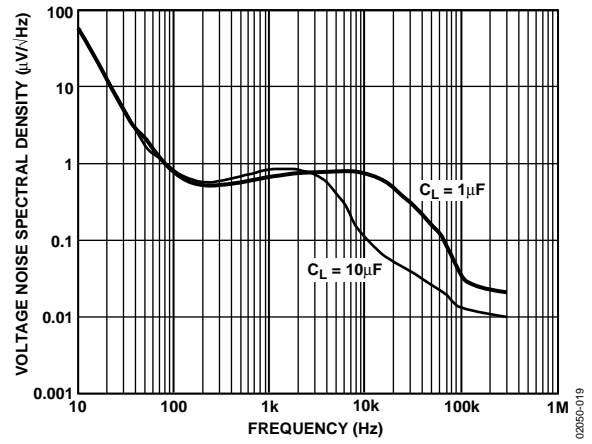

Figure 19. Output Noise Density (10 Hz to 100 kHz)

THEORY OF OPERATION

The ADP3338 anyCAP LDO uses a single control loop for regulation and reference functions. The output voltage is sensed by a resistive voltage divider, consisting of R1 and R2, which is varied to provide the available output voltage option. Feedback is taken from this network by way of a series diode (D1) and a second resistor divider (R3 and R4) to the input of an amplifier.

A very high gain error amplifier is used to control this loop. The amplifier is constructed in such a way that equilibrium produces a large, temperature-proportional input offset voltage that is repeatable and very well controlled. The temperature-proportional offset voltage is combined with the complementary diode voltage to form a virtual band gap voltage that is implicit in the network, although it never appears explicitly in the circuit. Ultimately, this patented design makes it possible to control the loop with only one amplifier. This technique also improves the noise characteristics of the amplifier by providing more flexibility on the trade off of noise sources that leads to a low noise design.

The R1, R2 divider is chosen in the same ratio as the band gap voltage to the output voltage. Although the R1, R2 resistor divider is loaded by Diode D1 and a second divider consisting of R3 and R4, the values can be chosen to produce a temperature-stable output. This unique arrangement specifically corrects for the loading of the divider, thus avoiding the error resulting from base current loading in conventional circuits.

The patented amplifier controls a new and unique noninverting driver that drives the pass transistor, Q1. The use of this special noninverting driver enables the frequency compensation to

include the load capacitor in a pole-splitting arrangement to achieve reduced sensitivity to the value, type, and ESR of the load capacitance.

Most LDOs place very strict requirements on the range of ESR values for the output capacitor because they are difficult to stabilize due to the uncertainty of load capacitance and resistance. Moreover, the ESR value required to keep conventional LDOs stable changes depending on load and temperature. These ESR limitations make designing with LDOs more difficult because of their unclear specifications and extreme variations over temperature.

With the ADP3338 anyCAP LDO, this is no longer true. It can be used with virtually any good quality capacitor, with no constraint on the minimum ESR. This innovative design provides circuit stability with just a small 1 μ F capacitor on the output. Additional advantages of the pole-splitting scheme include superior line noise rejection and very high regulator gain to achieve excellent line and load regulation. An impressive $\pm 1.4\%$ accuracy is guaranteed over line, load, and temperature.

Additional features of the circuit include current limit and thermal shutdown.

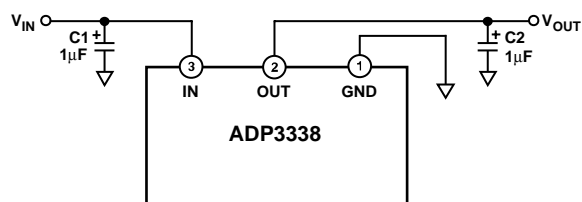

Figure 20. Typical Application Circuit

02050-021

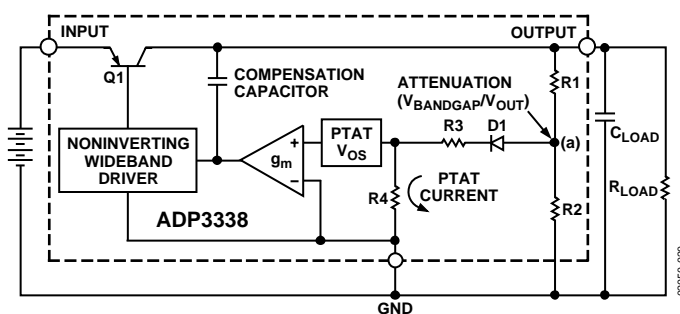

Figure 21. Functional Block Diagram

02050-020

APPLICATION INFORMATION

CAPACITOR SELECTION

Output Capacitor

The stability and transient response of the LDO is a function of the output capacitor. The ADP3338 is stable with a wide range of capacitor values, types, and ESR (anyCAP). A capacitor as low as 1 μF is the only requirement for stability. A higher capacitance may be necessary if high output current surges are anticipated, or if the output capacitor cannot be located near the output and ground pins. The ADP3338 is stable with extremely low ESR capacitors ($\text{ESR} \approx 0$) such as multilayer ceramic capacitors (MLCC) or OSCON. Note that the effective capacitance of some capacitor types falls below the minimum over temperature or with dc voltage.

Input Capacitor

An input bypass capacitor is not strictly required, but is recommended in any application involving long input wires or high source impedance. Connecting a 1 μF capacitor from the input to ground reduces the sensitivity of the circuit to PC board layout and input transients. If a larger output capacitor is necessary, a larger value input capacitor is recommended.

OUTPUT CURRENT LIMIT

The ADP3338 is short-circuit protected by limiting the pass transistor's base drive current. The maximum output current is limited to approximately 2 A (see Figure 16).

THERMAL OVERLOAD PROTECTION

The ADP3338 is protected against damage due to excessive power dissipation by its thermal overload protection circuit. Thermal protection limits the die temperature to a maximum of 160°C. Under extreme conditions, such as high ambient temperature and power dissipation where the die temperature starts to rise above 160°C, the output current is reduced until the die temperature has dropped to a safe level.

Current and thermal limit protections are intended to protect the device against accidental overload conditions. For normal operation, externally limit the power dissipation of the device so the junction temperature does not exceed 150°C.

CALCULATING POWER DISSIPATION

Device power dissipation is calculated as

$$P_D = (V_{IN} - V_{OUT}) \times I_{LOAD} + (V_{IN} \times I_{GND})$$

Where I_{LOAD} and I_{GND} are load current and ground current, and V_{IN} and V_{OUT} are the input and output voltages, respectively. Assuming the worst-case operating conditions are $I_{LOAD} = 1.0 \text{ A}$, $I_{GND} = 10 \text{ mA}$, $V_{IN} = 3.3 \text{ V}$, and $V_{OUT} = 2.5 \text{ V}$, the device power dissipation is

$$P_D = (3.3 \text{ V} - 2.5 \text{ V}) \times 1000 \text{ mA} + (3.3 \text{ V} \times 10 \text{ mA}) = 833 \text{ mW}$$

So, for a junction temperature of 125°C and a maximum ambient temperature of 85°C, the required thermal resistance from junction to ambient is

$$\theta_{JA} = \frac{125^\circ\text{C} - 85^\circ\text{C}}{0.833 \text{ W}} = 48^\circ\text{C/W}$$

PRINTED CIRCUIT BOARD LAYOUT CONSIDERATIONS

The thermal resistance, θ_{JA} , of the SOT-223 is determined by the sum of the junction-to-case and the case-to-ambient thermal resistances. The junction-to-case thermal resistance, θ_{JC} , is determined by the package design and is specified at 26.8°C/W. However, the case-to-ambient thermal resistance is determined by the printed circuit board design.

As shown in Figure 22, the amount of copper to which the ADP3338 is mounted affects thermal performance. When mounted to the minimal pads of 2 oz. copper, as shown in Figure 22 (a), θ_{JA} is 126.6°C/W. Adding a small copper pad under the ADP3338, as shown in Figure 22 (b), reduces the θ_{JA} to 102.9°C/W. Increasing the copper pad to one square inch, as shown in Figure 22 (c), reduces the θ_{JA} even further to 52.8°C/W.

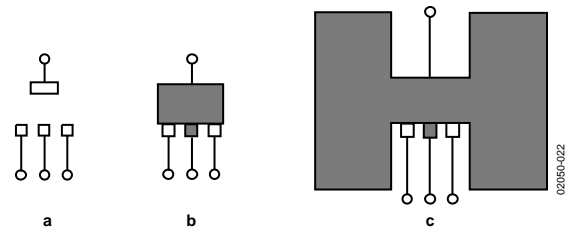
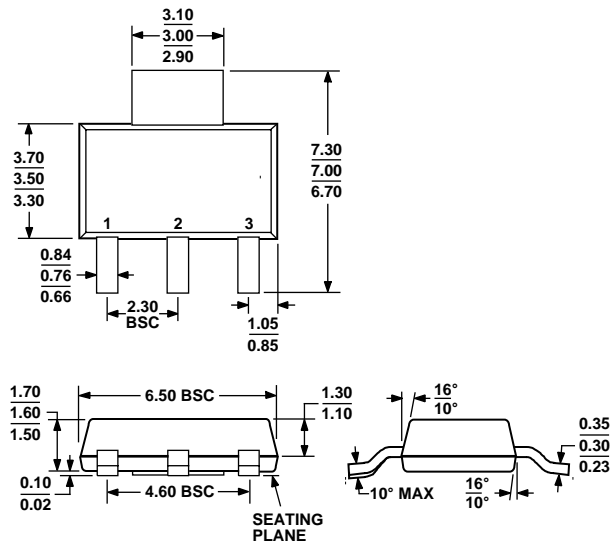

Figure 22. PCB Layouts

Use the following general guidelines when designing printed circuit boards:

- Keep the output capacitor as close as possible to the output and ground pins.
- Keep the input capacitor as close as possible to the input and ground pins.
- Specify thick copper and use wide traces for optimum heat transfer. PC board traces with larger cross sectional areas remove more heat from the ADP3338.
- Decrease thermal resistance by adding a copper pad under the ADP3338, as shown in Figure 22 (b).
- Use the adjacent area to the ADP3338 to add more copper around it. Connecting the copper area to the output of the ADP3338, as shown in Figure 22 (c), is best, but thermal performance will be improved even if it is connected to other signals.
- Use additional copper layers or planes to reduce the thermal resistance. Again, connecting the other layers to the output of the ADP3338 is best, but is not necessary. When connecting the output pad to other layers, use multiple vias.

OUTLINE DIMENSIONS



COMPLIANT TO JEDEC STANDARDS TO-261-AA

Figure 23. 3-Lead Small Outline Transistor Package [SOT-223] (KC-3)

Dimensions shown in millimeters

ORDERING GUIDE

Model	Temperature Range	Output Voltage (V)	Package Option	Package Description
ADP3338AKC-1.5-RL	-40°C to +85°C	1.5	KC-3	3-Lead SOT-223
ADP3338AKC-1.5-RL7	-40°C to +85°C	1.5	KC-3	3-Lead SOT-223
ADP3338AKCZ-1.5-RL ¹	-40°C to +85°C	1.5	KC-3	3-Lead SOT-223
ADP3338AKCZ-1.5-RL7 ¹	-40°C to +85°C	1.5	KC-3	3-Lead SOT-223
ADP3338AKC-1.8-RL	-40°C to +85°C	1.8	KC-3	3-Lead SOT-223
ADP3338AKC-1.8-RL7	-40°C to +85°C	1.8	KC-3	3-Lead SOT-223
ADP3338AKCZ-1.8-RL ¹	-40°C to +85°C	1.8	KC-3	3-Lead SOT-223
ADP3338AKCZ-1.8-R7 ¹	-40°C to +85°C	1.8	KC-3	3-Lead SOT-223
ADP3338AKC-2.5-RL	-40°C to +85°C	2.5	KC-3	3-Lead SOT-223
ADP3338AKC-2.5-RL7	-40°C to +85°C	2.5	KC-3	3-Lead SOT-223
ADP3338AKCZ-2.5-RL ¹	-40°C to +85°C	2.5	KC-3	3-Lead SOT-223
ADP3338AKCZ-2.5RL7 ¹	-40°C to +85°C	2.5	KC-3	3-Lead SOT-223
ADP3338AKC-2.85-RL	-40°C to +85°C	2.85	KC-3	3-Lead SOT-223
ADP3338AKC-2.85-RL7	-40°C to +85°C	2.85	KC-3	3-Lead SOT-223
ADP3338AKCZ-2.85R7 ¹	-40°C to +85°C	2.85	KC-3	3-Lead SOT-223
ADP3338AKC-3-RL	-40°C to +85°C	3.0	KC-3	3-Lead SOT-223
ADP3338AKC-3-RL7	-40°C to +85°C	3.0	KC-3	3-Lead SOT-223
ADP3338AKCZ-3-RL7 ¹	-40°C to +85°C	3.0	KC-3	3-Lead SOT-223
ADP3338AKC-3.3-RL	-40°C to +85°C	3.3	KC-3	3-Lead SOT-223
ADP3338AKC-3.3-RL7	-40°C to +85°C	3.3	KC-3	3-Lead SOT-223
ADP3338AKCZ-3.3-RL ¹	-40°C to +85°C	3.3	KC-3	3-Lead SOT-223
ADP3338AKCZ-3.3RL7 ¹	-40°C to +85°C	3.3	KC-3	3-Lead SOT-223
ADP3338AKC-5-REEL	-40°C to +85°C	5	KC-3	3-Lead SOT-223
ADP3338AKC-5-REEL7	-40°C to +85°C	5	KC-3	3-Lead SOT-223
ADP3338AKCZ-5-REEL ¹	-40°C to +85°C	5	KC-3	3-Lead SOT-223
ADP3338AKCZ-5-R7 ¹	-40°C to +85°C	5	KC-3	3-Lead SOT-223

¹ Z = Pb-free part.

ADP3338

NOTES

NOTES

ADP3338

NOTES