

FDPF6N60ZUT

N-Channel UniFET™ II Ultra FRFET™ MOSFET

600 V, 4.5 A, 2 Ω

Features

- $R_{DS(on)} = 1.7 \Omega$ (Typ.) @ $V_{GS} = 10 V, I_D = 2.25 A$
- Low Gate Charge (Typ. 14.5 nC)
- Low C_{rss} (Typ. 5 pF)
- 100% Avalanche Tested
- Improved dv/dt Capability
- RoHS Compliant

Applications

- LCD/LED TV
- Lighting
- Uninterruptible Power Supply
- AC-DC Power Supply

Description

UniFET™ II MOSFET is Fairchild Semiconductor's high voltage MOSFET family based on advanced planar stripe and DMOS technology. This advanced MOSFET family has the smallest on-state resistance among the planar MOSFET, and also provides superior switching performance and higher avalanche energy strength. In addition, internal gate-source ESD diode allows UniFET II MOSFET to withstand over 2kV HBM surge stress. UniFET II Ultra FRFET™ MOSFET has much superior body diode reverse recovery performance. Its t_{rr} is less than 50nsec and the reverse dv/dt immunity is 20V/nsec while normal planar MOSFETs have over 200nsec and 4.5V/nsec respectively. Therefore UniFET II Ultra FRFET MOSFET can remove additional component and improve system reliability in certain applications that require performance improvement of the MOSFET's body diode. This device family is suitable for switching power converter applications such as power factor correction (PFC), flat panel display (FPD) TV power, ATX and electronic lamp ballasts.

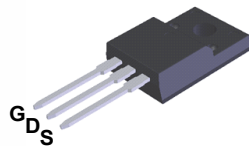

TO-220F

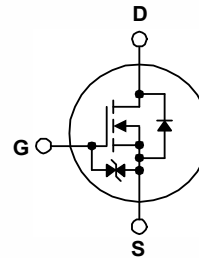

MOSFET Maximum Ratings $T_C = 25^\circ C$ unless otherwise noted.

Symbol	Parameter	FDPF6N60ZUT	Unit
V_{DSS}	Drain to Source Voltage	600	V
V_{GSS}	Gate to Source Voltage	±30	V
I_D	Drain Current	- Continuous ($T_C = 25^\circ C$)	4.5*
		- Continuous ($T_C = 100^\circ C$)	2.7*
I_{DM}	Drain Current	- Pulsed (Note 1)	18*
E_{AS}	Single Pulsed Avalanche Energy	(Note 2)	150
I_{AR}	Avalanche Current	(Note 1)	4.5
E_{AR}	Repetitive Avalanche Energy	(Note 1)	10.5
dv/dt	Peak Diode Recovery dv/dt	(Note 3)	20
P_D	Power Dissipation	($T_C = 25^\circ C$)	33.8
		- Derate Above $25^\circ C$	0.27
T_J, T_{STG}	Operating and Storage Temperature Range	-55 to +150	$^\circ C$
T_L	Maximum Lead Temperature for Soldering, 1/8" from Case for 5 Seconds	300	$^\circ C$

*Drain current limited by maximum junction temperature

Thermal Characteristics

Symbol	Parameter	FDPF6N60ZUT	Unit
$R_{\theta JC}$	Thermal Resistance, Junction to Case, Max.	3.7	$^\circ C/W$
$R_{\theta JA}$	Thermal Resistance, Junction to Ambient, Max.	62.5	

Package Marking and Ordering Information

Part Number	Top Mark	Package	Packing Method	Reel Size	Tape Width	Quantity
FDPF6N60ZUT	FDPF6N60ZUT	TO-220F	Tube	N/A	N/A	50 units

Electrical Characteristics $T_C = 25^\circ\text{C}$ unless otherwise noted.

Symbol	Parameter	Test Conditions	Min.	Typ.	Max.	Unit
--------	-----------	-----------------	------	------	------	------

Off Characteristics

BV_{DSS}	Drain to Source Breakdown Voltage	$I_D = 250 \mu\text{A}$, $V_{GS} = 0 \text{ V}$, $T_J = 25^\circ\text{C}$	600	-	-	V
$\Delta BV_{DSS} / \Delta T_J$	Breakdown Voltage Temperature Coefficient	$I_D = 250 \mu\text{A}$, Referenced to 25°C	-	0.75	-	$\text{V}/^\circ\text{C}$
I_{DSS}	Zero Gate Voltage Drain Current	$V_{DS} = 600 \text{ V}$, $V_{GS} = 0 \text{ V}$ $V_{DS} = 480 \text{ V}$, $T_C = 125^\circ\text{C}$	-	-	25 250	μA
I_{GSS}	Gate to Body Leakage Current	$V_{GS} = \pm 30 \text{ V}$, $V_{DS} = 0 \text{ V}$	-	-	± 10	μA

On Characteristics

$V_{GS(th)}$	Gate Threshold Voltage	$V_{GS} = V_{DS}$, $I_D = 250 \mu\text{A}$	3.0	-	5.0	V
$R_{DS(on)}$	Static Drain to Source On Resistance	$V_{GS} = 10 \text{ V}$, $I_D = 2.25 \text{ A}$	-	1.7	2.0	Ω
g_{FS}	Forward Transconductance	$V_{DS} = 40 \text{ V}$, $I_D = 2.25 \text{ A}$	-	3.5	-	S

Dynamic Characteristics

C_{iss}	Input Capacitance	$V_{DS} = 25 \text{ V}$, $V_{GS} = 0 \text{ V}$, $f = 1 \text{ MHz}$	-	650	865	pF
C_{oss}	Output Capacitance		-	75	100	pF
C_{rss}	Reverse Transfer Capacitance		-	5	10	pF
Q_g	Total Gate Charge at 10V	$V_{DS} = 480 \text{ V}$, $I_D = 4.5 \text{ A}$, $V_{GS} = 10 \text{ V}$	-	14.5	20	nC
Q_{gs}	Gate to Source Gate Charge	(Note 4)	-	4	-	nC
Q_{gd}	Gate to Drain "Miller" Charge		-	6	-	nC

Switching Characteristics

$t_{d(on)}$	Turn-On Delay Time	$V_{DD} = 300 \text{ V}$, $I_D = 4.5 \text{ A}$, $R_G = 25 \Omega$, $V_{GS} = 10 \text{ V}$	-	19	48	ns
t_r	Turn-On Rise Time		-	25	60	ns
$t_{d(off)}$	Turn-Off Delay Time		-	25	60	ns
t_f	Turn-Off Fall Time		(Note 4)	-	45	100

Drain-Source Diode Characteristics

I_S	Maximum Continuous Drain to Source Diode Forward Current	-	-	4.5	A	
I_{SM}	Maximum Pulsed Drain to Source Diode Forward Current	-	-	18	A	
V_{SD}	Drain to Source Diode Forward Voltage	$V_{GS} = 0 \text{ V}$, $I_{SD} = 4.5 \text{ A}$	-	-	1.6	V
t_{rr}	Reverse Recovery Time	$V_{GS} = 0 \text{ V}$, $I_{SD} = 4.5 \text{ A}$, $di_F/dt = 100 \text{ A}/\mu\text{s}$	-	36	-	ns
Q_{rr}	Reverse Recovery Charge		-	37	-	nC

Notes:

- 1: Repetitive rating; pulse-width limited by maximum junction temperature.
- 2: $L = 15 \text{ mH}$, $I_{AS} = 4.5 \text{ A}$, $V_{DD} = 50 \text{ V}$, $R_G = 25 \Omega$, starting $T_J = 25^\circ\text{C}$.
- 3: $I_{SD} \leq 4.5 \text{ A}$, $di/dt \leq 200 \text{ A}/\mu\text{s}$, $V_{DD} \leq BV_{DSS}$, starting $T_J = 25^\circ\text{C}$.
- 4: Essentially independent of operating temperature typical characteristics.

Typical Performance Characteristics

Figure 1. On-Region Characteristics

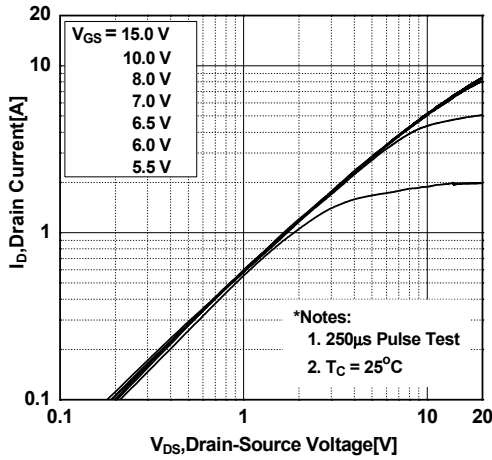

Figure 2. Transfer Characteristics

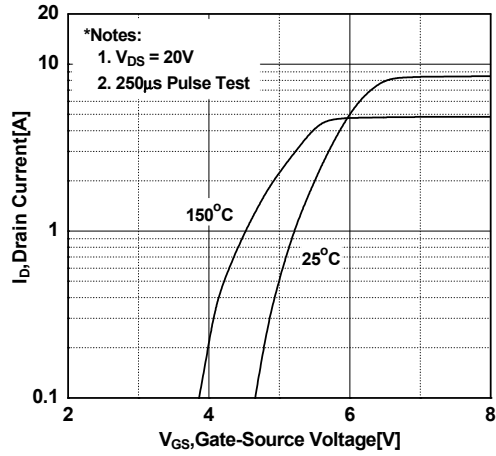

Figure 3. On-Resistance Variation vs. Drain Current and Gate Voltage

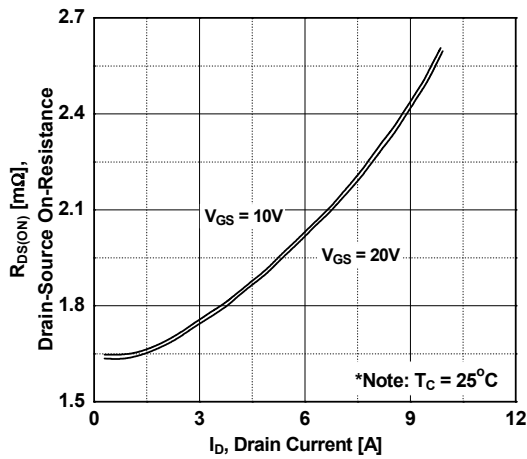

Figure 4. Body Diode Forward Voltage Variation vs. Source Current and Temperature

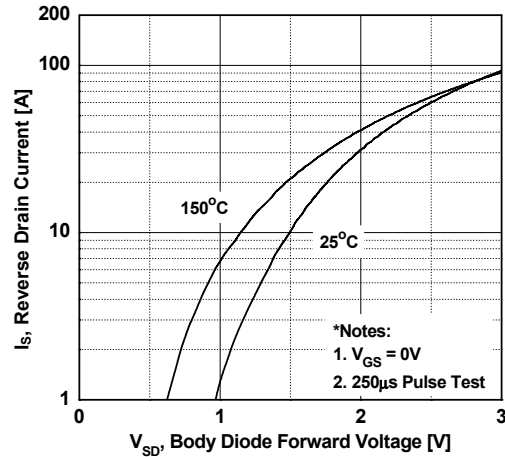

Figure 5. Capacitance Characteristics

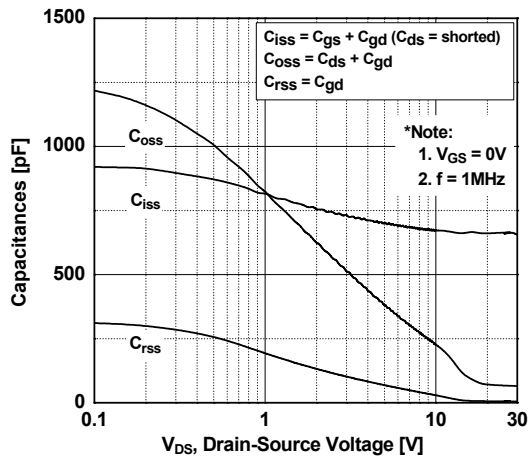
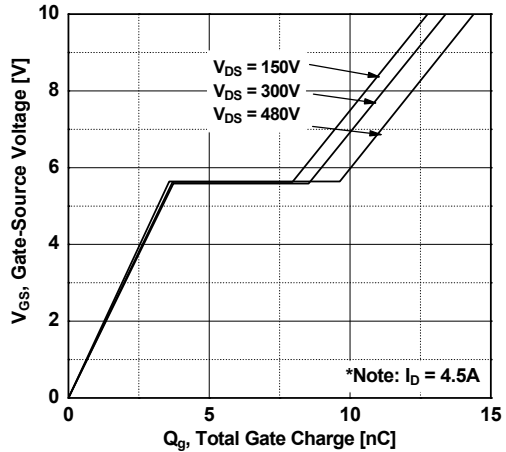

Figure 6. Gate Charge Characteristics



Typical Performance Characteristics (Continued)

Figure 7. Breakdown Voltage Variation vs. Temperature

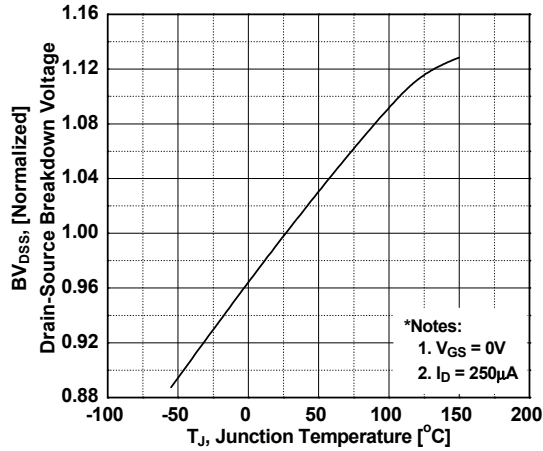

Figure 8. Maximum Safe Operating Area

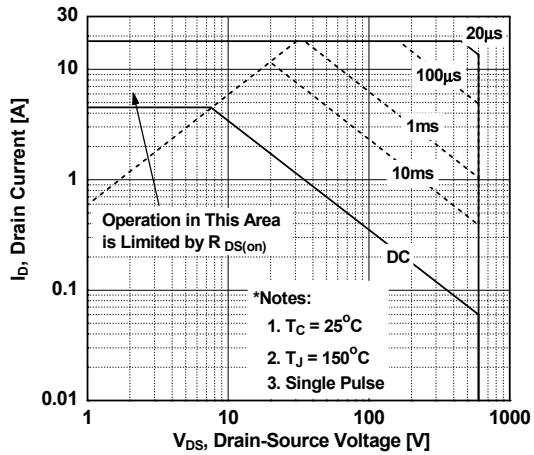

Figure 9. Maximum Drain Current vs. Case Temperature

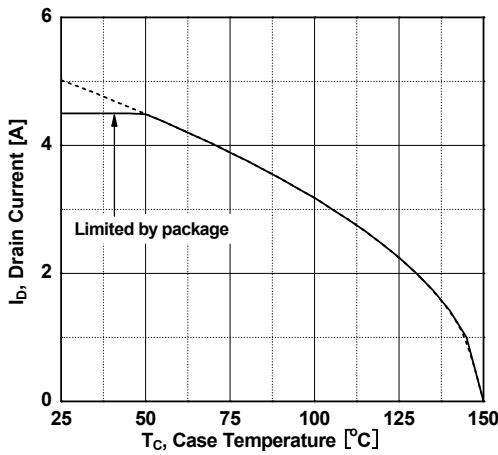
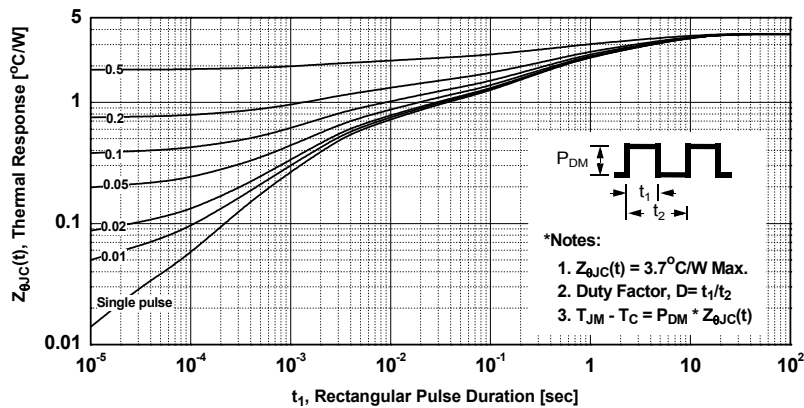

Figure 10. Transient Thermal Response Curve



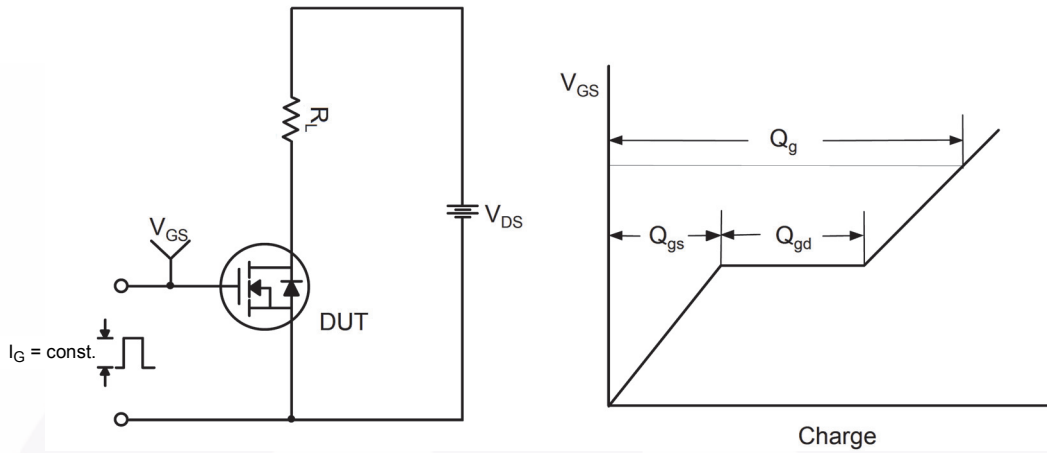

Figure 11. Gate Charge Test Circuit & Waveform



Figure 12. Resistive Switching Test Circuit & Waveforms

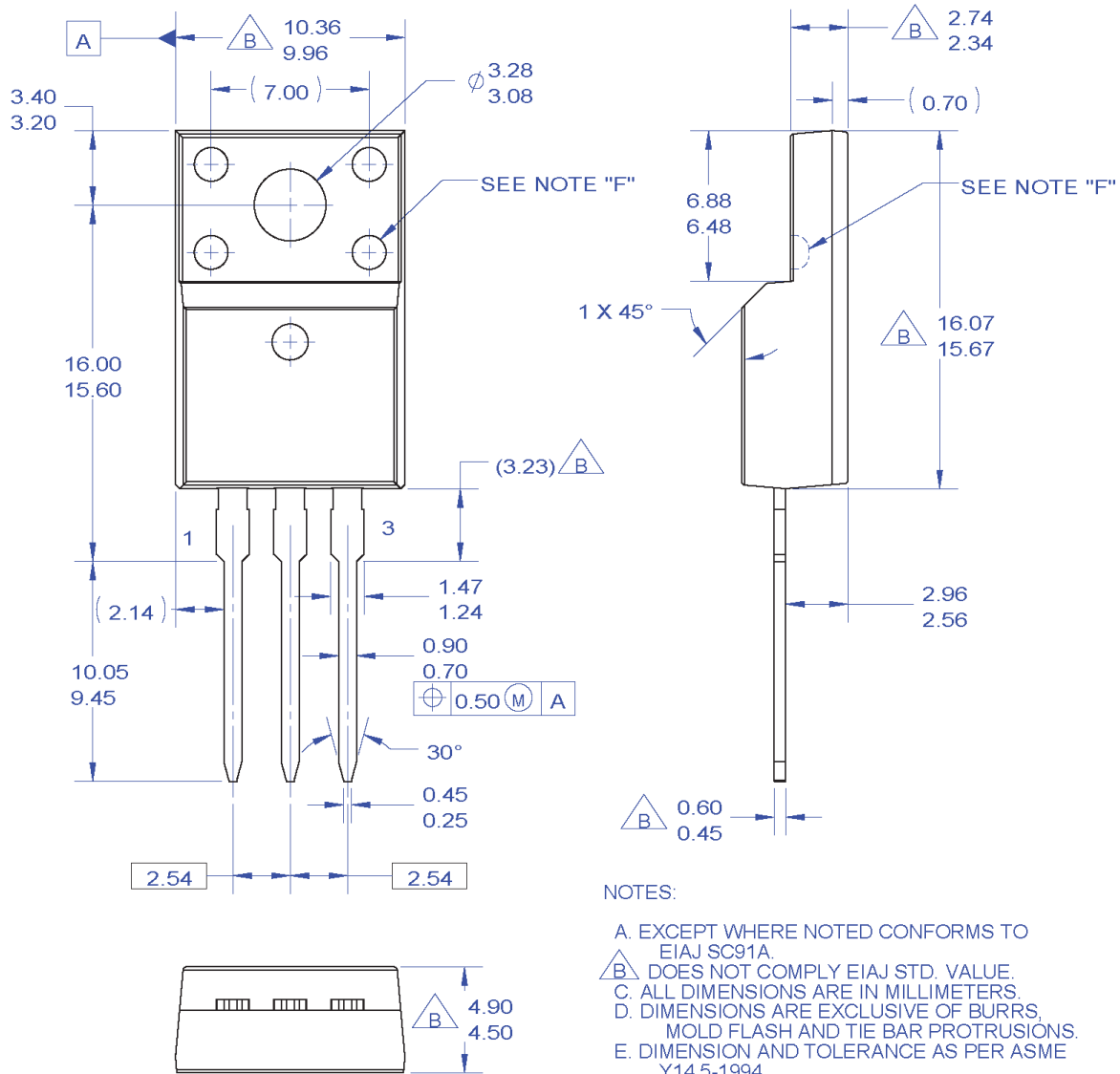

Figure 13. Unclamped Inductive Switching Test Circuit & Waveforms



Figure 14. Peak Diode Recovery dv/dt Test Circuit & Waveforms

Mechanical Dimensions



NOTES:

- A. EXCEPT WHERE NOTED CONFORMS TO EIAJ SC91A.
- B. DOES NOT COMPLY EIAJ STD. VALUE.
- C. ALL DIMENSIONS ARE IN MILLIMETERS.
- D. DIMENSIONS ARE EXCLUSIVE OF BURRS, MOLD FLASH AND TIE BAR PROTRUSIONS.
- E. DIMENSION AND TOLERANCE AS PER ASME Y14.5-1994.
- F. OPTION 1 - WITH SUPPORT PIN HOLE.
OPTION 2 - NO SUPPORT PIN HOLE.
- G. DRAWING FILE NAME: TO220M03REV3

Figure 15. TO220, Molded, 3-Lead, Full Pack, EIAJ SC91, Straight Lead

Package drawings are provided as a service to customers considering Fairchild components. Drawings may change in any manner without notice. Please note the revision and/or date on the drawing and contact a Fairchild Semiconductor representative to verify or obtain the most recent revision. Package specifications do not expand the terms of Fairchild's worldwide terms and conditions, specifically the warranty therein, which covers Fairchild products.





Always visit Fairchild Semiconductor's online packaging area for the most recent package drawings:

http://www.fairchildsemi.com/package/packageDetails.html?id=PN_TF220-003



TRADEMARKS

The following includes registered and unregistered trademarks and service marks, owned by Fairchild Semiconductor and/or its global subsidiaries, and is not intended to be an exhaustive list of all such trademarks.

- | | | |
|--|--|--|
| AccuPower™ | F-PFS™ | Sync-Lock™ |
| AX-CAP®* | FRFET® |  SYSTEM GENERAL®* |
| BitSiC™ | Global Power ResourceSM | TinyBoost® |
| Build it Now™ | GreenBridge™ | TinyBuck® |
| CorePLUS™ | Green FPS™ | TinyCalc™ |
| CorePOWER™ | Green FPS™ e-Series™ | TinyLogic® |
| CROSSVOLT™ | Gmax™ | TINYOPTO™ |
| CTL™ | GTO™ | TinyPower™ |
| Current Transfer Logic™ | IntelliMAX™ | TinyPWM™ |
| DEUXPEED® | ISOPLANAR™ | TinyWire™ |
| Dual Cool™ | Marking Small Speakers Sound Louder and Better™ | TranSiC™ |
| EcoSPARK® | MegaBuck™ | TriFault Detect™ |
| EfficientMax™ | MICROCOUPLER™ | TRUECURRENT®* |
| ESBC™ | MicroFET™ | µSerDes™ |
|  Fairchild® | MicroPak™ |  SerDes™ |
| Fairchild Semiconductor® | MicroPak2™ | UHC® |
| FACT Quiet Series™ | MillerDrive™ | Ultra FRFET™ |
| FACT® | MotionMax™ | UniFET™ |
| FAST® | mWSaver® | VCX™ |
| FastvCore™ | OptoHiT™ | VisualMax™ |
| FETBench™ | OPTOLOGIC® | VoltagePlus™ |
| FPS™ | OPTOPLANAR® | XS™ |
| | | |
| |  PowerTrench® | |
| | PowerXS™ | |
| | Programmable Active Droop™ | |
| | QFET® | |
| | QS™ | |
| | Quiet Series™ | |
| | RapidConfigure™ | |
| |  SignalWise™ | |
| | Saving our world, 1mW/W/kW at a time™ | |
| | SmartMax™ | |
| | SMART START™ | |
| | Solutions for Your Success™ | |
| | SPM® | |
| | STEALTH™ | |
| | SuperFET® | |
| | SuperSOT™-3 | |
| | SuperSOT™-6 | |
| | SuperSOT™-8 | |
| | SupreMOS® | |
| | SyncFET™ | |

*Trademarks of System General Corporation, used under license by Fairchild Semiconductor.

DISCLAIMER

FAIRCHILD SEMICONDUCTOR RESERVES THE RIGHT TO MAKE CHANGES WITHOUT FURTHER NOTICE TO ANY PRODUCTS HEREIN TO IMPROVE RELIABILITY, FUNCTION, OR DESIGN. FAIRCHILD DOES NOT ASSUME ANY LIABILITY ARISING OUT OF THE APPLICATION OR USE OF ANY PRODUCT OR CIRCUIT DESCRIBED HEREIN; NEITHER DOES IT CONVEY ANY LICENSE UNDER ITS PATENT RIGHTS, NOR THE RIGHTS OF OTHERS. THESE SPECIFICATIONS DO NOT EXPAND THE TERMS OF FAIRCHILD'S WORLDWIDE TERMS AND CONDITIONS, SPECIFICALLY THE WARRANTY THEREIN, WHICH COVERS THESE PRODUCTS.

LIFE SUPPORT POLICY

FAIRCHILD'S PRODUCTS ARE NOT AUTHORIZED FOR USE AS CRITICAL COMPONENTS IN LIFE SUPPORT DEVICES OR SYSTEMS WITHOUT THE EXPRESS WRITTEN APPROVAL OF FAIRCHILD SEMICONDUCTOR CORPORATION.

As used here in:

- Life support devices or systems are devices or systems which, (a) are intended for surgical implant into the body or (b) support or sustain life, and (c) whose failure to perform when properly used in accordance with instructions for use provided in the labeling, can be reasonably expected to result in a significant injury of the user.
- A critical component in any component of a life support, device, or system whose failure to perform can be reasonably expected to cause the failure of the life support device or system, or to affect its safety or effectiveness.

ANTI-COUNTERFEITING POLICY

Fairchild Semiconductor Corporation's Anti-Counterfeiting Policy. Fairchild's Anti-Counterfeiting Policy is also stated on our external website, www.Fairchildsemi.com, under Sales Support. Counterfeiting of semiconductor parts is a growing problem in the industry. All manufactures of semiconductor products are experiencing counterfeiting of their parts. Customers who inadvertently purchase counterfeit parts experience many problems such as loss of brand reputation, substandard performance, failed application, and increased cost of production and manufacturing delays. Fairchild is taking strong measures to protect ourselves and our customers from the proliferation of counterfeit parts. Fairchild strongly encourages customers to purchase Fairchild parts either directly from Fairchild or from Authorized Fairchild Distributors who are listed by country on our web page cited above. Products customers buy either from Fairchild directly or from Authorized Fairchild Distributors are genuine parts, have full traceability, meet Fairchild's quality standards for handling and storage and provide access to Fairchild's full range of up-to-date technical and product information. Fairchild and our Authorized Distributors will stand behind all warranties and will appropriately address and warranty issues that may arise. Fairchild will not provide any warranty coverage or other assistance for parts bought from Unauthorized Sources. Fairchild is committed to combat this global problem and encourage our customers to do their part in stopping this practice by buying direct or from authorized distributors.

PRODUCT STATUS DEFINITIONS

Definition of Terms

Datasheet Identification	Product Status	Definition
Advance Information	Formative / In Design	Datasheet contains the design specifications for product development. Specifications may change in any manner without notice.
Preliminary	First Production	Datasheet contains preliminary data; supplementary data will be published at a later date. Fairchild Semiconductor reserves the right to make changes at any time without notice to improve design.
No Identification Needed	Full Production	Datasheet contains final specifications. Fairchild Semiconductor reserves the right to make changes at any time without notice to improve the design.
Obsolete	Not In Production	Datasheet contains specifications on a product that is discontinued by Fairchild Semiconductor. The datasheet is for reference information only.

Rev. I66