

FEATURES

225 ps propagation delay through the switch
4.5 Ω switch connection between ports
Data rate 1.244 Gbps
2.5 V/3.3 V supply operation
Level translation
 3.3 V to 2.5 V
 2.5 V to 1.8 V
Small signal bandwidth 610 MHz
6-lead SC70 package

APPLICATIONS

3.3 V to 2.5 V voltage translation
2.5 V to 1.8 V voltage translation
Bus switching
Docking stations
Memory switching
Analog switch applications

GENERAL DESCRIPTION

The ADG3248 is a 2.5 V or 3.3 V, high performance 2:1 multiplexer/demultiplexer. It is designed on a low voltage CMOS process, which provides low power dissipation yet gives high switching speed and very low on resistance. The low on resistance allows the input to be connected to the output without additional propagation delay or generating additional ground bounce noise.

Each switch of the ADG3248 conducts equally well in both directions when on. The ADG3248 exhibits break-before-make switching action, preventing momentary shorting when switching channels.

The ADG3248 is available in a tiny 6-lead SC70 package.

FUNCTIONAL BLOCK DIAGRAM

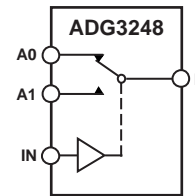

NOTES
 1. SWITCHES SHOWN FOR A LOGIC 0 INPUT

Figure 1.

04004-001

Table 1. ADG3248 Truth Table

IN Pin Logic Level	Function
Low (L)	B = A0
High (H)	B = A1

PRODUCT HIGHLIGHTS

1. 3.3 V or 2.5 V supply operation.
2. Extremely low propagation delay through switch.
3. 4.5 Ω switches connect inputs to outputs.
4. Tiny SC70 package.

Rev. A

Information furnished by Analog Devices is believed to be accurate and reliable. However, no responsibility is assumed by Analog Devices for its use, nor for any infringements of patents or other rights of third parties that may result from its use. Specifications subject to change without notice. No license is granted by implication or otherwise under any patent or patent rights of Analog Devices. Trademarks and registered trademarks are the property of their respective owners.

ADG3248* Product Page Quick Links

Last Content Update: 11/01/2016

[Comparable Parts](#)

View a parametric search of comparable parts

[Documentation](#)

Data Sheet

- ADG3248: 2.5 V/3.3 V, 2:1 Multiplexer/ Demultiplexer Bus Switch Data Sheet

[Reference Materials](#)

Product Selection Guide

- Switches and Multiplexers Product Selection Guide

Technical Articles

- CMOS Switches Offer High Performance in Low Power, Wideband Applications
- Data-acquisition system uses fault protection

[Design Resources](#)

- ADG3248 Material Declaration
- PCN-PDN Information
- Quality And Reliability
- Symbols and Footprints

[Discussions](#)

View all ADG3248 EngineerZone Discussions

[Sample and Buy](#)

Visit the product page to see pricing options

[Technical Support](#)

Submit a technical question or find your regional support number

TABLE OF CONTENTS

Features	1	Pin Configuration and Function Descriptions.....	5
Applications.....	1	Typical Performance Characteristics	6
General Description	1	Terminology	9
Functional Block Diagram	1	Bus Switch Applications	10
Product Highlights	1	Mixed Voltage Operation, Level Translation.....	10
Revision History	2	Analog Switching	10
Specifications.....	3	Multiplexing.....	11
Absolute Maximum Ratings.....	4	Outline Dimensions	12
ESD Caution.....	4	Ordering Guide	12

REVISION HISTORY

10/07—Rev. 0 to Rev. A

Updated Format.....	Universal
Changes to Table 1.....	1
Changes to Table 3,.....	4
Changes to Ordering Guide	12

10/03—Revision 0: Initial Version

SPECIFICATIONS

$V_{CC} = 2.3\text{ V to }3.6\text{ V}$, $GND = 0\text{ V}$, all specifications T_{MIN} to T_{MAX} , unless otherwise noted.¹

Table 2.

Parameter	Symbol	Conditions	B Version			Unit
			Min	Typ ²	Max	
DC ELECTRICAL CHARACTERISTICS						
Input High Voltage	V_{INH}	$V_{CC} = 2.7\text{ V to }3.6\text{ V}$	2.0			V
	V_{INH}	$V_{CC} = 2.3\text{ V to }2.7\text{ V}$	1.7			V
Input Low Voltage	V_{INL}	$V_{CC} = 2.7\text{ V to }3.6\text{ V}$			0.8	V
	V_{INL}	$V_{CC} = 2.3\text{ V to }2.7\text{ V}$			0.7	V
Input Leakage Current	I_i			± 0.01	± 1	μA
Off State Leakage Current	I_{OZ}	$0 \leq A, B \leq V_{CC}$		± 0.01	± 1	μA
On State Leakage Current	I_{OL}	$0 \leq A, B \leq V_{CC}$		± 0.01	± 1	μA
Maximum Pass Voltage	V_P	$V_A/V_B = V_{CC} = 3.3\text{ V}$, $I_O = -5\ \mu\text{A}$	2.0	2.5	2.9	V
		$V_A/V_B = V_{CC} = 2.5\text{ V}$, $I_O = -5\ \mu\text{A}$	1.5	1.8	2.1	V
CAPACITANCE³						
A Port Off Capacitance	C_A Off	$f = 1\text{ MHz}$		3.5		pF
B Port Off Capacitance	C_B Off	$f = 1\text{ MHz}$		4.5		pF
A, B Port On Capacitance	C_A, C_B On	$f = 1\text{ MHz}$		8.5		pF
Control Input Capacitance	C_{IN}	$f = 1\text{ MHz}$		4		pF
SWITCHING CHARACTERISTICS³						
Propagation Delay A to B or B to A, t_{PD} ⁴	t_{PHL}, t_{PLH}	$C_L = 50\text{ pF}$, $V_{CC} = 3\text{ V}$			0.225	ns
Propagation Delay Matching ⁵					5	ps
Transition Time	t_{TRANS}	$R_L = 510\ \Omega$, $C_L = 50\text{ pF}$		16	29	ns
Break-Before-Make Time	t_{BBM}	$R_L = 510\ \Omega$, $C_L = 50\text{ pF}$	5	10		ns
Maximum Data Rate		$V_{CC} = 3.3\text{ V}$; $V_A/V_B = 2\text{ V}$		1.244		Gbps
Channel Jitter		$V_{CC} = 3.3\text{ V}$; $V_A/V_B = 2\text{ V}$		45		ps p-p
DIGITAL SWITCH						
On Resistance	R_{ON}	$V_{CC} = 3\text{ V}$, $V_A = 0\text{ V}$, $I_{BA} = 8\text{ mA}$		4.5	8	Ω
		$V_{CC} = 3\text{ V}$, $V_A = 1.7\text{ V}$, $I_{BA} = 8\text{ mA}$		12	28	Ω
		$V_{CC} = 2.3\text{ V}$, $V_A = 0\text{ V}$, $I_{BA} = 8\text{ mA}$		5	9	Ω
		$V_{CC} = 2.3\text{ V}$, $V_A = 1\text{ V}$, $I_{BA} = 8\text{ mA}$		9	18	Ω
On-Resistance Matching	ΔR_{ON}	$V_{CC} = 3\text{ V}$, $V_A = 0\text{ V}$, $I_A = 8\text{ mA}$		0.1	0.5	Ω
POWER REQUIREMENTS						
V_{CC}			2.3		3.6	V
Quiescent Power Supply Current	I_{CC}	Digital inputs = 0 V or V_{CC}		0.01	1	μA

¹ Temperature range is as follows for B Version: -40°C to $+85^\circ\text{C}$.

² Typical values are at 25°C , unless otherwise stated.

³ Guaranteed by design, not subject to production test.

⁴ The digital switch contributes no propagation delay other than the resistance-capacitance (RC) delay of the typical R_{ON} of the switch and the load capacitance when driven by an ideal voltage source. Because the time constant is much smaller than the rise/fall times of typical driving signals, it adds very little propagation delay to the system. Propagation delay of the digital switch when used in a system is determined by the driving circuit on the driving side of the switch and its interaction with the load on the driven side.

⁵ Propagation delay matching between channels is calculated from the on-resistance matching and load capacitance of 50 pF .

ABSOLUTE MAXIMUM RATINGS

T_A = 25°C, unless otherwise noted.

Table 3.

Parameter	Rating
V _{CC} to GND	−0.5 V to +4.6 V
Digital Inputs to GND	−0.5 V to +4.6 V
DC Input Voltage	−0.5 V to +4.6 V
DC Output Current	25 mA per channel
Operating Temperature Range	
Industrial (B Version)	−40°C to +85°C
Storage Temperature Range	−65°C to +150°C
Junction Temperature	150°C
θ _{JA} Thermal Impedance	332°C/W
Lead Soldering	
Lead Temperature, Soldering (10 sec)	300°C
IR Reflow, Peak Temperature	220°C
Pb-Free Soldering	
Reflow, Peak Temperature	260(+0/−5)°C
Time at Peak Temperature	20 sec to 40 sec

Stresses above those listed under Absolute Maximum Ratings may cause permanent damage to the device. This is a stress rating only; functional operation of the device at these or any other conditions above those indicated in the operational section of this specification is not implied. Exposure to absolute maximum rating conditions for extended periods may affect device reliability.

ESD CAUTION



ESD (electrostatic discharge) sensitive device. Charged devices and circuit boards can discharge without detection. Although this product features patented or proprietary protection circuitry, damage may occur on devices subjected to high energy ESD. Therefore, proper ESD precautions should be taken to avoid performance degradation or loss of functionality.

PIN CONFIGURATION AND FUNCTION DESCRIPTIONS

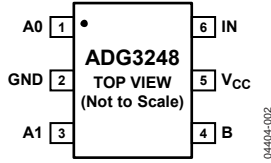

Figure 2. 6-Lead SC70

Table 4. Pin Function Descriptions

Pin No.	Mnemonic	Description
1	A0	Port A0, Input or Output.
2	GND	Ground Reference.
3	A1	Port A1, Input or Output.
4	B	Port B, Input or Output.
5	V _{CC}	Positive Power Supply Voltage.
6	IN	Channel Select.

TYPICAL PERFORMANCE CHARACTERISTICS

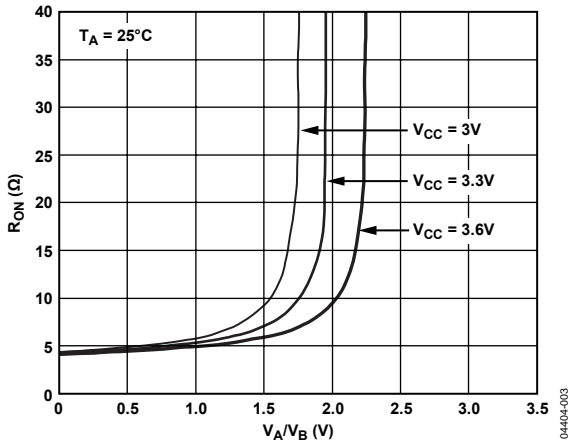

Figure 3. On Resistance vs. Input Voltage

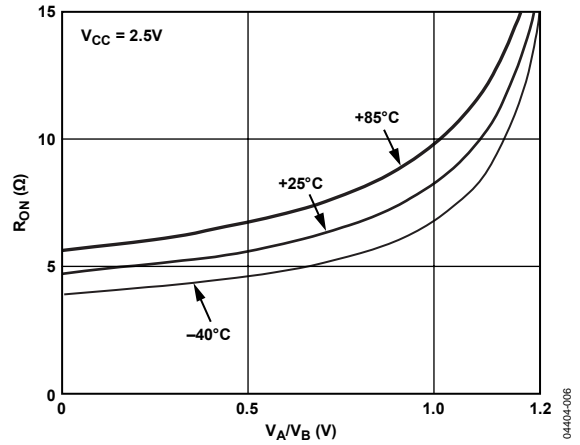

Figure 6. On Resistance vs. Input Voltage for Different Temperatures

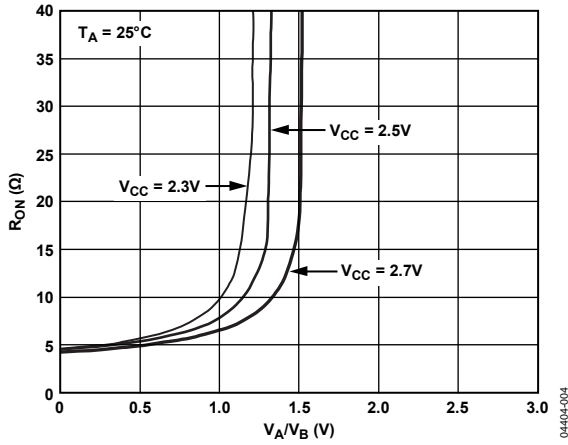

Figure 4. On Resistance vs. Input Voltage

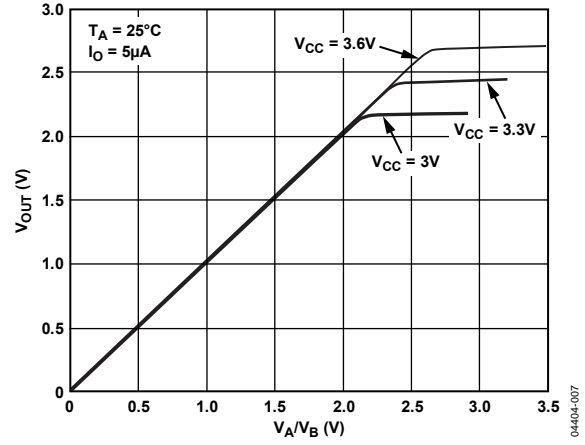

Figure 7. Pass Voltage vs. V_{CC}

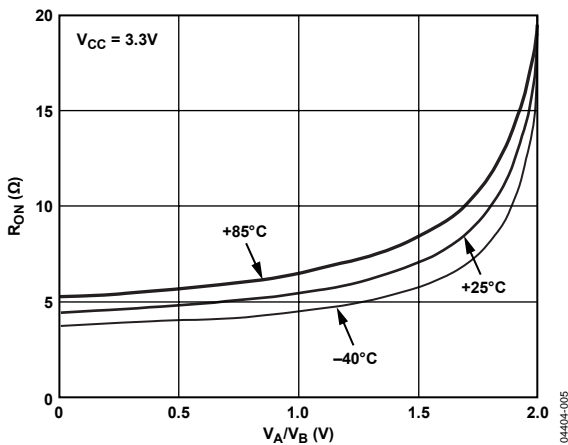

Figure 5. On Resistance vs. Input Voltage for Different Temperatures

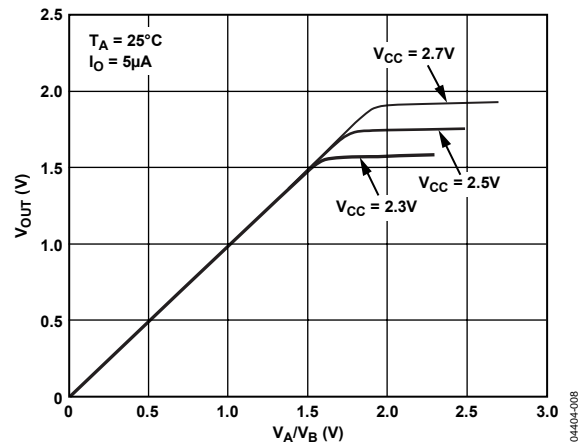

Figure 8. Pass Voltage vs. V_{CC}

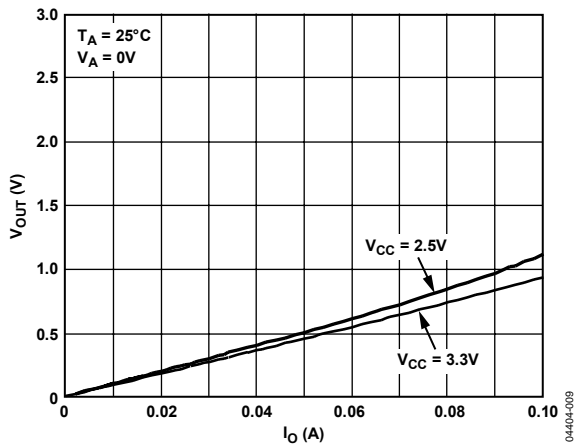

Figure 9. Output Low Characteristic

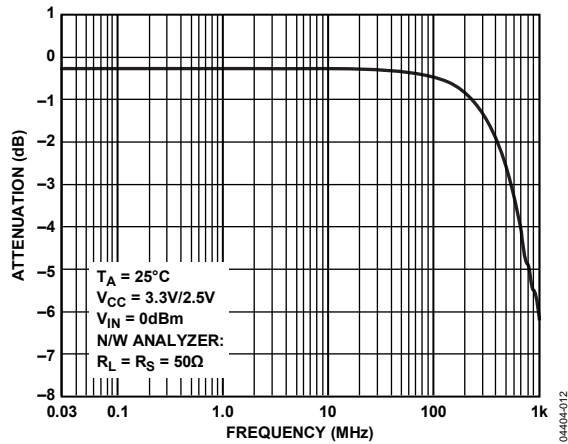

Figure 12. Bandwidth vs. Frequency

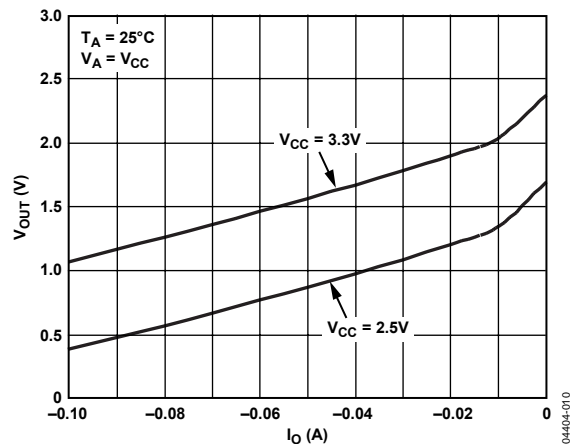

Figure 10. Output High Characteristic

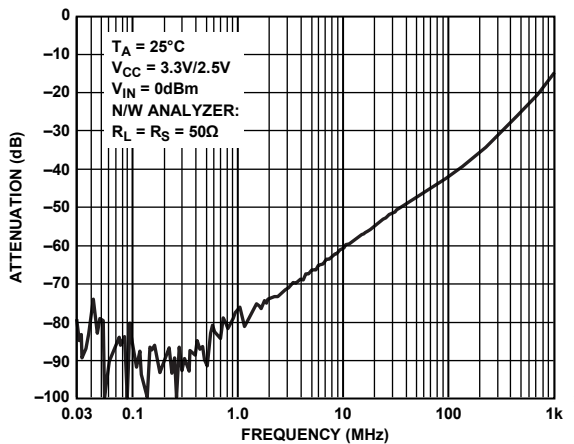

Figure 13. Crosstalk vs. Frequency

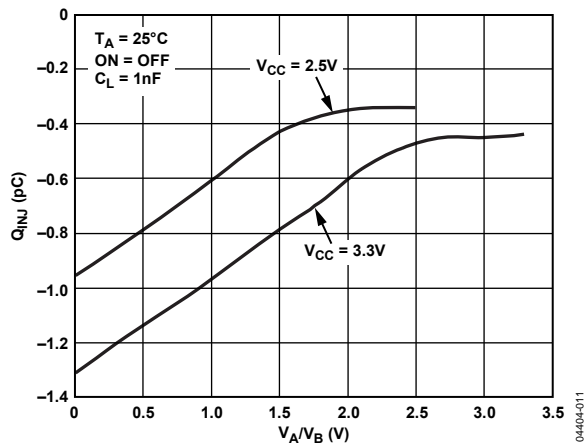

Figure 11. Charge Injection vs. Input Voltage

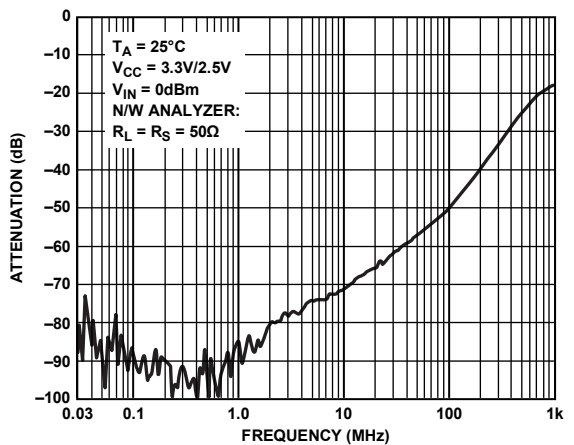

Figure 14. Off Isolation vs. Frequency

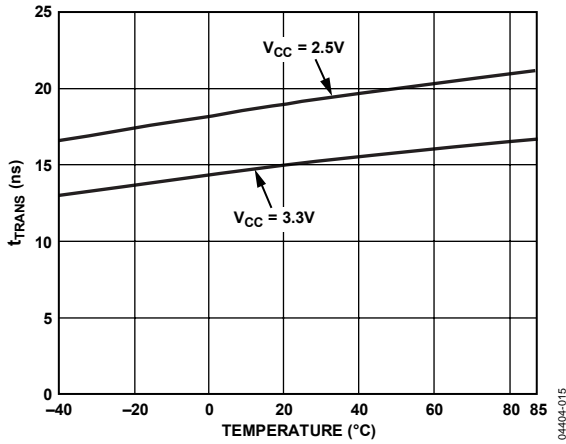

Figure 15. Transition Time vs. Temperature

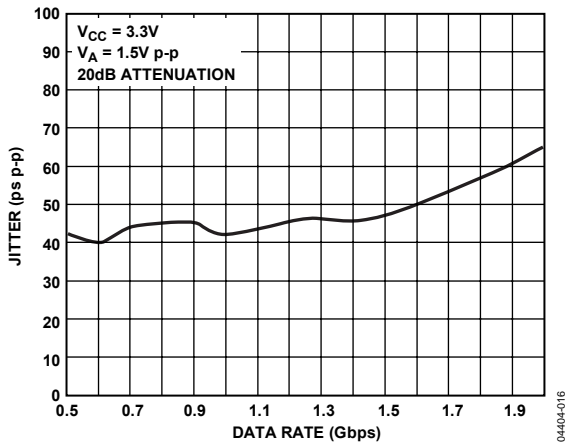

Figure 16. Jitter vs. Data Rate; PRBS 31

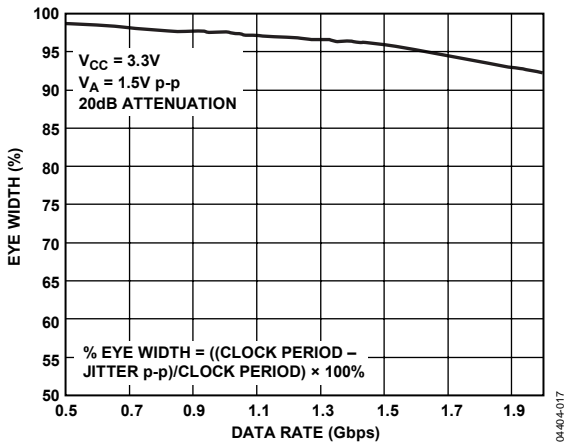

Figure 17. Eye Width vs. Data Rate; PRBS 31

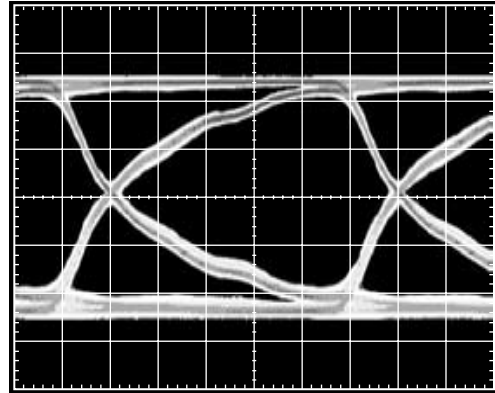

Figure 18. Eye Pattern; 1.244 Gbps, V_{CC} = 3.3 V, PRBS 31
 38.7mV/DIV V_{CC} = 3.3V 20dB ATTENUATION
 133.7ps/DIV V_{IN} = 2V p-p TA = 25°C

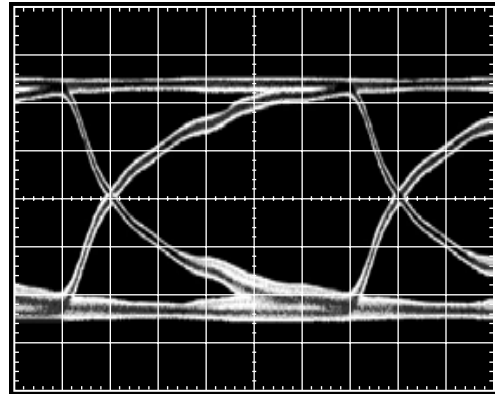

Figure 19. Eye Pattern; 1 Gbps, V_{CC} = 2.5 V, PRBS 31
 20mV/DIV V_{CC} = 2.5V 20dB ATTENUATION
 166.3ps/DIV V_{IN} = 1V p-p TA = 25°C

TERMINOLOGY

V_{CC}

Positive power supply voltage.

GND

Ground (0 V) reference.

V_{INH}

Minimum input voltage for Logic 1.

V_{INL}

Maximum input voltage for Logic 0.

I_I

Input leakage current at the control inputs.

I_{OZ}

Off state leakage current. I_{OZ} is the maximum leakage current at the switch pin in the off state.

I_{OL}

On state leakage current. I_{OL} is the maximum leakage current at the switch pin in the on state.

V_P

Maximum pass voltage. V_P relates to the clamped output voltage of an NMOS device when the switch input voltage is equal to the supply voltage.

R_{ON}

Ohmic resistance offered by a switch in the on state. R_{ON} is measured at a given voltage by forcing a specified amount of current through the switch.

ΔR_{ON}

On resistance match between any two channels, that is, R_{ON max} – R_{ON min}.

C_{X Off}

Off switch capacitance.

C_{X On}

On switch capacitance.

C_{IN}

Control input capacitance. C_{IN} consists of IN.

I_{CC}

Quiescent power supply current. I_{CC} represents the leakage current between the V_{CC} and ground pins and is measured when all control inputs are at a logic high or logic low level and the switches are off.

t_{PLH}, t_{PHL}

Data propagation delay through the switch in the on state. Propagation delay is related to the RC time constant R_{ON} × C_L, where C_L is the load capacitance.

t_{BBM}

On or off time measured between the 90% points of both switches when switching from one to another.

t_{TRANS}

Time taken to switch from one channel to the other, measured from 50% of the in signal to 90% of the out signal.

Maximum Data Rate

Maximum rate at which data can be passed through the switch.

Channel Jitter

Peak-to-peak value of the sum of the deterministic and random jitter of the switch channel.

BUS SWITCH APPLICATIONS

MIXED VOLTAGE OPERATION, LEVEL TRANSLATION

Bus switches can provide an ideal solution for interfacing between mixed voltage systems. The ADG3248 is suitable for applications in which voltage translation from 3.3 V technology to a lower voltage technology is needed. This device can translate from 2.5 V to 1.8 V or bidirectionally from 3.3 V directly to 2.5 V.

Figure 20 shows a block diagram of a typical application in which a user needs to interface between a 3.3 V ADC and a 2.5 V microprocessor. The microprocessor may not have 3.3 V tolerant inputs; therefore, placing the ADG3248 between the two devices allows the devices to communicate easily. The bus switch directly connects the two blocks, thus introducing minimal propagation delay, timing skew, or noise.

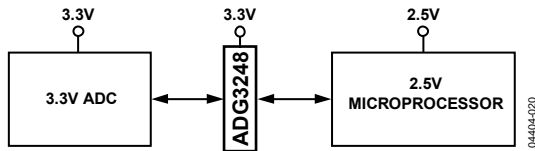

Figure 20. Level Translation Between a 3.3 V ADC and a 2.5 V Microprocessor

3.3 V to 2.5 V Translation

When V_{CC} is 3.3 V and the input signal range is 0 V to V_{CC} , the maximum output signal is clamped to within a voltage threshold below the V_{CC} supply.

In this case, the output is limited to 2.5 V, as shown in Figure 22. This device can be used for translation from 2.5 V to 3.3 V devices and also between two 3.3 V devices.

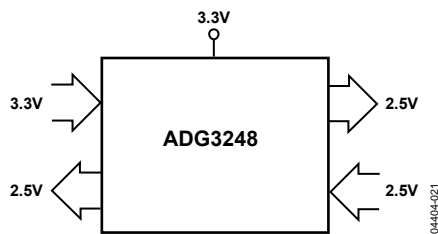

Figure 21. 3.3 V to 2.5 V Voltage Translation

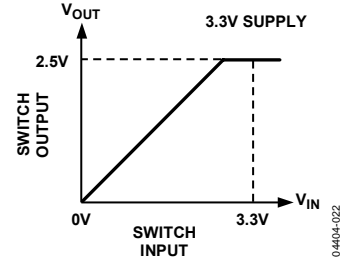

Figure 22. 3.3 V to 2.5 V Voltage Translation

2.5 V to 1.8 V Translation

When V_{CC} is 2.5 V and the input signal range is 0 V to V_{CC} , the maximum output signal is, as before, clamped to within a voltage threshold below the V_{CC} supply. In this case, the output is limited to approximately 1.8 V, as shown in Figure 24.

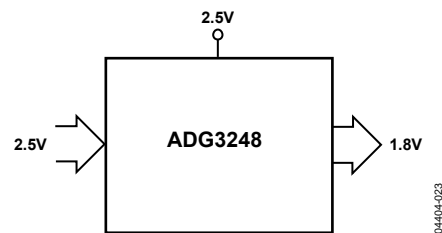

Figure 23. 2.5 V to 1.8 V Voltage Translation

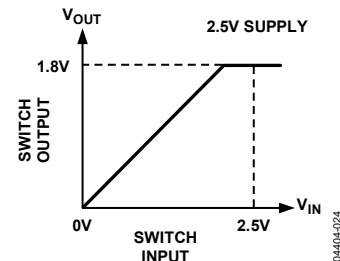

Figure 24. 2.5 V to 1.8 V Voltage Translation

ANALOG SWITCHING

Bus switches can be used in many analog switching applications, for example, video graphics. Bus switches can have lower on resistance, smaller on and off channel capacitance, and thus better frequency performance than their analog counterparts. The bus switch channel itself, consisting solely of an NMOS switch, limits the operating voltage (see Figure 3 for a typical plot) but, in many cases, this does not present an issue.

MULTIPLEXING

Many systems, such as docking stations and memory banks, have a large number of common bus signals. Common problems faced by designers of these systems include

- Large delays caused by capacitive loading of the bus
- Noise due to simultaneous switching of the address and data bus signals

Figure 25 shows an array of memory banks in which each address and data signal is loaded by the sum of the individual loads. If a bus switch is used as shown in Figure 26, the output load on the memory address and data bits is halved. The speed at which data from the selected bank can flow is much improved because the capacitance loading is halved and the switches introduce negligible propagation delay. Bus noise is also reduced.

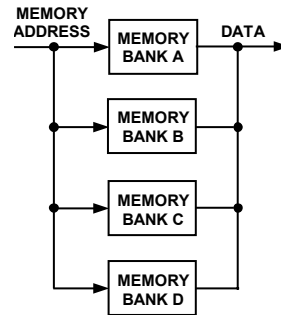

04404-025

Figure 25. All Memory Banks Are Permanently Connected to the Bus

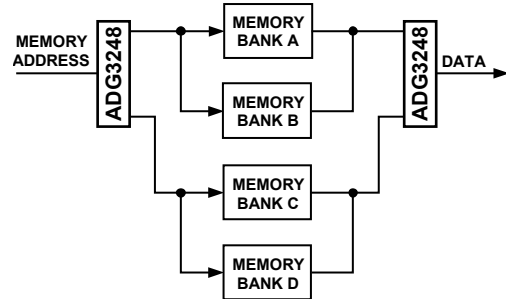

04404-026

Figure 26. ADG3248 Used to Reduce Both Access Time and Noise

OUTLINE DIMENSIONS

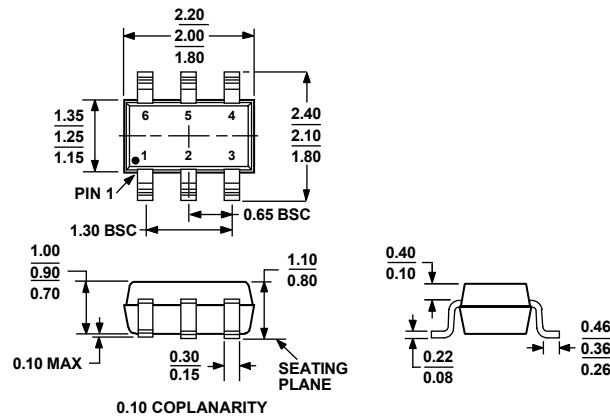

COMPLIANT TO JEDEC STANDARDS MO-203-AB

Figure 27. 6-Lead Thin Shrink Small Outline Transistor Package [SC70] (KS-6)

Dimensions shown in millimeters

ORDERING GUIDE

Model	Temperature Range	Package Description	Package Option	Branding
ADG3248BKS-R2	-40°C to +85°C	6-Lead Thin Shrink Small Outline Transistor Package (SC70)	KS-6	SMA
ADG3248BKS-REEL	-40°C to +85°C	6-Lead Thin Shrink Small Outline Transistor Package (SC70)	KS-6	SMA
ADG3248BKS-REEL7	-40°C to +85°C	6-Lead Thin Shrink Small Outline Transistor Package (SC70)	KS-6	SMA
ADG3248BKSZ-REEL7 ¹	-40°C to +85°C	6-Lead Thin Shrink Small Outline Transistor Package (SC70)	KS-6	S1W

¹ Z = RoHS Compliant Part.