

# TIL111M, TIL117M, MOC8100M General Purpose 6-Pin Phototransistor Optocouplers

## Features

- UL Recognized (File # E90700)
- VDE Recognized (File #102497 for white package)
  - Add Option V (e.g., TIL111VM)

## Applications

- Power Supply Regulators
- Digital Logic Inputs
- Microprocessor Inputs
- Appliance Sensor Systems
- Industrial Controls

## General Description

The MOC8100M, TIL111M, and TIL117M optocouplers consist of a gallium arsenide infrared emitting diode driving a silicon phototransistor in a 6-pin dual in-line package.

## Schematic

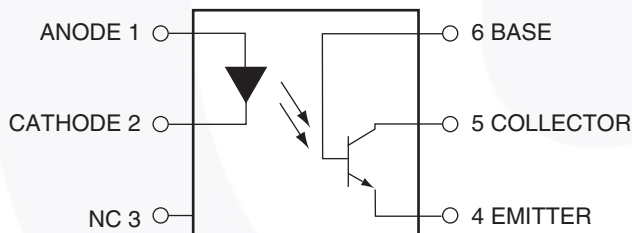

Figure 1. Schematic

## Package Outlines

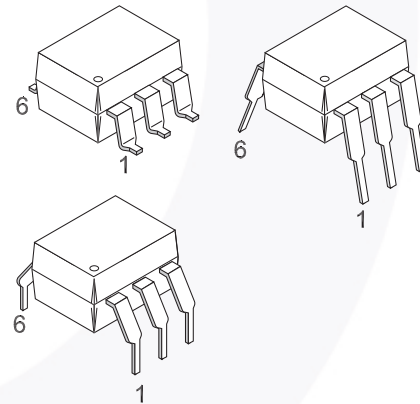

Figure 2. Package Outlines

## Safety and Insulation Ratings

As per IEC60747-5-2. This optocoupler is suitable for “safe electrical insulation” only within the safety limit data. Compliance with the safety ratings shall be ensured by means of protective circuits.

Symbol	Parameter	Min.	Typ.	Max.	Unit
	Installation Classifications per DIN VDE 0110/1.89 Table 1 For Rated Mains Voltage < 150 V <sub>RMS</sub>		I-IV		
	For Rated Mains Voltage < 300 V <sub>RMS</sub>		I-IV		
	Climatic Classification		55/100/21		
	Pollution Degree (DIN VDE 0110/1.89)		2		
CTI	Comparative Tracking Index	175			
V <sub>PR</sub>	Input to Output Test Voltage, Method b, V <sub>IORM</sub> × 1.875 = V <sub>PR</sub> , 100% Production Test with t <sub>m</sub> = 1 s, Partial Discharge < 5 pC	1594			
	Input to Output Test Voltage, Method a, V <sub>IORM</sub> × 1.5 = V <sub>PR</sub> , Type and Sample Test with t <sub>m</sub> = 60 s, Partial Discharge < 5 pC	1275			
V <sub>IORM</sub>	Maximum Working Insulation Voltage	850			V <sub>peak</sub>
V <sub>IOTM</sub>	Highest Allowable Over Voltage	6000			V <sub>peak</sub>
	External Creepage	7			mm
	External Clearance	7			mm
	Insulation Thickness	0.5			mm
R <sub>IO</sub>	Insulation Resistance at T <sub>S</sub> , V <sub>IO</sub> = 500 V	10 <sup>9</sup>			Ω

## Absolute Maximum Ratings

Stresses exceeding the absolute maximum ratings may damage the device. The device may not function or be operable above the recommended operating conditions and stressing the parts to these levels is not recommended. In addition, extended exposure to stresses above the recommended operating conditions may affect device reliability. The absolute maximum ratings are stress ratings only.

Symbol	Parameter	Device	Value	Units
<b>Total Device</b>				
T <sub>STG</sub>	Storage Temperature	All	-40 to +150	°C
T <sub>OPR</sub>	Operating Temperature	All	-40 to +100	°C
T <sub>SOL</sub>	Lead Solder Temperature	All	260 for 10 sec	°C
P <sub>D</sub>	Total Device Power Dissipation @ T <sub>A</sub> = 25°C Derate Above 25°C	All	250	mW
			2.94	mW/°C
<b>Emitter</b>				
I <sub>F</sub>	DC/Average Forward Input Current	All	60	mA
V <sub>R</sub>	Reverse Input Voltage	TIL111M	3	V
		MOC8100M, TIL117M	6	
I <sub>F(pk)</sub>	Forward Current – Peak (300 μs, 2% Duty Cycle)	All	3	A
P <sub>D</sub>	LED Power Dissipation @ T <sub>A</sub> = 25°C Derate Above 25°C	All	120	mW
			1.41	mW/°C
<b>Detector</b>				
V <sub>CEO</sub>	Collector-Emitter Voltage	All	30	V
V <sub>CBO</sub>	Collector-Base Voltage	All	70	V
V <sub>ECO</sub>	Emitter-Collector Voltage	TIL111M, TIL117M	7	V
V <sub>EBO</sub>	Emitter-Base Voltage	All	7	
P <sub>D</sub>	Detector Power Dissipation @ T <sub>A</sub> = 25°C Derate Above 25°C	All	150	mW
			1.76	mW/°C

## Electrical Characteristics

$T_A = 25^\circ\text{C}$  unless otherwise specified.

### Individual Component Characteristics

Symbol	Parameter	Test Conditions	Device	Min.	Typ.*	Max.	Unit	
<b>Emitter</b>								
$V_F$	Input Forward Voltage	$I_F = 16\text{ mA}$	$T_A = 25^\circ\text{C}$	TIL111M		1.2	1.4	V
		$I_F = 10\text{ mA}$ for MOC8100M, $I_F = 16\text{ mA}$ for TIL117M	$T_A = 0^\circ\text{C to } 70^\circ\text{C}$	MOC8100M, TIL117M		1.2	1.4	
			$T_A = -55^\circ\text{C}$			1.32		
			$T_A = +100^\circ\text{C}$			1.10		
$I_R$	Reverse Leakage Current	$V_R = 3.0\text{ V}$	TIL111M, TIL117M			0.001	10	$\mu\text{A}$
		$V_R = 6.0\text{ V}$	MOC8100M			0.001	10	$\mu\text{A}$
<b>Detector</b>								
$BV_{CEO}$	Collector-Emitter Breakdown Voltage	$I_C = 1.0\text{ mA}, I_F = 0$		All	30	100		V
$BV_{CBO}$	Collector-Base Breakdown Voltage	$I_C = 10\text{ }\mu\text{A}, I_F = 0$		All	70	120		V
$BV_{EBO}$	Emitter-Base Breakdown Voltage	$I_E = 10\text{ }\mu\text{A}, I_F = 0$		All	7	10		V
$BV_{ECO}$	Emitter-Collector Breakdown Voltage	$I_F = 100\text{ }\mu\text{A}, I_F = 0$		TIL111M, TIL117M	7	10		V
$I_{CEO}$	Collector-Emitter Dark Current	$V_{CE} = 10\text{ V}, I_F = 0$		TIL111M, TIL117M		1	50	nA
		$V_{CE} = 5\text{ V}, T_A = 25^\circ\text{C}$		MOC8100M		0.5	25	nA
		$V_{CE} = 30\text{ V}, I_F = 0, T_A = 70^\circ\text{C}$		TIL117M, MOC8100M		0.2	50	$\mu\text{A}$
$I_{CBO}$	Collector-Base Dark Current	$V_{CB} = 10\text{ V}$		TIL111M, TIL117M			20	nA
		$V_{CB} = 5\text{ V}$		MOC8100M			10	nA
$C_{CE}$	Capacitance	$V_{CE} = 0\text{ V}, f = 1\text{ MHz}$		All		8		pF

\*All Typical values at  $T_A = 25^\circ\text{C}$

**Electrical Characteristics** (Continued) $T_A = 25^\circ\text{C}$  unless otherwise specified.**Transfer Characteristics**

Symbol	Parameter	Test Conditions	Device	Min	Typ*	Max	Unit
<b>DC Characteristics</b>							
$CTR_{CE}$	Current Transfer Ratio, Collector to Emitter	$I_F = 10\text{ mA}, V_{CE} = 10\text{ V}$	TIL117M	50			%
		$I_F = 1\text{ mA}, V_{CE} = 5\text{ V}$	MOC8100M	50			%
		$I_F = 1\text{ mA}, V_{CE} = 5\text{ V}, T_A = 0^\circ\text{C to } +70^\circ\text{C}$		30			
$I_{C(ON)}$	On-State Collector Current (Phototransistor Operation)	$I_F = 16\text{ mA}, V_{CE} = 0.4\text{ V}$	TIL111M	2			mA
	On-State Collector Current (Photodiode Operation)	$I_F = 16\text{ mA}, V_{CB} = 0.4\text{ V}$		7			$\mu\text{A}$
$V_{CE(SAT)}$	Collector-Emitter Saturation Voltage	$I_C = 500\text{ }\mu\text{A}, I_F = 10\text{ mA}$	TIL117M			0.4	V
		$I_C = 2\text{ mA}, I_F = 16\text{ mA}$	TIL111M			0.4	
		$I_C = 100\text{ }\mu\text{A}, I_F = 1\text{ mA}$	MOC8100M			0.5	
<b>AC Characteristics</b>							
$c_{ON}$	Turn-On Time	$I_C = 2\text{ mA}, V_{CC} = 10\text{ V}, R_L = 100\text{ }\Omega$ (Fig. 13)	MOC8100M			20	$\mu\text{s}$
			TIL117M			10	
$c_{OFF}$	Turn-Off Time		MOC8100M			20	$\mu\text{s}$
			TIL117M			10	
$t_r$	Rise Time		MOC8100M		2		$\mu\text{s}$
$t_f$	Fall Time		TIL117M		2		
$t_r$	Rise Time (Phototransistor Operation)	$I_{C(ON)} = 2\text{ mA}, V_{CC} = 10\text{ V}, R_L = 100\text{ }\Omega$ (Fig. 13)	TIL111M			10	$\mu\text{s}$
$t_f$	Fall Time (Phototransistor Operation)						

**Isolation Characteristics**

Symbol	Characteristic	Test Conditions	Min.	Typ.*	Max.	Units
$V_{ISO}$	Input-Output Isolation Voltage	$f = 60\text{ Hz}, t = 1\text{ s}$	7500			$V_{AC(PK)}$
$R_{ISO}$	Isolation Resistance	$V_{I-O} = 500\text{ V}_{DC}$	$10^{11}$			$\Omega$
$C_{ISO}$	Isolation Capacitance	$V_{I-O} = 0, f = 1\text{ MHz}$		0.2		pF

\*All Typical values at  $T_A = 25^\circ\text{C}$ .

## Typical Performance Characteristics

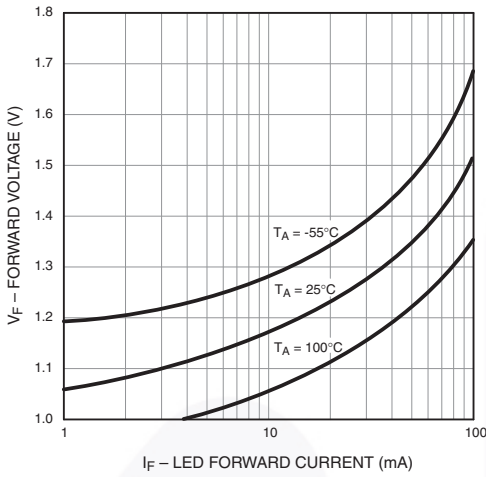

Figure 3. LED Forward Voltage vs. Forward Current

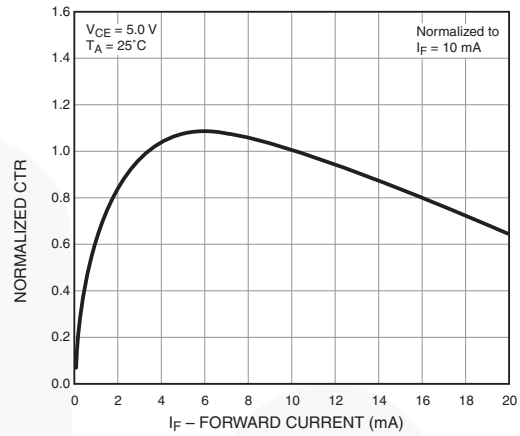

Figure 4. Normalized CTR vs. Forward Current

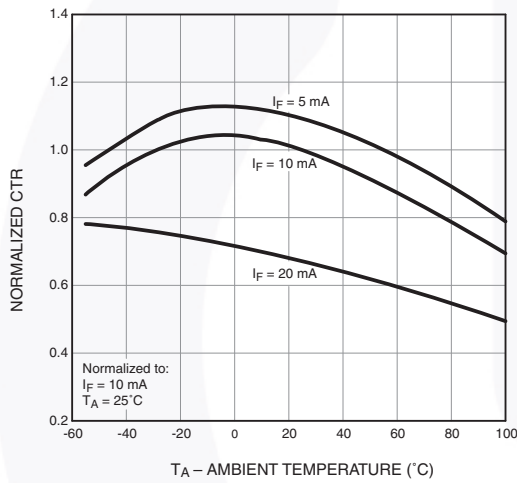

Figure 5. Normalized CTR vs. Ambient Temperature

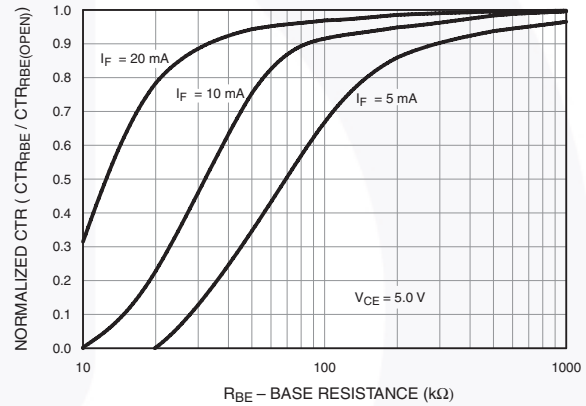

Figure 6. CTR vs. RBE (Unsaturated)

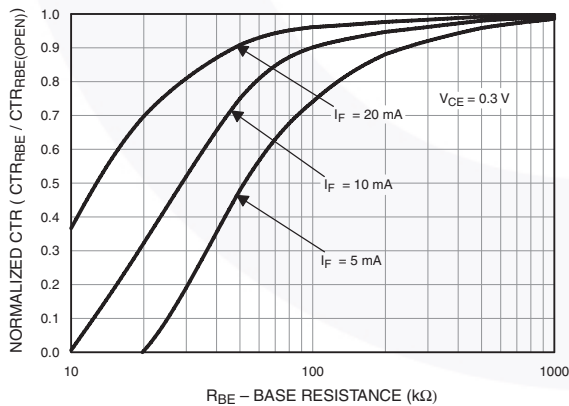

Figure 7. CTR vs. RBE (Saturated)

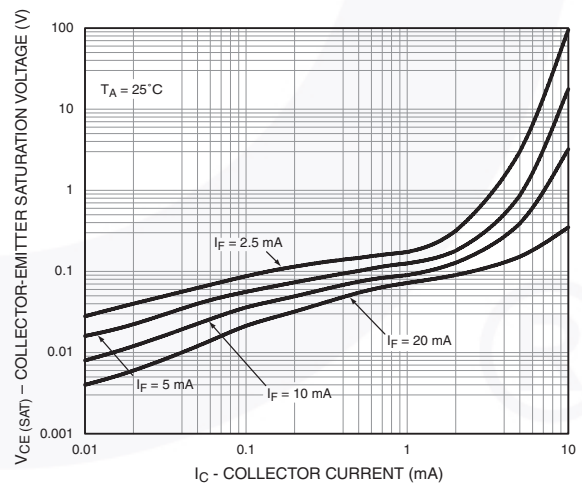

Figure 8. Collector-Emitter Saturation Voltage vs. Collector Current

Typical Performance Characteristics (Continued)

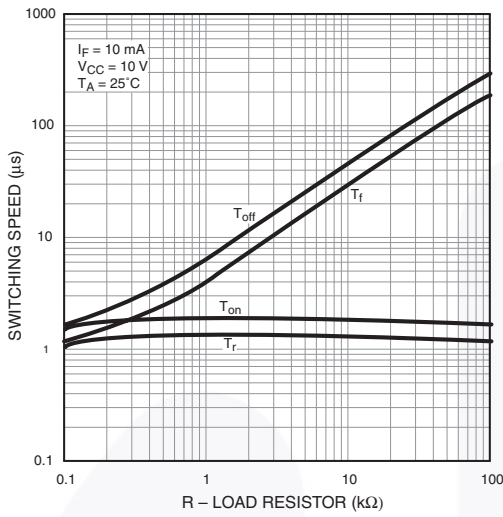

Figure 9. Switching Speed vs. Load Resistor

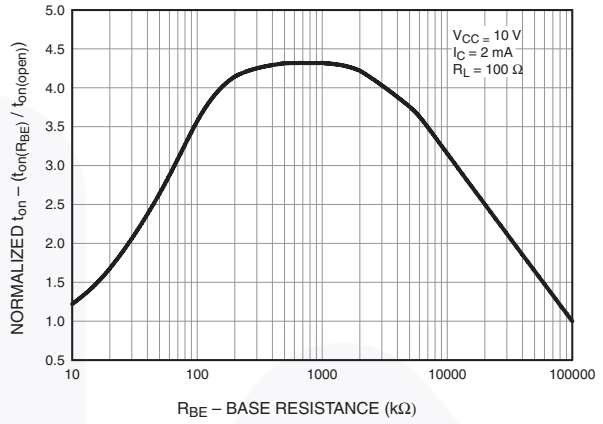

Figure 10. Normalized  $t_{on}$  vs.  $R_{BE}$

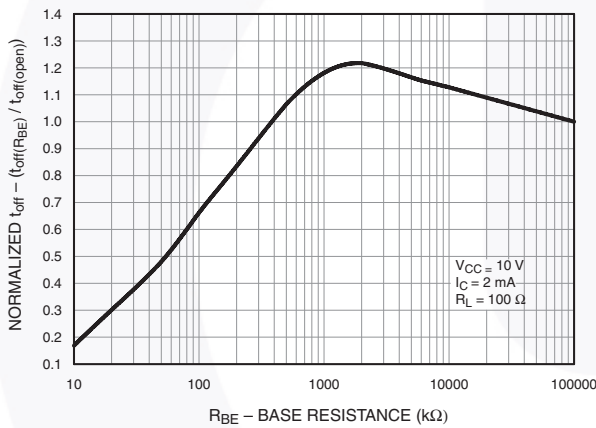

Figure 11. Normalized  $t_{off}$  vs.  $R_{BE}$

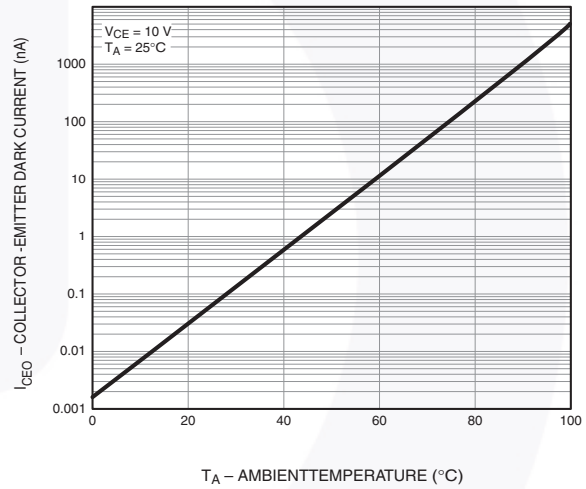

Figure 12. Dark Current vs. Ambient Temperature

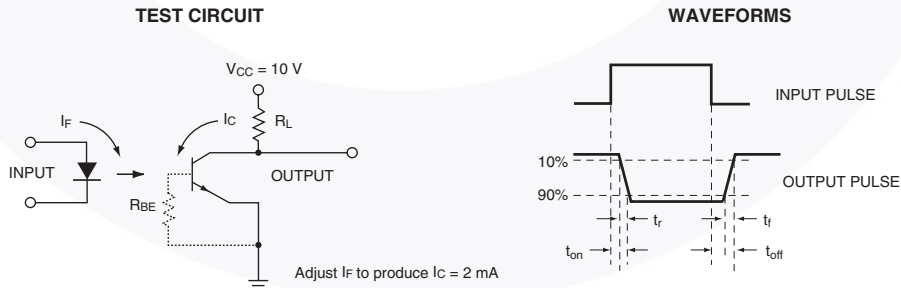

Figure 13. Switching Time Test Circuit and Waveforms

### Reflow Profile

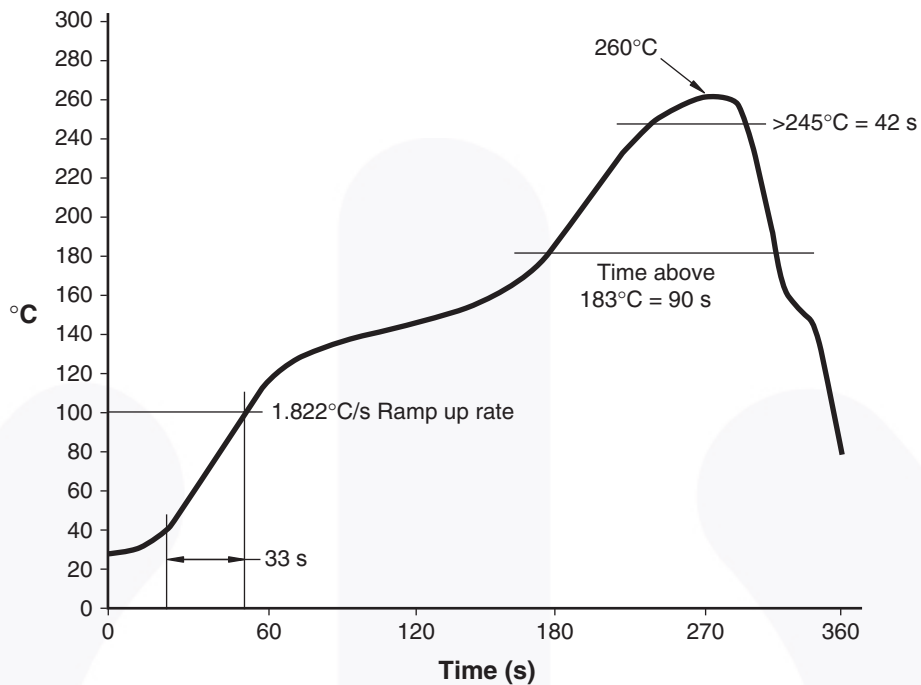

Figure 14. Reflow Profile



## Ordering Information

Option	Order Entry Identifier (Example)	Description
No option	TIL111M	Standard Through-Hole Device
S	TIL111SM	Surface Mount Lead Bend
SR2	TIL111SR2M	Surface Mount; Tape and Reel
T	TIL111TM	0.4" Lead Spacing
V	TIL111VM	VDE 0884
TV	TIL111TVM	VDE 0884, 0.4" Lead Spacing
SV	TIL111SVM	VDE 0884, Surface Mount
SR2V	TIL111SR2VM	VDE 0884, Surface Mount, Tape and Reel

## Marking Information

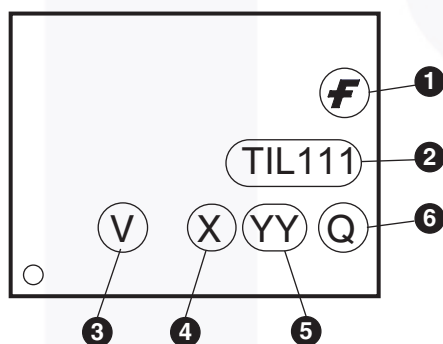

Definitions	
1	Fairchild logo
2	Device number
3	VDE mark (Note: Only appears on parts ordered with VDE option – See order entry table)
4	One-digit year code, e.g., '3'
5	Two-digit work week ranging from '01' to '53'
6	Assembly package code

\*Note – Parts that do not have the 'V' option (see definition 3 above) that are marked with date code '325' or earlier are marked in portrait format.

### Carrier Tape Specification

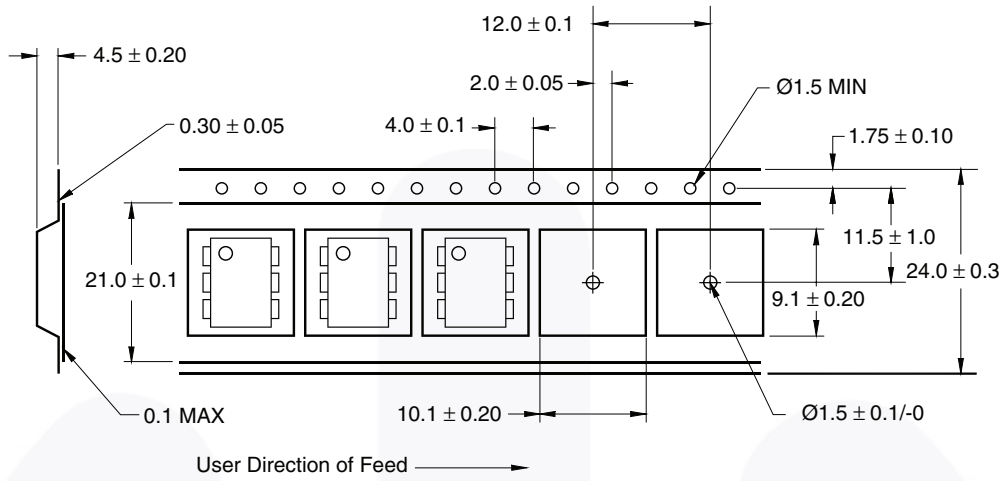
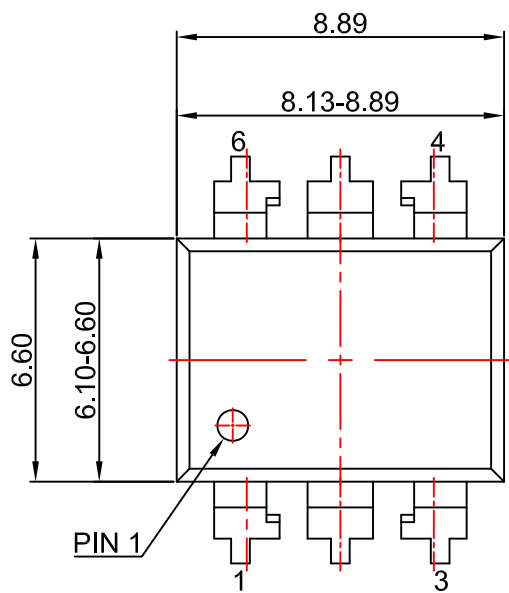

Figure 15. Carrier Tape Specification



NOTES:

- A) NO STANDARD APPLIES TO THIS PACKAGE.
- B) ALL DIMENSIONS ARE IN MILLIMETERS.
- C) DIMENSIONS ARE EXCLUSIVE OF BURRS, MOLD FLASH, AND TIE BAR EXTRUSION
- D) DRAWING FILENAME AND REVISION: MKT-N06BREV4.





LAND PATTERN RECOMMENDATION



NOTES:

- A) NO STANDARD APPLIES TO THIS PACKAGE.
- B) ALL DIMENSIONS ARE IN MILLIMETERS.
- C) DIMENSIONS ARE EXCLUSIVE OF BURRS, MOLD FLASH, AND TIE BAR EXTRUSION
- D) DRAWING FILENAME AND REVISION : MKT-N06CREV4.





**TRADEMARKS**

The following includes registered and unregistered trademarks and service marks, owned by Fairchild Semiconductor and/or its global subsidiaries, and is not intended to be an exhaustive list of all such trademarks.

- |                          |  |                                       |                  |
|--------------------------|--|---------------------------------------|------------------|
| AccuPower™               | F-PFS™   | OPTOPLANAR®                           | SYSTEM GENERAL®  |
| AttitudeEngine™          | FRFET®   | Power Supply WebDesigner™             | TinyBoost®       |
| Awinda®                  | Global Power Resource <sup>SM</sup>            | PowerTrench®                          | TinyBuck®        |
| AX-CAP®*                 | GreenBridge™                                   | PowerXS™                              | TinyCalc™        |
| BitSiC™                  | Green FPS™                                     | Programmable Active Droop™            | TinyLogic®       |
| Build it Now™            | Green FPS™ e-Series™                           | QFET®                                 | TINYOPTO™        |
| CorePLUS™                | Gmax™  | QS™                                   | TinyPower™       |
| CorePOWER™               | GTO™   | Quiet Series™                         | TinyPWM™         |
| CROSSVOL™                | IntelliMAX™                                    | RapidConfigure™                       | TinyWire™        |
| CTL™                     | ISOPLANAR™                                     | Saving our world, 1mW/W/kW at a time™ | TranSiC™         |
| Current Transfer Logic™  | Making Small Speakers Sound Louder and Better™ | SignalWise™                           | TriFault Detect™ |
| DEUXPEED®                | MegaBuck™                                      | SmartMax™                             | TRUECURRENT®*    |
| Dual Cool™               | MICROCOUPLER™                                  | SMART START™                          | μSerDes™         |
| EcoSPARK®                | MicroFET™                                      | Solutions for Your Success™           | UHC®             |
| EfficientMax™            | MicroPak™                                      | SPM®                                  | Ultra FRFET™     |
| ESBC™                    | MicroPak2™                                     | STEALTH™                              | UniFET™          |
| <b>F</b> ®               | MillerDrive™                                   | SuperFET®                             | Vcx™             |
| Fairchild®               | MotionMax™                                     | SuperSOT™-3                           | VisualMax™       |
| Fairchild Semiconductor® | MotionGrid®                                    | SuperSOT™-6                           | VoltagePlus™     |
| FACT Quiet Series™       | MTi®   | SuperSOT™-8                           | Xs™              |
| FACT®                    | MTx®   | SupreMOS®                             | Xsens™           |
| FastvCore™               | MVN®   | SyncFET™                              | 仙童®              |
| FETBench™                | mWSaver®                                       | Sync-Lock™                            |                  |
| FPS™                     | OptoHiT™                                       |                                       |                  |
|                          | OPTOLOGIC®                                     |                                       |                  |

\* Trademarks of System General Corporation, used under license by Fairchild Semiconductor.

**DISCLAIMER**

FAIRCHILD SEMICONDUCTOR RESERVES THE RIGHT TO MAKE CHANGES WITHOUT FURTHER NOTICE TO ANY PRODUCTS HEREIN TO IMPROVE RELIABILITY, FUNCTION, OR DESIGN. TO OBTAIN THE LATEST, MOST UP-TO-DATE DATASHEET AND PRODUCT INFORMATION, VISIT OUR WEBSITE AT [HTTP://WWW.FAIRCHILDSEMI.COM](http://www.fairchildsemi.com). FAIRCHILD DOES NOT ASSUME ANY LIABILITY ARISING OUT OF THE APPLICATION OR USE OF ANY PRODUCT OR CIRCUIT DESCRIBED HEREIN; NEITHER DOES IT CONVEY ANY LICENSE UNDER ITS PATENT RIGHTS, NOR THE RIGHTS OF OTHERS. THESE SPECIFICATIONS DO NOT EXPAND THE TERMS OF FAIRCHILD'S WORLDWIDE TERMS AND CONDITIONS, SPECIFICALLY THE WARRANTY THEREIN, WHICH COVERS THESE PRODUCTS.

**AUTHORIZED USE**

Unless otherwise specified in this data sheet, this product is a standard commercial product and is not intended for use in applications that require extraordinary levels of quality and reliability. This product may not be used in the following applications, unless specifically approved in writing by a Fairchild officer: (1) automotive or other transportation, (2) military/aerospace, (3) any safety critical application – including life critical medical equipment – where the failure of the Fairchild product reasonably would be expected to result in personal injury, death or property damage. Customer's use of this product is subject to agreement of this Authorized Use policy. In the event of an unauthorized use of Fairchild's product, Fairchild accepts no liability in the event of product failure. In other respects, this product shall be subject to Fairchild's Worldwide Terms and Conditions of Sale, unless a separate agreement has been signed by both Parties.

**ANTI-COUNTERFEITING POLICY**

Fairchild Semiconductor Corporation's Anti-Counterfeiting Policy. Fairchild's Anti-Counterfeiting Policy is also stated on our external website, [www.fairchildsemi.com](http://www.fairchildsemi.com), under Terms of Use

Counterfeiting of semiconductor parts is a growing problem in the industry. All manufacturers of semiconductor products are experiencing counterfeiting of their parts. Customers who inadvertently purchase counterfeit parts experience many problems such as loss of brand reputation, substandard performance, failed applications, and increased cost of production and manufacturing delays. Fairchild is taking strong measures to protect ourselves and our customers from the proliferation of counterfeit parts. Fairchild strongly encourages customers to purchase Fairchild parts either directly from Fairchild or from Authorized Fairchild Distributors who are listed by country on our web page cited above. Products customers buy either from Fairchild directly or from Authorized Fairchild Distributors are genuine parts, have full traceability, meet Fairchild's quality standards for handling and storage and provide access to Fairchild's full range of up-to-date technical and product information. Fairchild and our Authorized Distributors will stand behind all warranties and will appropriately address any warranty issues that may arise. Fairchild will not provide any warranty coverage or other assistance for parts bought from Unauthorized Sources. Fairchild is committed to combat this global problem and encourage our customers to do their part in stopping this practice by buying direct or from authorized distributors.

**PRODUCT STATUS DEFINITIONS**

**Definition of Terms**

Datasheet Identification	Product Status	Definition
Advance Information	Formative / In Design	Datasheet contains the design specifications for product development. Specifications may change in any manner without notice.
Preliminary	First Production	Datasheet contains preliminary data; supplementary data will be published at a later date. Fairchild Semiconductor reserves the right to make changes at any time without notice to improve design.
No Identification Needed	Full Production	Datasheet contains final specifications. Fairchild Semiconductor reserves the right to make changes at any time without notice to improve the design.
Obsolete	Not In Production	Datasheet contains specifications on a product that is discontinued by Fairchild Semiconductor. The datasheet is for reference information only.