

**HIGH EFFICIENCY GREEN MAN6400 SERIES**

**PACKAGE DIMENSIONS**

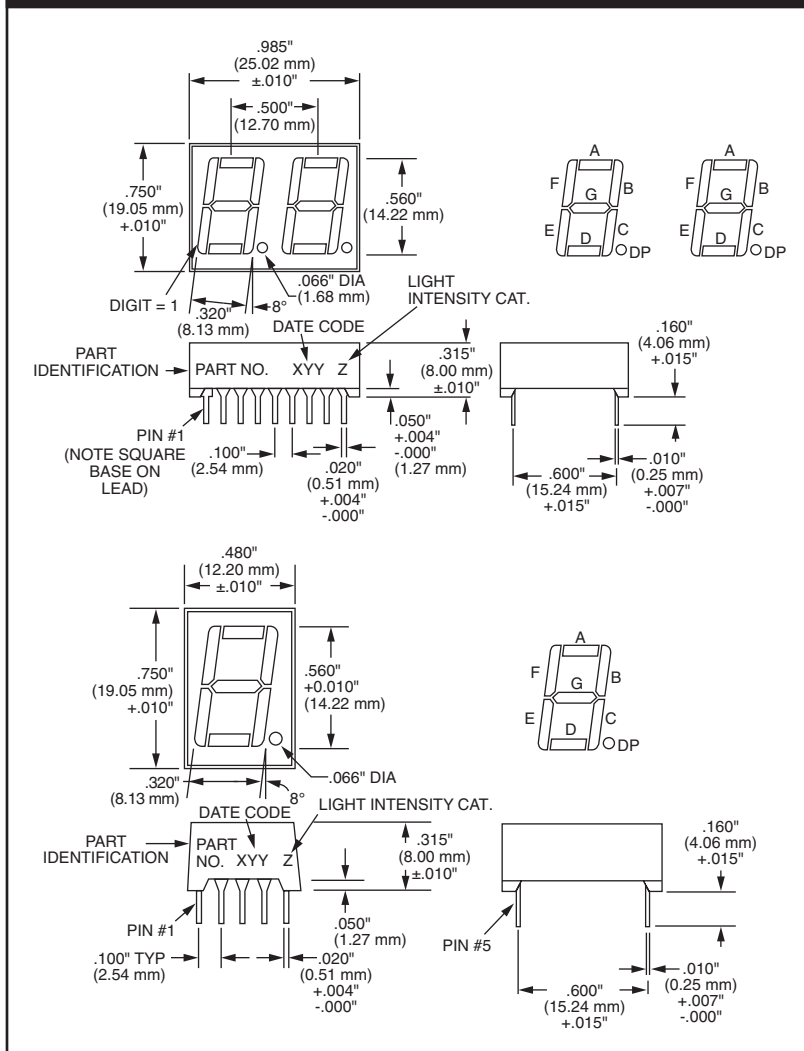

**Description**

The MAN6400 Series is a family of large digits which includes double and single digits. The series features the sculptured font which minimizes “gappiness” at the segment intersections. All models have right hand decimal points and are available in common anode or common cathode configuration. This device has a Grey face and clear segments to enhance ON and OFF contrast.

**Features**

- High Efficiency Green nitrogen-doped GaAsP on GaP
- Large, easy to read, digits
- Common anode or common cathode models
- Fast switching — excellent for multiplexing
- Low power consumption
- Bold solid segments that are highly legible
- Solid state reliability — long operation life
- Rugged plastic construction
- Directly compatible with integrated circuits
- High brightness with high contrast
- Categorized for Luminous Intensity (See Note 5)
- Wide angle viewing...150°
- Low forward voltage
- Two-digit package simplifies alignment and assembly

**Applications**

For industrial and consumer applications such as:

- Digital readout displays
- Instrument panels
- Point of sale equipment
- Digital clocks
- TV and radios

**MODEL NUMBERS**

Part Number	Color	Description	Package Drawing	Pin Out Specification
MAN6410	High Eff. Green	2 Digit; Common Anode; Rt. Hand Decimal	A	A
MAN6440	High Eff. Green	2 Digit; Common Cathode; Rt. Hand Decimal	A	B
MAN6460	High Eff. Green	Single Digit; Common Anode; Rt. Hand Decimal	B	C
MAN6980	High Eff. Green	Single Digit; Common Cathode; Rt. Hand Decimal	B	D

**HIGH EFFICIENCY GREEN MAN6400 SERIES**

**RECOMMENDED OPTICAL FILTERS**

For optimum ON and OFF contrast, one of the following filters or equivalents should be used over the display:

Device Type	Filter
MAN6400 Series	Panelgraphic Green 48 Homalite 100-1440 Green Panelgraphic Grey 10 Homalite 100-1266 Grey

**ELECTRO-OPTICAL CHARACTERISTICS**

(Per Diode 25°C Free Air Temperature Unless Otherwise Specified)

	Min.	Typ.	Max.	Units	Test Conditions
Luminous Intensity, digit average (See Note 1)	510	2200		μcd	I <sub>F</sub> = 10 mA
Peak emission wavelength		565		nm	
Spectral line half width		30		nm	
Forward voltage					
Segment		2.1	2.8	V	I <sub>F</sub> = 20 mA
Decimal point		2.1	2.8	V	I <sub>F</sub> = 20 mA
Dynamic resistance					
Segment		26		Ω	I <sub>F</sub> = 20 mA
Decimal point		26		Ω	I <sub>F</sub> = 20 mA
Capacitance					
Segment		35		pF	V = 0
Decimal point		35		pF	V = 0
Reverse current					
Segment			100	μA	V <sub>R</sub> = 3.0V
Decimal point			100	μA	V <sub>R</sub> = 3.0V
Ratio I <sub>L</sub>			2:1	—	I <sub>F</sub> = 10 mA

**ABSOLUTE MAXIMUM RATINGS**

	MAN64X0
Power dissipation at 25°C ambient	600mW
Derate linearly from 50°C	
Storage and operating temperature	-40°C to +85°C
Continuous forward current	
Total	
Per segment	30 mA
Decimal point	30 mA
Reverse voltage	
Per segment	6.0 V
Decimal point	6.0 V
Soldering time at 260°C (See Notes 3 and 4)	5 sec.

**HIGH EFFICIENCY GREEN MAN6400 SERIES**

<b>TYPICAL THERMAL CHARACTERISTICS</b>	
Thermal resistance junction to free air $\phi_{JA}$	160°C/W
Wavelength temperature coefficient (case temperature)	1.0Å/°C
Forward voltage temperature coefficient	-2.0 mV/°C

Notes:

1. The digit average Luminous Intensity is obtained by summing the Luminous Intensity of each segment and dividing by the total number of segments. Intensity will not vary more than  $\pm 33.3\%$  between all segments within a digit.
2. The curve in Figure 3 is normalized to the brightness at 25°C to indicate the relative efficiency over the operating temperature range.
3. Leads of the device immersed to 1/16 inch from the body. Maximum device surface temperature is 140°C.
4. For flux removal, Freon TF, Freon TE, Isoproponal or water may be used up to their boiling points.
5. All displays are categorized for Luminous Intensity. The Intensity category is marked on each part as a suffix letter to the part number.

<b>ELECTRICAL CONNECTIONS</b>				
<b>Pin No.</b>	<b>ELECTRICAL CONNECTIONS</b>			
	<b>A MAN6410</b>	<b>B MAN6440</b>	<b>C MAN6460</b>	<b>D MAN6480</b>
1	Cathode E 1	Anode E 1	Cathode E	Anode E
2	Cathode D 1	Anode D 1	Cathode D	Anode D
3	Cathode C 1	Anode C 1	Common Anode	Common Cathode
4	Cathode D.P. 1	Anode D.P. 1	Cathode C	Anode C
5	Cathode E 2	Anode E 2	Cathode D.P.	Anode D.P.
6	Cathode D 2	Anode D 2	Cathode B	Anode B
7	Cathode G 2	Anode G 2	Cathode A	Anode A
8	Cathode C 2	Anode C 2	Common Anode	Common Cathode
9	Cathode D.P. 2	Anode D.P. 2	Cathode F	Anode F
10	Cathode B 2	Anode B 2	Cathode G	Anode G
11	Cathode A 2	Anode A 2		
12	Cathode F 2	Anode F 2		
13	Anode Digit 2	Cathode Digit 2		
14	Anode Digit 1	Cathode Digit 1		
15	Cathode B 1	Anode B 1		
16	Cathode A 1	Anode A 1		
17	Cathode G 1	Anode G 1		
18	Cathode F 1	Anode F 1		

**HIGH EFFICIENCY GREEN MAN6400 SERIES**

**TYPICAL CHARACTERISTIC CURVES**

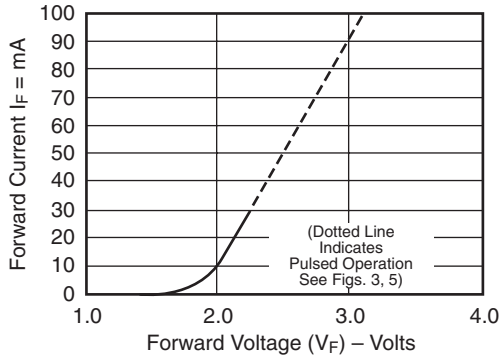

Fig. 1 Forward Current vs. Forward Voltage

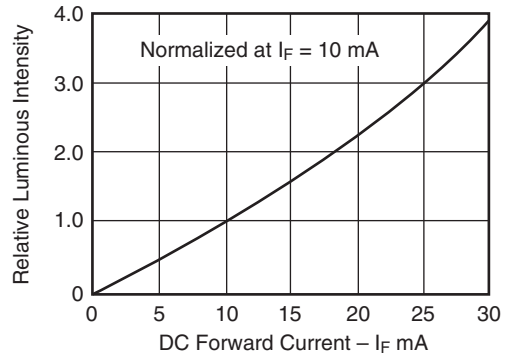

Fig. 2 Relative Luminous Intensity vs. DC Forward Current

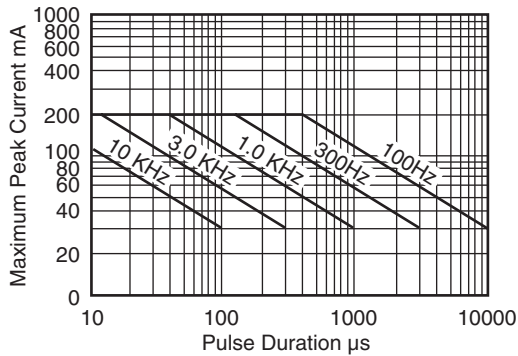

Fig. 3 Maximum Peak Current vs. Pulse Duration

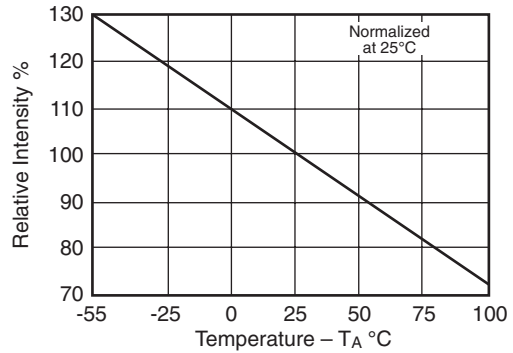

Fig. 4 Relative Luminous Intensity vs. Temperature

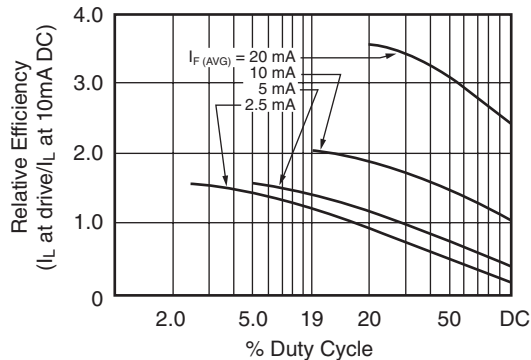
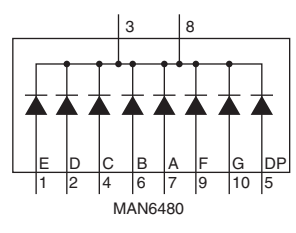
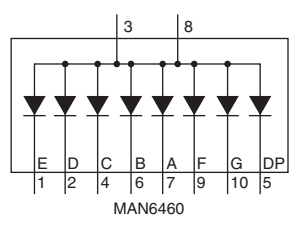
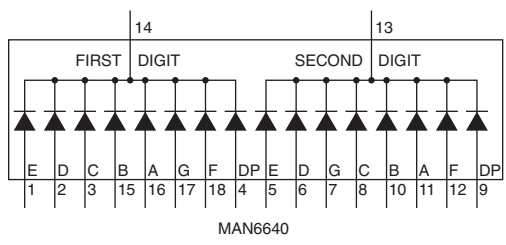
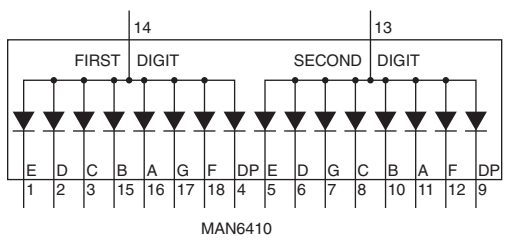

Fig. 5 Relative Efficiency vs. Duty Cycle

**HIGH EFFICIENCY GREEN MAN6400 SERIES**

**INTERNAL CONNECTIONS**



---

## **HIGH EFFICIENCY GREEN MAN6400 SERIES**

---

### **DISCLAIMER**

FAIRCHILD SEMICONDUCTOR RESERVES THE RIGHT TO MAKE CHANGES WITHOUT FURTHER NOTICE TO ANY PRODUCTS HEREIN TO IMPROVE RELIABILITY, FUNCTION OR DESIGN. FAIRCHILD DOES NOT ASSUME ANY LIABILITY ARISING OUT OF THE APPLICATION OR USE OF ANY PRODUCT OR CIRCUIT DESCRIBED HEREIN; NEITHER DOES IT CONVEY ANY LICENSE UNDER ITS PATENT RIGHTS, NOR THE RIGHTS OF OTHERS.

### **LIFE SUPPORT POLICY**

FAIRCHILD'S PRODUCTS ARE NOT AUTHORIZED FOR USE AS CRITICAL COMPONENTS IN LIFE SUPPORT DEVICES OR SYSTEMS WITHOUT THE EXPRESS WRITTEN APPROVAL OF THE PRESIDENT OF FAIRCHILD SEMICONDUCTOR CORPORATION. As used herein:

1. Life support devices or systems are devices or systems which, (a) are intended for surgical implant into the body, or (b) support or sustain life, and (c) whose failure to perform when properly used in accordance with instructions for use provided in the labeling, can be reasonably expected to result in a significant injury of the user.
2. A critical component in any component of a life support device or system whose failure to perform can be reasonably expected to cause the failure of the life support device or system, or to affect its safety or effectiveness.