

High Voltage Operational Amplifiers

Features

- Output Voltage Swing $\pm 35V$
- Supply Voltage $\pm 10V$ to $\pm 40V$
- Offset Current 5nA
- Bandwidth 4MHz
- Slew Rate $5V/\mu s$
- Common Mode Input Voltage Swing $\pm 35V$
- Output Overload Protection

Applications

- Industrial Control Systems
- Power Supplies
- High Voltage Regulators
- Resolver Excitation
- Signal Conditioning

Description

HA-2640 and HA-2645 are monolithic operational amplifiers which are designed to deliver unprecedented dynamic specifications for a high voltage internally compensated device. These dielectrically isolated devices offer very low values for offset voltage and offset current coupled with large output voltage swing and common mode input voltage.

For maximum reliability, these amplifiers offer unconditional output overload protection through current limiting and a chip temperature sensing circuit. This sensing device turns the amplifier "off", when the chip reaches a certain temperature level.

These amplifiers deliver $\pm 35V$ common mode input voltage swing, $\pm 35V$ output voltage swing, and up to $\pm 40V$

supply range for use in such designs as regulators, power supplies, and industrial control systems. 4MHz gain bandwidth and $5V/\mu s$ slew rate make these devices excellent components for high performance signal conditioning applications. Outstanding input and output voltage swings coupled with a low 5nA offset current make these amplifiers excellent components for resolver excitation designs.

The HA-2640/2645 are available in Metal Can (TO-99) or Ceramic Mini-DIP and can be used as high performance pin-for-pin replacements for many general performance amplifiers. HA-2640 is specified from $-55^{\circ}C$ to $+125^{\circ}C$ and HA-2645 is specified over the $0^{\circ}C$ to $+75^{\circ}C$ range.

Pinouts

HA7-2640/2645 (CERAMIC MINI-DIP)
TOP VIEW

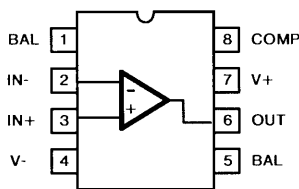

HA2-2640/2645 (TO-99 METAL CAN)
TOP VIEW

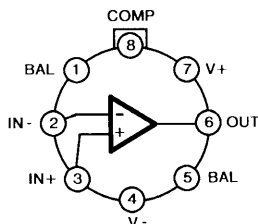

(TO-99 Case Voltage = -V)

Schematic

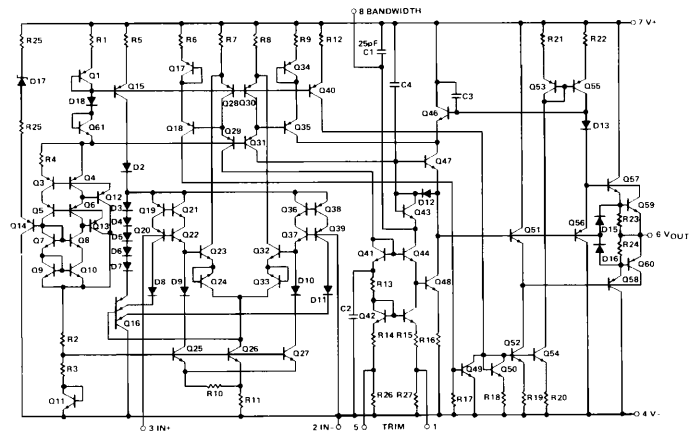

Specifications HA-2640/2645

HA-2640/45

Absolute Maximum Ratings (Note 12)

Voltage Between V+ and V- Terminals 100V
 Input Voltage Range $\pm 10V$ To $\pm 37V$
 Output Current Full Short Circuit Protection
 Internal Power Dissipation 680mW *
 Maximum Junction Temperature +175°C
 * Derate by 4.6mW/°C above +25°C

Operating Temperature Ranges

HA-2640 $-55^{\circ}C \leq T_A \leq +125^{\circ}C$
 HA-2645 $0^{\circ}C \leq T_A \leq +75^{\circ}C$
 Storage Temperature Range $-65^{\circ}C \leq T_A \leq +150^{\circ}C$

Electrical Specifications $V_{SUPPLY} = \pm 40V, R_L = 5k\Omega$, Unless Otherwise Specified.

PARAMETER	TEMP	HA-2640 -55°C to +125°C			HA-2645 0°C to +75°C			UNITS
		MIN	TYP	MAX	MIN	TYP	MAX	
INPUT CHARACTERISTICS								
Offset Voltage	+25°C	-	2	4	-	2	6	mV
	Full	-	-	6	-	-	7	mV
Average Offset Voltage Drift	Full	-	15	-	-	15	-	$\mu V/^{\circ}C$
Bias Current	+25°C	-	10	25	-	12	30	nA
	Full	-	-	50	-	-	50	nA
Offset Current	+25°C	-	5	12	-	15	30	nA
	Full	-	-	35	-	-	50	nA
Input Resistance (Note 10)	+25°C	50	250	-	40	200	-	M Ω
Common Mode Range	Full	± 35	-	-	± 35	-	-	V
TRANSFER CHARACTERISTICS								
Large Signal Voltage Gain (Notes 8)	+25°C	100K	200K	-	100K	200K	-	V/V
	Full	75K	-	-	75K	-	-	V/V
Common Mode Rejection Ratio (Note 1)	Full	80	100	-	74	100	-	dB
Minimum Stable Gain	+25°C	1	-	-	1	-	-	V/V
Unity Gain Bandwidth (Note 2)	+25°C	-	4	-	-	4	-	MHz
OUTPUT CHARACTERISTICS								
Output Voltage Swing	Full	± 35	-	-	± 35	-	-	V
Output Current (Note 9)	+25°C	± 12	± 15	-	± 10	± 12	-	mA
Output Resistance	+25°C	-	500	-	-	500	-	Ω
Full Power Bandwidth (Notes 3 & 11)	+25°C	-	23	-	-	23	-	kHz
TRANSIENT RESPONSE (Note 7)								
Rise Time (Notes 4 & 6)	+25°C	-	60	100	-	60	100	ns
Overshoot (Notes 4 & 6)	+25°C	-	15	30	-	15	40	%
Slew Rate (Note 6)	+25°C	± 3	± 5	-	± 2.5	± 5	-	V/ μs
POWER SUPPLY CHARACTERISTICS								
Supply Current	+25°C	-	3.2	3.8	-	3.2	4.5	mA
Supply Voltage Range	Full	± 10	-	± 40	± 10	-	± 40	V
Power Supply Rejection Ratio (Note 5)	Full	80	90	-	74	90	-	dB

NOTES

- $V_{CM} = \pm 20V$
- $V_{OUT} = 90mV$
- $V_{OUT} = \pm 35V$
- $V_{OUT} = \pm 200mV$
- $V_S = \pm 10V$ to $\pm 40V$
- $A_V = +1$
- $C_L = 50pF, R_L = 5k\Omega$
- $V_{OUT} = \pm 30V$
- $R_L = 1k\Omega$
- This parameter based upon design calculations
- Full Power Bandwidth guaranteed based upon slew rate measurement:
 $FPBW = S.R./2\pi V_{PEAK}$
- Absolute Maximum Ratings are limiting values applied individually beyond which the serviceability of the circuit may be impaired. Functional operation under any of these conditions is not necessarily implied.

2

OP AMPS & COMPARATORS

Typical Performance Curves $V_+ = V_- = 40V$ D.C., $T_A = +25^\circ C$, Unless Otherwise Specified.

INPUT BIAS AND OFFSET CURRENT vs. TEMPERATURE

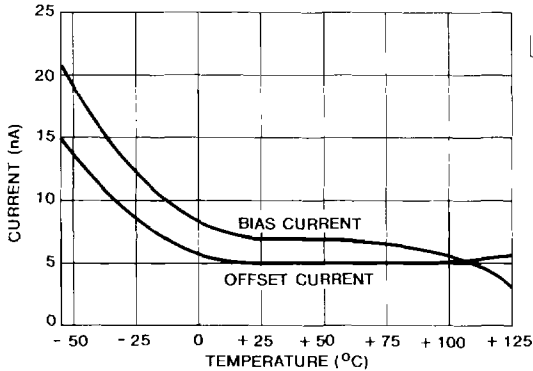

INPUT NOISE CHARACTERISTICS

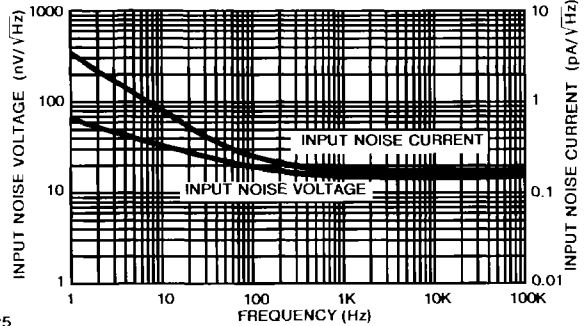

NORMALIZED AC PARAMETERS vs. TEMPERATURE

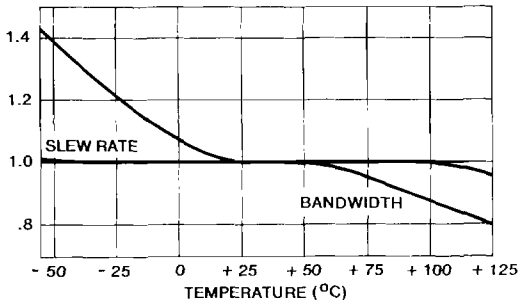

OPEN LOOP FREQUENCY AND PHASE RESPONSE

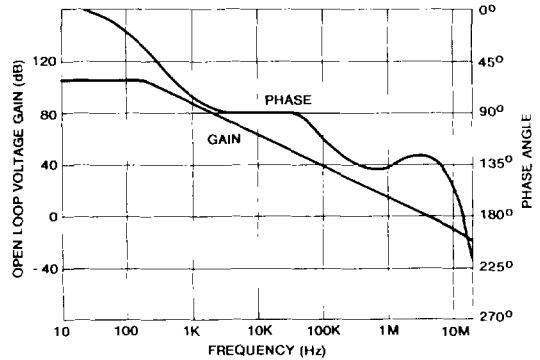

NORMALIZED AC PARAMETERS vs. SUPPLY VOLTAGE AT +25°C

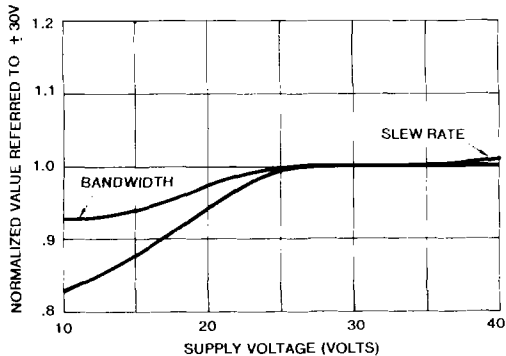

OPEN - LOOP FREQUENCY RESPONSE FOR VARIOUS VALUES OF CAPACITORS FROM COMPENSATION PIN TO GROUND

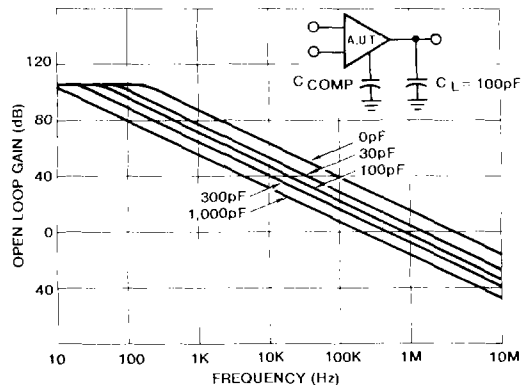

NOTE: External Compensation Components are not required for stability, but may be added to reduce bandwidth if desired. If External Compensation is used, also connect 100pF capacitor from output to ground.

Typical Performance Curves (Continued)

OUTPUT VOLTAGE SWING vs. FREQUENCY AT +25°C

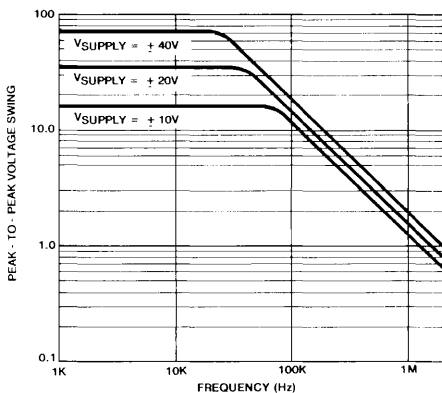

OUTPUT CURRENT CHARACTERISTIC

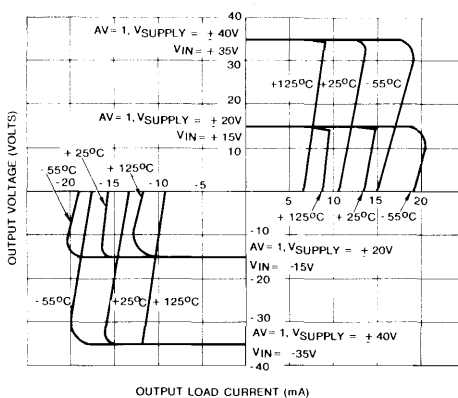

Switching Waveform and Test Circuits

VOLTAGE FOLLOWER PULSE RESPONSE

$R_L = 5K$, $C_L = 50pF$ $T_A = +25^\circ C$
 Vertical = 10V/Div. $V_S = \pm 40V$
 Horizontal = 5 μs /Div.

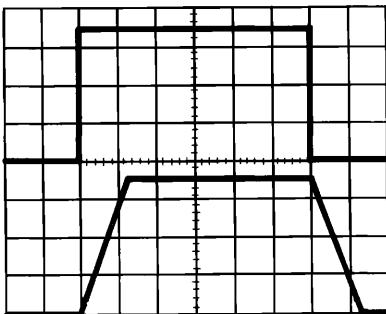

SLEW RATE AND TRANSIENT RESPONSE TEST CIRCUIT

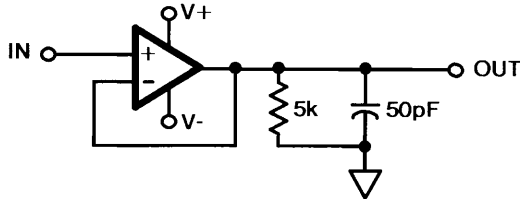

SUGGESTED V_{OS} ADJUSTMENT

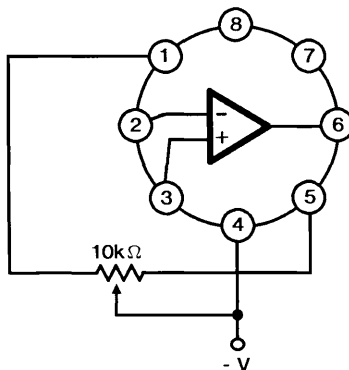

Tested Offset Adjustment Range is $|V_{OS} + 1mV|$ minimum referred to output. Typical range is $\pm 20mV$ with $R_T = 10k\Omega$.