

MAXIM

Phase-Reversal Analog Switches

MAX4526/MAX4527

General Description

The MAX4526/MAX4527 are CMOS analog ICs configured as phase-reversal switches. The MAX4526 is optimized for high-speed applications, such as chopper amplifiers, while the MAX4527 is optimized for low-power applications.

The MAX4526/MAX4527 operate from a +4.5V to +36V single supply or $\pm 4.5V$ to $\pm 18V$ dual supplies. On-resistance (175Ω max) is matched between switches to 8Ω maximum. Each switch can handle rail-to-rail analog signals. Maximum leakage current is only $0.5nA$ at $+25^\circ C$ and $10nA$ at $+85^\circ C$.

All digital inputs have $0.8V$ to $2.4V$ logic thresholds, ensuring TTL/CMOS-logic compatibility.

Features

- ◆ 10pC (max) Charge Injection
- ◆ 2pC (max) Charge-Injection Match
- ◆ 175Ω Signal Paths with $\pm 15V$ Supplies
- ◆ Guaranteed Break-Before-Make
- ◆ Rail-to-Rail Signal Handling
- ◆ Transition Time $< 100ns$ with $\pm 15V$ Supplies
- ◆ $1\mu A$ Current Consumption (MAX4527)
- ◆ $> 2kV$ ESD Protection per Method 3015.7
- ◆ TTL/CMOS-Compatible Inputs
- ◆ Available in Small, 8-Pin μMAX Package

Applications

Chopper-Stabilized Amplifiers
 Balanced Modulators/Demodulators
 Data Acquisition
 Test Equipment
 Audio-Signal Routing

Ordering Information

PART	TEMP. RANGE	PIN-PACKAGE
MAX4526CPA	$0^\circ C$ to $+70^\circ C$	8 Plastic DIP
MAX4526CSA	$0^\circ C$ to $+70^\circ C$	8 SO
MAX4526CUA	$0^\circ C$ to $+70^\circ C$	8 μMAX
MAX4526C/D	$0^\circ C$ to $+70^\circ C$	Dice*
MAX4526EPA	$-40^\circ C$ to $+85^\circ C$	8 Plastic DIP
MAX4526ESA	$-40^\circ C$ to $+85^\circ C$	8 SO
MAX4526EUA	$-40^\circ C$ to $+85^\circ C$	8 μMAX

Ordering Information continued at end of data sheet.

*Contact factory for availability.

Pin Configuration/Functional Diagram/Truth Table

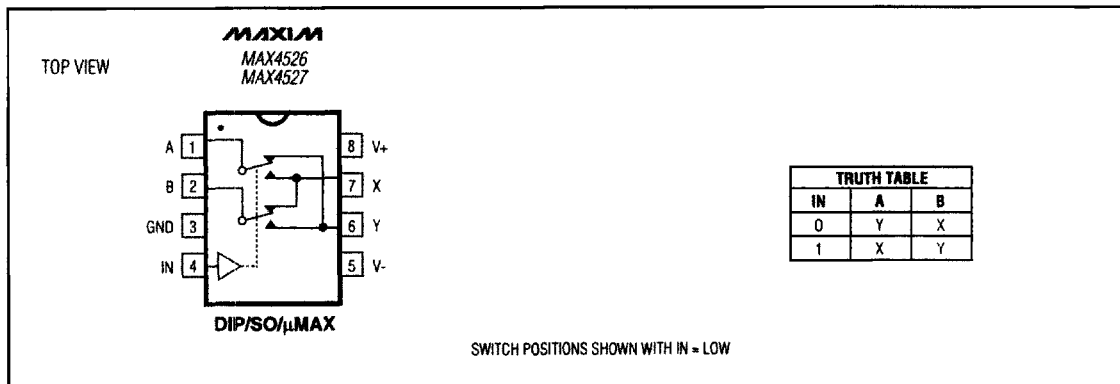

MAXIM

Maxim Integrated Products 1-21

For free samples & the latest literature: <http://www.maxim-ic.com>, or phone 1-800-998-8800
 For small orders, phone 408-737-7600 ext. 3468.

Phase-Reversal Analog Switches

ABSOLUTE MAXIMUM RATINGS

(Voltages Referenced to GND)

V+	-0.3V to +44V
V-	-25V to +0.3V
V+ to V-	-0.3V to +44V
All Other Pins (Note 1)	(V- - 0.3V) to (V+ + 0.3V)
Continuous Current into Any Terminal	±20mA
Peak Current into Any Terminal (pulsed at 1ms, 10% duty cycle)	±30mA
ESD per Method 3015.7	>2000V

Continuous Power Dissipation (T _A = +70°C)	
Plastic DIP (derate 9.09mW/°C above +70°C)	727mW
SO (derate 5.88mW/°C above +70°C)	471mW
µMAX (derate 4.1mW/°C above +70°C)	330mW
Operating Temperature Ranges	
MAX452_C_A	0°C to +70°C
MAX452_E_A	-40°C to +85°C
Storage Temperature Range	-65°C to +150°C
Lead Temperature (soldering, 10sec)	+300°C

Note 1: Signals on IN, A, B, X, or Y exceeding V+ or V- are clamped by internal diodes. Limit forward-diode current to maximum current rating.

Stresses beyond those listed under "Absolute Maximum Ratings" may cause permanent damage to the device. These are stress ratings only, and functional operation of the device at these or any other conditions beyond those indicated in the operational sections of the specifications is not implied. Exposure to absolute maximum rating conditions for extended periods may affect device reliability.

ELECTRICAL CHARACTERISTICS—±15V Supplies

(V+ = +15V, V- = -15V, V_{INH} = 2.4V, V_{INL} = 0.8V, T_A = T_{MIN} to T_{MAX}, unless otherwise noted. Typical values are at T_A = +25°C.)

PARAMETER	SYMBOL	CONDITIONS	T _A	MIN	TYP (Note 2)	MAX	UNITS
ANALOG SWITCH							
Analog-Signal Range	V _A , V _B , V _X , V _Y	(Note 3)	C, E	-V		V+	V
A-X, A-Y, B-X, B-Y On-Resistance	R _{ON}	V _A = V _B = ±10V, I _A = I _B = 1mA	+25°C		105	175	Ω
			C, E			200	
A-X, A-Y, B-X, B-Y On-Resistance Match (Note 4)	ΔR _{ON}	V _A = V _B = ±10V, I _A = I _B = 1mA	+25°C		0.5	8	Ω
			C, E			10	
A-X, A-Y, B-X, B-Y On-Resistance Flatness (Note 5)	R _{FLAT(ON)}	V _A = V _B = -5V, 0V, +5V; I _A = I _B = 1mA	+25°C		12	18	Ω
			C, E			30	
A, B, X, Y Leakage Current (Note 6)	I _{A(OFF)} , I _{B(OFF)} , I _{X(OFF)} , I _{Y(OFF)}	V+ = 16.5V, V- = -16.5V; V _{IN} = 0V, 3V; V _A = ±15.5V, V _B = ±15.5V	+25°C	-0.5	0.01	0.5	nA
			C, E	-10		10	
LOGIC INPUT							
IN Input Logic Threshold High	V _{INH}		C, E		1.6	2.4	V
IN Input Logic Threshold Low	V _{INL}		C, E	0.8	1.6		V
IN Input Current Logic High or Low	I _{INH} , I _{INL}	V _{INL} = 0.8V or 2.4V	C, E	1	0.03	1	µA

Phase-Reversal Analog Switches

MAX4526/MAX4527

ELECTRICAL CHARACTERISTICS—±15V Supplies (continued)

(V+ = +15V, V- = -15V, VINH = 2.4V, VINL = 0.8V, TA = TMIN to TMAX, unless otherwise noted. Typical values are at TA = +25°C.)

PARAMETER	SYMBOL	CONDITIONS	TA	MIN	TYP (Note 2)	MAX	UNITS
SWITCH DYNAMIC CHARACTERISTICS							
Transition Time	tTRANS	VA = VB = ±10V, V+ = 15V, V- = -15V, Figure 3	MAX4526	+25°C	65	100	ns
				C, E		125	
			MAX4527	+25°C	95	200	
				C, E		250	
Break-Before-Make Time Delay	tBBM	VA = VB = ±10V, V+ = 15V, V- = -15V, Figure 4	+25°C	1	5		ns
Charge Injection (Note 3)	Q	CL = 1.0nF, VA or VB = 0V, RS = 0Ω, Figure 5	+25°C		1	10	pC
A-X, A-Y, B-X, B-Y Capacitance	COFF	VA = VB = GND, f = 1MHz, Figure 6	+25°C		13		pF
A-X, A-Y, B-X, B-Y Isolation (Note 7)	VISO	RL = 50Ω, CL = 15pF, VA = VB = 1VRMS, f = 1MHz, Figure 7	+25°C		-65		dB
POWER SUPPLY							
Power-Supply Range	V+, V-		C, E	±4.5		±20	V
V+ Supply Current	I+	V+ = 16.5V, VIN = 0V or V+	MAX4526	+25°C	0.7	1	mA
				C, E		1.5	
			MAX4527	+25°C	0.05	1	μA
				C, E		10	
V- Supply Current	I-	V- = -16.5V	MAX4526	+25°C	-400		μA
				C, E		-500	
			MAX4527	+25°C	-1	0.05	
				C, E		-1	

Note 2: The algebraic convention is used in this data sheet; the most negative value is shown in the minimum column.

Note 3: Guaranteed by design.

Note 4: $\Delta R_{ON} = \Delta R_{ON(MAX)} - \Delta R_{ON(MIN)}$.

Note 5: Resistance flatness is defined as the difference between the maximum and minimum values of on-resistance as measured over the specified analog-signal range.

Note 6: Leakage current is 100% tested at maximum rated hot temperature, and is guaranteed by correlation at TA = +25°C and minimum rated cold temperature.

Note 7: Off-isolation = $20 \log_{10} [(V_X \text{ or } V_Y) / (V_A \text{ or } V_B)]$, VX or VY = output, VA or VB = input to off switch.

Phase-Reversal Analog Switches

Typical Operating Characteristics

($V_+ = +15V$, $V_- = -15V$, GND = 0V, $T_A = +25^\circ C$, unless otherwise noted.)

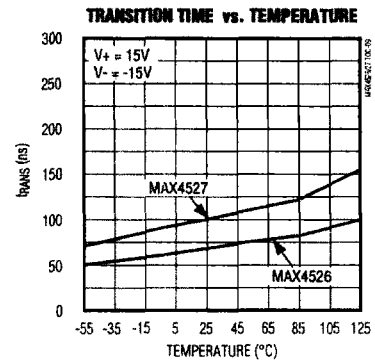
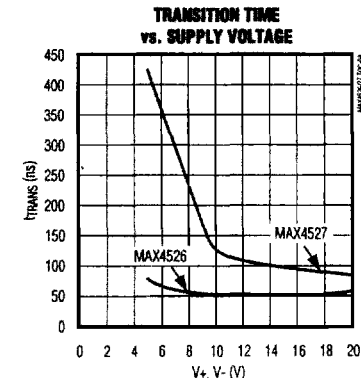
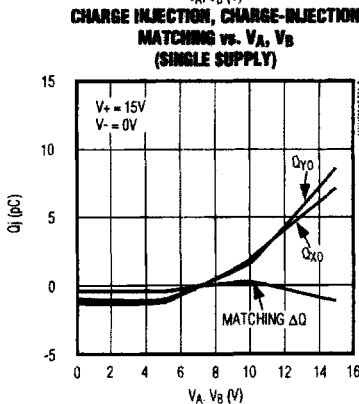
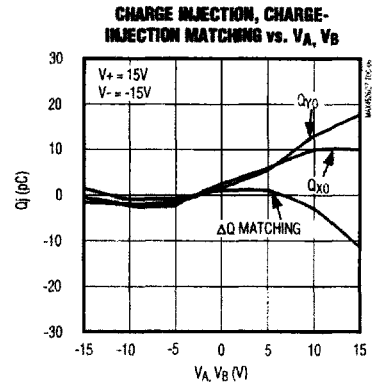
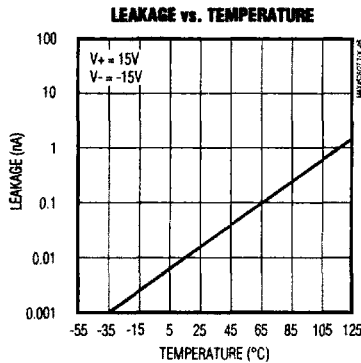
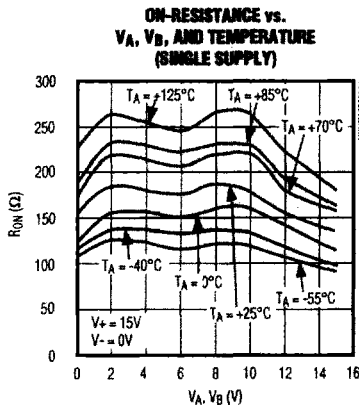
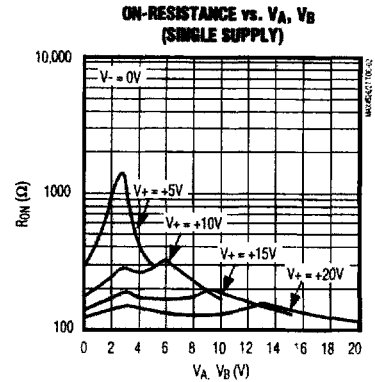
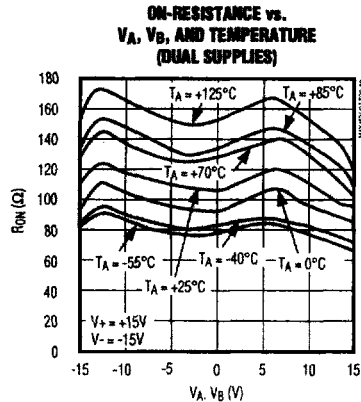
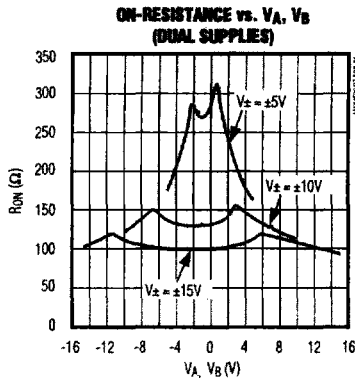

Phase-Reversal Analog Switches

Typical Operating Characteristics (continued)

($V_+ = +15V$, $V_- = -15V$, $GND = 0V$, $T_A = +25^\circ C$, unless otherwise noted.)

MAX4526/MAX4527

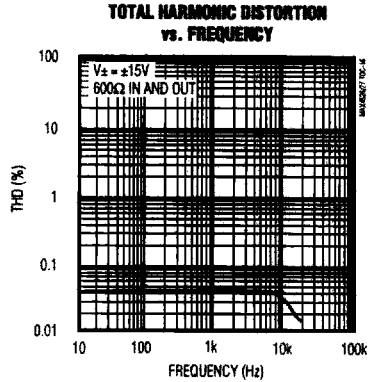
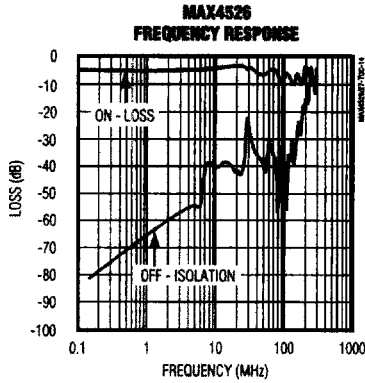
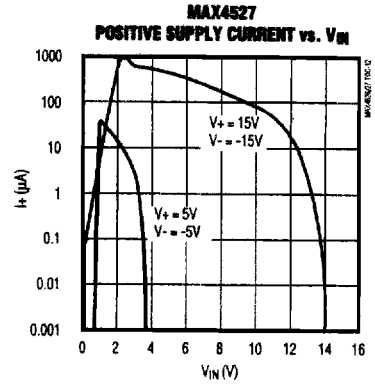
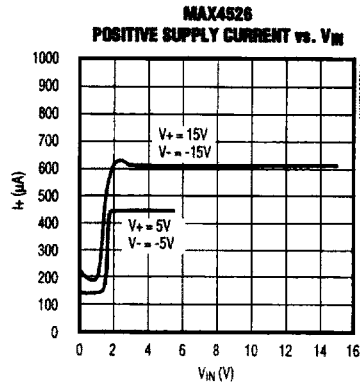
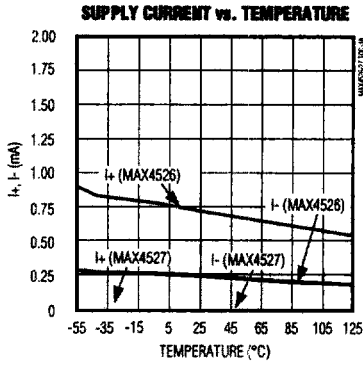

Phase-Reversal Analog Switches

Pin Configuration

PIN	NAME	FUNCTION
1	A	Analog-Switch Input Terminal A. Connected to Y when IN is low; connected to X when IN is high.
2	B	Analog-Switch Input Terminal B. Connected to X when IN is low; connected to Y when IN is high.
3	GND	Ground. Connect GND to digital ground. (Analog signals have no ground reference; they are limited to V+ and V-.)
4	IN	Logic-Level Control Inputs (see <i>Truth Table</i>).
5	V-	Negative Analog Supply-Voltage Input. Connect V- to GND for single-supply operation.
6	Y	Analog-Switch Output Terminal Y.
7	X	Analog-Switch Output Terminal X.
8	V+	Positive Analog/Digital Supply-Voltage Input. Internally connected to substrate.

Note: A, B, X and Y pins are identical and interchangeable. Either may be considered as an input or output; signals pass equally well in either direction. However, AC symmetry is best when A and B are the input; and X and Y are the output. Reduce AC balance in critical applications by using A and X or A and Y as the input, and B and Y or B and X as the output.

Detailed Description

The MAX4526/MAX4527 are phase-reversal analog switches, consisting of two normally open and two normally closed CMOS analog switches arranged in a bridge configuration. Analog signals are put into two input pins and taken out of two output pins. A logic-level signal controls whether the input signal is routed through normally or inverted. A low-resistance DC path goes from inputs to outputs at all times, yet isolation between the two signal paths is excellent. Analog signals range from V- to V+.

These parts are characterized and optimized with $\pm 15V$ supplies, and they can operate from a single supply. The MAX4526 is optimized for high-frequency operation, and has a higher-speed logic-level translator and switch driver. The MAX4527 has identical analog switch characteristics, but has a slower logic-level translator and switch driver for lower current consumption.

The MAX4526/MAX4527 are designed for DC and low-frequency-signal phase-reversal applications, such as chopper amplifiers, modulator/demodulators, and self-zeroing or self-calibrating circuits. Unlike conventional CMOS switches externally wired in a bridge configuration, both DC and AC symmetry are optimized with a small 8-pin configuration that allows simple board layout and isolation of logic signals from analog signals.

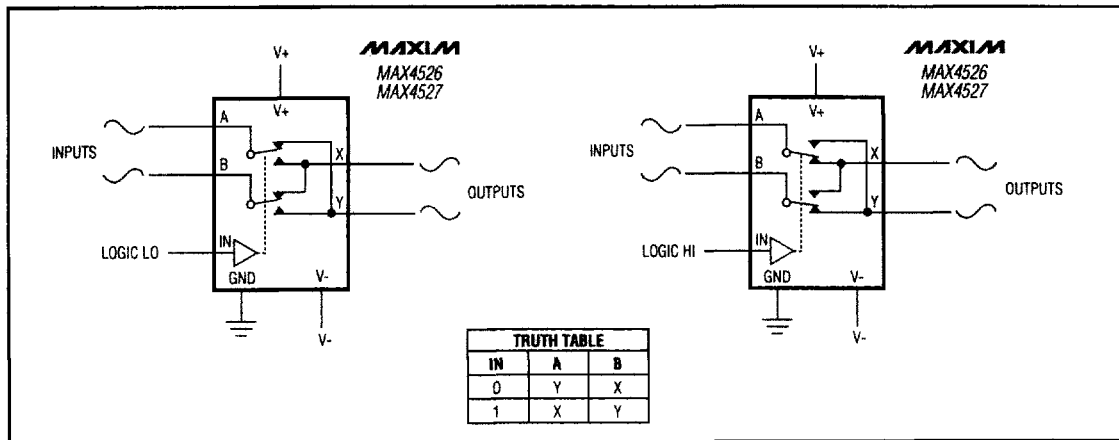

Figure 1. Typical Application Circuits

Phase-Reversal Analog Switches

Power-Supply Considerations

Overview

The MAX4526/MAX4527 construction is typical of most CMOS analog switches. It has three supply pins: V_+ , V_- , and GND. V_+ and V_- drive the internal CMOS switches and set the analog-voltage limits on any switch. Reverse ESD-protection diodes are internally connected between each analog signal pin, and both V_+ and V_- . One of these diodes conducts if any analog signal exceeds V_+ or V_- .

Virtually all of the analog leakage current is through the ESD diodes to V_+ or V_- . Although the ESD diodes on a given signal pin are identical and therefore fairly well balanced, they are reverse biased differently. Each is biased by either V_+ or V_- and the analog signal. This means their leakages vary as the signal varies. The difference in the two diode leakages from the signal path to the V_+ and V_- pins constitutes the analog-signal-path leakage current. All analog leakage current flows to the supply terminals, not to the other switch terminal. This explains how both sides of a given switch can show leakage currents of either the same or opposite polarity.

There is no connection between the analog-signal paths and GND. The analog-signal paths consist of an N-channel and P-channel MOSFET with their sources and drains paralleled and their gates driven out-of-phase to V_+ and V_- by the logic-level translators.

V_+ and GND power the internal logic and logic-level translator and set the input logic threshold. The logic-level translator converts the logic levels to switched V_+ and V_- signals to drive the analog switches' gates. This drive signal is the only connection between GND and the analog supplies. V_+ and V_- have ESD-protection diodes to GND. The logic-level input has ESD protection to V_+ and to V_- but not to GND, so the logic signal can go below GND (as low as V_-) when bipolar supplies are used.

Increasing V_- has no effect on the logic-level thresholds, but it does increase the drive to the internal P-channel switches, reducing the overall switch on-resistance. V_- also sets the negative limit of the analog-signal voltage.

The logic-level input pin, IN, has ESD-protection diodes to V_+ and V_- but not to GND, so it can be safely driven to V_+ and V_- . The logic-level threshold, V_{IN} , is CMOS/TTL compatible when V_+ is between 4.5V and 36V (see *Typical Operating Characteristics*).

Bipolar Supplies

The MAX4526/MAX4527 operate with bipolar supplies between $\pm 4.5V$ and $\pm 18V$. However, since all factory characterization is done with $\pm 15V$ supplies, specifications at other supplies are not guaranteed. The V_+ and V_- supplies need not be symmetrical, but their sum cannot exceed the absolute maximum rating of 44V (see *Absolute Maximum Ratings*).

MAX4526/MAX4527

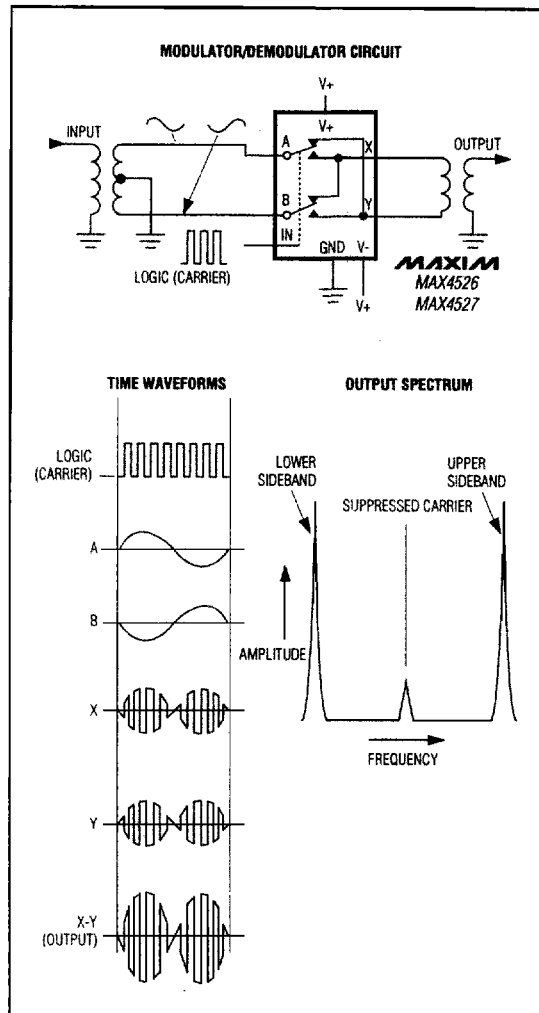

Figure 2. Balanced Modulator/Demodulator

Phase-Reversal Analog Switches

Single Supply

The MAX4526/MAX4527 operate from a single supply between +4.5V and +36V when V- is connected to GND. Observe all of the bipolar precautions when operating from a single supply.

Applications Information

The MAX4526/MAX4527 are designed for DC and low-frequency-signal phase-reversal applications. Both DC and AC symmetry are optimized for use with $\pm 15V$ supplies.

Signal Phase/Polarity Reversal

The MAX4526/MAX4527 can reverse the phase or polarity of a pair of signals that are out-of-phase and balanced to ground. This is done by routing signals through the MAX4526/MAX4527 and under control of the IN pin, reversing the two signals paths inside the switch before sending out to a balanced output. Figure 1 shows a typical example. **The MAX4526/MAX4527 cannot reverse the phase or polarity of a single-grounded signal, as can be done with an inverting op amp or transformer.**

Balanced Modulators/Demodulators

The MAX4526/MAX4527 can be used as a balanced modulator/demodulator at carrier frequencies up to 100kHz (Figure 2). Higher frequencies are possible, but as frequency increases, small imbalances in the

MAX4526/MAX4527's internal capacitance and resistance gradually impair performance. Similarly, imbalances in external circuit capacitance and resistance to GND reduce overall carrier suppression.

The carrier is applied as a logic-level square wave to IN. (Note that this voltage can go as negative as V-) For best carrier suppression, the power-supply voltages should be equal, the square wave should have a precise 50% duty cycle, and both the input and output signals should be symmetrical about ground. Bypass V+ and V- to GND with 0.1 μ F ceramic capacitors, as close to the IC pins as possible. Since the logic-level translator/driver in the MAX4526 is faster than the one in the MAX4527, it gives better results at higher frequencies. In critical applications, carrier suppression can be optimized by trimming duty cycle, DC bias around GND, or external source and load capacitance.

In signal lines, balancing both capacitance and resistance to GND produces the best carrier suppression.

Transformer coupling of input and output signals provides the best isolation and carrier suppression. Transformers can also provide signal filtering, impedance matching, or low-noise voltage gain. Use a center-tapped transformer or high-resistance voltage divider to provide a DC path to GND on either the input signal or output signal. This ensures a DC path to GND and symmetrical operation of the internal switches.

Test Circuits/Timing Diagrams

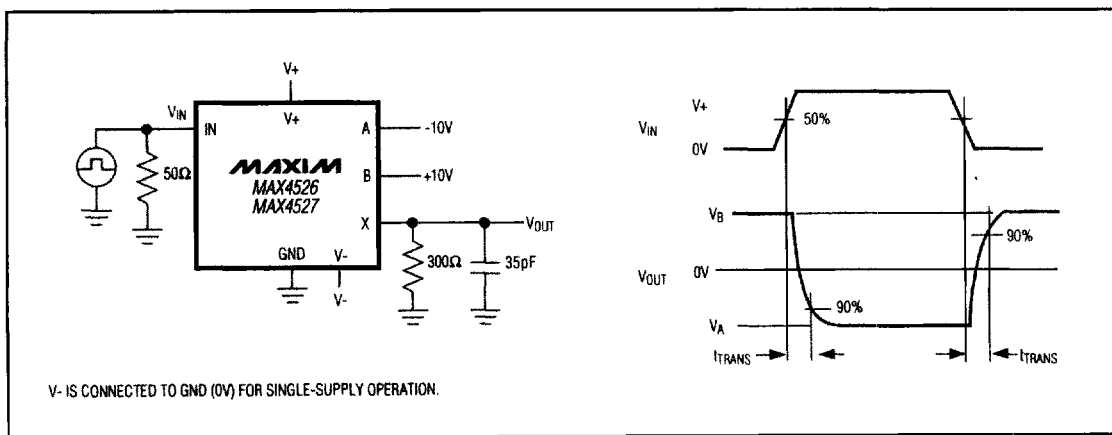

Figure 3. Address Transition Time

Phase-Reversal Analog Switches

Test Circuits/Timing Diagrams (continued)

MAX4526/MAX4527

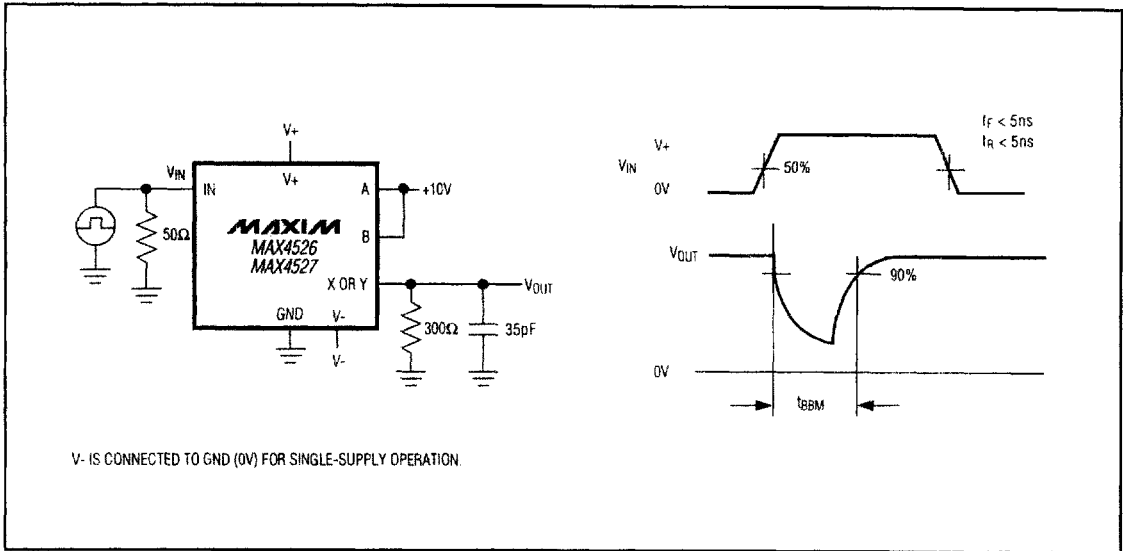

Figure 4. Break-Before-Make Interval

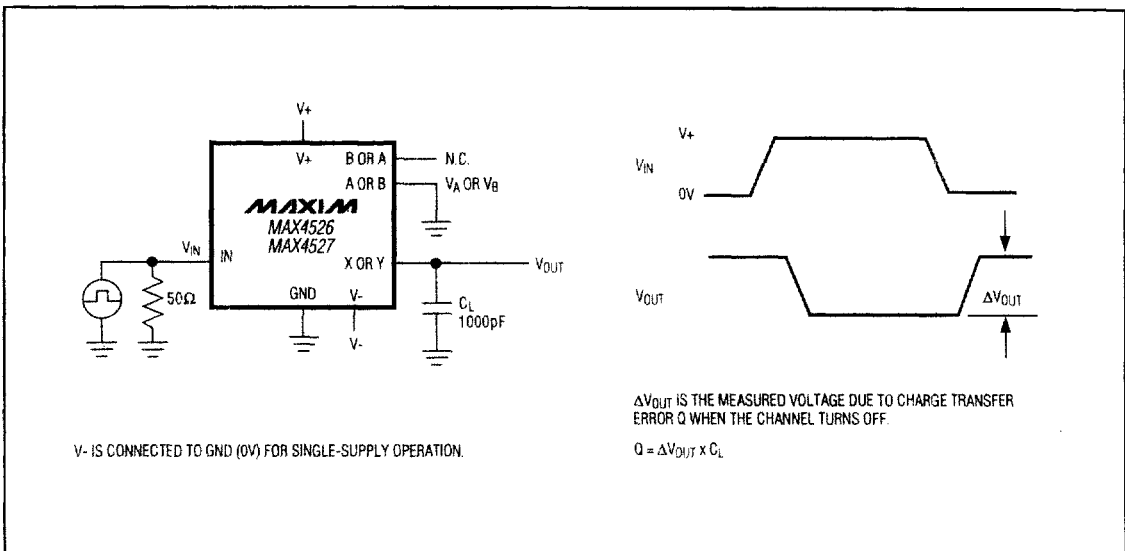

Figure 5. Charge Injection

Phase-Reversal Analog Switches

Test Circuits/Timing Diagrams (continued)

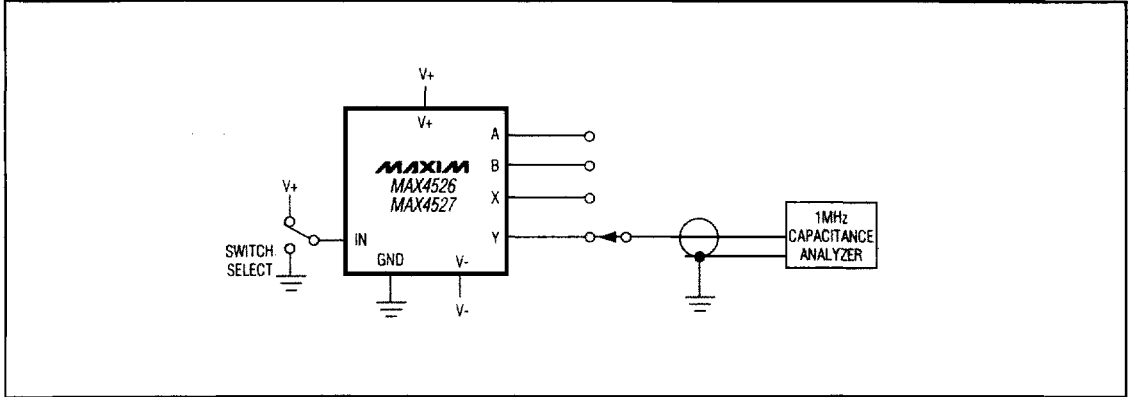

Figure 6. A, B, X, Y Capacitance

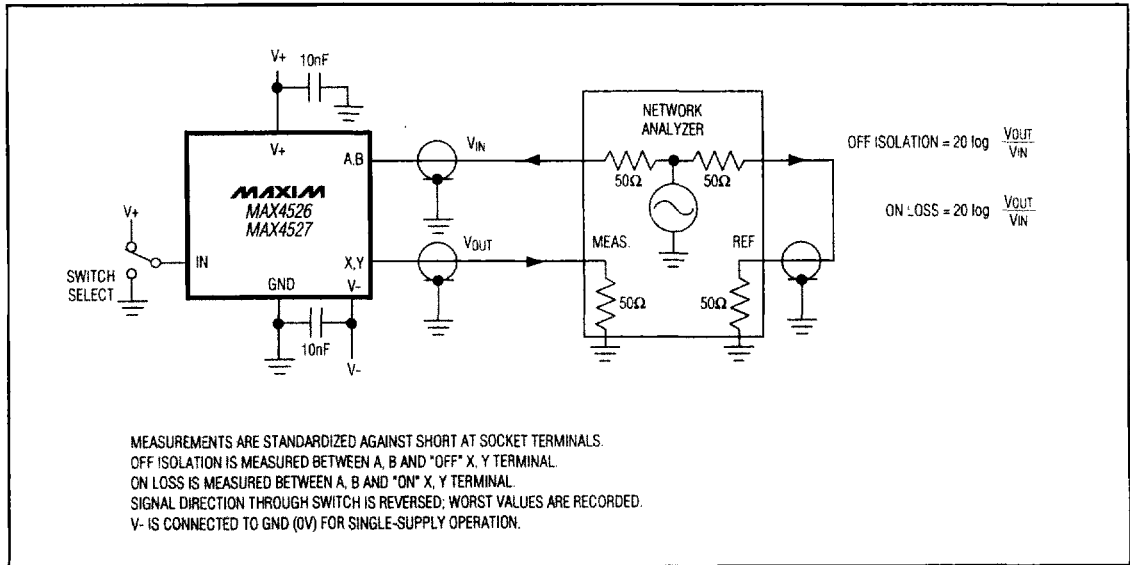

Figure 7. Off Isolation and On Loss

Phase-Reversal Analog Switches

Ordering Information (continued)

PART	TEMP. RANGE	PIN-PACKAGE
MAX4527CPA	0°C to +70°C	8 Plastic DIP
MAX4527CSA	0°C to +70°C	8 SO
MAX4527CUA	0°C to +70°C	8 μ MAX
MAX4527C/D	0°C to +70°C	Dice*
MAX4527EPA	-40°C to +85°C	8 Plastic DIP
MAX4527ESA	-40°C to +85°C	8 SO
MAX4527EUA	-40°C to +85°C	8 μ MAX

*Contact factory for availability.

Chip Topography

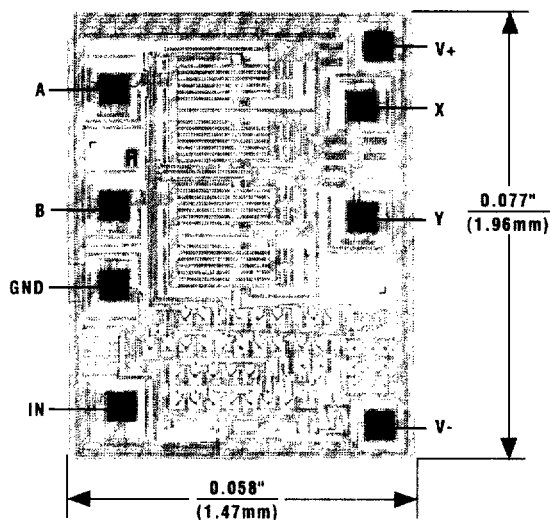

MAX4526/MAX4527

TRANSISTOR COUNT: 50

SUBSTRATE IS INTERNALLY CONNECTED TO V+