

National Semiconductor is now part of  
Texas Instruments.

Search <http://www.ti.com/> for the latest technical  
information and details on our current products and services.

# 265mW at 3.3V Supply Audio Power Amplifier with Shutdown Mode

### General Description

The LM4902 is a bridged audio power amplifier capable of delivering 265mW of continuous average power into an 8Ω load with 1% THD+N from a 3.3V power supply.

Boomer® audio power amplifiers were designed specifically to provide high quality output power from a low supply voltage while requiring a minimal amount of external components. Since the LM4902 does not require output coupling capacitors, bootstrap capacitors or snubber networks, it is optimally suited for low-power portable applications.

The LM4902 features an externally controlled, low power consumption shutdown mode, and thermal shutdown protection.

The closed loop response of the unity-gain stable LM4902 can be configured by external gain-setting resistors.

### Features

- MSOP and LLP packaging
- No output coupling capacitors, bootstrap capacitors, or snubber circuits are necessary
- Thermal shutdown protection circuitry
- Unity-gain stable
- External gain configuration capability
- Latest generation "click and pop" suppression circuitry

### Applications

- Cellular phones
- PDA's
- Any portable audio application

### Key Specifications

- THD+N at 1kHz for 265mW continuous average output power into 8Ω,  $V_{DD} = 3.3V$  1.0% (max)
- THD+N at 1kHz for 675mW continuous average output power into 8Ω,  $V_{DD} = 5V$  1.0% (max)
- Shutdown current 0.1μA (typ)

### Typical Application

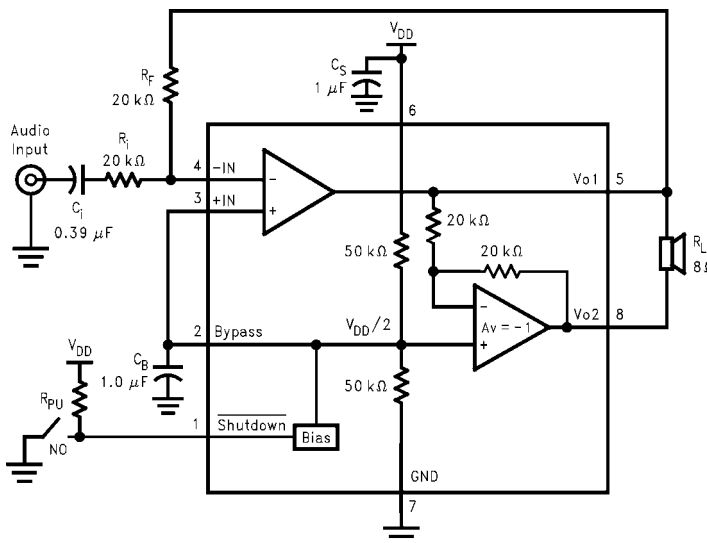

20029801

FIGURE 1. Typical Audio Amplifier Application Circuit

# Connection Diagrams

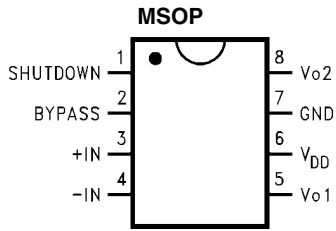

**Top View**  
Order Number LM4902MM  
See NS Package Number MUA08A

20029802

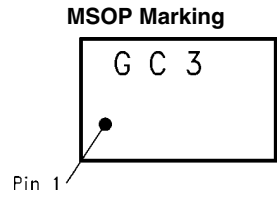

**Top View**  
G - Boomer Family  
C3 - LM4902MM

20029878

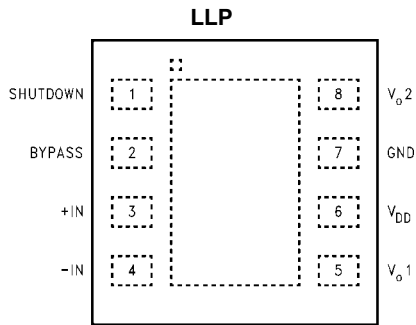

**Top View**  
Order Number LM4902LD  
See NS Package Number LDA08B

20029875

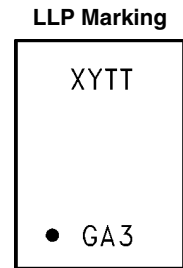

**Top View**  
XY - Date Code  
TT - Die Traceability  
G - Boomer Family  
A3 - LM4902LD

20029877

## Absolute Maximum Ratings (Note 2)

If Military/Aerospace specified devices are required, please contact the National Semiconductor Sales Office/Distributors for availability and specifications.

Supply Voltage	6.0V
Storage Temperature	-65°C to +150°C
Input Voltage	-0.3V to $V_{DD} + 0.3V$
Power Dissipation <small>(Note 3)</small>	Internally limited
ESD Susceptibility <small>(Note 4)</small>	2000V
ESD Susceptibility <small>(Note 5)</small>	200V
Junction Temperature	150°C
Soldering Information	
Small Outline Package	
Vapor Phase (60 sec.)	215°C

Infrared (15 sec.)

220°C

See AN-450 "Surface Mounting and their Effects on Product Reliability" for other methods of soldering surface mount devices.

Thermal Resistance

$\theta_{JC}$ (MSOP)	56°C/W
$\theta_{JA}$ (MSOP)	190°C/W
$\theta_{JA}$ (LLP)	67°C/W

## Operating Ratings

Temperature Range

$$T_{MIN} \leq T_A \leq T_{MAX}$$

$$-40^\circ\text{C} \leq T_A \leq +85^\circ\text{C}$$

Supply Voltage

$$2.0V \leq V_{DD} \leq 5.5V$$

## Electrical Characteristics (Note 1, Note 2)

The following specifications apply for  $V_{DD} = 5V$ , for all available packages, unless otherwise specified. Limits apply for  $T_A = 25^\circ\text{C}$ .

Symbol	Parameter	Conditions	LM4902		Units (Limits)
			Typical <small>(Note 6)</small>	Limit <small>(Note 7, Note 9)</small>	
$I_{DD}$	Quiescent Power Supply Current	$V_{IN} = 0V, I_O = 0A$ <small>(Note 8)</small>	4	6.0	mA (max)
$I_{SD}$	Shutdown Current	$V_{PIN1} = GND$	0.1	5	$\mu A$ (max)
$V_{OS}$	Output Offset Voltage	$V_{IN} = 0V$	5	50	mV (max)
$P_O$	Output Power	THD = 1% (max); $f = 1\text{kHz}$ ; $R_L = 8\Omega$ ;	675	300	mW (min)
THD+N	Total Harmonic Distortion+Noise	$P_O = 400\text{ mWrms}$ ; $A_{VD} = 2$ ; $R_L = 8\Omega$ ; $20\text{Hz} \leq f \leq 20\text{kHz}$ , $BW < 80\text{kHz}$	0.4		%
PSRR	Power Supply Rejection Ratio	$V_{RIPPLE} = 200\text{mV}$ sine p-p			dB
		$f = 217\text{Hz}$ <small>(Note 10)</small>	70		
		$f = 1\text{KHz}$ <small>(Note 10)</small>	67		
		$f = 217\text{Hz}$ <small>(Note 11)</small>	55		
		$f = 1\text{KHz}$ <small>(Note 11)</small>	55		

## Electrical Characteristics (Note 1, Note 2)

The following specifications apply for  $V_{DD} = 3.3V$ , for all available packages, unless otherwise specified.

Limits apply for  $T_A = 25^\circ\text{C}$ .

Symbol	Parameter	Conditions	LM4902		Units (Limits)
			Typical <small>(Note 6)</small>	Limit <small>(Note 7, Note 9)</small>	
$I_{DD}$	Quiescent Power Supply Current	$V_{IN} = 0V, I_O = 0A$ <small>(Note 8)</small>	3	5	mA (max)
$I_{SD}$	Shutdown Current	$V_{PIN1} = GND$	0.1	3	$\mu A$ (max)
$V_{OS}$	Output Offset Voltage	$V_{IN} = 0V$	5	50	mV (max)
$P_O$	Output Power	THD = 1% (max); $f = 1\text{kHz}$ ; $R_L = 8\Omega$ ;	265		mW
THD+N	Total Harmonic Distortion+Noise	$P_O = 250\text{ mWrms}$ ; $A_{VD} = 2$ ; $R_L = 8\Omega$ ; $20\text{Hz} \leq f \leq 20\text{kHz}$ , $BW < 80\text{kHz}$	0.4		%
PSRR	Power Supply Rejection Ratio	$V_{RIPPLE} = 200\text{mV}$ sine p-p			dB
		$f = 217\text{Hz}$ <small>(Note 10)</small>	73		
		$f = 1\text{KHz}$ <small>(Note 10)</small>	70		
		$f = 217\text{Hz}$ <small>(Note 11)</small>	60		
		$f = 1\text{KHz}$ <small>(Note 11)</small>	68		

## Electrical Characteristics *(Note 1, Note 2)*

The following specifications apply for  $V_{DD} = 2.6V$ , for all available packages, unless otherwise specified.

Limits apply for  $T_A = 25^\circ C$ .

Symbol	Parameter	Conditions	LM4902		Units (Limits)
			Typical ( <i>Note 6</i> )	Limit ( <i>Note 7</i> , <i>Note 9</i> )	
$I_{DD}$	Quiescent Power Supply Current	$V_{IN} = 0V, I_O = 0A$ ( <i>Note 8</i> )	2.6	4	mA (max)
$I_{SD}$	Shutdown Current	$V_{PIN1} = V_{DD}$	0.1	2.0	$\mu A$ (max)
$V_{OS}$	Output Offset Voltage	$V_{IN} = 0V$	5		mV
$P_O$	Output Power	THD = 1% (max); $f = 1kHz$ ; $R_L = 8\Omega$	130		mW
THD+N	Total Harmonic Distortion+Noise	$P_O = 100$ mWrms; $A_{VD} = 2$ ; $R_L = 8\Omega$ ; $20Hz \leq f \leq 20kHz$ , BW < 80kHz	0.4		%
PSRR	Power Supply Rejection Ratio	$V_{RIPPLE} = 200mV$ sine p-p			dB
		$f = 217Hz$ ( <i>Note 11</i> )	58		
		$f = 1KHz$ ( <i>Note 11</i> )	63		

**Note 1:** All voltages are measured with respect to the ground pin, unless otherwise specified.

**Note 2:** Absolute Maximum Ratings indicate limits beyond which damage to the device may occur. Operating Ratings indicate conditions for which the device is functional, but do not guarantee specific performance limits. Electrical Characteristics state DC and AC electrical specifications under particular test conditions which guarantee specific performance limits. This assumes that the device is within the Operating Ratings. Specifications are not guaranteed for parameters where no limit is given, however, the typical value is a good indication of device performance.

**Note 3:** The maximum power dissipation must be derated at elevated temperatures and is dictated by  $T_{JMAX}$ ,  $\theta_{JA}$ , and the ambient temperature  $T_A$ . The maximum allowable power dissipation is  $P_{DMAX} = (T_{JMAX} - T_A) / \theta_{JA}$  or the number given in the Absolute Maximum Ratings, whichever is lower. For the LM4902,  $T_{JMAX} = 150^\circ C$ . The typical junction-to-ambient thermal resistance, when board mounted, is  $190^\circ C/W$  for package number MUA08A.

**Note 4:** Human body model, 100pF discharged through a 1.5k $\Omega$  resistor.

**Note 5:** Machine Model, 220pF–240pF discharged through all pins.

**Note 6:** Typicals are measured at  $25^\circ C$  and represent the parametric norm.

**Note 7:** Limits are guaranteed to National's AOQL (Average Outgoing Quality Level).

**Note 8:** The quiescent power supply current depends on the offset voltage when a practical load is connected to the amplifier.

**Note 9:** Datasheet min/max specification limits are guaranteed by design, test, or statistical analysis.

**Note 10:** Unterminated input.

**Note 11:** 10 $\Omega$  terminated input.

## External Components Description

(Figure 1)

Components		Functional Description
1.	$R_i$	Inverting input resistance which sets the closed-loop gain in conjunction with $R_F$ . This resistor also forms a high pass filter with $C_i$ at $f_c = 1/(2\pi R_i C_i)$ .
2.	$C_i$	Input coupling capacitor which blocks the DC voltage at the amplifier's input terminals. Also creates a highpass filter with $R_i$ at $f_c = 1/(2\pi R_i C_i)$ . Refer to the section, <b>Proper Selection of External Components</b> , for an explanation of how to determine the value of $C_i$ .
3.	$R_F$	Feedback resistance which sets the closed-loop gain in conjunction with $R_i$ .
4.	$C_S$	Supply bypass capacitor which provides power supply filtering. Refer to the <b>Power Supply Bypassing</b> section for information concerning proper placement and selection of the supply bypass capacitor.
5.	$C_B$	Bypass pin capacitor which provides half-supply filtering. Refer to the <b>Proper Selection of External Components</b> for information concerning proper placement and selection of $C_B$ .

## Typical Performance Characteristics

THD+N vs Frequency

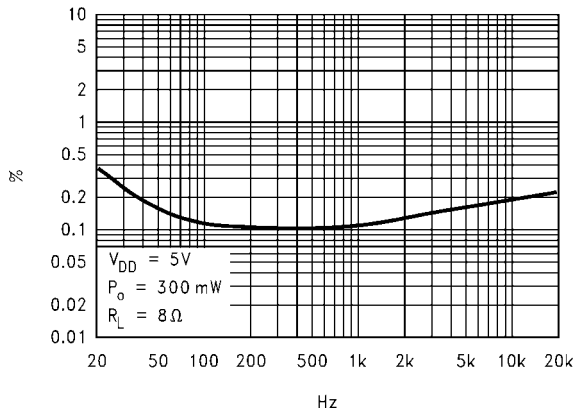

20029830

THD+N vs Frequency

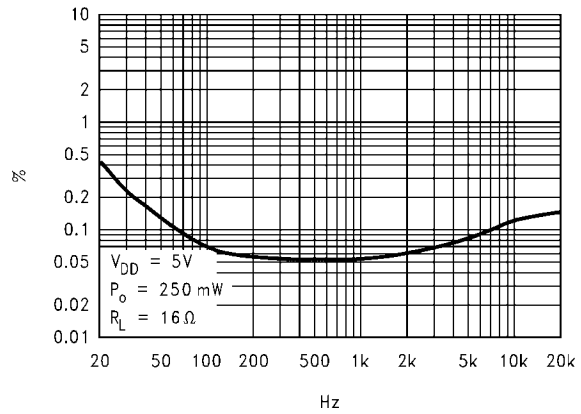

20029831

THD+N vs Frequency

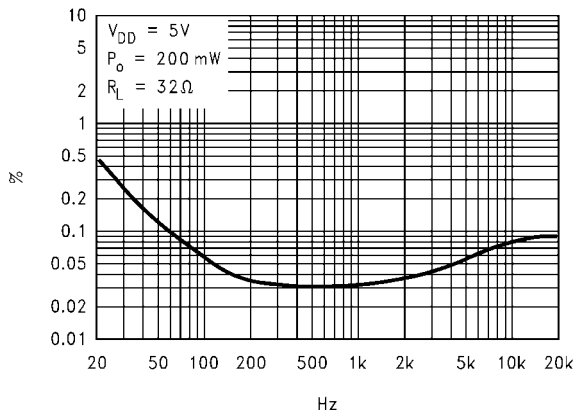

20029832

THD+N vs Frequency

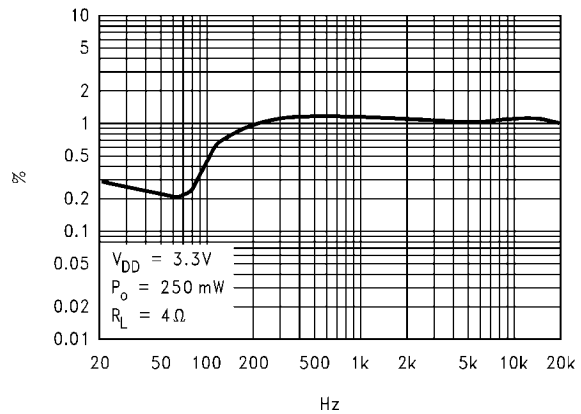

20029833

THD+N vs Frequency

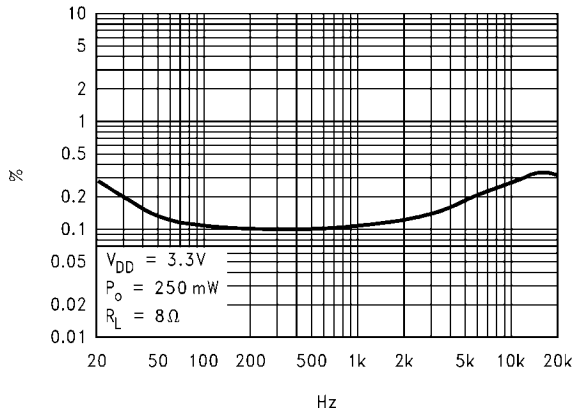

20029834

THD+N vs Frequency

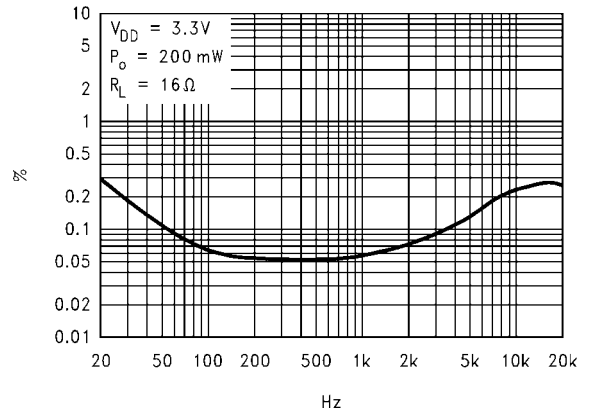

20029835

THD+N vs Frequency

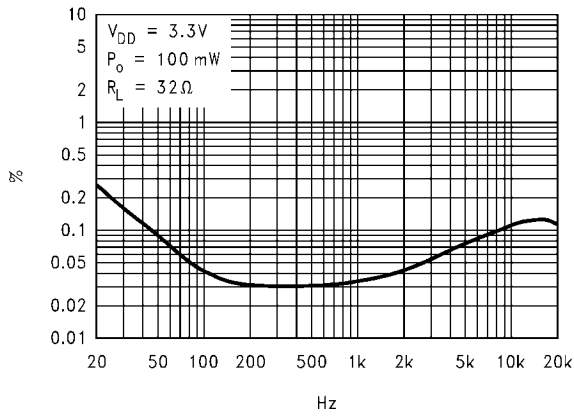

20029836

THD+N vs Frequency

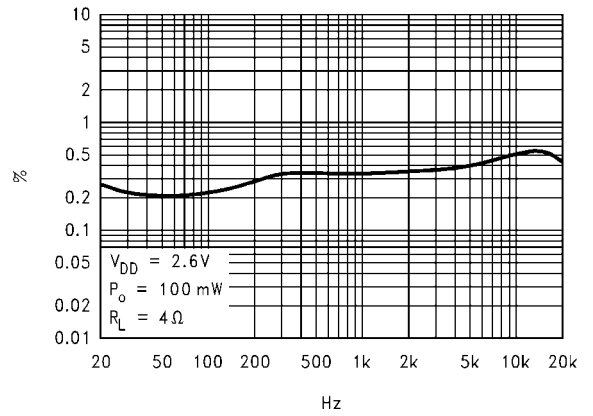

20029837

THD+N vs Frequency

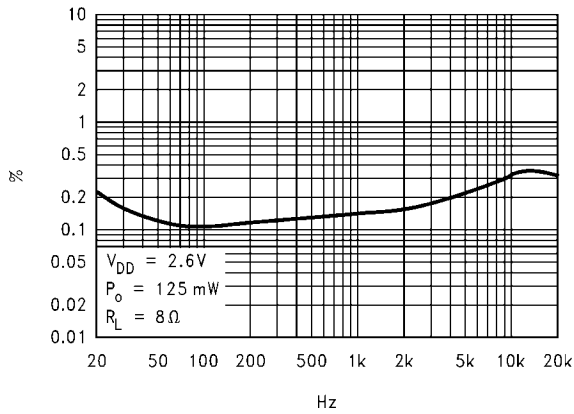

20029838

THD+N vs Frequency

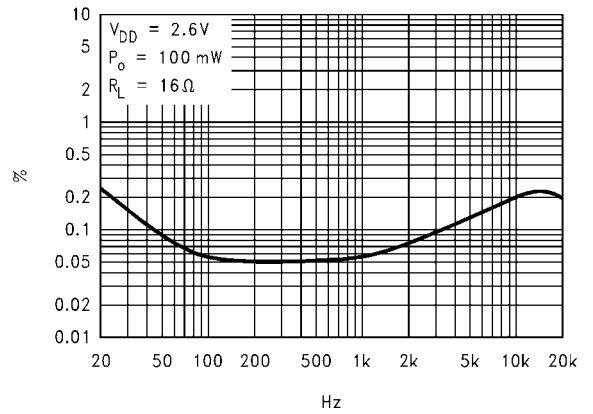

20029839

THD+N vs Frequency

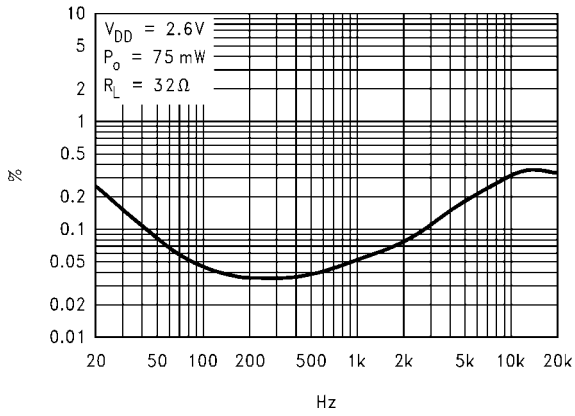

20029840

THD+N vs Output Power

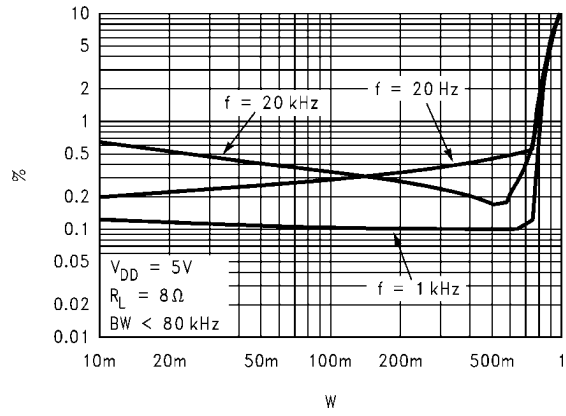

20029841

THD+N vs Output Power

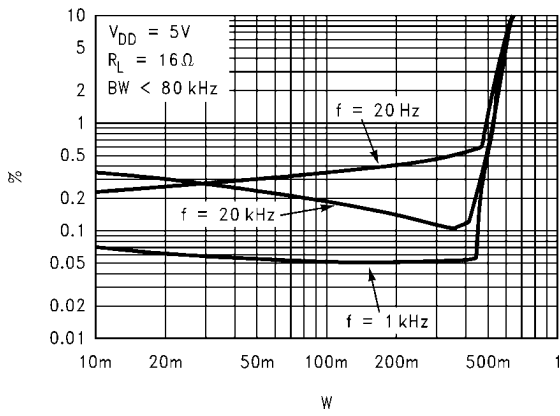

20029842

THD+N vs Output Power

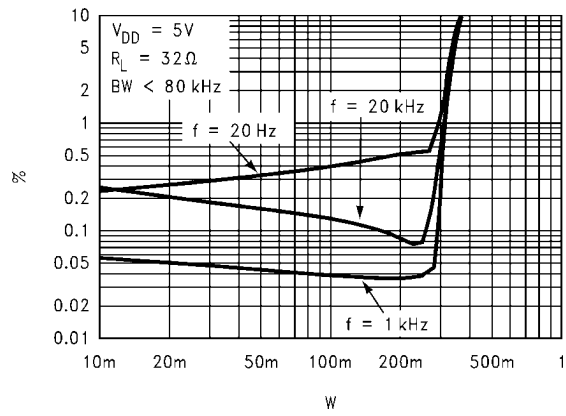

20029843

THD+N vs Output Power

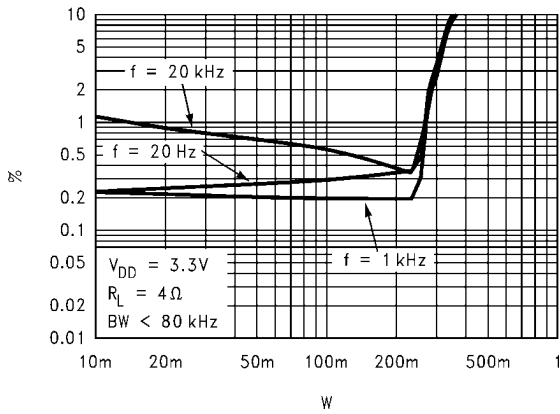

20029844

THD+N vs Output Power

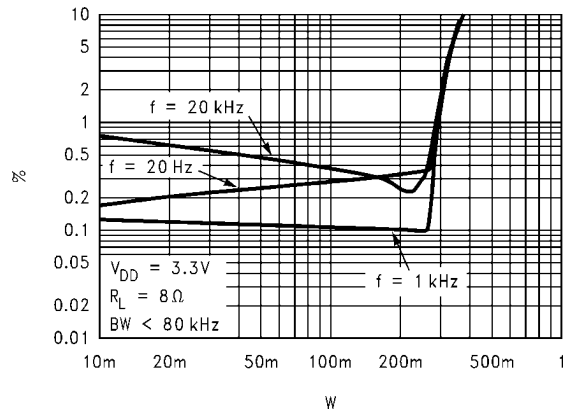

20029845



**THD+N vs Output Power**

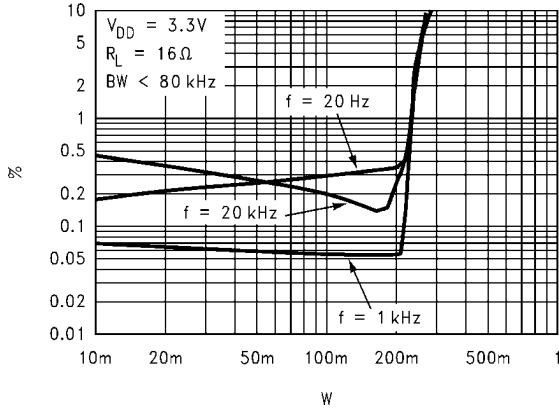

20029846

**THD+N vs Output Power**

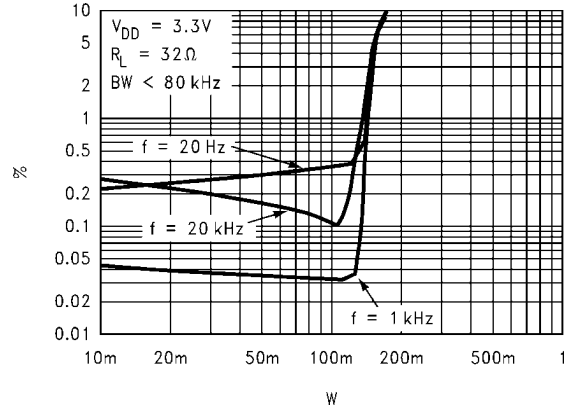

20029847

**THD+N vs Output Power**

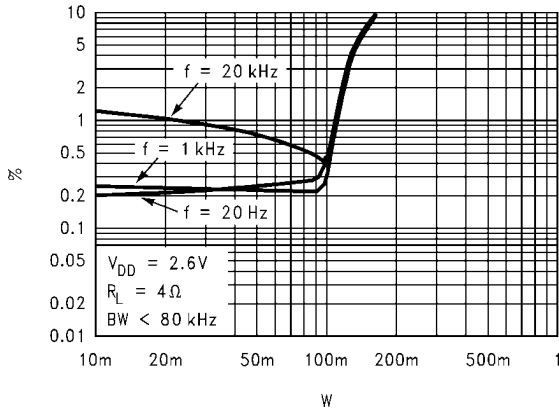

20029848

**THD+N vs Output Power**

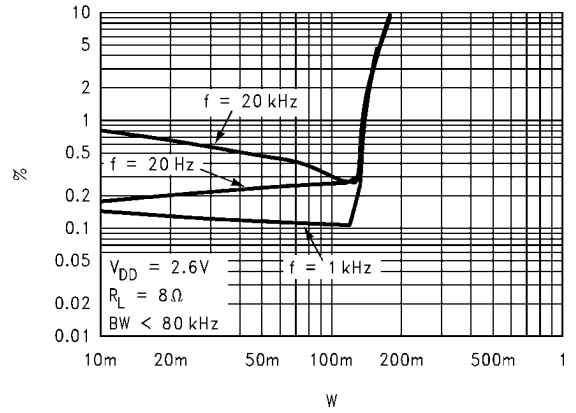

20029849

**THD+N vs Output Power**

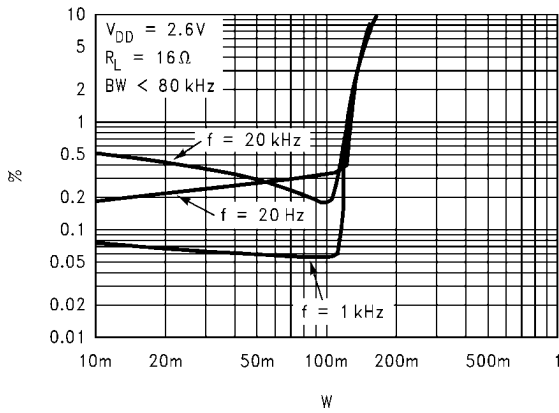

20029850

**THD+N vs Output Power**

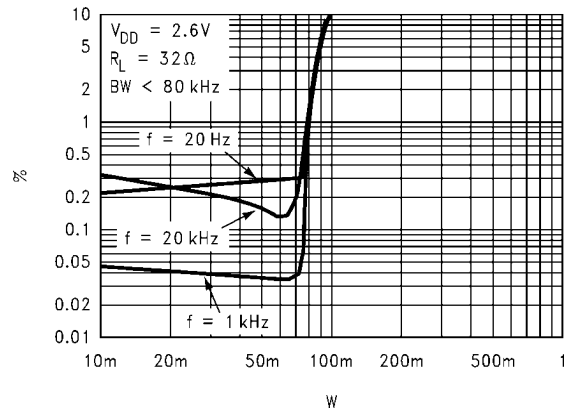

20029851

**Output Power vs Supply Voltage**

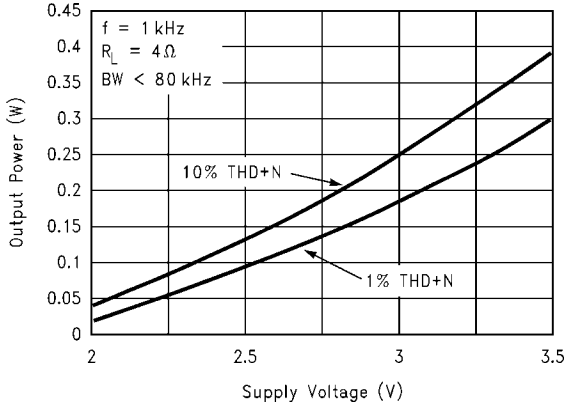

20029852

**Output Power vs Supply Voltage**

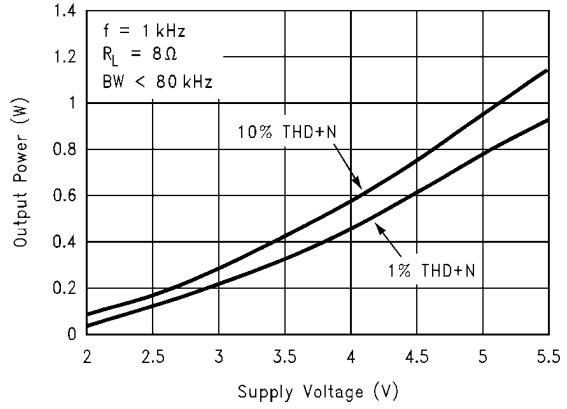

20029853

**Output Power vs Supply Voltage**

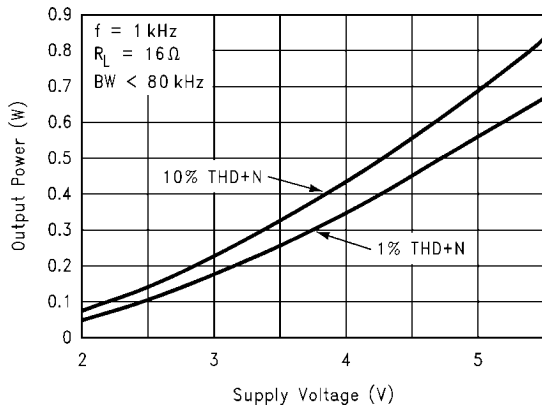

20029854

**Output Power vs Supply Voltage**

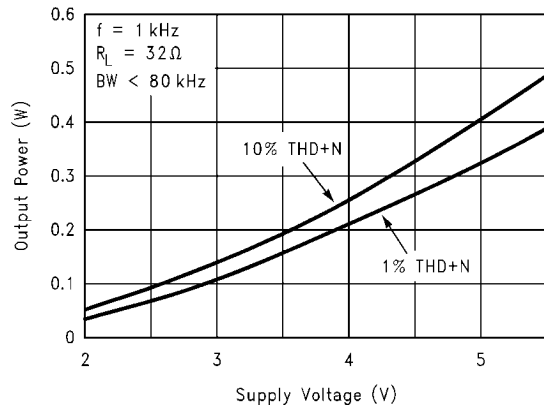

20029855

**Output Power vs Load Resistance**

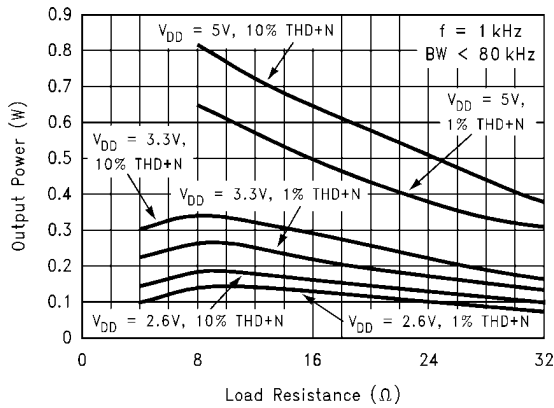

20029856

**Power Dissipation vs Output Power**

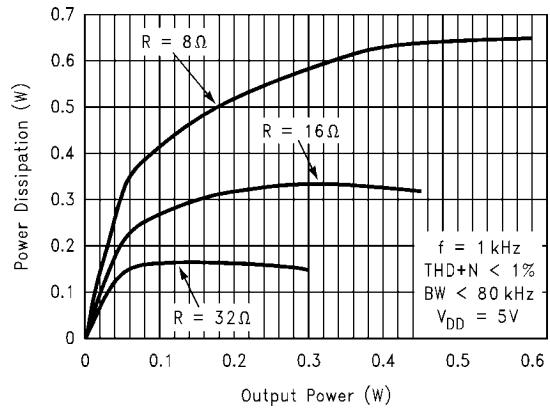

20029857

**Power Dissipation vs Output Power**

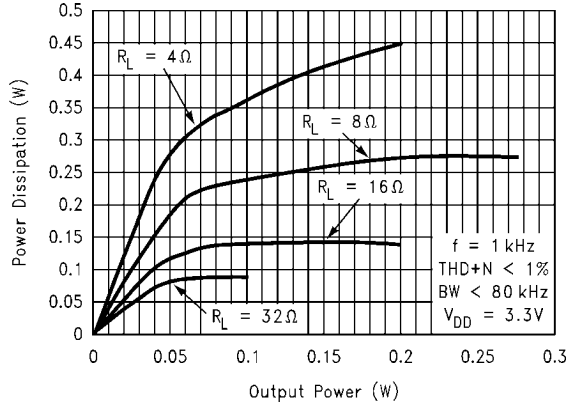

20029858

**Power Dissipation vs Output Power**

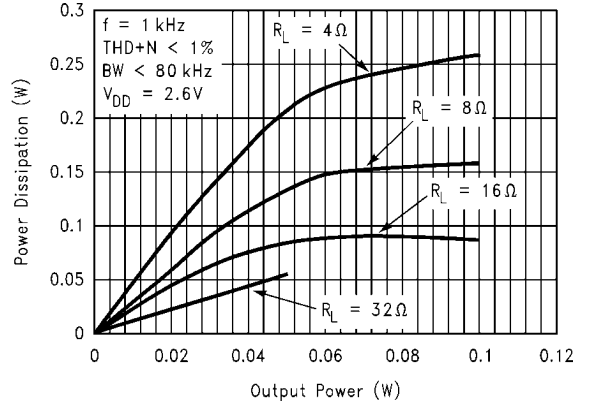

20029859

**Clipping Voltage vs Supply Voltage**

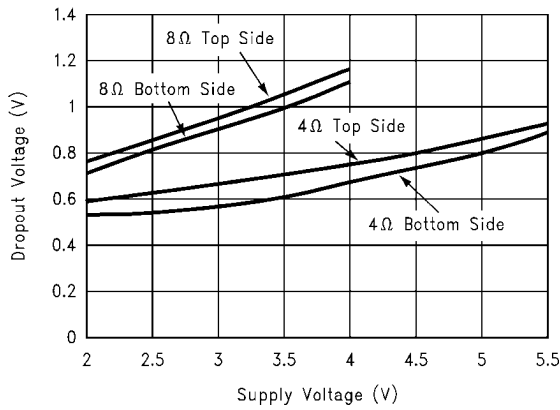

20029860

**Noise Floor**

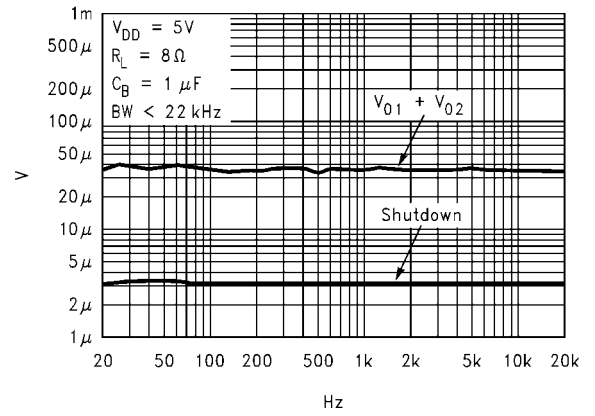

20029861

**Noise Floor**

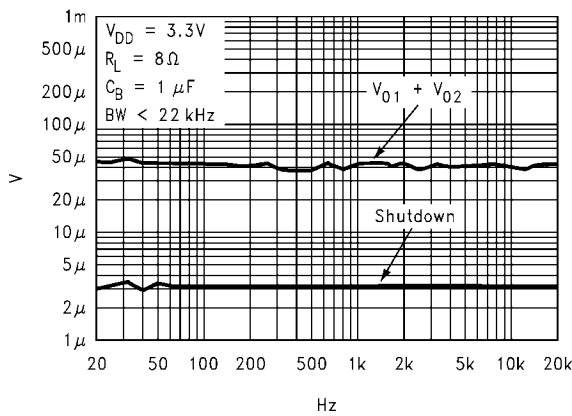

20029862

**Frequency Response vs Input Capacitor Size**

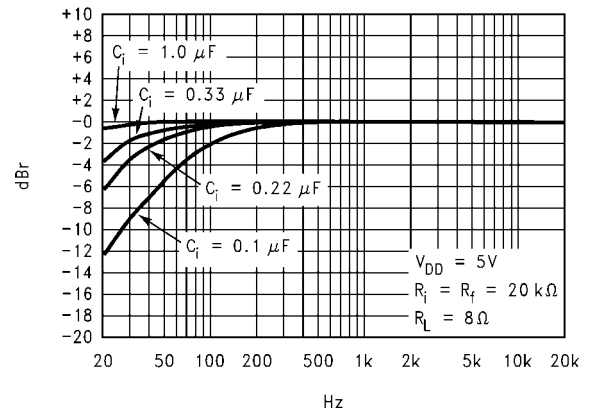

20029871

**Power Supply Rejection Ratio**

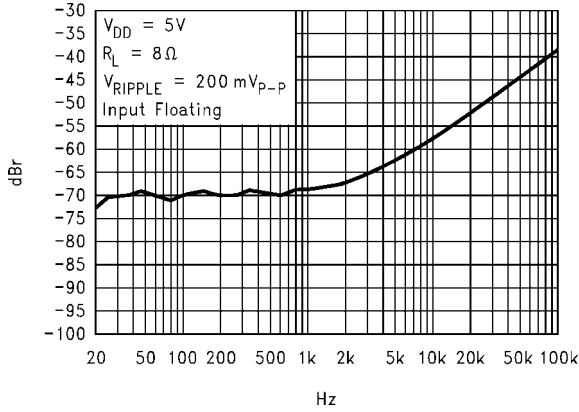

20029863

**Power Supply Rejection Ratio**

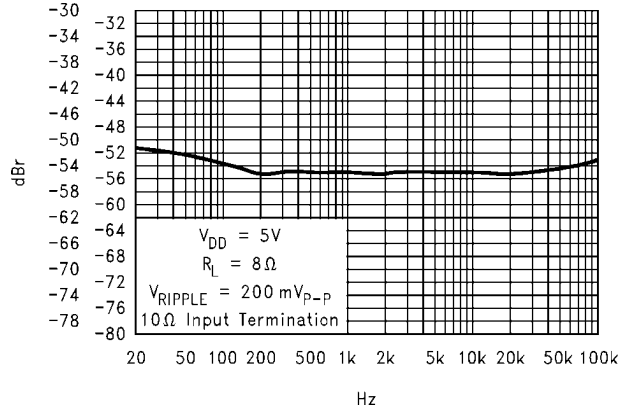

20029864

**Power Supply Rejection Ratio**

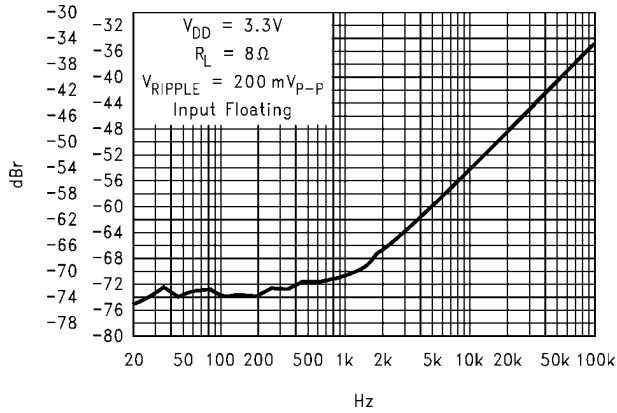

20029865

**Power Supply Rejection Ratio**

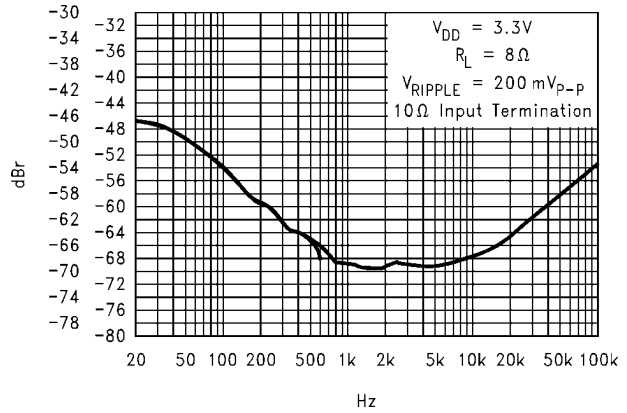

20029866

**Power Supply Rejection Ratio vs Supply Voltage**

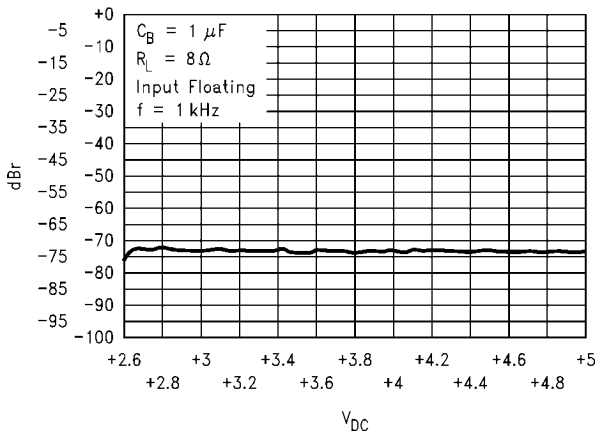

20029867

**Power Supply Rejection Ratio vs Supply Voltage**

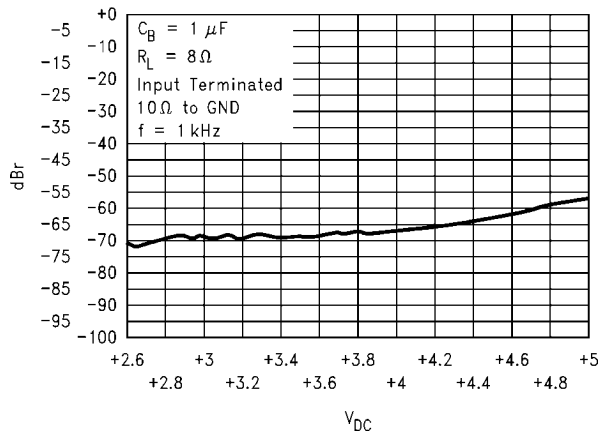

20029868

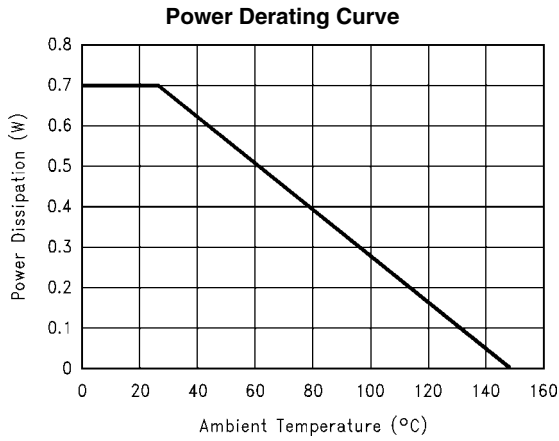

20029873

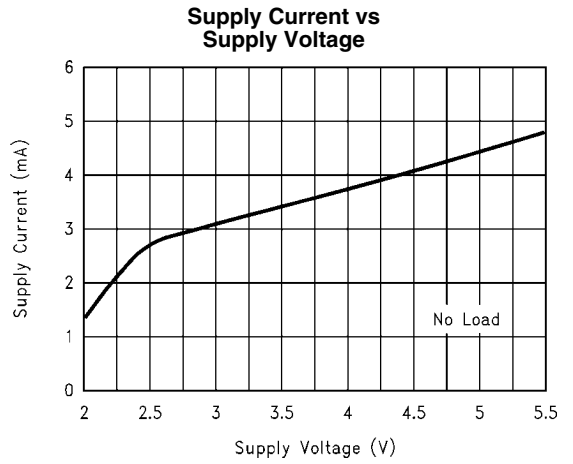

20029870

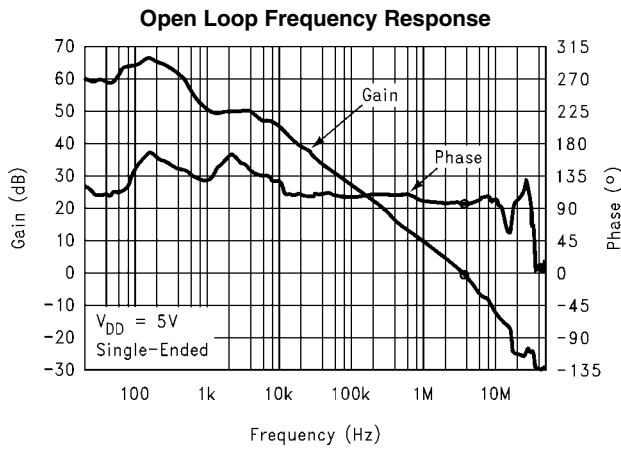

20029872

LM4902LD Power Derating Curve (Note 12)

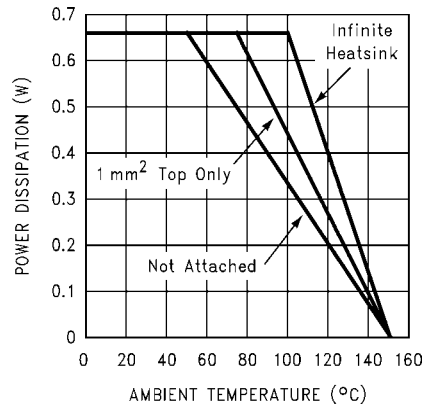

20029876

**Note 12:** This curve shows the LM4902LD's thermal dissipation ability at different ambient temperatures given the exposed-DAP of the part is soldered to a plane of 1oz. Cu with an area given in the label of each curve.

## Application Information

### EXPOSED-DAP PACKAGE PCB MOUNTING CONSIDERATION

The LM4902's exposed-DAP (die-attach paddle) package (LD) provides a low thermal resistance between the die and the PCB to which the part is mounted and soldered. This allows rapid heat from the die to the surrounding PCB copper traces, ground plane, and surrounding air. This allows the LM4902LD to operate at higher output power levels in higher ambient temperatures than the MM package. Failing to optimize thermal design may compromise the high power performance and activate unwanted, though necessary, thermal shutdown protection.

The LD package must have its DAP soldered to a copper pad on the PCB. The DAP's PCB copper pad is connected to a large plane of continuous unbroken copper. This plane forms a thermal mass, heat sink, and radiation area. Place the heat sink area on either outside plane in the case of a two-sided PCB, or on an inner layer of a board with more than two layers. Connect the DAP copper pad to the inner layer or backside copper heat sink area with 2 vias. The via diameter should be 0.012in - 0.013in with a 1.27mm pitch. Ensure efficient thermal conductivity by plating through the vias.

Best thermal performance is achieved with the largest practical heat sink area. The power derating curve in the **Typical Performance Characteristics** shows the maximum power dissipation versus temperature for several different areas of heat sink area. Placing the majority of the heat sink area on another plane is preferred as heat is best dissipated through the bottom of the chip. Further detailed and specific information concerning PCB layout, fabrication, and mounting an LD (LLP) package is available from National Semiconductor's Package Engineering Group under application note AN1187.

### BRIDGE CONFIGURATION EXPLANATION

As shown in *Figure 1*, the LM4902 has two operational amplifiers internally, allowing for a few different amplifier configurations. The first amplifier's gain is externally configurable, while the second amplifier is internally fixed in a unity-gain, inverting configuration. The closed-loop gain of the first amplifier is set by selecting the ratio of  $R_F$  to  $R_i$  while the second amplifier's gain is fixed by the two internal 20k $\Omega$  resistors. *Figure 1* shows that the output of amplifier one serves as the input to amplifier two which results in both amplifiers producing signals identical in magnitude, but out of phase 180°. Consequently, the differential gain for the IC is

$$A_{VD} = 2 \cdot (R_F/R_i)$$

By driving the load differentially through outputs  $V_{o1}$  and  $V_{o2}$ , an amplifier configuration commonly referred to as "bridged mode" is established. Bridged mode operation is different from the classical single-ended amplifier configuration where one side of its load is connected to ground.

A bridge amplifier design has a few distinct advantages over the single-ended configuration, as it provides differential drive to the load, thus doubling output swing for a specified supply voltage. Four times the output power is possible as compared to a single-ended amplifier under the same conditions. This increase in attainable output power assumes that the amplifier is not current limited or clipped. In order to choose an amplifier's closed-loop gain without causing excessive clipping, please refer to the **Audio Power Amplifier Design** section.

A bridge configuration, such as the one used in LM4902, also creates a second advantage over single-ended amplifiers. Since the differential outputs,  $V_{o1}$  and  $V_{o2}$ , are biased at half-supply, no net DC voltage exists across the load. This eliminates the need for an output coupling capacitor which is required in a single supply, single-ended amplifier configuration. If an output coupling capacitor is not used in a single-ended configuration, the half-supply bias across the load would result in both increased internal IC power dissipation as well as permanent loudspeaker damage.

### POWER DISSIPATION

Power dissipation is a major concern when designing a successful amplifier, whether the amplifier is bridged or single-ended. Equation 1 states the maximum power dissipation point for a bridge amplifier operating at a given supply voltage and driving a specified output load.

$$P_{DMAX} = (V_{DD})^2 / (2\pi^2 R_L) \quad \text{Single-Ended (1)}$$

However, a direct consequence of the increased power delivered to the load by a bridge amplifier is an increase in internal power dissipation point for a bridge amplifier operating at the same conditions.

$$P_{DMAX} = 4(V_{DD})^2 / (2\pi^2 R_L) \quad \text{Bridge Mode (2)}$$

Since the LM4902 has two operational amplifiers in one package, the maximum internal power dissipation is 4 times that of a single-ended amplifier. Even with this substantial increase in power dissipation, the LM4902 does not require heatsinking. From Equation 1, assuming a 5V power supply and an 8 $\Omega$  load, the maximum power dissipation point is 625 mW. The maximum power dissipation point obtained from Equation 2 must not be greater than the power dissipation that results from Equation 3:

$$P_{DMAX} = (T_{JMAX} - T_A) / \theta_{JA} \quad (3)$$

For package MUA08A,  $\theta_{JA} = 190^\circ\text{C/W}$ .  $T_{JMAX} = 150^\circ\text{C}$  for the LM4902. Depending on the ambient temperature,  $T_A$ , of the system surroundings, Equation 3 can be used to find the maximum internal power dissipation supported by the IC packaging. If the result of Equation 2 is greater than that of Equation 3, then either the supply voltage must be decreased, the load impedance increased, the ambient temperature reduced, or the  $\theta_{JA}$  reduced with heatsinking. In many cases larger traces near the output,  $V_{DD}$ , and Gnd pins can be used to lower the  $\theta_{JA}$ . The larger areas of copper provide a form of heatsinking allowing a higher power dissipation. For the typical application of a 5V power supply, with an 8 $\Omega$  load, the maximum ambient temperature possible without violating the maximum junction temperature is approximately 30°C provided that device operation is around the maximum power dissipation point. Internal power dissipation is a function of output power. If typical operation is not around the maximum power dissipation point, the ambient temperature can be increased. Refer to the **Typical Performance Characteristics** curves for power dissipation information for lower output powers.

### POWER SUPPLY BYPASSING

As with any power amplifier, proper supply bypassing is critical for low noise performance and high power supply rejection. The capacitor location on both the bypass and power supply pins should be as close to the device as possible. The effect of a larger half supply bypass capacitor is improved PSRR due to increased half-supply stability. Typical applications employ a 5V regulator with 10 $\mu\text{F}$  and a 0.1 $\mu\text{F}$  bypass capacitors which aid in supply stability, but do not eliminate

the need for bypassing the supply nodes of the LM4902. The selection of bypass capacitors, especially  $C_B$ , is thus dependent upon desired PSRR requirements, click and pop performance as explained in the section, **Proper Selection of External Components**, system cost, and size constraints.

### SHUTDOWN FUNCTION

In order to reduce power consumption while not in use, the LM4902 contains a shutdown pin to externally turn off the amplifier's bias circuitry. This shutdown feature turns the amplifier off when a logic low is placed on the shutdown pin. The trigger point between a logic low and logic high level is typically half supply. It is best to switch between ground and supply to provide maximum device performance. By switching the shutdown pin to GND, the LM4902 supply current draw will be minimized in idle mode. While the device will be disabled with shutdown pin voltages greater than GND, the idle current may be greater than the typical value of 0.1 $\mu$ A. In either case, the shutdown pin should be tied to a definite voltage to avoid unwanted state changes.

In many applications, a microcontroller or microprocessor output is used to control the shutdown circuitry which provides a quick, smooth transition into shutdown. Another solution is to use a single-pole, single-throw switch in conjunction with an external pull-up resistor. When the switch is closed, the shutdown pin is connected to ground and disables the amplifier. If the switch is open, then the external pull-up resistor will enable the LM4902. This scheme guarantees that the shutdown pin will not float, thus preventing unwanted state changes.

### PROPER SELECTION OF EXTERNAL COMPONENTS

Proper selection of external components in applications using integrated power amplifiers is critical to optimize device and system performance. While the LM4902 is tolerant to a variety of external component combinations, consideration to component values must be used to maximize overall system quality.

The LM4902 is unity-gain stable, giving a designer maximum system flexibility. The LM4902 should be used in low gain configurations to minimize THD+N values, and maximize the signal to noise ratio. Low gain configurations require large input signals to obtain a given output power. Input signals equal to or greater than 1 Vrms are available from sources such as audio codecs. Please refer to the section, **Audio Power Amplifier Design**, for a more complete explanation of proper gain selection.

Besides gain, one of the major considerations is the closed-loop bandwidth of the amplifier. To a large extent, the bandwidth is dictated by the choice of external components shown in [Figure 1](#). The input coupling capacitor,  $C_i$ , forms a first order high pass filter which limits low frequency response. This value should be chosen based on needed frequency response for a few distinct reasons.

#### Selection of Input Capacitor Size

Large input capacitors are both expensive and space hungry for portable designs. Clearly, a certain sized capacitor is needed to couple in low frequencies without severe attenuation. But in many cases the speakers used in portable systems, whether internal or external, have little ability to reproduce signals below 150Hz. In this case using a large input capacitor may not increase system performance.

In addition to system cost and size, click and pop performance is effected by the size of the input coupling capacitor,  $C_i$ . A larger input coupling capacitor requires more charge to reach

its quiescent DC voltage (nominally  $\frac{1}{2} V_{DD}$ ). This charge comes from the output via the feedback and is apt to create pops upon device enable. Thus, by minimizing the capacitor size based on necessary low frequency response, turn-on pops can be minimized.

Besides minimizing the input capacitor size, careful consideration should be paid to the bypass capacitor value. Bypass capacitor,  $C_B$ , is the most critical component to minimize turn-on pops since it determines how fast the LM4902 turns on. The slower the LM4902's outputs ramp to their quiescent DC voltage (nominally  $\frac{1}{2} V_{DD}$ ), the smaller the turn-on pop. Choosing  $C_B$  equal to 1.0  $\mu$ F along with a small value of  $C_i$  (in the range of 0.1 $\mu$ F to 0.39 $\mu$ F), should produce a clickless and popless shutdown function. While the device will function properly, (no oscillations or motorboating), with  $C_B$  equal to 0.1 $\mu$ F, the device will be much more susceptible to turn-on clicks and pops. Thus, a value of  $C_B$  equal to 1.0 $\mu$ F or larger is recommended in all but the most cost sensitive designs.

### AUDIO POWER AMPLIFIER DESIGN

#### Design a 300 mW/8 $\Omega$ Audio Amplifier

Given:

Power Output	300mWrms
Load Impedance	8 $\Omega$
Input Level	1Vrms
Input Impedance	20k $\Omega$
Bandwidth	100Hz–20 kHz $\pm$ 0.25dB

A designer must first determine the minimum supply rail to obtain the specified output power. By extrapolating from the Output Power vs Supply Voltage graphs in the **Typical Performance Characteristics** section, the supply rail can be easily found. A second way to determine the minimum supply rail is to calculate the required  $V_{\text{opeak}}$  using Equation 4 and add the dropout voltage. Using this method, the minimum supply voltage would be  $(V_{\text{opeak}} + (2 \cdot V_{\text{OD}}))$ , where  $V_{\text{OD}}$  is extrapolated from the Dropout Voltage vs Supply Voltage curve in the **Typical Performance Characteristics** section.

$$V_{\text{opeak}} = \sqrt{(2R_L P_O)} \quad (4)$$

Using the Output Power vs Supply Voltage graph for an 8 $\Omega$  load, the minimum supply rail is 3.5V. But since 5V is a standard supply voltage in most applications, it is chosen for the supply rail. Extra supply voltage creates headroom that allows the LM4902 to reproduce peaks in excess of 700 mW without producing audible distortion. At this time, the designer must make sure that the power supply choice along with the output impedance does not violate the conditions explained in the **Power Dissipation** section.

Once the power dissipation equations have been addressed, the required differential gain can be determined from Equation 5.

$$A_{VD} \geq \sqrt{(P_O R_L)} / (V_{IN}) = V_{\text{orms}} / V_{\text{inrms}} \quad (5)$$

$$R_F / R_i = A_{VD} / 2 \quad (6)$$

From Equation 5, the minimum  $A_{VD}$  is 1.55; use  $A_{VD} = 2$ . Since the desired input impedance was 20 k $\Omega$ , and with a  $A_{VD}$  of 2, a ratio of 1:1 of  $R_F$  to  $R_i$  results in an allocation of

$R_i = R_F = 20 \text{ k}\Omega$ . The final design step is to address the bandwidth requirements which must be stated as a pair of  $-3 \text{ dB}$  frequency points. Five times away from a pole gives  $0.17 \text{ dB}$  down from passband response which is better than the required  $\pm 0.25 \text{ dB}$  specified.

$$f_L = 100\text{Hz}/5 = 20\text{Hz}$$

$$f_H = 20\text{kHz} \times 5 = 100\text{kHz}$$

As stated in the **External Components** section,  $R_i$  in conjunction with  $C_i$  create a highpass filter.

$$C_i \geq \frac{1}{2\pi R_i f_c}$$

$$C_i \geq 1/(2\pi * 20 \text{ k}\Omega * 20 \text{ Hz}) = 0.397\mu\text{F}; \text{ use } 0.39\mu\text{F}$$

The high frequency pole is determined by the product of the desired high frequency pole,  $f_H$ , and the differential gain,  $A_{VD}$ . With a  $A_{VD} = 2$  and  $f_H = 100\text{kHz}$ , the resulting  $\text{GBWP} = 100\text{kHz}$  which is much smaller than the LM4902  $\text{GBWP} = 25\text{MHz}$ . This figure displays that if a designer has a need to design an amplifier with a higher differential gain, the LM4902 can still be used without running into bandwidth problems.

#### DIFFERENTIAL AMPLIFIER CONFIGURATION FOR LM4902

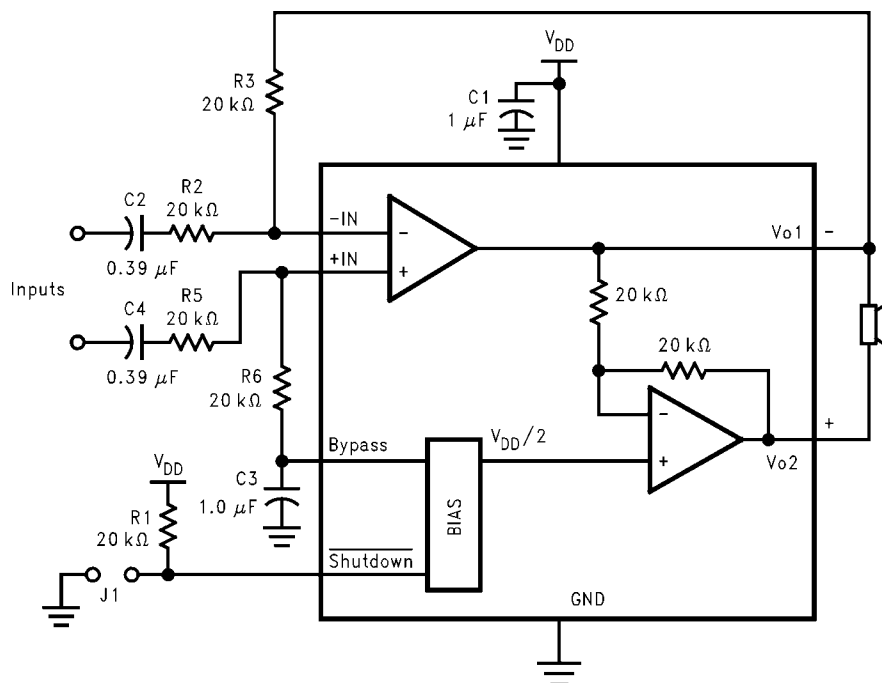

20029874



**Physical Dimensions** inches (millimeters) unless otherwise noted

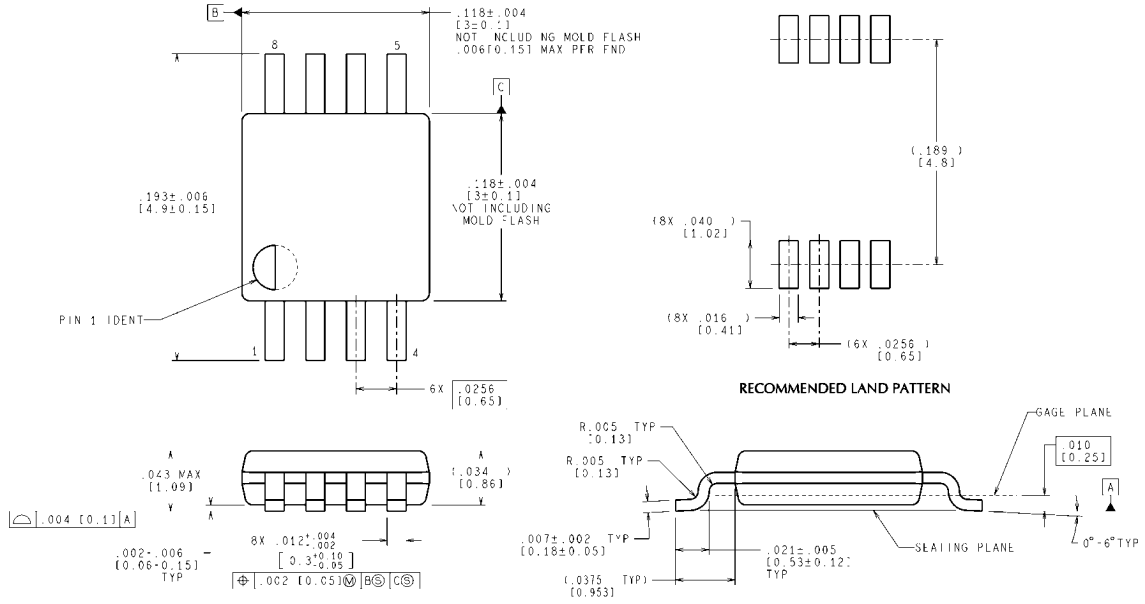

**8-Lead (0.118 Wide) Molded Mini Small Outline Package**  
**Order Number LM4902MM**  
**NS Package Number MUA08A**

MUA08A (Rev F)

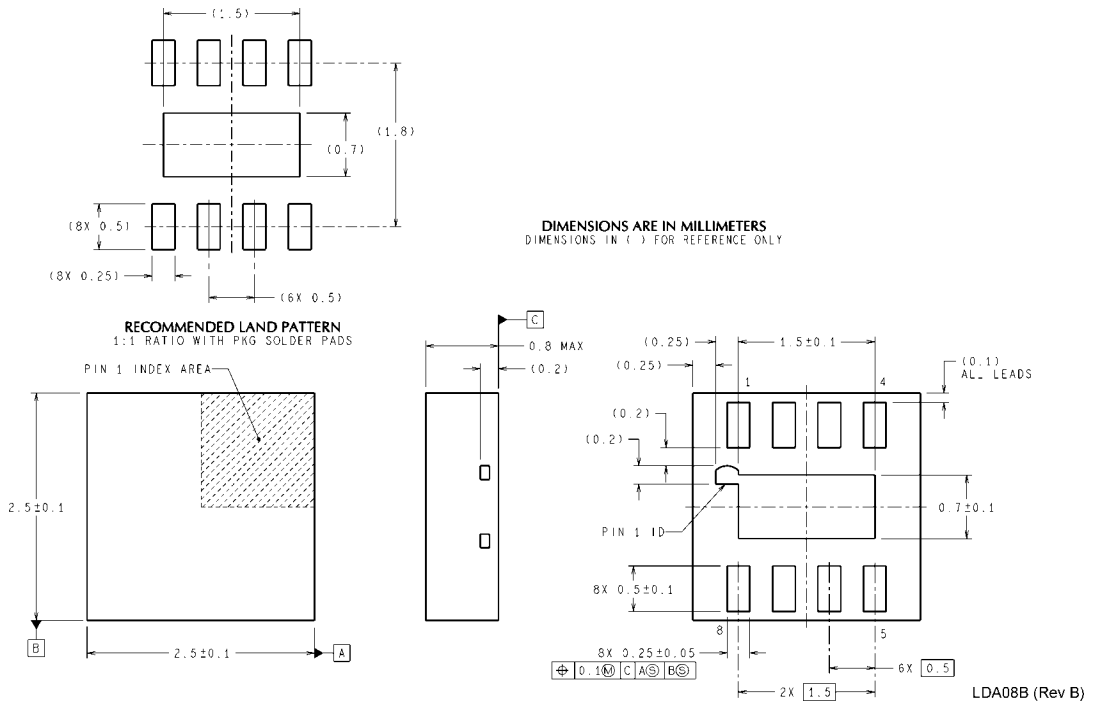

# Notes

LM4902

## Notes

For more National Semiconductor product information and proven design tools, visit the following Web sites at:  
[www.national.com](http://www.national.com)

Products		Design Support	
Amplifiers	<a href="http://www.national.com/amplifiers">www.national.com/amplifiers</a>	WEBENCH® Tools	<a href="http://www.national.com/webench">www.national.com/webench</a>
Audio	<a href="http://www.national.com/audio">www.national.com/audio</a>	App Notes	<a href="http://www.national.com/appnotes">www.national.com/appnotes</a>
Clock and Timing	<a href="http://www.national.com/timing">www.national.com/timing</a>	Reference Designs	<a href="http://www.national.com/refdesigns">www.national.com/refdesigns</a>
Data Converters	<a href="http://www.national.com/adc">www.national.com/adc</a>	Samples	<a href="http://www.national.com/samples">www.national.com/samples</a>
Interface	<a href="http://www.national.com/interface">www.national.com/interface</a>	Eval Boards	<a href="http://www.national.com/evalboards">www.national.com/evalboards</a>
LVDS	<a href="http://www.national.com/lvds">www.national.com/lvds</a>	Packaging	<a href="http://www.national.com/packaging">www.national.com/packaging</a>
Power Management	<a href="http://www.national.com/power">www.national.com/power</a>	Green Compliance	<a href="http://www.national.com/quality/green">www.national.com/quality/green</a>
Switching Regulators	<a href="http://www.national.com/switchers">www.national.com/switchers</a>	Distributors	<a href="http://www.national.com/contacts">www.national.com/contacts</a>
LDOs	<a href="http://www.national.com/ldo">www.national.com/ldo</a>	Quality and Reliability	<a href="http://www.national.com/quality">www.national.com/quality</a>
LED Lighting	<a href="http://www.national.com/led">www.national.com/led</a>	Feedback/Support	<a href="http://www.national.com/feedback">www.national.com/feedback</a>
Voltage References	<a href="http://www.national.com/vref">www.national.com/vref</a>	Design Made Easy	<a href="http://www.national.com/easy">www.national.com/easy</a>
PowerWise® Solutions	<a href="http://www.national.com/powerwise">www.national.com/powerwise</a>	Applications & Markets	<a href="http://www.national.com/solutions">www.national.com/solutions</a>
Serial Digital Interface (SDI)	<a href="http://www.national.com/sdi">www.national.com/sdi</a>	Mil/Aero	<a href="http://www.national.com/milaero">www.national.com/milaero</a>
Temperature Sensors	<a href="http://www.national.com/tempensors">www.national.com/tempensors</a>	SolarMagic™	<a href="http://www.national.com/solarmagic">www.national.com/solarmagic</a>
PLL/VCO	<a href="http://www.national.com/wireless">www.national.com/wireless</a>	PowerWise® Design University	<a href="http://www.national.com/training">www.national.com/training</a>

THE CONTENTS OF THIS DOCUMENT ARE PROVIDED IN CONNECTION WITH NATIONAL SEMICONDUCTOR CORPORATION ("NATIONAL") PRODUCTS. NATIONAL MAKES NO REPRESENTATIONS OR WARRANTIES WITH RESPECT TO THE ACCURACY OR COMPLETENESS OF THE CONTENTS OF THIS PUBLICATION AND RESERVES THE RIGHT TO MAKE CHANGES TO SPECIFICATIONS AND PRODUCT DESCRIPTIONS AT ANY TIME WITHOUT NOTICE. NO LICENSE, WHETHER EXPRESS, IMPLIED, ARISING BY ESTOPPEL OR OTHERWISE, TO ANY INTELLECTUAL PROPERTY RIGHTS IS GRANTED BY THIS DOCUMENT.

TESTING AND OTHER QUALITY CONTROLS ARE USED TO THE EXTENT NATIONAL DEEMS NECESSARY TO SUPPORT NATIONAL'S PRODUCT WARRANTY. EXCEPT WHERE MANDATED BY GOVERNMENT REQUIREMENTS, TESTING OF ALL PARAMETERS OF EACH PRODUCT IS NOT NECESSARILY PERFORMED. NATIONAL ASSUMES NO LIABILITY FOR APPLICATIONS ASSISTANCE OR BUYER PRODUCT DESIGN. BUYERS ARE RESPONSIBLE FOR THEIR PRODUCTS AND APPLICATIONS USING NATIONAL COMPONENTS. PRIOR TO USING OR DISTRIBUTING ANY PRODUCTS THAT INCLUDE NATIONAL COMPONENTS, BUYERS SHOULD PROVIDE ADEQUATE DESIGN, TESTING AND OPERATING SAFEGUARDS.

EXCEPT AS PROVIDED IN NATIONAL'S TERMS AND CONDITIONS OF SALE FOR SUCH PRODUCTS, NATIONAL ASSUMES NO LIABILITY WHATSOEVER, AND NATIONAL DISCLAIMS ANY EXPRESS OR IMPLIED WARRANTY RELATING TO THE SALE AND/OR USE OF NATIONAL PRODUCTS INCLUDING LIABILITY OR WARRANTIES RELATING TO FITNESS FOR A PARTICULAR PURPOSE, MERCHANTABILITY, OR INFRINGEMENT OF ANY PATENT, COPYRIGHT OR OTHER INTELLECTUAL PROPERTY RIGHT.

#### LIFE SUPPORT POLICY

**NATIONAL'S PRODUCTS ARE NOT AUTHORIZED FOR USE AS CRITICAL COMPONENTS IN LIFE SUPPORT DEVICES OR SYSTEMS WITHOUT THE EXPRESS PRIOR WRITTEN APPROVAL OF THE CHIEF EXECUTIVE OFFICER AND GENERAL COUNSEL OF NATIONAL SEMICONDUCTOR CORPORATION.** As used herein:

Life support devices or systems are devices which (a) are intended for surgical implant into the body, or (b) support or sustain life and whose failure to perform when properly used in accordance with instructions for use provided in the labeling can be reasonably expected to result in a significant injury to the user. A critical component is any component in a life support device or system whose failure to perform can be reasonably expected to cause the failure of the life support device or system or to affect its safety or effectiveness.

National Semiconductor and the National Semiconductor logo are registered trademarks of National Semiconductor Corporation. All other brand or product names may be trademarks or registered trademarks of their respective holders.

Copyright© 2011 National Semiconductor Corporation

For the most current product information visit us at [www.national.com](http://www.national.com)



**National Semiconductor**  
**Americas Technical**  
**Support Center**  
 Email: [support@nsc.com](mailto:support@nsc.com)  
 Tel: 1-800-272-9959

**National Semiconductor Europe**  
**Technical Support Center**  
 Email: [europe.support@nsc.com](mailto:europe.support@nsc.com)

**National Semiconductor Asia**  
**Pacific Technical Support Center**  
 Email: [ap.support@nsc.com](mailto:ap.support@nsc.com)

**National Semiconductor Japan**  
**Technical Support Center**  
 Email: [jpn.feedback@nsc.com](mailto:jpn.feedback@nsc.com)