

# RF Power Field Effect Transistors

## N-Channel Enhancement-Mode Lateral MOSFETs

Designed for CDMA base station applications with frequencies from 1880 to 2025 MHz. Can be used in Class AB and Class C for all typical cellular base station modulation formats.

- Typical Doherty Single-Carrier W-CDMA Performance:  $V_{DD} = 28$  Volts,  $I_{DQA} = 550$  mA,  $V_{GSB} = 1.6$  Vdc,  $P_{out} = 37$  Watts Avg., IQ Magnitude Clipping, Channel Bandwidth = 3.84 MHz, Input Signal PAR = 9.9 dB @ 0.01% Probability on CCDF.

Frequency	$G_{ps}$ (dB)	$\eta_D$ (%)	Output PAR (dB)	ACPR (dBc)
1880 MHz	16.5	44.8	7.0	-29.8
1900 MHz	16.6	45.3	6.9	-30.1
1920 MHz	16.5	45.8	6.9	-30.6

- Capable of Handling 10:1 VSWR, @ 32 Vdc, 1900 MHz, 150 Watts CW Output Power (3 dB Input Overdrive from Rated  $P_{out}$ )
- Typical  $P_{out}$  @ 3 dB Compression Point  $\approx$  160 Watts CW

### 2025 MHz

- Typical Doherty Single-Carrier W-CDMA Performance:  $V_{DD} = 28$  Volts,  $I_{DQA} = 550$  mA,  $V_{GSB} = 1.6$  Vdc,  $P_{out} = 37$  Watts Avg., IQ Magnitude Clipping, Channel Bandwidth = 3.84 MHz, Input Signal PAR = 9.9 dB @ 0.01% Probability on CCDF.

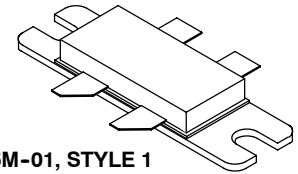
Frequency	$G_{ps}$ (dB)	$\eta_D$ (%)	Output PAR (dB)	ACPR (dBc)
2025 MHz	15.3	44.0	6.8	-30.0

### Features

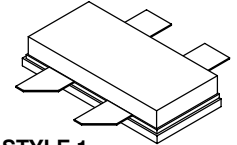
- Production Tested in a Symmetrical Doherty Configuration
- 100% PAR Tested for Guaranteed Output Power Capability
- Characterized with Large-Signal Load-Pull Parameters and Common Source S-Parameters
- Internally Matched for Ease of Use
- Integrated ESD Protection
- Greater Negative Gate-Source Voltage Range for Improved Class C Operation
- Designed for Digital Predistortion Error Correction Systems
- RoHS Compliant
- NI-780-4 in Tape and Reel. R3 Suffix = 250 Units per 56 mm, 13 inch Reel.  
NI-780S-4 in Tape and Reel. R3 Suffix = 250 Units per 32 mm, 13 inch Reel.

**MRF8P20160HR3**  
**MRF8P20160HSR3**

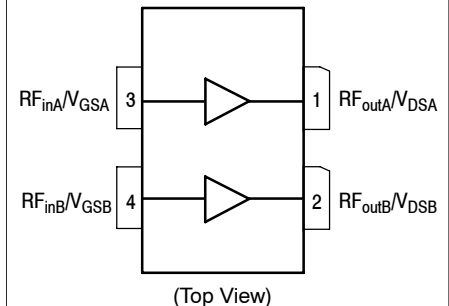
**1880-2025 MHz, 37 W AVG., 28 V**  
**SINGLE W-CDMA**  
**LATERAL N-CHANNEL**  
**RF POWER MOSFETs**



**CASE 465M-01, STYLE 1**  
**NI-780-4**  
**MRF8P20160HR3**



**CASE 465H-02, STYLE 1**  
**NI-780S-4**  
**MRF8P20160HSR3**



**Figure 1. Pin Connections**

**Table 1. Maximum Ratings**

Rating	Symbol	Value	Unit
Drain-Source Voltage	$V_{DSS}$	-0.5, +65	Vdc
Gate-Source Voltage	$V_{GS}$	-6.0, +10	Vdc
Operating Voltage	$V_{DD}$	32, +0	Vdc
Storage Temperature Range	$T_{stg}$	-65 to +150	$^{\circ}C$
Case Operating Temperature	$T_C$	150	$^{\circ}C$
Operating Junction Temperature (1,2)	$T_J$	225	$^{\circ}C$

1. Continuous use at maximum temperature will affect MTTF.

2. MTTF calculator available at <http://www.freescale.com/rf>. Select Software & Tools/Development Tools/Calculators to access MTTF calculators by product.

**Table 2. Thermal Characteristics**

Characteristic	Symbol	Value (1,2)	Unit
Thermal Resistance, Junction to Case Case Temperature 81°C, 37 W CW, 28 Vdc, I <sub>DQA</sub> = 550 mA, V <sub>G<sub>SB</sub></sub> = 1.3 Vdc, 1900 MHz	R <sub>θJC</sub>	0.75	°C/W

**Table 3. ESD Protection Characteristics**

Test Methodology	Class
Human Body Model (per JESD22-A114)	2 (Minimum)
Machine Model (per EIA/JESD22-A115)	A (Minimum)
Charge Device Model (per JESD22-C101)	IV (Minimum)

**Table 4. Electrical Characteristics** (T<sub>A</sub> = 25°C unless otherwise noted)

Characteristic	Symbol	Min	Typ	Max	Unit
----------------	--------	-----	-----	-----	------

**Off Characteristics** <sup>(3)</sup>

Zero Gate Voltage Drain Leakage Current (V <sub>DS</sub> = 65 Vdc, V <sub>GS</sub> = 0 Vdc)	I <sub>DSS</sub>	—	—	10	μAdc
Zero Gate Voltage Drain Leakage Current (V <sub>DS</sub> = 28 Vdc, V <sub>GS</sub> = 0 Vdc)	I <sub>DSS</sub>	—	—	1	μAdc
Gate-Source Leakage Current (V <sub>GS</sub> = 5 Vdc, V <sub>DS</sub> = 0 Vdc)	I <sub>GSS</sub>	—	—	1	μAdc

**On Characteristics** <sup>(3)</sup>

Gate Threshold Voltage (V <sub>DS</sub> = 10 Vdc, I <sub>D</sub> = 116 μAdc)	V <sub>GS(th)</sub>	1.2	1.8	2.7	Vdc
Gate Quiescent Voltage (V <sub>DD</sub> = 28 Vdc, I <sub>DA</sub> = 550 mAdc, Measured in Functional Test)	V <sub>GS(Q)</sub>	1.9	2.7	3.4	Vdc
Drain-Source On-Voltage (V <sub>GS</sub> = 10 Vdc, I <sub>D</sub> = 1.5 Adc)	V <sub>DS(on)</sub>	0.1	0.27	0.5	Vdc

**Functional Tests** <sup>(4,5)</sup> (In Freescale Doherty Test Fixture, 50 ohm system) V<sub>DD</sub> = 28 Vdc, I<sub>DQA</sub> = 550 mA, V<sub>G<sub>SB</sub></sub> = 1.6 Vdc, P<sub>out</sub> = 37 W Avg., f = 1920 MHz, Single-Carrier W-CDMA, IQ Magnitude Clipping, Input Signal PAR = 9.9 dB @ 0.01% Probability on CCDF. ACPR measured in 3.84 MHz Channel Bandwidth @ ±5 MHz Offset.

Power Gain	G <sub>ps</sub>	15.5	16.5	18.5	dB
Drain Efficiency	η <sub>D</sub>	43.5	45.8	—	%
Output Peak-to-Average Ratio @ 0.01% Probability on CCDF	PAR	6.4	6.9	—	dB
Adjacent Channel Power Ratio	ACPR	—	-30.6	-28.5	dBc

**Typical Broadband Performance** <sup>(5)</sup> (In Freescale Doherty Test Fixture, 50 ohm system) V<sub>DD</sub> = 28 Vdc, I<sub>DQA</sub> = 550 mA, V<sub>G<sub>SB</sub></sub> = 1.6 Vdc, P<sub>out</sub> = 37 W Avg., f = 1920 MHz, Single-Carrier W-CDMA, IQ Magnitude Clipping, Input Signal PAR = 9.9 dB @ 0.01% Probability on CCDF. ACPR measured in 3.84 MHz Channel Bandwidth @ ±5 MHz Offset.

Frequency	G <sub>ps</sub> (dB)	η <sub>D</sub> (%)	Output PAR (dB)	ACPR (dBc)
1880 MHz	16.5	44.8	7.0	-29.8
1900 MHz	16.6	45.3	6.9	-30.1
1920 MHz	16.5	45.8	6.9	-30.6

1. MTTF calculator available at <http://www.freescale.com/rf>. Select Software & Tools/Development Tools/Calculators to access MTTF calculators by product.
2. Refer to AN1955, *Thermal Measurement Methodology of RF Power Amplifiers*. Go to <http://www.freescale.com/rf>. Select Documentation/Application Notes - AN1955.
3. Each side of device measured separately.
4. Part internally matched both on input and output.
5. Measurement made with device in a Symmetrical Doherty configuration.

(continued)

**Table 4. Electrical Characteristics** ( $T_A = 25^\circ\text{C}$  unless otherwise noted) (continued)

Characteristic	Symbol	Min	Typ	Max	Unit
<b>Typical Performance</b> <sup>(1)</sup> (In Freescale Doherty Test Fixture, 50 ohm system) $V_{DD} = 28\text{ Vdc}$ , $I_{DQA} = 550\text{ mA}$ , $V_{GSB} = 1.6\text{ Vdc}$ , 1880-1920 MHz Bandwidth					
$P_{out}$ @ 1 dB Compression Point, CW	P1dB	—	107	—	W
$P_{out}$ @ 3 dB Compression Point, CW	P3dB	—	160	—	W
IMD Symmetry @ 40 W PEP, $P_{out}$ where IMD Third Order Intermodulation $\cong 30\text{ dBc}$ (Delta IMD Third Order Intermodulation between Upper and Lower Sidebands > 2 dB)	IMD <sub>sym</sub>	—	13	—	MHz
VBW Resonance Point (IMD Third Order Intermodulation Inflection Point)	VBW <sub>res</sub>	—	50	—	MHz
Gain Flatness in 40 MHz Bandwidth @ $P_{out} = 37\text{ W Avg.}$	$G_F$	—	0.2	—	dB
Gain Variation over Temperature ( $-30^\circ\text{C}$ to $+85^\circ\text{C}$ )	$\Delta G$	—	0.01	—	dB/ $^\circ\text{C}$
Output Power Variation over Temperature ( $-30^\circ\text{C}$ to $+85^\circ\text{C}$ )	$\Delta P_{1dB}$	—	0.009	—	dB/ $^\circ\text{C}$

**Typical Broadband Performance — 2025 MHz** <sup>(1)</sup> (In Freescale 2025 Doherty Test Fixture, 50 ohm system)  $V_{DD} = 28\text{ Vdc}$ ,  $I_{DQA} = 550\text{ mA}$ ,  $V_{GSB} = 1.6\text{ Vdc}$ ,  $P_{out} = 37\text{ W Avg.}$ ,  $f = 2025\text{ MHz}$ , Single-Carrier W-CDMA, IQ Magnitude Clipping, Input Signal PAR = 9.9 dB @ 0.01% Probability on CCDF. ACPR measured in 3.84 MHz Channel Bandwidth @  $\pm 5\text{ MHz}$  Offset.

Frequency	$G_{ps}$ (dB)	$\eta_D$ (%)	Output PAR (dB)	ACPR (dBc)
2025 MHz	15.3	44.0	6.8	-30.0

1. Measurement made with device in a Symmetrical Doherty configuration.

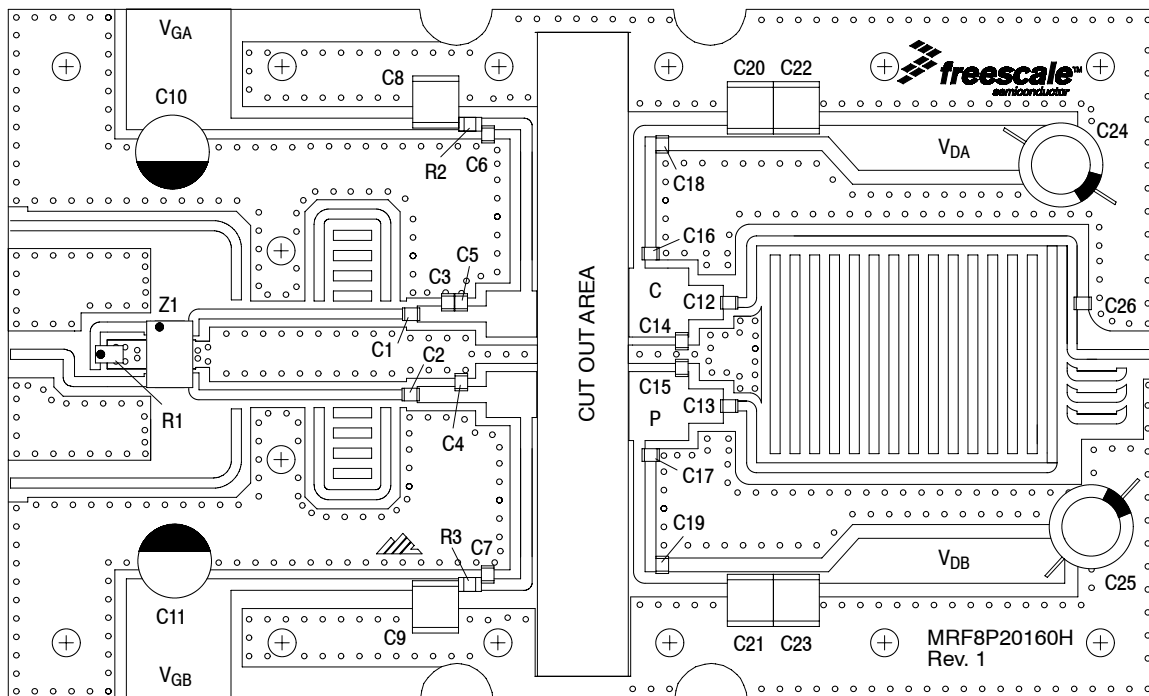
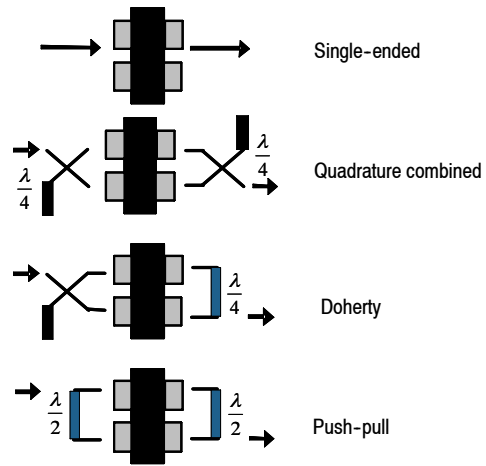


Figure 2. MRF8P20160HR3(HSR3) Test Circuit Component Layout

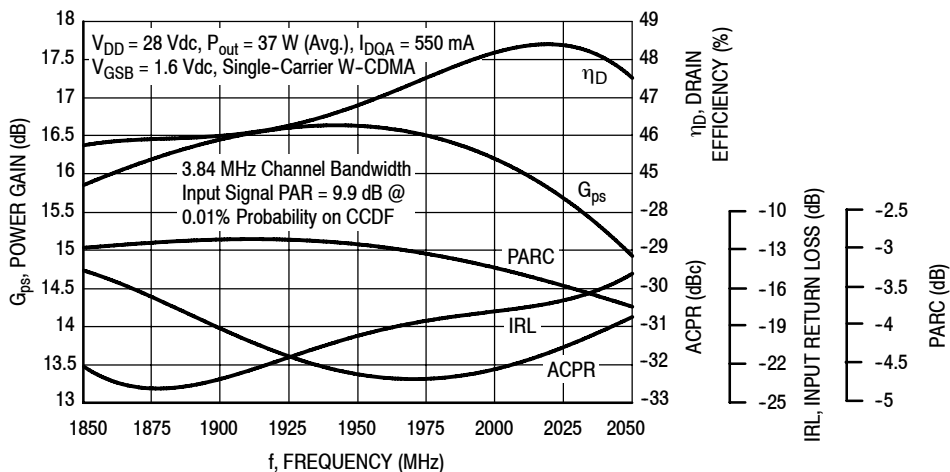
Table 5. MRF8P20160HR3(HSR3) Test Circuit Component Designations and Values

Part	Description	Part Number	Manufacturer
C1, C2, C12, C13	10 pF Chip Capacitors	ATC600F100JT250XT	ATC
C3	0.3 pF Chip Capacitor	ATC600F0R3BT250XT	ATC
C4, C5	1.1 pF Chip Capacitors	ATC600F1R1BT250XT	ATC
C6, C7, C18, C19	12 pF Chip Capacitors	ATC600F120JT250XT	ATC
C8, C9, C20, C21, C22, C23	10 $\mu$ F, 50 V Chip Capacitors	GRM55DR61H106KA88L	Murata
C10, C11	22 $\mu$ F, 35 V Tantalum Capacitors	T491X226K035AT	Kemet
C14, C15	2.0 pF Chip Capacitors	ATC600F2R0BT250XT	ATC
C16, C17	2.2 pF Chip Capacitors	ATC600F2R2BT250XT	ATC
C24, C25	220 $\mu$ F, 50 V Electrolytic Capacitors	227CKS505M	Illinois Cap
C26	0.8 pF Chip Capacitor	ATC600F0R8BT250XT	ATC
R1	50 $\Omega$ , 4 W Chip Resistor	CW12010T0050GBK	ATC
R2, R3	8.25 $\Omega$ , 1/4 W Chip Resistors	CRCW12068R25FKEA	Vishay
Z1	1900 MHz Band 90°, 3 dB Chip Hybrid Coupler	GCS351-HYB1900	Soshin
PCB	0.020", $\epsilon_r = 3.5$	RO4350B	Rogers

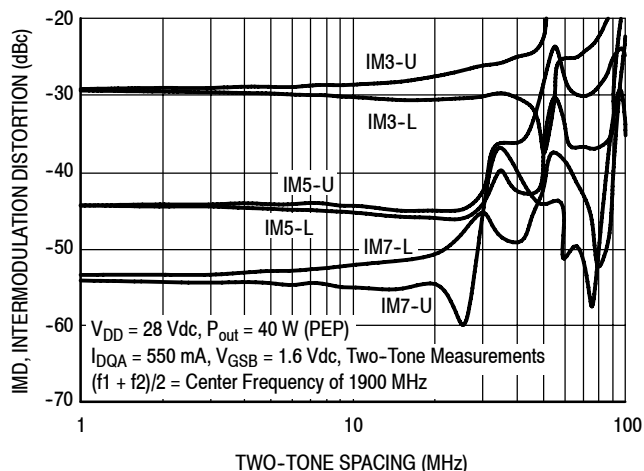


**Figure 3. Possible Circuit Topologies**

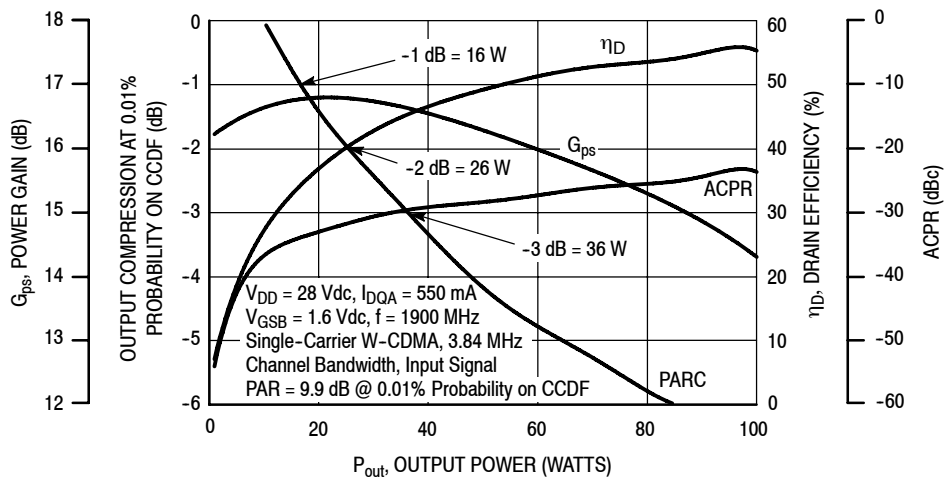
### TYPICAL CHARACTERISTICS



**Figure 4. Output Peak-to-Average Ratio Compression (PARC) Broadband Performance @ P<sub>out</sub> = 37 Watts Avg.**

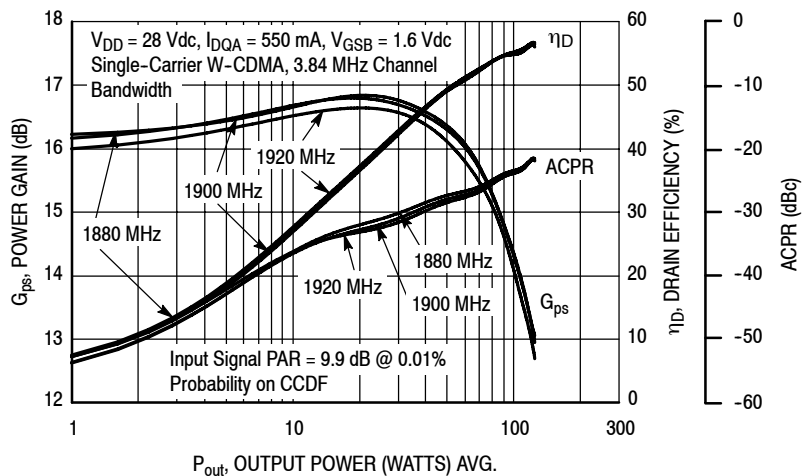


**Figure 5. Intermodulation Distortion Products versus Two-Tone Spacing**

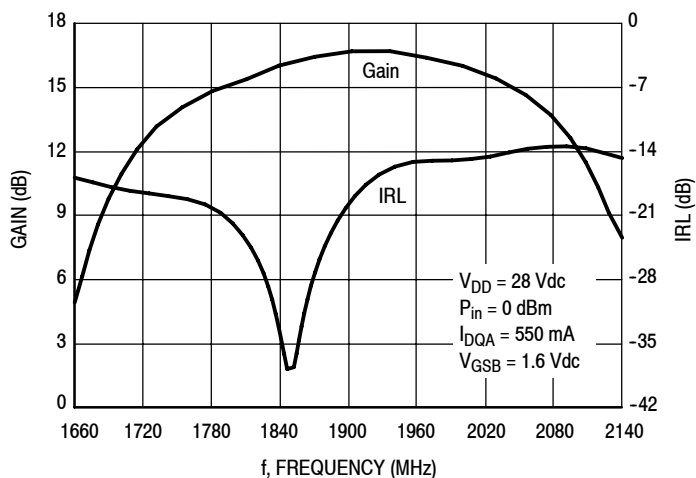


**Figure 6. Output Peak-to-Average Ratio Compression (PARC) versus Output Power**

## TYPICAL CHARACTERISTICS

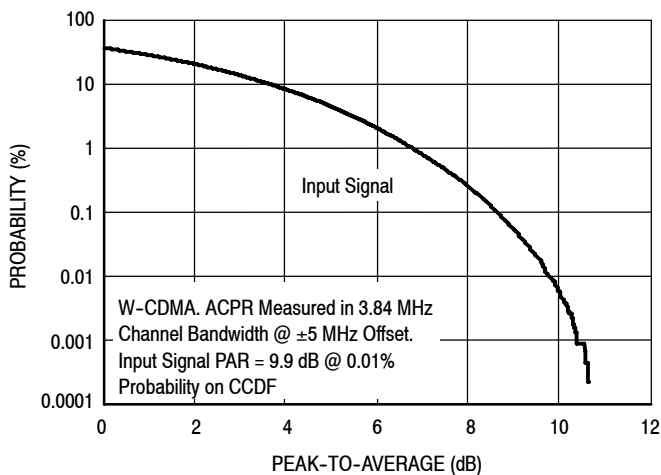


**Figure 7. Single-Carrier W-CDMA Power Gain, Drain Efficiency and ACPR versus Output Power**

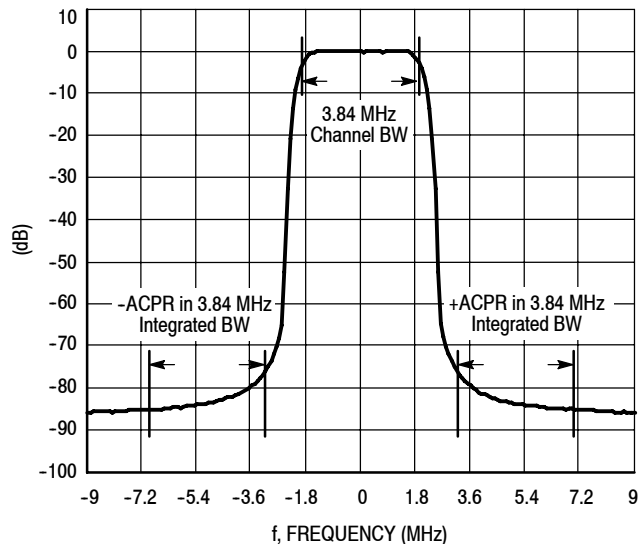


**Figure 8. Broadband Frequency Response**

## W-CDMA TEST SIGNAL



**Figure 9. CCDF W-CDMA IQ Magnitude Clipping, Single-Carrier Test Signal**



**Figure 10. Single-Carrier W-CDMA Spectrum**

$V_{DD} = 28 \text{ Vdc}$ ,  $I_{DQA} = 550 \text{ mA}$

f MHz	Max $P_{out}$ (1)		$Z_{source}$ $\Omega$	$Z_{load}$ $\Omega$
	Watts	dBm		
1880	98	49.9	5.14 - j9.41	1.56 - j5.24
1900	98	49.9	7.59 - j9.88	1.58 - j5.37
1920	97	49.9	8.90 - j9.65	1.57 - j5.48

(1) Maximum output power measurement reflects pulsed 1 dB gain compression.

$Z_{source}$  = Test circuit impedance as measured from gate contact to ground.

$Z_{load}$  = Test circuit impedance as measured from drain contact to ground.

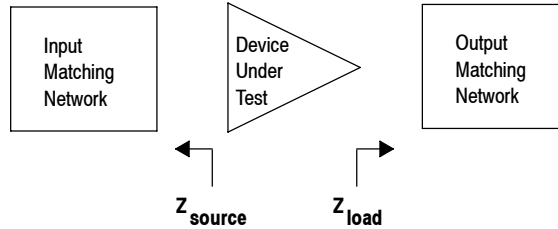


Figure 11. Maximum Output Power — Doherty Load Pull Optimization for Carrier Side

$V_{DD} = 28 \text{ Vdc}$ ,  $I_{DQA} = 550 \text{ mA}$

f MHz	Max Eff. (1) %	$Z_{source}$ $\Omega$	$Z_{load}$ $\Omega$
1880	65.1	5.14 - j9.41	3.04 - j3.65
1900	64.6	7.59 - j9.88	4.13 - j2.87
1920	64.6	8.90 - j9.65	4.12 - j3.15

(1) Maximum efficiency measurement reflects pulsed 1 dB gain compression.

$Z_{source}$  = Test circuit impedance as measured from gate contact to ground.

$Z_{load}$  = Test circuit impedance as measured from drain contact to ground.

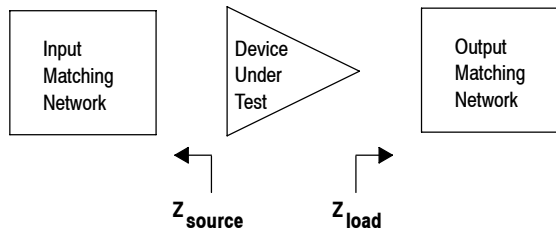
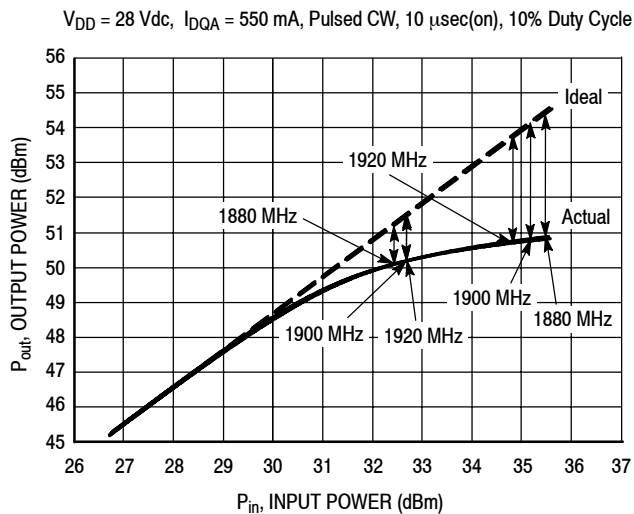


Figure 12. Maximum Efficiency — Doherty Load Pull Optimization for Carrier Side



## ALTERNATIVE PEAK TUNE LOAD PULL CHARACTERISTICS



NOTE: Load Pull Test Fixture Tuned for Peak P1dB Output Power @ 28 V

f (MHz)	P1dB		P3dB	
	Watts	dBm	Watts	dBm
1880	103	50.1	122	50.9
1900	104	50.2	120	50.8
1920	104	50.2	118	50.7

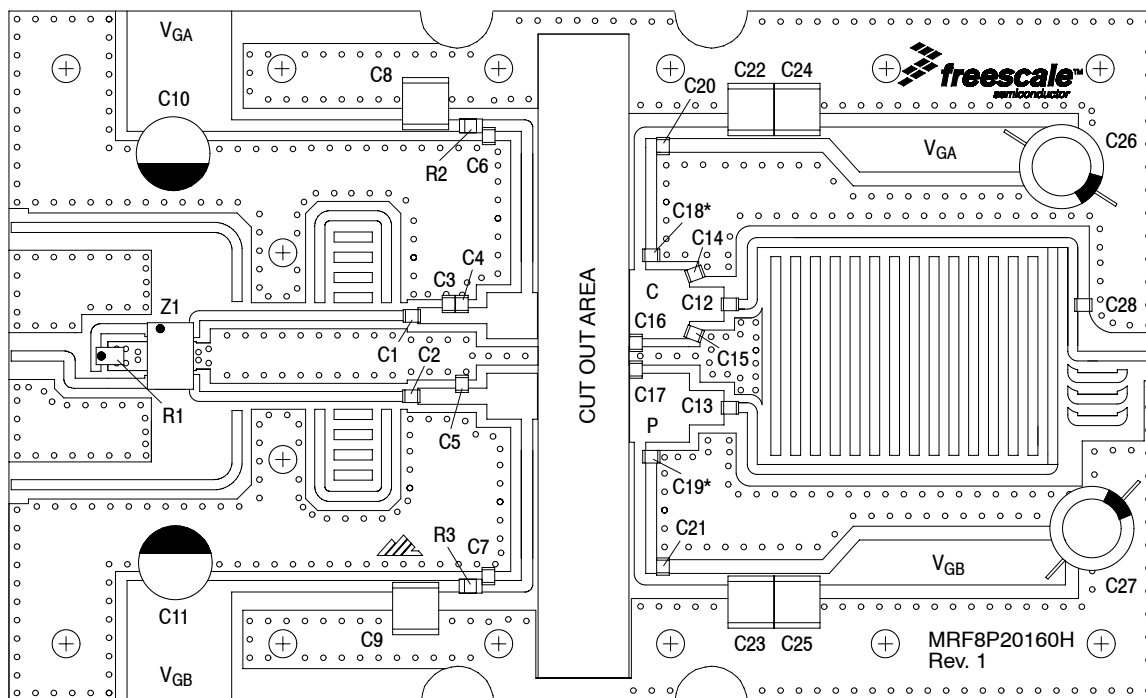
Test Impedances per Compression Level

f (MHz)		$Z_{\text{source}}$ $\Omega$	$Z_{\text{load}}$ $\Omega$
1880	P1dB	5.14 - j9.41	1.65 - j5.46
1900	P1dB	7.59 - j9.88	1.67 - j5.43
1920	P1dB	8.90 - j9.65	1.66 - j5.50

**Figure 13. Pulsed CW Output Power versus Input Power @ 28 V**

NOTE: Measurement made on the Class AB, carrier side of the device.

## ALTERNATE CHARACTERIZATION — 2025 MHz



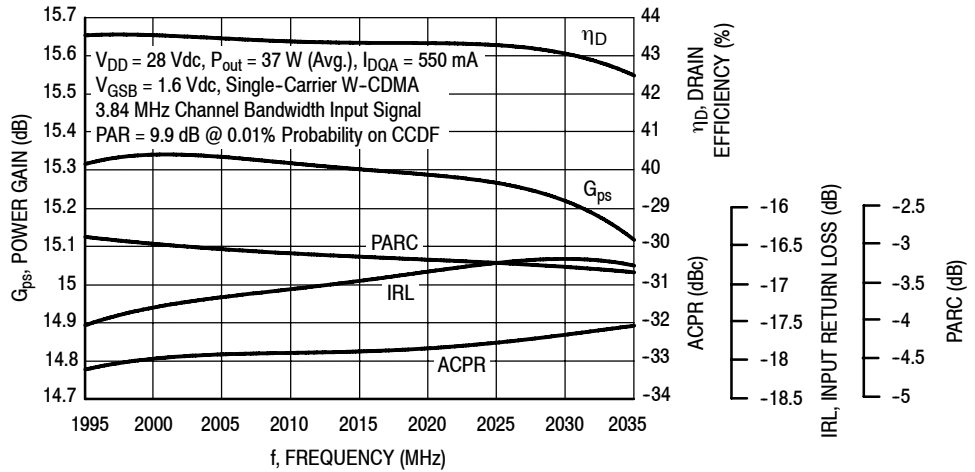
\* Stacked

**Figure 14. MRF8P20160HR3(HSR3) Test Circuit Component Layout — 2025 MHz**

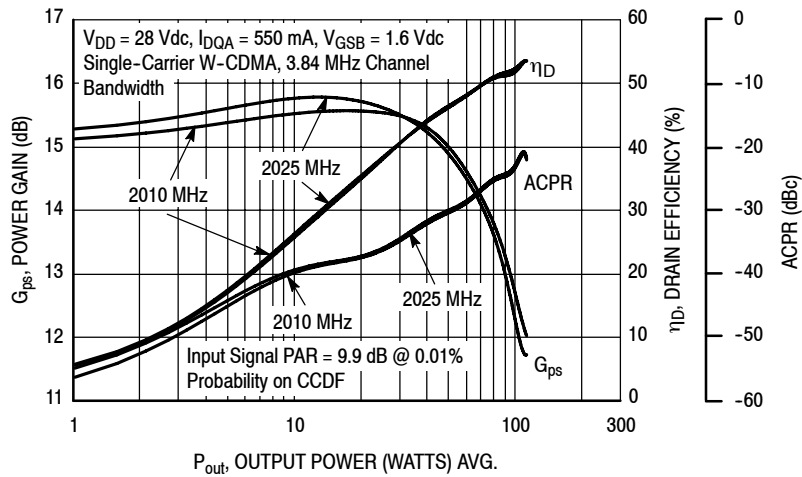
**Table 6. MRF8P20160HR3(HSR3) Test Circuit Component Designations and Values — 2025 MHz**

Part	Description	Part Number	Manufacturer
C1, C2, C6, C7, C12, C13, C20, C21	15 pF Chip Capacitors	ATC600F150JT250XT	ATC
C3, C14, C15	0.3 pF Chip Capacitors	ATC600F0R3BT250XT	ATC
C4, C5	2.4 pF Chip Capacitors	ATC600F2R4BT250XT	ATC
C8, C9, C22, C23, C24, C25	10 $\mu$ F, 50 V Chip Capacitors	GRM55DR61H106KA88L	Murata
C10, C11	22 $\mu$ F, 35 V Tantalum Capacitors	T491X226K035AT	Kemet
C16, C17	0.6 pF Chip Capacitors	ATC600F0R6BT250XT	ATC
C18, C19	1.1 pF Chip Capacitors	ATC600F1R1BT250XT	ATC
C26, C27	220 $\mu$ F, 50 V Electrolytic Capacitors	227CKS505M	Illinois Cap
C28	0.8 pF Chip Capacitors	ATC600F0R8BT250XT	ATC
R1	50 $\Omega$ , 4 W Chip Resistor	CW12010T0050GBK	ATC
R2, R3	8.25 $\Omega$ , 1/4 W Chip Resistors	CRCW12068R25FKEA	Vishay
Z1	1900 MHz Band 90°, 3 dB Chip Hybrid Coupler	GCS351-HYB1900	Soshin
PCB	0.020", $\epsilon_r = 3.5$	RO4350B	Rogers

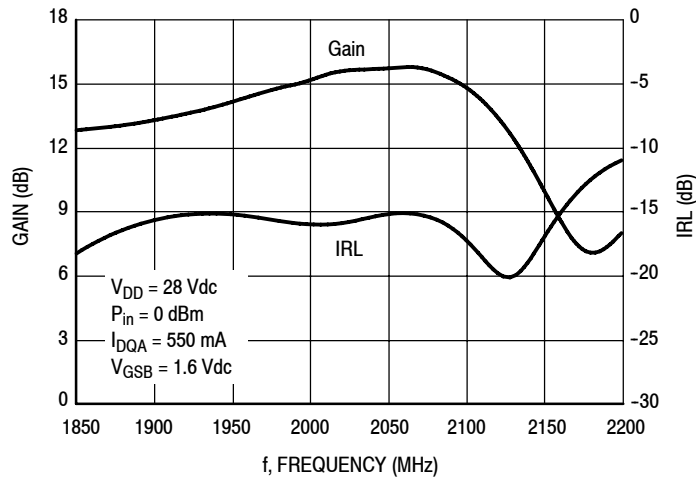
### TYPICAL CHARACTERISTICS — 2025 MHz



**Figure 15. Output Peak-to-Average Ratio Compression (PARC) Broadband Performance @  $P_{out} = 20$  Watts Avg.**

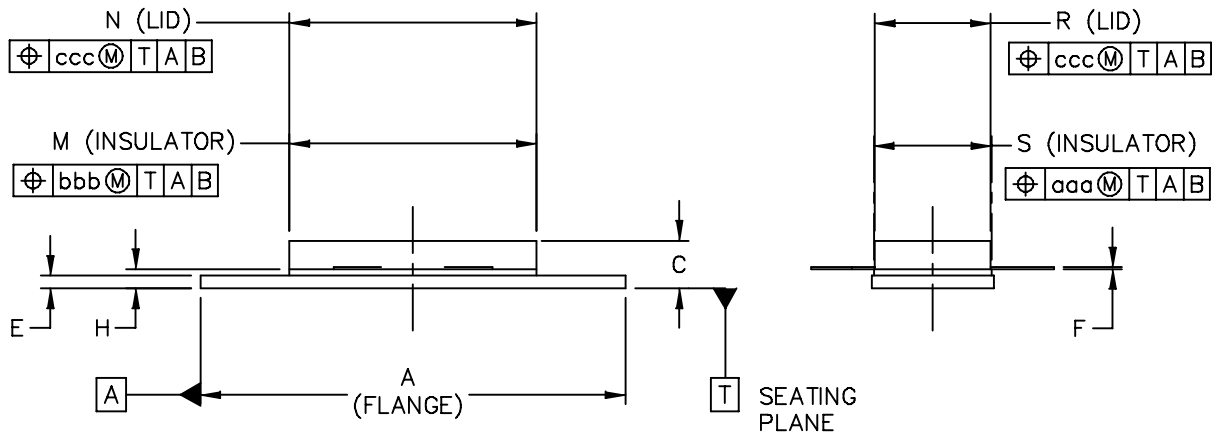
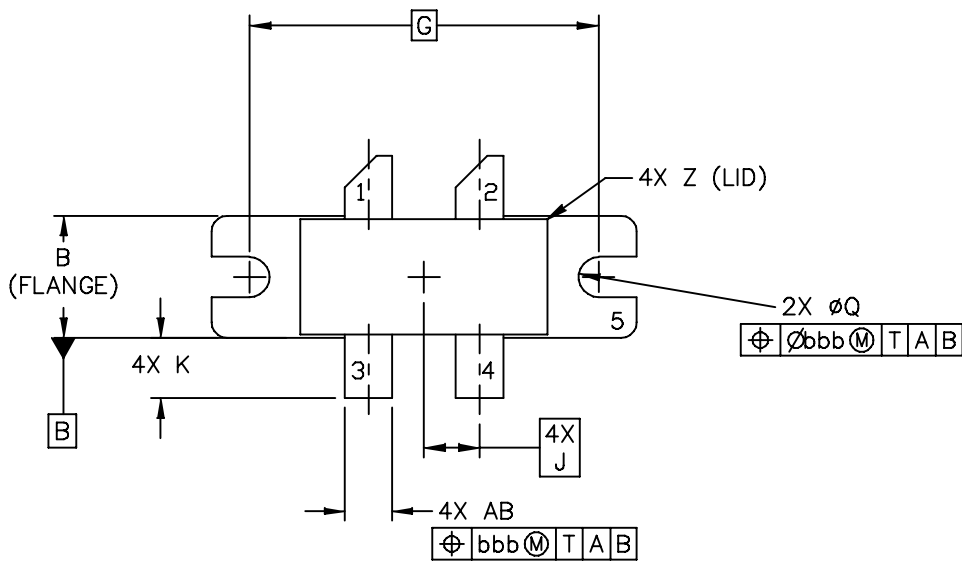


**Figure 16. Single-Carrier W-CDMA Power Gain, Drain Efficiency and ACPR versus Output Power**



**Figure 17. Broadband Frequency Response**

### PACKAGE DIMENSIONS



© FREESCALE SEMICONDUCTOR, INC. ALL RIGHTS RESERVED.	MECHANICAL OUTLINE	PRINT VERSION NOT TO SCALE
TITLE:  NI 780-4	DOCUMENT NO: 98ASA10793D	REV: 0
	CASE NUMBER: 465M-01	27 MAR 2007
	STANDARD: NON-JEDEC	

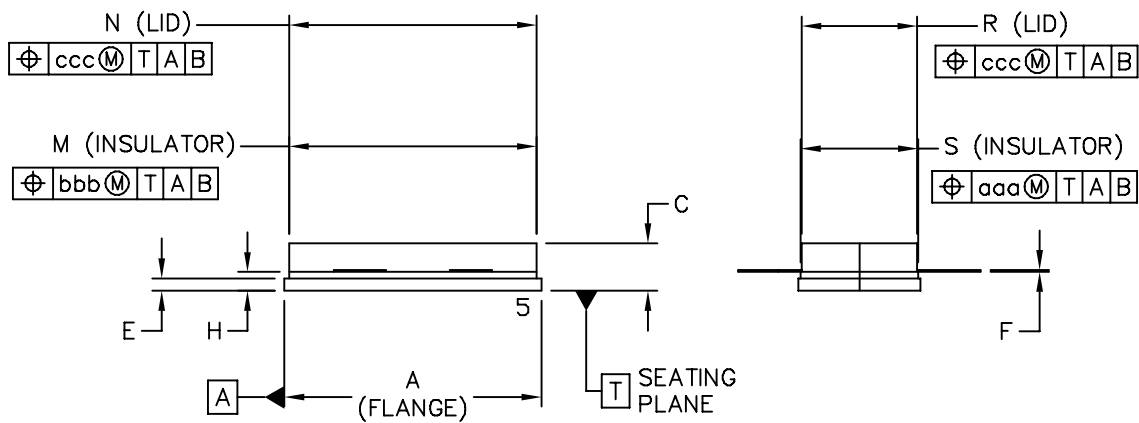
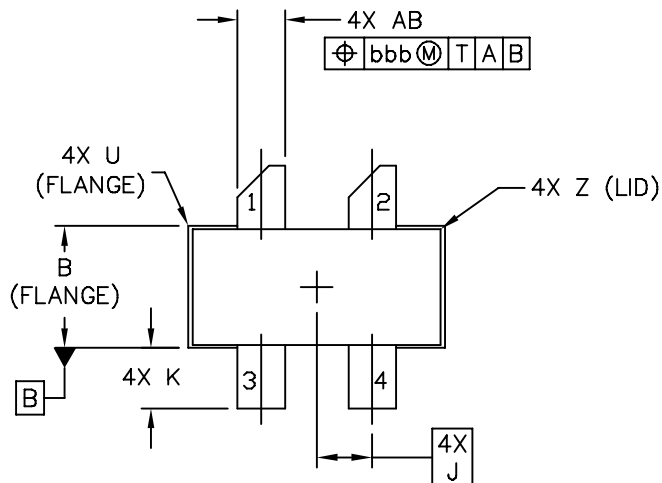
NOTES:

1. DIMENSIONING AND TOLERANCING PER ANSI Y14.5M-1994.
2. CONTROLLING DIMENSION: INCH.
3. DIMENSION H IS MEASURED .030 (0.762) AWAY FROM PACKAGE BODY.

STYLE 1:

- PIN 1. DRAIN  
 2. DRAIN  
 3. GATE  
 4. GATE  
 5. SOURCE

DIM	INCH		MILLIMETER		DIM	INCH		MILLIMETER	
	MIN	MAX	MIN	MAX		MIN	MAX	MIN	MAX
A	1.335	1.345	33.91	34.16	R	.365	.375	9.27	9.53
B	.380	.390	9.65	9.91	S	.365	.375	9.27	9.52
C	.125	.170	3.18	4.32	U		.040		1.02
E	.035	.045	0.89	1.14	Z		.030		0.76
F	.003	.006	0.08	0.15	AB	.145	.155	3.68	3.94
G	1.100 BSC		27.94 BSC						
H	.057	.067	1.45	1.7	aaa		.005		0.127
J	.175 BSC		4.44 BSC		bbb		.010		0.254
K	.170	.210	4.32	5.33	ccc		.015		0.381
M	.774	.786	19.61	20.02					
N	.772	.788	19.61	20.02					
Q	Ø.118	Ø.138	Ø3	Ø3.51					
© FREESCALE SEMICONDUCTOR, INC. ALL RIGHTS RESERVED.			MECHANICAL OUTLINE			PRINT VERSION NOT TO SCALE			
TITLE:  NI 780-4					DOCUMENT NO: 98ASA10793D			REV: 0	
					CASE NUMBER: 465M-01			27 MAR 2007	
					STANDARD: NON-JEDEC				



© FREESCALE SEMICONDUCTOR, INC. ALL RIGHTS RESERVED.	<b>MECHANICAL OUTLINE</b>	PRINT VERSION NOT TO SCALE	
TITLE:  NI 780S-4	DOCUMENT NO: 98ASA10718D	REV: A	
	CASE NUMBER: 465H-02	27 MAR 2007	
	STANDARD: NON-JEDEC		

NOTES:

1. DIMENSIONING AND TOLERANCING PER ANSI Y14.5M-1994.
2. CONTROLLING DIMENSION: INCH.
3. DELETED
4. DIMENSION H IS MEASURED .030 (0.762) AWAY FROM PACKAGE BODY.

STYLE 1:

- PIN 1. DRAIN
2. DRAIN
3. GATE
4. GATE
5. SOURCE

DIM	INCH		MILLIMETER		DIM	INCH		MILLIMETER	
	MIN	MAX	MIN	MAX		MIN	MAX	MIN	MAX
A	.805	.815	20.45	20.7	U		.040		1.02
B	.380	.390	9.65	9.91	Z		.030		0.76
C	.125	.170	3.18	4.32	AB	.145	.155	3.68	– 3.94
E	.035	.045	0.89	1.14					
F	.003	.006	0.08	0.15	aaa		.005		0.127
H	.057	.067	1.45	1.7	bbb		.010		0.254
J	.175 BSC		4.44 BSC		ccc		.015		0.381
K	.170	.210	4.32	5.33					
M	.774	.786	19.61	20.02					
N	.772	.788	19.61	20.02					
R	.365	.375	9.27	9.53					
S	.365	.375	9.27	9.52					
© FREESCALE SEMICONDUCTOR, INC. ALL RIGHTS RESERVED.			<b>MECHANICAL OUTLINE</b>			PRINT VERSION NOT TO SCALE			
TITLE:  NI 780S-4					DOCUMENT NO: 98ASA10718D			REV: A	
					CASE NUMBER: 465H-02			27 MAR 2007	
					STANDARD: NON-JEDEC				

## PRODUCT DOCUMENTATION AND SOFTWARE

Refer to the following documents, tools and software to aid your design process.

### Application Notes

- AN1955: Thermal Measurement Methodology of RF Power Amplifiers

### Engineering Bulletins

- EB212: Using Data Sheet Impedances for RF LDMOS Devices

### Software

- Electromigration MTTF Calculator
- RF High Power Model
- .s2p File

For Software, do a Part Number search at <http://www.freescale.com>, and select the “Part Number” link. Go to the Software & Tools tab on the part’s Product Summary page to download the respective tool.

## REVISION HISTORY

The following table summarizes revisions to this document.

Revision	Date	Description
0	Apr. 2010	<ul style="list-style-type: none"><li>• Initial Release of Data Sheet</li></ul>
1	July 2010	<ul style="list-style-type: none"><li>• Added part number MRF8P20160HR3 (NI-780-4), p. 1</li><li>• Corrected <math>I_{DQ1A}</math> value from 554 to 550 mA in Thermal Characteristics table and changed thermal resistance value from 0.95 to 0.75°C/W. Thermal value now reflects the use of the combined dissipated power from the carrier amplifier and peaking amplifier, p. 2</li><li>• Changed <math>V_{DS(on)}</math> values from 0.05 to 0.1 Min, 0.11 to 0.27 Typ and 0.15 to 0.5 Max. Revised numbers reflect per side measurement versus previous combined measurements, p. 2</li><li>• Replaced Fig. 4, Output Peak-to-Average Ratio Compression (PARC) Broadband Performance @ <math>P_{out} = 37</math> Watts Avg. to show a wider bandwidth capability, p. 6</li><li>• Replaced Fig. 15, Output Peak-to-Average Ratio Compression (PARC) Broadband Performance @ <math>P_{out} = 20</math> Watts Avg. to show more detailed RF performance capability, p. 11</li></ul>



## ***How to Reach Us:***

### **Home Page:**

[www.freescale.com](http://www.freescale.com)

### **Web Support:**

<http://www.freescale.com/support>

### **USA/Europe or Locations Not Listed:**

Freescale Semiconductor, Inc.  
Technical Information Center, EL516  
2100 East Elliot Road  
Tempe, Arizona 85284  
1-800-521-6274 or +1-480-768-2130  
[www.freescale.com/support](http://www.freescale.com/support)

### **Europe, Middle East, and Africa:**

Freescale Halbleiter Deutschland GmbH  
Technical Information Center  
Schatzbogen 7  
81829 Muenchen, Germany  
+44 1296 380 456 (English)  
+46 8 52200080 (English)  
+49 89 92103 559 (German)  
+33 1 69 35 48 48 (French)  
[www.freescale.com/support](http://www.freescale.com/support)

### **Japan:**

Freescale Semiconductor Japan Ltd.  
Headquarters  
ARCO Tower 15F  
1-8-1, Shimo-Meguro, Meguro-ku,  
Tokyo 153-0064  
Japan  
0120 191014 or +81 3 5437 9125  
[support.japan@freescale.com](mailto:support.japan@freescale.com)

### **Asia/Pacific:**

Freescale Semiconductor China Ltd.  
Exchange Building 23F  
No. 118 Jianguo Road  
Chaoyang District  
Beijing 100022  
China  
+86 10 5879 8000  
[support.asia@freescale.com](mailto:support.asia@freescale.com)

### **For Literature Requests Only:**

Freescale Semiconductor Literature Distribution Center  
1-800-441-2447 or +1-303-675-2140  
Fax: +1-303-675-2150  
[LDCForFreescaleSemiconductor@hibbertgroup.com](mailto:LDCForFreescaleSemiconductor@hibbertgroup.com)

Information in this document is provided solely to enable system and software implementers to use Freescale Semiconductor products. There are no express or implied copyright licenses granted hereunder to design or fabricate any integrated circuits or integrated circuits based on the information in this document.

Freescale Semiconductor reserves the right to make changes without further notice to any products herein. Freescale Semiconductor makes no warranty, representation or guarantee regarding the suitability of its products for any particular purpose, nor does Freescale Semiconductor assume any liability arising out of the application or use of any product or circuit, and specifically disclaims any and all liability, including without limitation consequential or incidental damages. "Typical" parameters that may be provided in Freescale Semiconductor data sheets and/or specifications can and do vary in different applications and actual performance may vary over time. All operating parameters, including "Typicals", must be validated for each customer application by customer's technical experts. Freescale Semiconductor does not convey any license under its patent rights nor the rights of others. Freescale Semiconductor products are not designed, intended, or authorized for use as components in systems intended for surgical implant into the body, or other applications intended to support or sustain life, or for any other application in which the failure of the Freescale Semiconductor product could create a situation where personal injury or death may occur. Should Buyer purchase or use Freescale Semiconductor products for any such unintended or unauthorized application, Buyer shall indemnify and hold Freescale Semiconductor and its officers, employees, subsidiaries, affiliates, and distributors harmless against all claims, costs, damages, and expenses, and reasonable attorney fees arising out of, directly or indirectly, any claim of personal injury or death associated with such unintended or unauthorized use, even if such claim alleges that Freescale Semiconductor was negligent regarding the design or manufacture of the part.

Freescale™ and the Freescale logo are trademarks of Freescale Semiconductor, Inc. All other product or service names are the property of their respective owners.

© Freescale Semiconductor, Inc. 2010. All rights reserved.

